

**FINAL
REMEDIAL INVESTIGATION REPORT
FOR HADNOT POINT INDUSTRIAL AREA
OPERABLE UNIT
SHALLOW SOILS AND
CASTLE HAYNE AQUIFER
CHARACTERIZATION STUDY TO DETERMINE
EXISTENCE AND POSSIBLE MIGRATION
OF SPECIFIC CHEMICALS IN SITU**

VOLUME 2

OVER

**MARINE CORPS BASE
Camp Lejeune, North Carolina**

Contract No. N62470-83-C-6106

Prepared for:

**NAVAL FACILITIES ENGINEERING COMMAND
Atlantic Division**

APRIL 1992

Prepared by:

**ENVIRONMENTAL SCIENCE AND ENGINEERING, INC.
Orlando, Florida**

~~PRELIMINARY~~ FINAL
REMEDIAL INVESTIGATION REPORT
FOR HADNOT POINT INDUSTRIAL AREA

CHARACTERIZATION STUDY TO DETERMINE
EXISTENCE AND POSSIBLE MIGRATION
OF SPECIFIC CHEMICALS IN SITU

VOLUME 2

MARINE CORPS BASE
Camp Lejeune, North Carolina

Contract No. N62470-83-C-6106

Prepared for:

NAVAL FACILITIES ENGINEERING COMMAND
Atlantic Division

DECEMBER 1991

Prepared by:

ENVIRONMENTAL SCIENCE AND ENGINEERING, INC.
Orlando, Florida

4902036-0150

TABLE OF CONTENTS

<u>Section</u>	<u>Title</u>	<u>Page</u>
	EXECUTIVE SUMMARY	
1.0	INTRODUCTION	
	1.1 Purpose of Report	1-1
	1.2 Site Background, Location, and Description	1-2
	1.2.1 MCB Camp Lejeune	1-2
	1.2.2 Hadnot Point Industrial Area	1-2
	1.3 RI Approach and Scope	1-3
	1.4 Report Organization	1-4
2.0	SUMMARY OF INVESTIGATIONS	
	2.1 Verification Step	2-2
	2.2 Characterization Step	2-2
	2.3 Supplemental Characterization	2-3
	2.4 Other Investigations	2-3
3.0	SITE INVESTIGATION	
	3.1 Record Search	3-1
	3.2 Soil Investigation	3-2
	3.2.1 Soil Gas Survey	3-2
	3.2.2 Data Analysis	3-4
	3.2.3 Soil Borings	3-4

TABLE OF CONTENTS
(Continued)

<u>Section</u>	<u>Title</u>	<u>Page</u>
	3.3 Groundwater Investigation	3-6
	3.3.1 Monitor Wells	3-6
	3.3.2 Monitor Well Development	3-12
	3.3.3 Groundwater Sampling	3-18
	3.3.4 Water Level Measurements	3-19
	3.3.5 Well Location and Elevation Survey	3-19
	3.4 Pump Testing	3-19
	3.5 Quality Assurance/Quality Control	3-20
4.0	PHYSICAL CHARACTERIZATION OF STUDY AREA	
	4.1 Topography and Surface Water Drainage	4-1
	4.2 Geology	4-2
	4.2.1 Regional Geology	4-2
	4.2.2 Hadnot Point Industrial Area Geology	4-3
	4.3 Hydrology	4-4
	4.3.1 Regional Hydrology	4-4
	4.3.2 Hadnot Point Industrial Area Hydrology	4-5
	4.3.3 Hydraulic Gradients	4-8
	4.3.4 Hydraulic Conductivity	4-10
	4.4 Meteorology	4-10
5.0	RESULTS OF INVESTIGATION	
	5.1 Records Search	5-1
	5.2 Soils Investigation	5-2
	5.2.1 Soil Gas Survey	5-2
	5.2.2 Soil Borings	5-6
	5.3 Groundwater Investigation	5-10
	5.3.1 Shallow Aquifer	5-15
	5.3.2 Deep Aquifer	5-27

TABLE OF CONTENTS
(Continued)

<u>Section</u>	<u>Title</u>	<u>Page</u>
	5.4 QA/QC Samples	5-37
	5.5 Castle Hayne Aquifer Pump Test	5-40
	5.5.1 Well Construction	5-41
	5.5.2 Pump Test Procedures	5-42
	5.5.3 Pump Test Analysis Methods	5-43
	5.5.4 Pump Test Conclusions	5-44
6.0	SUMMARY AND CONCLUSIONS	
	6.1 Records Search	6-1
	6.2 Soil Investigation	6-1
	6.2.1 Soil Gas Survey	6-1
	6.2.2 Soil Sampling and Analytical Results	6-2
	6.3 Groundwater Investigation	6-4
	6.3.1 Monitor Well Installation	6-4
	6.3.2 Groundwater Sampling	6-4
	6.3.3 Analytical Results	6-5
	6.4 Aquifer Testing	6-8
	6.5 Geohydrology	6-9
	REFERENCES	
	APPENDICES (under Separate Cover)	

LIST OF TABLES

<u>Table</u>	<u>Title</u>	<u>Page</u>
3-1	Hadnot Point Groundwater Field Measurements Summary	3-15
3-2	QA/QC Sample Summary	3-23
4-1	Hadnot Point Water Levels (1/25/91)	4-6
4-2	Hadnot Point Water Levels (2/20/91)	4-7
5-1	Comparison of Analytical Results - Hits Only Shallow Groundwater Monitoring Wells	5-11
5-2	Detected Target Analytes - Characterization Investigation - Water Supply Wells	5-32
5-3	Detected Target Analytes - Supplemental Characterization Investigation - Water Supply Wells	5-34
5-4	Water Supply Wells Construction Detail	5-35

LIST OF FIGURES

<u>Figure</u>	<u>Title</u>	<u>Following Page</u>
1-1	Camp Lejeune Location Map	1-2
1-2	Hadnot Point Industrial Area	1-2
1-3	Other Study Sites Adjacent to HPIA	1-3
2-1	Monitor Wells and Water Supply Wells at Hadnot Point Industrial Area - Confirmatory Study	2-3
3-1	Approximate Soil Boring Locations - Bldg. 902	3-4
3-2	Approximate Soil Boring Locations - Bldg. 1202	3-4
3-3	Approximate Soil Boring Locations - Bldg. 1602	3-4
3-4	New and Existing Monitor Wells at Hadnot Point Industrial Area	3-6
4-1	Surface Water Drainage Subbasins at Hadnot Point, Camp Lejeune	4-1
4-2	Water Quality Classifications for New River, Camp Lejeune	4-2
4-3	Geologic and Hydrogeologic Units in the Coastal Plain of North Carolina	4-3
4-4	Generalized Hydrogeologic Cross-Section - Jones and Onslow Counties, North Carolina	4-4
4-5	Generalized Cross-Section of Hadnot Point Industrial Area	4-4
4-6	Potentiometric Surface - Shallow Wells (2-20-91)	4-5
4-7	Potentiometric Surface - Intermediate Wells (2-20-91)	4-8
4-8	Potentiometric Surface - Deep Wells (2-20-91)	4-8

LIST OF FIGURES
(Continued)

<u>Figure</u>	<u>Title</u>	<u>Following Page</u>
4-9	Regional Climatic Conditions at Camp Lejeune	4-11
5-1	Soil Gas Findings--Bldgs. 901, 902, and 903 - Confirmatory Study	5-3
5-2	Soil Gas Findings--Bldgs. 1101, 1102, 1202, 1300, 1301, and 1302 - Confirmatory Study	5-4
5-3	Soil Gas Findings--Bldgs. 1502, 1601, and 1602 - Confirmatory Study	5-5
5-4	Total VOC Isopleth Map - Shallow Aquifer, Confirmatory Study, Hadnot Point Industrial Area	5-15
5-5	Total VOC Isopleth Map - Shallow Aquifer, Supplemental Confirmatory Study, Hadnot Point Industrial Area	5-15

LIST OF ACRONYMS AND ABBREVIATIONS

CERCLA	Comprehensive Environmental Response, Compensation, and Liability Act
cm/sec	centimeters per second
DPDO	Defense Property Disposal Office
DRMO	Defense Reutilization and Marketing Office
EPA	U.S. Environmental Protection Agency
ESE	Environmental Science and Engineering, Inc.
ft	feet
ft/day	feet per day
ft ² /day	square feet per day
ft BLS	feet below land surface
ft/ft	feet per foot
gal	gallons
GC	gas chromatograph
GC/MS	gas chromatography/mass spectrometry
gpd/ft	gallons per day per foot
gpm	gallons per minute
gpm/ft	gallons per minute per foot
HPIA	Hadnot Point Industrial Area
IAS	Initial Assessment Study
ID	inside diameter
LANTDIV	Naval Facilities Engineering Command, Atlantic Division
MCL	Maximum Contaminant Level

LIST OF ACRONYMS AND ABBREVIATIONS

(Continued, 2 of 2)

MDL	method detection limit
MEK	methylethylketone
mmHg	millimeters of mercury
NEESA	Naval Energy and Environmental Support Activity
O&G	oil and grease
OD	outside diameter
1,1-DCA	1,1-dichloroethane
1,2-DCA	1,2-dichloroethane
1,2-DCE	1,2-dichloroethene
PCB	polychlorinated biphenyl
POL	petroleum, oil, and lubricant
ppb	parts per billion
PVC	polyvinyl chloride
RI/FS	Remedial Investigation/Feasibility Study
SARA	Superfund Amendments and Reauthorization Act
TCE	trichloroethene
TCL	toxic contaminant List (volatile, semi-volatile, pesticides, metals)
TIC	tentatively identified compound
ug/L	microgram per liter
USGS	U.S. Geological Survey
VOC	volatile organic compound

ABBREVIATIONS USED IN ANALYTICAL REPORTS

DI	Dionized water blank
EB	Equipment Rinse Blank
FB	Field Blank
HPGW	Hadnot Point groundwater well (-2 indicates 75 ft well, -3 indicates 150 ft well, all other wells are 25 ft deep)
HPIA	Hadnot Point Industrial Area
HPSO	Hadnot Point soil sample (1990/91 soil borings)
GWDUP	Groundwater duplicate sample
MB	Drilling mud blank
mg/kg	Milligrams per killogram
SB	Soil Boring
ug/L	Micrograms per liter
WS	Water supply well

EPA DATA QUALIFIERS

Inorganic Chemical Data

B	Reported value is < Certified Reportable Detection Limit (CRQL) but > Instrument Detection Limit (IDL)
U	Compound was analyzed for but not detected
E	Value is estimated due to matrix interference
N	Spiked sample recovery not within control limits
W	Post-digestion spike for furnace AA analysis is out of control limits, while sample absorbance is <50% of spike absorbance

Organic Chemical Data

U	Compound was analyzed for but not detected
J	Value is estimated, either for a tentatively identified compound (TIC) or when a compound is present (spectral identification criteria are met, but the value is <CRQL)
B	Analyte found in associated blank as well as in sample
X	Additional flag defined seperately at bottom of analytical report

APPENDIX F
QA/QC SAMPLES
ANALYTICAL RESULTS

CAMP LEJEUNE - HPIA
 INORGANICS IN QA/QC SAMPLES
 Concentration in ug/l (Field Blank and D.I. Water Blank)
 Concentration in mg/kg (Mud Blank)

CHART = QAQCING1

wp8e\qhp-inor.wr1 (1)

METAL/COMPOUND	MB-001	FB-001	DI-001	DI-002	DI-005
Aluminum	21,811.76	126B	23.0U	20.7U	20.7U
Antimony	140.00U	22.0U	22.0U	13.3U	13.3U
Arsenic	21.059U	1.8U	1.8U	1.5U	1.5U
Barium	123.53	1.2B	2.4B	1.7U	4.0B
Beryllium	10.59U	2.1U	2.1U	0.50U	0.50U
Cadmium	0.00U	4.3U	4.3U	4.3U	4.3U
Calcium	122708.95	16400	241B	314B	510B
Chromium	0.00U	5.2U	5.2B	1.5U	1.5U
Cobalt	36.47U	6.4U	6.4U	6.0U	6.0U
Copper	0.00U	3.9B	5.4B	10.7B	9.0B
Iron	28118.35	154	144	85.4B	72.9B
Lead	53.03	1.0U	1.0U	1.7U	1.7U
Magnesium	8541.39	1660B	66.5B	81.5B	70.3B
Manganese	610.60	3.2B	4.6B	1.2U	1.8B
Mercury	0.00U	0.10U	0.10U	0.10U	0.10U
Nickel	0.00U	11.0U	11.0U	4.8	5.2U
Potassium	6116.62	1440B	446U	343U	481B
Selenium	17.18U	1.6U	1.6U	3.4U	3.4U
Silver	4.71U	6.2U	6.2B	1.6U	1.6U
Sodium	13282.68	8240	614B	6.8U	908B
Thallium	0.00U	1.1U	1.1U	4.4U	4.4U
Vanadium	14.12U	4.3U	4.3U	2.4U	2.4U
Zinc	222.36	18.2B	11.0B	21.4	46.8
Cyanide	0.00U	10.0U	10.0U	10.0U	10.0U

PROJECT Camp Lejeune
 PREPARED BY Quay Yuma
 DATE April 1991
 CHECKED BY Ed Knyzel
 DATE 5/14/91
 COMMENTS _____

CAMP LEJEUNE - HPIA
TCLP METALS IN EQUIPMENT BLANKS
Concentration in ug/l

CHART = QAQCTCLP

sy\wp8d\qhp-tclp.wr1 (1)

TCLP METALS	EB-006	EB-007	EB-010
Arsenic	68.00B	52.00B	74.00B
Barium	55.00B	72.00B	85.00BNE
Cadmium	3.00B	5.00B	4.00B
Chromium	4.00B	3.00U	3.00U
Lead	34.00B	27.00U	51.00B
Mercury	0.20U	0.20U	0.20U
Selenium	117.00B	63.00B	63.00U
Silver	4.00B	4.00U	4.00U

PROJECT Camp Lejeune
PREPARED BY Judy Guma
DATE April 1991
CHECKED BY Eil Ruffel
DATE 5/14/91

REVISIONS

CAMP LEJEUNE - HPIA
 PESTICIDES IN QA/QC SAMPLES
 Concentration in ug/l (Field Blank and D.I. Water Blanks)
 Concentration in ug/kg (Mud blank)

CHART = QAQCHPP1

sy\wp8d\qhp-pest.wr1 (1)

PESTICIDE/PCB	MB-001	FB-001	DI-001	DI-002	DI-005
alpha-BHC	600.U	.05U	.05U	.05U	.05U
beta-BHC	600.U	.05U	.05U	.05U	.05U
delta-BHC	600.U	.05U	.05U	.05U	.05U
gamma-BHC (Lindane)	600.U	.05U	.05U	.05U	.05U
Heptachlor	600.U	.05U	.05U	.05U	.05U
Aldrin	54.BJ	.05U	.05U	.05U	.05U
Heptachlor epoxide	600.U	.05U	.05U	.05U	.05U
Endosulfan I	600.U	.05U	.05U	.05U	.05U
Dieldrin	150.BJ	.10U	.10U	.10U	.10U
4,4'-DDE	1200.U	.10U	.10U	.10U	.10U
Endrin	1200.U	.10U	.10U	.10U	.10U
Endosulfan II	1200.U	.10U	.10U	.10U	.10U
4,4'-DDD	1200.U	.10U	.10U	.10U	.10U
Endosulfan sulfate	1200.U	.10U	.10U	.10U	.10U
4,4'-DDT	1200.U	.10U	.10U	.10U	.10U
Methoxychlor	6000.U	.50U	.50U	.50U	.50U
Endrin ketone	1200.U	.10U	.10U	.10U	.10U
alpha-Chlordane	6000.U	.50U	.50U	.50U	.50U
gamma-Chlordane	6000.U	.50U	.50U	.50U	.50U
Toxaphene	12000.U	1.0U	1.0U	1.0U	1.0U
Aroclor-1016	6000.U	.50U	.50U	.50U	.50U
Aroclor-1221	6000.U	.50U	.50U	.50U	.50U
Aroclor-1232	6000.U	.50U	.50U	.50U	.50U
Aroclor-1242	6000.U	.50U	.50U	.50U	.50U
Aroclor-1248	6000.U	.50U	.50U	.50U	.50U
Aroclor-1254	12000.U	1.0U	1.0U	1.0U	1.0U
Aroclor-1260	12000.U	1.0U	1.0U	1.0U	1.0U

PROJECT Camp Lejeune
 PREPARED BY Judy Sherrill
 DATE April 1991
 CHECKED BY Ed Kuybel
 DATE 5/13/91

REMARKS _____

CAMP LEJEUNE - HPIA
 PESTICIDES IN QA/QC SAMPLES
 Concentration in ug/l

CHART = QAQCHPP3

sy\wp8d\qhp-pest.wr1 (3)

PESTICIDE/PCB	EB-006	EB-007	EB-010
alpha-BHC	0.050U	0.050U	0.050U
beta-BHC	0.050U	0.050U	0.050U
delta-BHC	0.050U	0.050U	0.050U
gamma-BHC (Lindane)	0.050U	0.050U	0.050U
Heptachlor	0.050U	0.050U	0.050U
Aldrin	0.050U	0.050U	0.050U
Heptachlor epoxide	0.050U	0.050U	0.050U
Endosulfan I	0.050U	0.050U	0.050U
Dieldrin	0.10U	0.10U	0.10U
4,4'-DDE	0.10U	0.10U	0.10U
Endrin	0.10U	0.10U	0.10U
Endosulfan II	0.10U	0.10U	0.10U
4,4'-DDD	0.10U	0.10U	0.10U
Endosulfan sulfate	0.10U	0.10U	0.10U
4,4'-DDT	0.10U	0.10U	0.10U
Methoxychlor	0.50U	0.50U	0.50U
Endrin ketone	0.10U	0.10U	0.10U
alpha-Chlordane	0.50U	0.50U	0.50U
gamma-Chlordane	0.50U	0.50U	0.50U
Toxaphene	1.0U	1.0U	1.0U
Aroclor-1016	0.50U	0.50U	0.50U
Aroclor-1221	0.50U	0.50U	0.50U
Aroclor-1232	0.50U	0.50U	0.50U
Aroclor-1242	0.50U	0.50U	0.50U
Aroclor-1248	0.50U	0.50U	0.50U
Aroclor-1254	1.0U	1.0U	1.0U
Aroclor-1260	1.0U	1.0U	1.0U

PROJECT	Camp Lejeune
PREPARED BY	Shelly Luma
DATE	April 1991
CHECKED BY	EL Royal
DATE	5/8/91
COMMENTS	

CAMP LEJEUNE - HPIA
 SEMI-VOLATILE ORGANIC COMPOUNDS IN QA/QC SAMPLES
 Concentration in ug/l (Field Blank and D.I. Water Blanks)
 Concentration in ug/kg (Mud Blank)

CHART = QACHPS1A

wp8c\qhp-sv.wr1 (1-A)

COMPOUND	MB-001	FB-001	DI-001	DI-002	DI-005
Phenol	39000.U	10.U	10.U	10.U	10.U
bis(2-Chloroethyl)ether	39000.U	10.U	10.U	10.U	10.U
2-Chlorophenol	39000.U	10.U	10.U	10.U	10.U
1,3-Dichlorobenzene	39000.U	10.U	10.U	10.U	10.U
1,4-Dichlorobenzene	39000.U	10.U	10.U	10.U	10.U
Benzyl Alcohol	39000.U	10.U	10.U	10.U	10.U
1,2-Dichlorobenzene	39000.U	10.U	10.U	10.U	10.U
2-Methylphenol	39000.U	10.U	10.U	10.U	10.U
bis(2-Chloroisopropyl)ether	39000.U	10.U	10.U	10.U	10.U
4-Methylphenol	39000.U	10.U	10.U	10.U	10.U
N-Nitroso-di-n-propylamine	39000.U	10.U	10.U	10.U	10.U
Hexachloroethane	39000.U	10.U	10.U	10.U	10.U
Nitrobenzene	39000.U	10.U	10.U	10.U	10.U
Isophorone	39000.U	10.U	10.U	10.U	10.U
2-Nitrophenol	39000.U	10.U	10.U	10.U	10.U
2,4-Dimethylphenol	39000.U	10.U	10.U	10.U	10.U
Benzoic acid	200000.BJ	50.U	50.U	50.U	50.U
bis(2-Chloroethoxy)methane	39000.U	10.U	10.U	10.U	10.U
2,4-Dichlorophenol	39000.U	10.U	10.U	10.U	10.U
1,2,4-Trichlorobenzene	39000.U	10.U	10.U	10.U	10.U
Naphthalene	39000.U	10.U	10.U	10.U	10.U
4-Chloroaniline	39000.U	10.U	10.U	10.U	10.U
Hexachlorobutadiene	39000.U	10.U	10.U	10.U	10.U
4-Chloro-3-methylphenol	39000.U	10.U	10.U	10.U	10.U
2-Methylnaphthalene	39000.U	10.U	10.U	10.U	10.U
Hexachlorocyclopentadiene	39000.U	10.U	10.U	10.U	10.U
2,4,6-Trichlorophenol	39000.U	10.U	10.U	10.U	10.U
2,4,5-Trichlorophenol	200000.BJ	50.U	50.U	50.U	50.U
2-Chloronaphthalene	39000.U	10.U	10.U	10.U	10.U
2-Nitroaniline	200000.BJ	50.U	50.U	50.U	50.U
Dimethylphthalate	39000.U	10.U	10.U	10.U	10.U
Acenaphthylene	39000.U	10.U	10.U	10.U	10.U
2,6-Dinitrotoluene	39000.U	10.U	10.U	10.U	10.U

PROJECT Camp Lejeune
 PREPARED BY Judy Yuma
 DATE April 1991
 CHECKED BY E. J. King
 DATE 5/10/91
 COMMENTS _____

CAMP LEJEUNE - HPIA
 SEMI-VOLATILE ORGANIC COMPOUNDS IN QA/QC SAMPLES
 Concentration in ug/l (Field Blank and D.I. Water Blanks)
 Concentration in ug/kg (Mud Blank)

CHART = QACHPS1B

wp8c\qhp-sv.wr1 (1-B)

COMPOUND	MB-001	FB-001	DI-001	DI-002	DI-005
3-Nitroaniline	200000.U	50.U	50.U	50.U	50.U
Acenaphthene	39000.U	10.U	10.U	10.U	10.U
2,4-Dinitrophenol	200000.U	50.U	50.U	50.U	50.U
4-Nitrophenol	5100.J	50.U	50.U	50.U	50.U
Dibenzofuran	39000.U	10.U	10.U	10.U	10.U
2,4-Dinitrotoluene	39000.U	10.U	10.U	10.U	10.U
Diethylphthalate	39000.U	10.U	10.U	10.U	10.U
4-Chlorophenyl-phenylether	39000.U	10.U	10.U	10.U	10.U
Fluorene	39000.U	10.U	10.U	10.U	10.U
4-Nitroaniline	200000.U	50.U	50.U	50.U	50.U
4,6-Dinitro-2-methylphenol	200000.U	50.U	50.U	50.U	50.U
N-Nitrosodiphenylamine	39000.U	10.U	10.U	10.U	10.U
4-Bromophenyl-phenylether	39000.U	10.U	10.U	10.U	10.U
Hexachlorobenzene	39000.U	10.U	10.U	10.U	10.U
Pentachlorophenol	200000.U	50.U	50.U	50.U	50.U
Phenanthrene	39000.U	10.U	10.U	10.U	10.U
Anthracene	39000.U	10.U	10.U	10.U	10.U
Di-n-butylphthalate	39000.U	10.U	10.U	10.U	10.U
Fluoranthene	39000.U	10.U	10.U	10.U	10.U
Pyrene	1400.J	10.U	10.U	10.U	10.U
Butylbenzylphthalate	61000.	10.U	10.U	10.U	10.U
3,3'-Dichlorobenzidine	78000.	20.U	20.U	20.U	20.U
Benzo(a)anthracene	39000.U	10.U	10.U	10.U	10.U
Chrysene	39000.U	10.U	10.U	10.U	10.U
bis(2-Ethylhexyl)phthalate	200000.BJ	10.U	10.U	10.U	10.U
Di-n-octylphthalate	39000.U	10.U	10.U	10.U	10.U
Benzo(b)fluoranthene	39000.U	10.U	10.U	10.U	10.U
Benzo(k)fluoranthene	39000.U	10.U	10.U	10.U	10.U
Benzo(a)pyrene	39000.U	10.U	10.U	10.U	10.U
Indeno(1,2,3-cd)pyrene	39000.U	10.U	10.U	10.U	10.U
Dibenz(a,h)anthracene	39000.U	10.U	10.U	10.U	10.U
Benzo(g,h,i)perylene	39000.U	10.U	10.U	10.U	10.U

CAMP LEJEUNE - HPIA
SEMI-VOLATILE ORGANIC COMPOUNDS IN QA/QC SAMPLES
Concentration in ug/l

CHART = QACHPS2A

wp8c\qhp-sv.wr1 (2-A)

COMPOUND	EB-001	EB-002	EB-003	EB-004	EB-005	EB-008	EB-011	EB-013
Phenol	10.U	10.U	10U	10U	10U	10U	10U	10.U
bis(2-Chloroethyl)ether	10.U	10.U	10U	10U	10U	10U	10U	10.U
2-Chlorophenol	10.U	10.U	10U	10U	10U	10U	10U	10.U
1,3-Dichlorobenzene	10.U	10.U	10U	10U	10U	10U	10U	10.U
1,4-Dichlorobenzene	10.U	10.U	10U	10U	10U	10U	10U	10.U
Benzyl Alcohol	10.U	10.U	10U	10U	10U	10U	10U	10.U
1,2-Dichlorobenzene	10.U	10.U	10U	10U	10U	10U	10U	10.U
2-Methylphenol	10.U	10.U	10U	10U	10U	10U	10U	10.U
bis(2-Chloroisopropyl)ether	10.U	10.U	10U	10U	10U	10U	10U	10.U
4-Methylphenol	10.U	10.U	10U	10U	10U	10U	10U	10.U
N-Nitroso-di-n-propylamine	10.U	10.U	10U	10U	10U	10U	10U	10.U
Hexachloroethane	10.U	10.U	10U	10U	10U	10U	10U	10.U
Nitrobenzene	10.U	10.U	10U	10U	10U	10U	10U	10.U
Isophorone	10.U	10.U	10U	10U	10U	10U	10U	10.U
2-Nitrophenol	10.U	10.U	10U	10U	10U	10U	10U	10.U
2,4-Dimethylphenol	10.U	10.U	10U	10U	10U	10U	10U	10.U
Benzoic acid	50.U	50.U	50U	50U	50U	50U	50U	50.U
bis(2-Chloroethoxy)methane	10.U	10.U	10U	10U	10U	10U	10U	10.U
2,4-Dichlorophenol	10.U	10.U	10U	10U	10U	10U	10U	10.U
1,2,4-Trichlorobenzene	10.U	10.U	10U	10U	10U	10U	10U	10.U
Naphthalene	10.U	10.U	10U	10U	10U	10U	10U	10.U
4-Chloroaniline	10.U	10.U	10U	10U	10U	10U	10U	10.U
Hexachlorobutadiene	10.U	10.U	10U	10U	10U	10U	10U	10.U
4-Chloro-3-methylphenol	10.U	10.U	10U	10U	10U	10U	10U	10.U
2-Methylnaphthalene	10.U	10.U	10U	10U	10U	10U	10U	10.U
Hexachlorocyclopentadiene	10.U	10.U	10U	10U	10U	10U	10U	10.U
2,4,6-Trichlorophenol	10.U	10.U	10U	10U	10U	10U	10U	10.U
2,4,5-Trichlorophenol	50.U	50.U	50U	50U	50U	50U	50U	50.U
2-Chloronaphthalene	10.U	10.U	10U	10U	10U	10U	10U	10.U
2-Nitroaniline	50.U	50.U	50U	50U	50U	50U	50U	50.U
Dimethylphthalate	10.U	10.U	10U	10U	10U	10U	10U	10.U
Acenaphthylene	10.U	10.U	10U	10U	10U	10U	10U	10.U
2,6-Dinitrotoluene	10.U	10.U	10U	10U	10U	10U	10U	10.U

CAMP LEJEUNE - HPIA
 SEMI-VOLATILE ORGANIC COMPOUNDS IN QA/QC SAMPLES
 Concentration in ug/l

CHART = QACHPS2B

wp8c\hp-sv.wr1 (2-B)

COMPOUND	EB-001	EB-002	EB-003	EB-004	EB-005	EB-008	EB-011	EB-013
3-Nitroaniline	50.U	50.U	50U	50U	50U	50U	50U	50.U
Acenaphthene	10.U	10.U	10U	10U	10U	10U	10U	10.U
2,4-Dinitrophenol	50.U	50.U	50U	50U	50U	50U	50U	50.U
4-Nitrophenol	50.U	50.U	50U	50U	50U	50U	50U	50.U
Dibenzofuran	10.U	10.U	10U	10U	10U	10U	10U	10.U
2,4-Dinitrotoluene	10.U	10.U	10U	10U	10U	10U	10U	10.U
Diethylphthalate	10.U	10.U	10U	10U	10U	10U	10U	10.U
4-Chlorophenyl-phenylether	10.U	10.U	10U	10U	10U	10U	10U	10.U
Fluorene	10.U	10.U	10U	10U	10U	10U	10U	10.U
4-Nitroaniline	50.U	50.U	50U	50U	50U	50U	50U	50.U
4,6-Dinitro-2-methylphenol	50.U	50.U	50U	50U	50U	50U	50U	50.U
N-Nitrosodiphenylamine	10.U	10.U	10U	10U	10U	10U	10U	10.U
4-Bromophenyl-phenylether	10.U	10.U	10U	10U	10U	10U	10U	10.U
Hexachlorobenzene	10.U	10.U	10U	10U	10U	10U	10U	10.U
Pentachlorophenol	50.U	50.U	50U	50U	50U	50U	50U	50.U
Phenanthrene	10.U	10.U	10U	10U	10U	10U	10U	10.U
Anthracene	10.U	10.U	10U	10U	10U	10U	10U	10.U
Di-n-butylphthalate	10.U	10.U	10U	10U	10U	10U	10U	10.U
Fluoranthene	10.U	10.U	10U	10U	10U	10U	10U	10.U
Pyrene	10.U	10.U	10U	10U	10U	10U	10U	10.U
Butylbenzylphthalate	10.U	10.U	10U	10U	10U	10U	10U	10.U
3,3'-Dichlorobenzidine	20.U	20.U	20U	20U	20U	20U	20U	20.U
Benzo(a)anthracene	10.U	10.U	10U	10U	10U	10U	10U	10.U
Chrysene	10.U	10.U	10U	10U	10U	10U	10U	10.U
bis(2-Ethylhexyl)phthalate	10.U	10.U	10U	10U	10U	10U	10U	10.U
Di-n-octylphthalate	10.U	10.U	10U	10U	10U	10U	10U	10.U
Benzo(b)fluoranthene	10.U	10.U	10U	10U	10U	10U	10U	10.U
Benzo(k)fluoranthene	10.U	10.U	10U	10U	10U	10U	10U	10.U
Benzo(a)pyrene	10.U	10.U	10U	10U	10U	10U	10U	10.U
Indeno(1,2,3-cd)pyrene	10.U	10.U	10U	10U	10U	10U	10U	10.U
Dibenz(a,h)anthracene	10.U	10.U	10U	10U	10U	10U	10U	10.U
Benzo(g,h,i)perylene	10.U	10.U	10U	10U	10U	10U	10U	10.U

CAMP LEJEUNE - HPIA
 VOLATILE ORGANIC COMPOUNDS IN MUD BLANKS, FIELD BLANKS, and D.I. WATER BLANKS
 Concentration in ug/l (Field and D.I. Water Blanks)
 Concentration in ug/kg (Mud Blank)

CHART = QAQCHPV1

wp8b\qhp-vol.wr1 (1)

COMPOUND	MB-001	FB-001	DI-001	DI-002	DI-005
Chloromethane	590.U	10.U	10.U	10.U	10.U
Bromomethane	590.U	10.U	10.U	10.U	10.U
Vinyl Chloride	590.U	10.U	10.U	10.U	10.U
Chloroethane	590.U	10.U	10.U	10.U	10.U
Methylene Chloride	1500.	.8J	5.U	5.U	2.J
Acetone	2200.	10.U	10.U	10.U	10.U
Carbon Disulfide	290.U	5.U	5.U	5.U	5.U
1,1-Dichloroethene	290.U	5.U	5.U	5.U	5.U
1,1-Dichloroethane	290.U	5.U	5.U	5.U	5.U
1,2-Dichloroethene (total)	290.U	5.U	5.U	5.U	5.U
Chloroform	600.	7.	5.U	5.U	5.U
1,2-Dichloroethane	290.U	5.U	5.U	5.U	5.U
2-Butanone	590.U	10.U	10.U	10.U	10.U
1,1,1-Trichloroethane	290.U	5.U	5.U	5.U	5.U
Carbon Tetrachloride	290.U	5.U	5.U	5.U	5.U
Vinyl Acetate	590.U	10.U	10.U	10.U	10.U
Bromodichloromethane	190.J	7.	5.U	5.U	5.U
1,2-Dichloropropane	290.U	5.U	5.U	5.U	5.U
cis-1,3-Dichloropropene	290.U	5.U	5.U	5.U	5.U
Trichloroethene	51.J	5.U	5.U	5.U	5.U
Dibromochloromethane	100.J	5.J	5.U	5.U	5.U
1,1,2-Trichloroethane	290.U	5.U	5.U	5.U	5.U
Benzene	430.	5.U	5.U	5.U	5.U
trans-1,3-Dichloropropene	290.U	5.U	5.U	5.U	5.U
Bromoform	290.U	5.U	5.U	5.U	5.U
4-Methyl-2-Pentanone	590.U	10.U	10.U	10.U	10.U
2-Hexanone	590.U	10.U	10.U	10.U	10.U
Tetrachloroethene	290.U	5.U	5.U	5.U	5.U
1,1,2,2-Tetrachloroethane	290.U	5.U	5.U	5.U	5.U
Toluene	4100.	5.U	5.U	5.U	5.U
Chlorobenzene	56.J	5.U	5.U	5.U	5.U
Ethylbenzene	1700.	5.U	5.U	5.U	5.U
Styrene	290.U	5.U	5.U	5.U	5.U
Xylene (total)	7400.	5.U	5.U	5.U	5.U

PROJECT Camp Lejeune

PREPARED BY Shady Shum

DATE April 1991

CHECKED BY Eal King

DATE 5/13/91

COMMENTS

CAMP LEJEUNE - HPIA
 VOLATILE ORGANIC COMPOUNDS IN EQUIPMENT BLANKS
 Concentration in ug/l

CHART = QAQCHPV2

wp8b\qhp-vol.wr1 (2)

COMPOUND	EB-001	EB-002	EB-003	EB-004	EB-005	EB-006	EB-007	EB-008
Chloromethane	10.U	10U	10U	10U	10U	3J	10U	2J
Bromomethane	10.U	10U	10U	10U	10U	10U	10U	10U
Vinyl Chloride	10.U	10U	10U	10U	10U	10U	10U	10U
Chloroethane	10.U	10U	10U	10U	10U	10U	10U	10U
Methylene Chloride	5.U	5U	4J	3J	2BJ	5U	3BJ	5
Acetone	10.U	10U	17	10U	12B	10U	8BJ	12B
Carbon Disulfide	5.U	5U	1J	5U	4J	5U	5U	5
1,1-Dichloroethene	5.U	5U	5U	5U	5U	5U	5U	5U
1,1-Dichloroethane	5.U	5U	5U	5U	5U	5U	5U	5U
1,2-Dichloroethene (total)	5.U	5U	5U	5U	5U	5U	5U	5U
Chloroform	5.U	5U	5U	5U	5U	5U	5U	5U
1,2-Dichloroethane	5.U	5U	5U	5U	5U	5U	5U	5U
2-Butanone	10.U	10U	10U	10U	10U	10U	10U	10U
1,1,1-Trichloroethane	5.U	5U	5U	5U	5U	5U	5U	5U
Carbon Tetrachloride	5.U	5U	5U	5U	5U	5U	5U	5U
Vinyl Acetate	10.U	10U	10U	10U	10U	10U	10U	10U
Bromodichloromethane	5.U	5U	5U	5U	5U	5U	5U	5U
1,2-Dichloropropane	5.U	5U	5U	5U	5U	5U	5U	5U
cis-1,3-Dichloropropene	5.U	5U	5U	5U	5U	5U	5U	5U
Trichloroethene	5.U	5U	5U	5U	5U	5U	5U	5U
Dibromochloromethane	5.U	5U	5U	5U	5U	5U	5U	5U
1,1,2-Trichloroethane	5.U	5U	5U	5U	5U	5U	5U	5U
Benzene	5.U	5U	5U	5U	5U	5U	5U	5U
trans-1,3-Dichloropropene	5.U	5U	5U	5U	5U	5U	5U	5U
Bromoform	5.U	5U	5U	5U	5U	5U	5U	5U
4-Methyl-2-Pentanone	10.U	10U	10U	10U	10U	10U	10U	10U
2-Hexanone	10.U	10U	10U	10U	10U	10U	10U	2J
Tetrachloroethene	5.U	5U	5U	5U	5U	5U	5U	5U
1,1,2,2-Tetrachloroethane	5.U	5U	5U	5U	5U	5U	5U	5U
Toluene	5.U	5U	5U	5U	5U	5U	5U	5U
Chlorobenzene	5.U	5U	5U	5U	5U	5U	5U	5U
Ethylbenzene	5.U	5U	5U	5U	5U	5U	5U	5U
Styrene	5.U	5U	5U	5U	5U	5U	5U	5U
Xylene (total)	5.U	5U	5U	5U	5U	5U	5U	5U

CAMP LEJEUNE - HPIA
VOLATILE ORGANIC COMPOUNDS IN EQUIPMENT BLANKS
Concentration in ug/L

CHART = QAQCHPV3

wp8b\qhp-vol.wr1 (3)

COMPOUND	EB-010	EB-011	EB-013	EB-017
Chloromethane	10U	10U	10.U	10U
Bromomethane	10U	10U	10.U	10U
Vinyl Chloride	10U	10U	10.U	10U
Chloroethane	10U	10U	10.U	10U
Methylene Chloride	2BJ	5U	5.U	6B
Acetone	5BJ	9J	10.U	13
Carbon Disulfide	5U	5U	5.U	1J
1,1-Dichloroethene	5U	5U	5.U	5U
1,1-Dichloroethane	5U	5U	5.U	5U
1,2-Dichloroethene (total)	5U	5U	5.U	5U
Chloroform	5U	5U	5.U	5U
1,2-Dichloroethane	5U	5U	5.U	5U
2-Butanone	10U	10U	10.U	10U
1,1,1-Trichloroethane	5U	5U	5.U	5U
Carbon Tetrachloride	5U	5U	5.U	5U
Vinyl Acetate	10U	10U	10.U	10U
Bromodichloromethane	5U	5U	5.U	5U
1,2-Dichloropropane	5U	5U	5.U	5U
cis-1,3-Dichloropropene	5U	5U	5.U	5U
Trichloroethene	5U	5U	5.U	5U
Dibromochloromethane	5U	5U	5.U	5U
1,1,2-Trichloroethane	5U	5U	5.U	5U
Benzene	5U	5U	3.J	5U
trans-1,3-Dichloropropene	5U	5U	5.U	5U
Bromoform	5U	5U	5.U	5U
4-Methyl-2-Pentanone	10U	10U	10.U	10U
2-Hexanone	10U	10U	10.U	10U
Tetrachloroethene	5U	5U	5.U	5U
1,1,2,2-Tetrachloroethane	5U	5U	5.U	5U
Toluene	5U	5U	10.	5U
Chlorobenzene	5U	5U	5.U	5U
Ethylbenzene	5U	5U	2.J	5U
Styrene	5U	5U	5.U	5U
Xylene (total)	5U	5U	10.	5U

PROJECT	<i>Camp Lejeune</i>	PREPARED BY	<i>Guilly & Guma</i>	DATE	<i>April 1991</i>
CHECKED BY	<i>Ed Kuyfel</i>	DATE	<i>5/8/91</i>	COMMENTS	

CAMP LEJEUNE - HPIA
VOLATILE ORGANIC COMPOUNDS IN TRIP BLANKS
Concentration in ug/l

CHART = QAQCHPV5

wp8b\qhp-vol.wr1 (5)

COMPOUND	TB-011	TB-012	TB-013	TB-015
Chloromethane	10.U	10.U	10.U	10.U
Bromomethane	10.U	10.U	10.U	10.U
Vinyl Chloride	10.U	10.U	10.U	10.U
Chloroethane	10.U	10.U	10.U	10.U
Methylene Chloride	5.U	5.U	5.U	5.U
Acetone	10.U	10.U	10.U	12.
Carbon Disulfide	5.U	5.U	5.U	5.U
1,1-Dichloroethene	5.U	5.U	5.U	5.U
1,1-Dichloroethane	5.U	5.U	5.U	5.U
1,2-Dichloroethene (total)	5.U	5.U	5.U	5.U
Chloroform	5.U	5.U	5.U	5.U
1,2-Dichloroethane	5.U	5.U	5.U	5.U
2-Butanone	10.U	10.U	10.U	10.U
1,1,1-Trichloroethane	5.U	5.U	5.U	5.U
Carbon Tetrachloride	5.U	5.U	5.U	5.U
Vinyl Acetate	10.U	10.U	10.U	10.U
Bromodichloromethane	5.U	5.U	5.U	5.U
1,2-Dichloropropane	5.U	5.U	5.U	5.U
cis-1,3-Dichloropropene	5.U	5.U	5.U	5.U
Trichloroethene	5.U	5.U	5.U	5.U
Dibromochloromethane	5.U	5.U	5.U	5.U
1,1,2-Trichloroethane	5.U	5.U	5.U	5.U
Benzene	5.U	5.U	5.U	5.U
trans-1,3-Dichloropropene	5.U	5.U	5.U	5.U
Bromoform	5.U	5.U	5.U	5.U
4-Methyl-2-Pentanone	10.U	10.U	10.U	10.U
2-Hexanone	10.U	10.U	10.U	10.U
Tetrachloroethene	5.U	5.U	5.U	5.U
1,1,2,2-Tetrachloroethane	5.U	5.U	5.U	5.U
Toluene	5.U	3.U	5.U	5.U
Chlorobenzene	5.U	5.U	5.U	5.U
Ethylbenzene	5.U	5.U	5.U	5.U
Styrene	5.U	5.U	5.U	5.U
Xylene (total)	5.U	5.U	5.U	5.U

PROJECT	<u>Camp Lejeune</u>
PREPARED BY	<u>Justin Guma</u>
DATE	<u>April 1991</u>
CHECKED BY	<u>ED Krystal</u>
DATE	<u>5/14/91</u>

CAMP LEJEUNE - HPIA
 VOLATILE ORGANIC COMPOUNDS IN EQUIPMENT BLANK
 Concentration in ug/L

CHART = SOIL-EB

COMPOUND	EB017
Chloromethane	10U
Bromomethane	10U
Vinyl Chloride	10U
Chloroethane	10U
Methylene Chloride	6B
Acetone	13
Carbon Disulfide	1J
1,1-Dichloroethene	5U
1,1-Dichloroethane	5U
1,2-Dichloroethene (total)	5U
Chloroform	5U
1,2-Dichloroethane	5U
2-Butanone	10U
1,1,1-Trichloroethane	5U
Carbon Tetrachloride	5U
Vinyl Acetate	10U
Bromodichloromethane	5U
1,2-Dichloropropane	5U
cis-1,3-Dichloropropene	5U
Trichloroethene	5U
Dibromochloromethane	5U
1,1,2-Trichloroethane	5U
Benzene	5U
trans-1,3-Dichloropropene	5U
Bromoform	5U
4-Methyl-2-Pentanone	10U
2-Hexanone	10U
Tetrachloroethene	5U
1,1,2,2-Tetrachloroethane	5U
Toluene	5U
Chlorobenzene	5U
Ethylbenzene	5U
Styrene	5U
Total Xylenes	5U

PROJECT	<u>Camp Lejeune</u>	PREPARED BY	<u>J. J. Bunka</u>
DATE	<u>May 19 91</u>	CHECKED BY	<u>E.C. King</u>
DATE	<u>5/16/91</u>	COMMENTS	

CAMP LEJEUNE - HPIA
 PESTICIDES IN EPA SOIL SPIKE SAMPLES
 Concentration in ug/kg

CHART = SOIL-PEP

PESTICIDE/PCB	EPA-3	EPA-4
	SOSP03 SOIL SPIKE	SOSP04 SOIL SPIKE
alpha-BHC	8.9U	8.7U
beta-BHC	8.9U	8.7U
delta-BHC	8.9U	8.7U
gamma-BHC (Lindane)	8.9U	8.7U
Heptachlor	8.9U	8.7U
Aldrin	8.9U	8.7U
Heptachlor epoxide	8.9U	8.7U
Endosulfan I	8.9U	8.7U
Dieldrin	18U	17U
4,4'-DDE	18U	17U
Endrin	18U	17U
Endosulfan II	18U	17U
4,4'-DDD	18U	17U
Endosulfan sulfate	18U	17U
4,4'-DDT	18U	17U
Methoxychlor	89U	87U
Endrin ketone	18U	17U
alpha-Chlordane	89U	87U
gamma-Chlordane	89U	87U
Toxaphene	180U	170U
Aroclor-1016	89U	87U
Aroclor-1221	89U	87U
Aroclor-1232	89U	87U
Aroclor-1242	89U	87U
Aroclor-1248	89U	87U
Aroclor-1254	180U	170U
Aroclor-1260	180U	170U

PROJECT	<u>Camp Lejeune</u>
PREPARED BY	<u>Ed Kuyper</u>
DATE	<u>5/91</u>
CHECKED BY	<u>Judy Yuma</u>
DATE	<u>5-21-91</u>

CAMP LEJEUNE - HPIA
TCLP METALS IN EPA SOIL SPIKE SAMPLES
Concentration in ug/l

CHART = EPASOIL-1

TCLP METALS	EPA-3 SOSP03 soil spike
Arsenic	98.00B*
Barium	95.00BE
Cadmium	3.00U
Chromium	10.00B
Lead	36.00B
Mercury	0.20U
Selenium	100.00B
Silver	4.00U

PROJECT

Camp Lejeune

PREPARED BY

Judith Guma

DATE

May 1991

CHECKED BY

ED Knyfel

DATE

5/21/91

COMMENTS

APPENDIX G

**QA/QC
DISCUSSION OF RESULTS**



Environmental
Science &
Engineering, Inc.

April 22, 1991

Environmental Science
& Engineering
201 Route 17 North
Rutherford, NJ 07070

The purpose of this letter is to present you with the results of my examination of the field QC sample results for Camp Lejeune. You may recall that earlier this month, you asked me to summarize the results for all field blanks, equipment blanks, trip blanks and field duplicates that were generated for this project. You asked that this information be compiled not only for ESE's water analysis data but also for those field QC samples that were analyzed by CEIMIC. This effort has been completed, and the attached tables contain the extracted field QC data as taken from the data packages generated by ESE and CEIMIC. In the paragraphs below I will present my observations as to the significance of the values seen in this data.

Equipment Blanks

The water equipment blanks did not show significant levels of contamination for any analyte except for iron. This is not unexpected since iron is a ubiquitous element in the environment, and could have come from the sampling equipment. There was one equipment blank (EB-001) that showed a relatively high concentration of iron, and a small amount of cyanide. Zinc showed up once in blank EB-009, which is also not surprising, since it too is a ubiquitous element in nature, and is an occasional laboratory contaminant at trace levels. All blanks were free of detectable levels of organics except for one that had low levels of toluene and xylenes.

The soil equipment blanks showed a wider range of metals present, with cadmium, iron and zinc predominant. There was a notable value for sodium reported in blank EB-011. This is well above what might be expected for possible laboratory contamination, and its presence in the absence of any other target analytes is puzzling. Blank EB-012 seemed to have the highest number of metal contaminants, and the highest concentrations as well. Again, it appears that there was no organic contamination present in the blanks. The values for acetone, methylene chloride and carbon disulfide that are reported for the two blanks are very near the detection limits. In addition, acetone and methylene chloride are ubiquitous laboratory contaminants, and I would closely examine the laboratory VOA's blanks for the presence of these compounds before I would describe the presence of these analytes in the blank a result of field operations.

Trip Blanks

These field QC samples were only generated for water samples, and are analyzed only for volatiles. Only three trip blanks showed values above the detection limits for GC/MS volatiles analysis, and all analysis results were very close to the method's detection limits. The value for acetone is just over twice the method's detection limit for that analyte, and you should be aware that since it is a common laboratory contaminant, the CLP protocol allows laboratory blank values to be up to five (5) times the detection limit before the laboratory has to take corrective action. In general, these blanks look very clean.

D.I. Blanks

These field QC samples were only generated for water samples only, and were collected each time a new batch of deionized water was received by the field team. Analysis of this water showed low levels of zinc and iron for only three of these blanks. No other inorganic or organic target analytes were found in these samples.

Field Blanks

Field blanks were only generated for water analysis, and came from the potable water supply that was used for general cleaning/support operations in the field. Only one field blank was generated, and both organic and inorganic analyses were performed on this sample. There were substantial amounts of calcium, iron and sodium present in the blank, and trace levels of chloroform and bromodichloromethane. These last two organics are common materials in municipal water supplies, and are formed as a result of the chlorination of water to kill bacteria.

Sample Duplicates

Sample duplicate data has been summarized for both the water (ESE) and soil analyses (CHEIMIC). The water values show an astonishing variety in the analysis results between pairs of duplicate samples. In some cases (eg. sample HPGW12 and it's duplicate) there is a tremendous variability between the two analysis results. For other samples (eg. sample HPGW-4 and it's duplicate) the agreement between the two samples is excellent.

The only explanation for this variability in the water analyses comes from a physical inspection of the water samples themselves. In most cases where there is a substantial difference between the two analyses, there is a substantial difference in the amount of sediment contained in the two samples. For some duplicate pairs, one sample will be very cloudy and murky and the other sample will be crystal clear. Whenever both samples of the duplicate pairs were relatively clear and free of suspended sediment, the duplicate sample analyses results showed good agreement.

The soil analysis results are about what is expected for the analysis of soil matrices. The high variability seen between water duplicates is not present, but shows the same RPD values from sample to sample. The RPD's are in the 40% to 80% range for a number of analytes, which would be unacceptable for water analyses but are not unexpected when dealing with typical non-uniform environmental soils.

This completes my review of field QC data that is available to me for this project. I assume that there are samples in the data set that are field spikes or reference materials that have been submitted to the laboratories as blind field spikes, but of course I have no information available that allows me to evaluate the accuracy and precision of the analysis results for these samples. I hope that this review and my comments are useful to you, and if you have any questions on this matter please call me at your earliest convenience.

Sincerely,

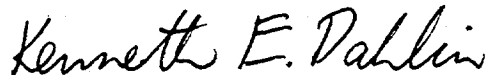

Kenneth E. Dahlin
Quality Assurance Supervisor

ATTACHMENTS

EQUIPMENT BLANKS

The following contaminants were found in the equipment blanks analyzed by ESE.

INORGANIC ANALYSIS			ORGANIC ANALYSIS		
<u>Sample ID</u>	<u>Analyte</u>	<u>Conc. UG/L</u>	<u>Sample ID</u>	<u>Analyte</u>	<u>Conc. UG/L</u>
EB-001	Iron	888.0	EB-013	Toluene	10.0
	Cyanide	15.0		Xylene(T)	10.0
EB-002	Iron	145.0			
EB-009	Iron	119.0			
	Zinc	58.0			

The following contaminants were found in the equipment blank analyzed by CEIMIC.

INORGANIC ANALYSIS			ORGANIC ANALYSIS		
<u>Sample ID</u>	<u>Analyte</u>	<u>Conc. UG/L</u>	<u>Sample ID</u>	<u>Analyte</u>	<u>Conc. UG/L</u>
EB-003	Cadmium	5.0	EB-003	Acetone	17.0
	Zinc	20.0	EB-008	Methylene Chloride	5.0
EB-004	Cadmium	6.0		Carbon Disulfide	5.0
	Iron	174.0			
	Zinc	24.0			
EB-005	Cadmium	5.0			
	Iron	119.0			
	Zinc	23.0			
EB-008	Cadmium	11.0			
	Iron	208.0			
	Zinc	28.0			
EB-011	Sodium	401000.0			
EB-012	Beryllium	5.0			
	Chromium	12.0			
	Iron	356.0			
	Nickel	73.0			
	Zinc	1210.0			

TRIP BLANKS

The following contaminants were found in the trip blanks analyzed by ESE.

ORGANIC ANALYSIS

<u>Sample ID</u>	<u>Analyte</u>	<u>Conc. UG/L</u>
TB-002	1,2 Dichloro-ethene (T)	7.0
TB-006	Carbon Disulfide	8.0
TB-015	Acetone	12.0

DI BLANKS

The following contaminants were found in the DI blanks analyzed by ESE.

INORGANIC ANALYSIS

<u>Sample ID</u>	<u>Analyte</u>	<u>Conc. UG/L</u>
DI-001	Iron	144.0
DI-002	Zinc	21.4
DI-005	Zinc	46.8

FIELD BLANKS

The following contaminants were found in the field blanks analyzed by ESE.

INORGANIC ANALYSIS

<u>Sample ID</u>	<u>Analyte</u>	<u>Conc. UG/L</u>
FB-001	Calcium	16400.0
	Iron	154.0
	Sodium	8240.0

ORGANIC ANALYSIS

<u>Sample ID</u>	<u>Analyte</u>	<u>Conc. UG/L</u>
FB-001	Chloroform	7.0
	Bromodichloro- methane	7.0

SAMPLE DUPLICATE
ESE

Sample ID	HPGW12 Sample Conc. UG/L ¹	GWDUP2 Dup. Conc. UG/L	RPD %
Aluminum	24000.00	2110.00	167.7
Antimony	U 22.0	U 22.0	----
Arsenic	U 1.80	U 1.80	----
Barium	91.50	46.30	65.6
Beryllium	U 2.10	U 2.10	----
Cadmium	U 4.30	U 4.30	----
Calcium	34100.0	170000.0	133.2
Chromium	25.50	U 5.20	----
Cobalt	6.40	U 6.40	----
Copper	5.90	3.20	59.3
Iron	5600.00	100.00	193.0
Lead	15.70	U 1.00	----
Magnesium	7700.00	119.00	193.9
Manganese	18.30	U 1.80	----
Mercury	U 0.10	U 0.10	----
Nickel	U 11.0	U 11.0	----
Potassium	2600.00	5280.00	68.0
Selenium	5.80	U 1.60	----
Silver	U 6.20	U 6.20	----
Sodium	9310.00	6560.00	34.7
Thallium	U 1.10	U 1.10	----
Vanadium	31.10	6.60	130.0
Zinc	46.60	44.60	4.4
Cyanide	U 10.0	U 10.0	----

Sample ID	HPGW9-3 Sample Conc. UG/L	GWDUP3 Dup. Conc. UG/L	RPD %
Aluminum	2200.00	19000.00	158.5
Antimony	U 22.0	U 22.0	----
Arsenic	U 1.80	2.40	----
Barium	49.10	88.80	57.6
Beryllium	U 2.10	U 2.10	----
Cadmium	U 4.30	U 4.30	----
Calcium	120000.0	33200.0	113.3
Chromium	U 5.20	25.60	----
Cobalt	U 6.40	8.40	----
Copper	4.60	12.20	90.5
Iron	149.00	4490.00	187.2
Lead	U 1.00	12.30	----
Magnesium	131.00	7700.00	193.3
Manganese	U 1.80	17.10	----
Mercury	U 0.10	U 0.10	----
Nickel	U 11.0	U 11.0	----
Potassium	5540.00	2990.00	59.8
Selenium	U 1.60	4.00	----
Silver	U 6.20	U 6.20	----
Sodium	6440.00	7040.00	8.9
Thallium	U 1.10	U 1.10	----
Vanadium	7.30	28.80	119.1
Zinc	38.60	40.40	4.6
Cyanide	U 10.0	U 10.0	----

Analyte	Sample ID HPGW30-2 GWDUP4		RPD %
	Sample	Dup.	
	Conc. UG/L	Conc. UG/L	
Aluminum	1860.00	1830.00	1.6
Antimony	U 13.3	U 13.3	----
Arsenic	U 1.50	U 1.50	----
Barium	28.70	19.00	40.7
Beryllium	0.61	0.61	0.0
Cadmium	U 4.30	U 4.30	----
Calcium	138000.0	132000.0	4.4
Chromium	4.90	7.00	35.3
Cobalt	U 6.00	U 6.00	----
Copper	7.30	11.20	42.2
Iron	4950.00	4850.00	2.0
Lead	5.00	6.20	21.4
Magnesium	2350.00	2260.00	3.9
Manganese	51.10	49.00	4.2
Mercury	U 0.10	U 0.10	----
Nickel	U 5.20	U 5.20	----
Potassium	7180.00	7230.00	0.7
Selenium	U 3.40	U 3.40	----
Silver	U 1.60	U 1.60	----
Sodium	18600.00	215000.0	168.2
Thallium	U 4.40	U 4.40	----
Vanadium	5.70	6.10	6.8
Zinc	44.50	61.30	31.8
Cyanide	U 10.0	U 10.0	----

Analyte	Sample ID HPGW-4 GWDUP5		RPD %
	Sample	Dup.	
	Conc. UG/L	Conc. UG/L	
Aluminum	97000.00	96800.00	0.2
Antimony	21.90	34.60	45.0
Arsenic	15.50	19.40	22.3
Barium	268.00	273.00	1.8
Beryllium	6.70	6.40	4.6
Cadmium	U 4.30	U 4.30	----
Calcium	296000.0	310000.0	4.6
Chromium	187.00	195.00	4.2
Cobalt	14.40	18.20	23.3
Copper	35.40	39.20	10.2
Iron	100000.0	106000.0	5.8
Lead	66.60	45.60	37.4
Magnesium	12100.00	12500.00	3.3
Manganese	425.00	436.00	2.6
Mercury	U 0.10	U 0.10	----
Nickel	57.00	64.30	12.0
Potassium	9710.00	9520.00	2.0
Selenium	U 3.40	U 3.40	----
Silver	U 1.60	2.40	----
Sodium	11400.00	11100.00	2.7
Thallium	U 4.40	U 4.40	----
Vanadium	213.00	222.00	4.1
Zinc	228.00	272.00	17.6
Cyanide	U 10.0	U 10.0	----

Sample ID	69GW-8	GWDUP6	
	Sample	Dup.	
Analyte	Conc.	Conc.	RPD
	UG/L	UG/L	%
Aluminum	24100.00	U 20.7	----
Antimony	U 13.3	U 13.3	----
Arsenic	U 1.50	1.80	----
Barium	188.00	2.80	194.1
Beryllium	1.30	0.97	29.1
Cadmium	U 4.30	U 4.30	----
Calcium	7460.00	15.60	199.2
Chromium	22.10	U 1.50	----
Cobalt	U 6.00	U 6.00	----
Copper	7.40	U 3.20	----
Iron	10700.00	63.10	197.7
Lead	20.40	16.40	21.7
Magnesium	3100.00	U 0.00	----
Manganese	168.00	2.00	195.3
Mercury	U 0.10	U 0.10	----
Nickel	5.70	U 5.20	----
Potassium	2510.00	U 343	----
Selenium	U 3.40	U 3.40	----
Silver	2.40	235.00	196.0
Sodium	4880.00	U 6.80	----
Thallium	U 4.40	U 4.40	----
Vanadium	25.60	U 2.40	77.5
Zinc	53.20	11.30	----
Cyanide	U 10.0	U 10.0	----

Sample ID	6-GW-8	GWDUP7	
	Sample	Dup.	
Analyte	Conc.	Conc.	RPD
	UG/L	UG/L	%
Aluminum	332000.0	281000.0	16.6
Antimony	U 13.30	U 13.3	----
Arsenic	6.00	2.90	69.7
Barium	792.00	716.00	10.1
Beryllium	2.90	3.20	9.8
Cadmium	U 4.30	U 4.30	----
Calcium	38200.00	35800.00	6.5
Chromium	342.00	283.00	18.9
Cobalt	15.40	13.70	11.7
Copper	75.80	65.50	14.6
Iron	50400.00	40300.00	22.3
Lead	70.40	63.00	11.1
Magnesium	12300.00	9900.00	21.6
Manganese	157.00	102.00	42.5
Mercury	0.32	0.27	16.9
Nickel	81.60	58.30	33.3
Potassium	14300.00	11700.00	20.0
Selenium	U 3.40	U 3.40	----
Silver	1.80	6.90	117.2
Sodium	2530.00	2410.00	4.9
Thallium	U 0.10	U 4.40	----
Vanadium	274.00	216.00	23.7
Zinc	151.00	120.00	22.9
Cyanide	U 10.0	U 10.0	----

Sample ID	HPGW26	GWDUP8	
Analyte	Sample Conc. UG/L	Dup. Conc. UG/L	RPD %
Aluminum	10400.00	7830.00	28.2
Antimony	U 13.3	U 13.3	----
Arsenic	U 1.50	U 1.50	----
Barium	72.00	67.70	6.2
Beryllium	U 0.50	U 0.50	----
Cadmium	U 4.30	U 4.30	----
Calcium	2830.00	2770.00	2.1
Chromium	13.00	10.30	23.2
Cobalt	U 6.00	U 6.00	----
Copper	9.10	7.20	23.3
Iron	19000.00	10900.00	54.2
Lead	9.00	5.20	53.5
Magnesium	1830.00	1710.00	6.8
Manganese	10.60	8.80	18.6
Mercury	U 0.10	U 0.10	----
Nickel	U 5.20	U 5.20	----
Potassium	2230.00	1580.00	34.1
Selenium	U 3.40	U 3.40	----
Silver	U 1.60	U 1.60	----
Sodium	5910.00	5690.00	3.8
Thallium	U 4.40	U 4.40	----
Vanadium	149.00	83.60	56.2
Zinc	68.10	43.10	45.0
Cyanide	U 10.0	U 10.0	----

Sample ID	WS-634	GWDUP9	
Analyte	Sample Conc. UG/L	Dup. Conc. UG/L	RPD %
Aluminum	U 20.7	U 20.7	----
Antimony	U 13.3	U 13.3	----
Arsenic	U 1.50	U 1.50	----
Barium	10.20	10.40	1.9
Beryllium	U 0.50	0.86	----
Cadmium	U 4.30	U 4.30	----
Calcium	58900.00	61200.00	3.8
Chromium	U 1.50	U 1.50	----
Cobalt	U 6.00	U 6.00	----
Copper	4.90	4.00	20.2
Iron	1420.00	1550.00	8.8
Lead	U 1.70	U 1.70	----
Magnesium	1190.00	1240.00	4.1
Manganese	12.50	12.50	0.0
Mercury	U 0.10	U 0.10	----
Nickel	U 5.20	U 5.20	----
Potassium	890.00	1090.00	20.2
Selenium	U 3.40	U 3.40	----
Silver	U 1.60	U 1.60	----
Sodium	5410.00	5900.00	8.7
Thallium	U 4.40	U 4.40	----
Vanadium	U 2.40	2.50	----
Zinc	23.40	14.30	48.3
Cyanide	U 10.0	U 10.0	----

Sample ID	49SW-1	SWDUP1	
	Sample	Dup.	
Analyte	Conc.	Conc.	RPD
	UG/L	UG/L	%
Aluminum	1180.00	1390.00	16.3
Antimony	U 13.3	U 13.3	----
Arsenic	U 1.50	U 1.50	----
Barium	U 1.70	U 1.70	----
Beryllium	U 0.50	U 0.50	----
Cadmium	U 4.30	U 4.30	----
Calcium	123000.0	140000.0	12.9
Chromium	U 1.50	U 1.50	----
Cobalt	U 6.00	U 6.00	----
Copper	U 3.20	U 3.20	----
Iron	1560.00	1550.00	0.6
Lead	U 1.70	U 1.70	----
Magnesium	343000.0	404000.0	16.3
Manganese	2.60	1.20	73.7
Mercury	U 0.10	U 0.10	----
Nickel	U 5.20	U 5.20	----
Potassium	122000.0	150000.0	20.6
Selenium	U 3.40	U 3.40	----
Silver	3.80	3.30	14.1
Sodium	986000.0	968000.0	1.8
Thallium	U 4.40	U 4.40	----
Vanadium	4.40	4.80	8.7
Zinc	U 2.70	13.00	----
Cyanide	NR	NR	----

Sample ID	6-SW-1	SWDUP2	
	Sample	Dup.	
Analyte	Conc.	Conc.	RPD
	UG/L	UG/L	%
Aluminum	650.00	639.00	1.7
Antimony	U 13.3	13.50	----
Arsenic	U 1.50	U 1.50	----
Barium	13.70	15.00	9.1
Beryllium	U 0.50	U 0.50	----
Cadmium	U 4.30	U 4.30	----
Calcium	6770.00	6850.00	1.2
Chromium	2.60	U 1.50	----
Cobalt	U 6.00	U 6.00	----
Copper	6.40	9.70	41.0
Iron	365.00	365.00	0.0
Lead	U 1.70	U 1.70	----
Magnesium	1160.00	1190.00	2.6
Manganese	8.10	7.50	7.7
Mercury	U 0.10	U 0.10	----
Nickel	U 5.20	U 5.20	----
Potassium	631.00	763.00	18.9
Selenium	U 3.40	U 3.40	----
Silver	18.10	U 1.60	----
Sodium	7210.00	7490.00	3.8
Thallium	U 4.40	U 4.40	----
Vanadium	2.70	2.70	0.0
Zinc	20.80	45.80	75.1
Cyanide	U 10.0	U 10.0	----

1. The "U" qualifier indicates the analyte value was below the instrument detection limit, which is the value listed to the right of the qualifier.

2. Blank RPD values indicate that either the sample or the duplicate or both contained analyte values below the instrument detection limit. Percent values for the RPD cannot be calculated under these circumstances.

SAMPLE DUPLICATE
CEIMIC

Sample ID	HPSO2-2 Sample Conc. UG/L ³	HPSOD-2 Dup. Conc. UG/L	RPD %
Analyte			
Arsenic	75.00	112.00	39.6
Barium	255.00	584.00	78.4
Cadmium	4.00	3.00	28.6
Chromium	3.00	6.00	66.7
Lead	69.00	54.00	24.4
Mercury	U 0.20	U 0.20	----
Selenium	110.00	U 63.00	----
Silver	U 4.00	U 4.00	----

Sample ID	HPSO3-1 Sample Conc. UG/L	HPSOD-3 Dup. Conc. UG/L	RPD %
Analyte			
Arsenic	75.00	92.00	20.4
Barium	382.00	244.00	44.1
Cadmium	27.00	15.00	57.1
Chromium	5.00	4.00	22.2
Lead	79.00	47.00	50.8
Mercury	U 0.20	U 0.20	----
Selenium	76.00	100.00	27.3
Silver	U 4.00	U 4.00	----

Sample ID	HPSO4-2 Sample Conc. UG/L	HPSOD-4 Dup. Conc. UG/L	RPD %
Analyte			
Arsenic	111.00	101.00	9.4
Barium	188.00	166.00	12.4
Cadmium	3.00	3.00	0.0
Chromium	5.00	4.00	22.2
Lead	53.00	50.00	5.8
Mercury	U 0.20	U 0.20	----
Selenium	89.00	168.00	61.5
Silver	U 4.00	U 4.00	----

Sample ID	HPSO11-3 Sample Conc. UG/L	HPSOD-5 Dup. Conc. UG/L	RPD %
Analyte			
Arsenic	81.00	63.00	25.0
Barium	199.00	299.00	40.2
Cadmium	4.00	U 3.00	----
Chromium	7.00	6.00	15.4
Lead	45.00	30.00	40.0
Mercury	U 0.20	1.00	----
Selenium	U 63.00	U 63.00	----
Silver	U 4.00	U 4.00	----

Sample ID	HPSO17-1	HPSOD-6	
Analyte	Sample Conc. UG/L	Dup. Conc. UG/L	RPD %
Arsenic	117.00	102.00	13.7
Barium	331.00	363.00	9.2
Cadmium	4.00	6.00	40.0
Chromium	7.00	6.00	15.4
Lead	59.00	80.00	30.2
Mercury	U 0.20	U 0.20	----
Selenium	U 63.00	84.00	----
Silver	U 4.00	4.00	----

Sample ID	HPSO22-1	HPSOD-7	
Analyte	Sample Conc. UG/L	Dup. Conc. UG/L	RPD %
Arsenic	58.00	111.00	62.7
Barium	320.00	247.00	25.7
Cadmium	U 3.00	U 3.00	----
Chromium	4.00	U 3.00	----
Lead	45.00	46.00	2.2
Mercury	U 0.20	U 0.20	----
Selenium	U 63.00	U 63.00	----
Silver	U 4.00	U 4.00	----

Sample ID	HPSO26-1	HPSOD-8	
Analyte	Sample Conc. UG/L	Dup. Conc. UG/L	RPD %
Arsenic	U 40.00	56.00	----
Barium	596.00	609.00	2.2
Cadmium	U 3.00	U 3.00	----
Chromium	5.00	U 3.00	----
Lead	38.00	47.00	21.2
Mercury	U 0.20	U 0.20	----
Selenium	U 63.00	U 63.00	----
Silver	U 4.00	U 4.00	----

Sample ID	HPSO24-1	HPSOD-9	
Analyte	Sample Conc. UG/L	Dup. Conc. UG/L	RPD %
Arsenic	92.00	554.00	143.0
Barium	137.00	136.00	0.7
Cadmium	3.00	3.00	0.0
Chromium	10.00	7.00	35.3
Lead	U 27.00	37.00	----
Mercury	U 0.20	U 0.20	----
Selenium	100.00	96.00	4.1
Silver	U 4.00	U 4.00	----

Sample ID	HPSO1-1 Sample Conc.	HPSOD-1 Dup. Conc.	RPD %
Analyte	MG/KG	MG/KG	
Aluminum	3590.00	4140.00	14.2
Antimony	U 5.40	5.90	-----
Arsenic	0.55	0.50	9.5
Barium	6.00	6.10	1.7
Beryllium	U 0.20	U 0.16	-----
Cadmium	0.80	U 0.47	-----
Calcium	1450.00	1660.00	13.5
Chromium	5.00	5.00	0.0
Cobalt	1.40	0.93	40.3
Copper	1.40	1.10	24.0
Iron	1790.00	2030.00	12.6
Lead	2.40	3.70	42.6
Magnesium	128.00	116.00	9.8
Manganese	3.80	2.50	41.3
Mercury	U 0.11	U 0.09	-----
Nickel	2.60	1.70	41.9
Potassiu,	124.00	127.00	2.4
Selenium	U 0.16	0.21	-----
Silver	U 0.80	U 0.62	-----
Sodium	120.00	297.00	84.9
Thallium	U 0.16	U 0.17	-----
Vanadium	5.20	6.10	15.9
Zinc	0.80	1.40	54.5
Cyanide	U 0.69	U 0.69	-----

Sample ID	48SE1 Sample Conc.	SEDUP1 Dup. Conc.	RPD %
Analyte	MG/KG	MG/KG	
Aluminum	6130.00	9650.00	44.6
Antimony	U 8.20	U 9.40	-----
Arsenic	5.50	5.70	3.6
Barium	5.20	5.20	0.0
Beryllium	1.20	1.40	15.4
Cadmium	3.00	2.80	6.9
Calcium	1250.00	1280.00	2.4
Chromium	14.00	18.80	29.3
Cobalt	U 1.80	U 2.10	-----
Copper	5.80	5.20	10.9
Iron	16700.00	17900.00	6.9
Lead	13.40	11.50	15.3
Magnesium	1670.00	1840.00	9.7
Manganese	11.90	12.90	8.1
Mercury	U 0.18	U 0.18	-----
Nickel	U 2.70	U 3.10	-----
Potassiu,	1030.00	1200.00	15.2
Selenium	U 0.35	0.42	-----
Silver	U 1.20	U 1.40	-----
Sodium	5850.00	6080.00	3.9
Thallium	U 0.35	U 0.28	-----
Vanadium	29.30	34.40	16.0
Zinc	18.90	22.60	17.8
Cyanide	U 1.10	U 1.10	-----

Sample ID	6SE2	SEDUP2	
Analyte	Sample Conc. MG/KG	Dup. Conc. MG/KG	RPD %
Aluminum	567.00	557.00	1.8
Antimony	U 6.50	U 4.90	----
Arsenic	U 0.35	U 0.36	----
Barium	U 0.48	U 0.36	----
Beryllium	0.97	0.73	28.2
Cadmium	U 0.73	U 0.55	----
Calcium	169.00	165.00	2.4
Chromium	2.70	1.50	57.1
Cobalt	U 1.50	U 1.10	----
Copper	0.73	0.55	28.1
Iron	606.00	644.00	6.1
Lead	1.30	1.10	16.7
Magnesium	72.10	83.50	14.7
Manganese	0.97	0.91	6.4
Mercury	U 0.12	U 0.13	----
Nickel	U 2.20	U 1.6	----
Potassiu,	115.00	86.30	28.5
Selenium	U 0.18	U 0.91	----
Silver	U 0.97	U 0.73	----
Sodium	125.00	159.00	23.9
Thallium	U 0.18	U 0.18	----
Vanadium	0.97	0.55	55.3
Zinc	10.20	0.91	167.2
Cyanide	U 0.75	U 0.83	----

3. The "U" qualifier indicates the analyte value was below the instrument detection limit, which is the value listed to the right of the qualifier.

4. Blank RPD values indicate that either the sample or the duplicate or both contained analyte values below the instrument detection limit. Percent values for the RPD cannot be calculated under these circumstances.

APPENDIX H
ANALYTICAL RESULTS
SOIL SAMPLES

CAMP LEJEUNE HP1A

VOLATILE ORGANIC COMPOUNDS IN SOIL SAMPLES

Concentration in ug/kg

CHART = SOIL-V1

COMPOUND	depth:	SB-1				SB-2		
		HPS01-1	HPS01-1D (HPS0D1)	HPS01-2	HPS01-3	HPS02-1	HPS02-2	HPS02-2D (HPS0D2)
		0-2'	0-2'	2-4'	4-6'	0-2'	2-4'	2-4'
Chloromethane		11U	11U	11U	11U	12U	11U	11U
Bromomethane		11U	11U	11U	11U	12U	11U	11U
Vinyl Chloride		11U	11U	11U	11U	12U	11U	11U
Chloroethane		11U	11U	11U	11U	12U	11U	11U
Methylene Chloride		18J	28J	18J	28J	28J	28J	28J
Acetone		88J	11U	98J	11U	18B	11U	11U
Carbon Disulfide		5U	6U	6U	5U	6U	6U	6U
1,1-Dichloroethene		5U	6U	6U	5U	6U	6U	6U
1,1-Dichloroethane		5U	6U	6U	5U	6U	6U	6U
1,2-Dichloroethene (total)		5U	6U	6U	5U	6U	6U	6U
Chloroform		5U	6U	6U	5U	6U	6U	6U
1,2-Dichloroethane		5U	6U	6U	5U	6U	6U	6U
2-Butanone		11U	11U	11U	11U	12U	11U	11U
1,1,1-Trichloroethane		5U	6U	6U	5U	6U	6U	6U
Carbon Tetrachloride		5U	6U	6U	5U	6U	6U	6U
Vinyl Acetate		11U	11U	11U	11U	12U	11U	11U
Bromodichloromethane		5U	6U	6U	5U	6U	6U	6U
1,2-Dichloropropane		5U	6U	6U	5U	6U	6U	6U
cis-1,3-Dichloropropene		5U	6U	6U	5U	6U	6U	6U
Trichloroethene		5U	6U	6U	5U	6U	6U	6U
Dibromochloromethane		5U	6U	6U	5U	6U	6U	6U
1,1,2-Trichloroethane		5U	6U	6U	5U	6U	6U	6U
Benzene		5U	6U	6U	5U	6U	6U	6U
trans-1,3-Dichloropropene		5U	6U	6U	5U	6U	6U	6U
Bromoform		5U	6U	6U	5U	6U	6U	6U
4-Methyl-2-Pentanone		11U	11U	11U	11U	12U	11U	11U
2-Hexanone		11U	11U	11U	11U	12U	11U	11U
Tetrachloroethene		5U	6U	6U	5U	6U	6U	6U
1,1,2,2-Tetrachloroethane		5U	6U	6U	5U	6U	6U	6U
Toluene		5U	6U	6U	5U	6U	6U	6U
Chlorobenzene		5U	6U	6U	5U	6U	6U	6U
Ethylbenzene		5U	6U	6U	5U	6U	6U	6U
Styrene		5U	6U	6U	5U	6U	6U	6U
Total Xylenes		5U	6U	6U	5U	6U	6U	6U

CAMP LEJEUNE, NC
 VOLATILE ORGANIC COMPOUNDS IN SOIL SAMPLES
 Concentration in ug/kg

CHART = SOIL-V2

COMPOUND	depth:	SB-3		SB-4			
		HPS03-1 0-2'	HPS03-1D (HPS0D-3) 0-2'	HPS04-1 0-2'	HPS04-2 2-4'	HPS04-2D (HPS0D-4) 2-4'	HPS04-3 4-6'
Chloromethane		11U	11U	7BJ	9BJ	12U	11U
Bromomethane		11U	11U	11U	12U	12U	11U
Vinyl Chloride		11U	11U	11U	12U	12U	11U
Chloroethane		11U	11U	11U	12U	12U	11U
Methylene Chloride		2BJ	2BJ	6U	6U	6U	6U
Acetone		11U	11U	5BJ	12U	77B	54B
Carbon Disulfide		5U	5U	6U	6U	6U	6U
1,1-Dichloroethene		5U	5U	6U	6U	6U	6U
1,1-Dichloroethane		5U	5U	6U	6U	6U	6U
1,2-Dichloroethene (total)		5U	5U	6U	6U	6U	6U
Chloroform		5U	5U	6U	6U	6U	6U
1,2-Dichloroethane		5U	5U	6U	6U	6U	6U
2-Butanone		11U	11U	11U	12U	12U	11U
1,1,1-Trichloroethane		5U	5U	6U	6U	6U	6U
Carbon Tetrachloride		5U	5U	6U	6U	6U	6U
Vinyl Acetate		11U	11U	11U	12U	12U	11U
Bromodichloromethane		5U	5U	6U	6U	6U	6U
1,2-Dichloropropane		5U	5U	6U	6U	6U	6U
cis-1,3-Dichloropropene		5U	5U	6U	6U	6U	6U
Trichloroethene		5U	5U	6U	4J	6U	6U
Dibromochloromethane		5U	5U	6U	6U	6U	6U
1,1,2-Trichloroethane		5U	5U	6U	6U	6U	6U
Benzene		5U	5U	6U	6U	6U	6U
trans-1,3-Dichloropropene		5U	5U	6U	6U	6U	6U
Bromoform		5U	5U	6U	6U	6U	6U
4-Methyl-2-Pentanone		11U	11U	11U	12U	12U	11U
2-Hexanone		11U	11U	11U	12U	12U	11U
Tetrachloroethene		5U	5U	6U	6U	6U	6U
1,1,2,2-Tetrachloroethane		5U	5U	6U	6U	6U	6U
Toluene		5U	5U	6U	6U	6U	6U
Chlorobenzene		5U	5U	6U	6U	6U	6U
Ethylbenzene		5U	5U	6U	6U	6U	6U
Styrene		5U	5U	6U	6U	6U	6U
Total Xylenes		5U	5U	6U	6U	6U	6U

CAMP LEJEUNE - HPIA
VOLATILE ORGANIC COMPOUNDS IN SOIL SAMPLES
Concentration in ug/kg

CHART = SOIL-V3

COMPOUND	depth:	SB-5			SB-6		
		HPS05-1	HPS05-2	HPS05-3	HPS06-1	HPS06-2	HPS06-3
		0-2'	2-4'	4-6'	0-2'	2-4'	4-6'
Chloromethane		11U	12U	12U	11U	12U	12U
Bromomethane		11U	12U	12U	11U	12U	12U
Vinyl Chloride		11U	12U	12U	11U	12U	12U
Chloroethane		11U	12U	12U	11U	12U	12U
Methylene Chloride		6U	6U	6U	6U	6U	6U
Acetone		11U	12U	48J	21B	35	13B
Carbon Disulfide		6U	6U	6U	6U	6U	6U
1,1-Dichloroethene		6U	6U	6U	6U	6U	6U
1,1-Dichloroethane		6U	6U	6U	6U	6U	6U
1,2-Dichloroethene (total)		6U	55	120	6U	6U	6U
Chloroform		6U	6U	6U	6U	6U	6U
1,2-Dichloroethane		6U	6U	6U	6U	6U	6U
2-Butanone		11U	12U	12U	11U	12U	12U
1,1,1-Trichloroethane		6U	6U	6U	6U	6U	6U
Carbon Tetrachloride		6U	6U	6U	6U	6U	6U
Vinyl Acetate		11U	12U	12U	11U	12U	12U
Bromodichloromethane		6U	6U	6U	6U	6U	6U
1,2-Dichloropropane		6U	6U	6U	6U	6U	6U
cis-1,3-Dichloropropene		6U	6U	6U	6U	6U	6U
Trichloroethene		6U	6U	120	6U	6U	6U
Dibromochloromethane		6U	6U	6U	6U	6U	6U
1,1,2-Trichloroethane		6U	6U	6U	6U	6U	6U
Benzene		6U	6U	6U	6U	6U	6U
trans-1,3-Dichloropropene		6U	6U	6U	6U	6U	6U
Bromoform		6U	6U	6U	6U	6U	6U
4-Methyl-2-Pentanone		11U	12U	12U	11U	12U	12U
2-Hexanone		11U	12U	12U	11U	12U	12U
Tetrachloroethene		6U	6U	6U	6U	6U	6U
1,1,2,2-Tetrachloroethane		6U	6U	6U	6U	6U	6U
Toluene		6U	10	4J	6U	6U	6U
Chlorobenzene		6U	6U	6U	6U	6U	6U
Ethylbenzene		6U	6U	6U	6U	6U	6U
Styrene		6U	6U	6U	6U	6U	6U
Total Xylenes		6U	6U	6U	6U	6U	6U

PROJECT Camp Lejeune
 PREPARED BY EQ Knight
 DATE 5/9/91
 CHECKED BY Judy Gunn
 DATE 5-15-91
 COMMENTS _____

CAMP LEJEU, HPIA
VOLATILE ORGANIC COMPOUNDS IN SOIL SAMPLES
Concentration in ug/kg

CHART = SOIL-V4

COMPOUND	depth:	SB-7			SB-8		
		HPS07-1	HPS07-2	HPS07-3	HPS08-1	HPS08-2	HPS08-3
		0-2'	2-4'	4-6'	0-2'	2-4'	4-6'
Chloromethane		11U	11U	12U	12U	11U	11U
Bromomethane		11U	11U	12U	12U	11U	11U
Vinyl Chloride		11U	11U	12U	12U	11U	11U
Chloroethane		11U	11U	12U	12U	11U	11U
Methylene Chloride		2BJ	4BJ	2BJ	2BJ	6U	2BJ
Acetone		27B	23B	15B	12U	11U	6J
Carbon Disulfide		6U	6U	6U	6U	6U	6U
1,1-Dichloroethene		6U	6U	6U	6U	6U	6U
1,1-Dichloroethane		6U	6U	6U	6U	6U	6U
1,2-Dichloroethene (total)		6U	6U	6U	6U	6U	6U
Chloroform		6U	6U	6U	6U	6U	6U
1,2-Dichloroethane		6U	6U	6U	6U	6U	6U
2-Butanone		11U	11U	12U	12U	11U	11U
1,1,1-Trichloroethane		6U	6U	6U	6U	6U	6U
Carbon Tetrachloride		6U	6U	6U	6U	6U	6U
Vinyl Acetate		11U	11U	12U	12U	11U	11U
Bromodichloromethane		6U	6U	6U	6U	6U	6U
1,2-Dichloropropane		6U	6U	6U	6U	6U	6U
cis-1,3-Dichloropropene		6U	6U	6U	6U	6U	6U
Trichloroethene		6U	6U	6U	6U	6U	6U
Dibromochloromethane		6U	6U	6U	6U	6U	6U
1,1,2-Trichloroethane		6U	6U	6U	6U	6U	6U
Benzene		6U	6U	6U	6U	6U	6U
trans-1,3-Dichloropropene		6U	6U	6U	6U	6U	6U
Bromoform		6U	6U	6U	6U	6U	6U
4-Methyl-2-Pentanone		11U	11U	12U	12U	11U	11U
2-Hexanone		11U	11U	12U	12U	11U	11U
Tetrachloroethene		6U	6U	6U	6U	6U	6U
1,1,2,2-Tetrachloroethane		6U	6U	6U	6U	6U	6U
Toluene		6U	6U	6U	6U	6U	6U
Chlorobenzene		6U	6U	6U	6U	6U	6U
Ethylbenzene		6U	6U	6U	6U	6U	6U
Styrene		6U	6U	6U	6U	6U	6U
Total Xylenes		6U	6U	6U	6U	6U	6U

*See back
E.K.
5/15/91*

PROJECT

DATE

COMMENTS

CAMP LEJEL. HPIA
VOLATILE ORGANIC COMPOUNDS IN SOIL SAMPLES
Concentration in ug/kg

CHART = SOIL-V5

COMPOUND	depth:	SB-9			SB-10		
		HPS09-1	HPS09-2	HPS09-3	HPS010-1	HPS010-2	HPS010-3
		0-2'	2-4'	4-6'	0-2'	2-4'	4-6'
Chloromethane		11U	11U	12U	12U	12U	12U
Bromomethane		11U	11U	12U	12U	12U	12U
Vinyl Chloride		11U	11U	12U	12U	12U	12U
Chloroethane		11U	11U	12U	12U	12U	12U
Methylene Chloride		6U	2BJ	2BJ	2BJ	2BJ	3BJ
Acetone		6J	20	13	5J	9J	12U
Carbon Disulfide		6U	6U	6U	6U	6U	6U
1,1-Dichloroethene		6U	6U	6U	6U	6U	6U
1,1-Dichloroethane		6U	6U	6U	6U	6U	6U
1,2-Dichloroethene (total)		6U	6U	6U	6U	6U	6U
Chloroform		6U	6U	6U	6U	6U	6U
1,2-Dichloroethane		6U	6U	6U	6U	6U	6U
2-Butanone		11U	11U	12U	12U	12U	12U
1,1,1-Trichloroethane		6U	6U	6U	6U	6U	6U
Carbon Tetrachloride		6U	6U	6U	6U	6U	6U
Vinyl Acetate		11U	11U	12U	12U	12U	12U
Bromodichloromethane		6U	6U	6U	6U	6U	6U
1,2-Dichloropropane		6U	6U	6U	6U	6U	6U
cis-1,3-Dichloropropene		6U	6U	6U	6U	6U	6U
Trichloroethene		6U	6U	6U	6U	6U	6U
Dibromochloromethane		6U	6U	6U	6U	6U	6U
1,1,2-Trichloroethane		6U	6U	6U	6U	6U	6U
Benzene		6U	6U	6U	6U	6U	6U
trans-1,3-Dichloropropene		6U	6U	6U	6U	6U	6U
Bromoform		6U	6U	6U	6U	6U	6U
4-Methyl-2-Pentanone		11U	11U	12U	12U	12U	12U
2-Hexanone		11U	11U	12U	12U	12U	1J
Tetrachloroethene		6U	6U	6U	6U	6U	6U
1,1,2,2-Tetrachloroethane		6U	6U	6U	6U	6U	6U
Toluene		6U	6U	6U	6U	6U	6U
Chlorobenzene		6U	6U	6U	6U	6U	6U
Ethylbenzene		6U	6U	6U	6U	6U	6U
Styrene		6U	6U	6U	6U	6U	6U
Total Xylenes		6U	6U	6U	6U	6U	6U

PROJECT <u>Camp Lejeune</u>
PREPARED BY <u>EC King</u>
DATE <u>5/9/91</u>
CHECKED BY <u>Judy L. ...</u>
DATE <u>5-15-91</u>

COMMENTS

HPIA
CAMP LEJEUNE - HPIA

VOLATILE ORGANIC COMPOUNDS IN SOIL SAMPLES

Concentration in ug/kg

CHART = SOIL-V6

COMPOUND	depth:	SB-11				SB-12		
		HPS011-1	HPS011-2	HPS011-3	HPS011-3D (HPS0D-5)	HPS012-1	HPS012-2	HPS012-3
		0-2'	2-4'	4-6'	4-6'	0-2'	2-4'	8-10'
Chloromethane		11U	11U	12U	12U	11U	11U	11U
Bromomethane		11U	11U	12U	12U	11U	11U	11U
Vinyl Chloride		11U	11U	12U	12U	11U	11U	11U
Chloroethane		11U	11U	12U	12U	11U	11U	11U
Methylene Chloride		5U	6U	2BJ	2BJ	1BJ	3BJ	4BJ
Acetone		360BE	72B	19B	22B	20B	9J	13
Carbon Disulfide		5U	6U	6U	6U	6U	6U	6U
1,1-Dichloroethene		5U	6U	6U	6U	6U	6U	6U
1,1-Dichloroethane		5U	6U	6U	6U	6U	6U	6U
1,2-Dichloroethene (total)		5U	6U	6U	6U	6U	6U	6U
Chloroform		5U	6U	6U	6U	6U	6U	6U
1,2-Dichloroethane		5U	6U	6U	6U	6U	6U	6U
2-Butanone		11U	11U	12U	12U	11U	11U	11U
1,1,1-Trichloroethane		5U	6U	6U	6U	6U	6U	6U
Carbon Tetrachloride		5U	6U	6U	6U	6U	6U	6U
Vinyl Acetate		11U	11U	12U	12U	11U	11U	11U
Bromodichloromethane		5U	6U	6U	6U	6U	6U	6U
1,2-Dichloropropane		5U	6U	6U	6U	6U	6U	6U
cis-1,3-Dichloropropene		5U	6U	6U	6U	6U	6U	6U
Trichloroethene		5U	6U	6U	6U	6U	6U	6U
Dibromochloromethane		5U	6U	6U	6U	6U	6U	6U
1,1,2-Trichloroethane		5U	6U	6U	6U	6U	6U	6U
Benzene		5U	6U	6U	6U	6U	6U	6U
trans-1,3-Dichloropropene		5U	6U	6U	6U	6U	6U	6U
Bromoform		5U	6U	6U	6U	6U	6U	6U
4-Methyl-2-Pentanone		11U	11U	12U	12U	11U	11U	11U
2-Hexanone		11U	11U	12U	12U	11U	11U	11U
Tetrachloroethene		5U	6U	6U	6U	6U	6U	6U
1,1,2,2-Tetrachloroethane		5U	6U	6U	6U	6U	6U	6U
Toluene		5U	6U	6U	6U	6U	6U	6U
Chlorobenzene		5U	6U	3J	1J	6U	6U	6U
Ethylbenzene		5U	6U	6U	6U	6U	6U	6U
Styrene		5U	6U	6U	6U	6U	6U	6U
Total Xylenes		5U	6U	6U	6U	6U	6U	6U

CAMP LEJEL HPIA
VOLATILE ORGANIC COMPOUNDS IN SOIL SAMPLES
Concentration in ug/kg

CHART = SOIL-V7

COMPOUND	depth:	SB-13			SB-14		
		HPSO13-1	HPSO13-2	HPSO13-3	HPSO14-1	HPSO14-2	HPSO14-3
		0-2'	6-8'	8-10'	2-4'	4-6'	8-10'
Chloromethane		11U	11U	12U	11U	11U	60U
Bromomethane		11U	11U	12U	11U	11U	60U
Vinyl Chloride		11U	11U	12U	11U	11U	60U
Chloroethane		11U	11U	12U	11U	11U	60U
Methylene Chloride		4BJ	2BJ	3BJ	3BJ	2BJ	10BJ
Acetone		8BJ	47B	16B	20B	21B	100B
Carbon Disulfide		6U	5U	6U	6U	6U	30U
1,1-Dichloroethene		6U	5U	6U	6U	6U	30U
1,1-Dichloroethane		6U	5U	6U	6U	6U	30U
1,2-Dichloroethene (total)		6U	5U	6U	6U	6U	30U
Chloroform		6U	5U	6U	6U	6U	30U
1,2-Dichloroethane		6U	5U	6U	6U	6U	30U
2-Butanone		11U	11U	12U	11U	11U	60U
1,1,1-Trichloroethane		6U	5U	6U	6U	6U	30U
Carbon Tetrachloride		6U	5U	6U	6U	6U	30U
Vinyl Acetate		11U	11U	12U	11U	11U	60U
Bromodichloromethane		6U	5U	6U	6U	6U	30U
1,2-Dichloropropane		6U	5U	6U	6U	6U	30U
cis-1,3-Dichloropropene		6U	5U	6U	6U	6U	30U
Trichloroethene		6U	5U	6U	6U	6U	30U
Dibromochloromethane		6U	5U	6U	6U	6U	30U
1,1,2-Trichloroethane		6U	5U	6U	6U	6U	30U
Benzene		6U	5U	6U	6U	6U	30U
trans-1,3-Dichloropropene		6U	5U	6U	6U	6U	30U
Bromoform		6U	5U	6U	6U	6U	30U
4-Methyl-2-Pentanone		11U	11U	12U	11U	11U	60U
2-Hexanone		11U	11U	12U	11U	11U	60U
Tetrachloroethene		6U	5U	6U	6U	6U	30U
1,1,2,2-Tetrachloroethane		6U	5U	6U	6U	6U	30U
Toluene		6U	5U	6U	6U	6U	30U
Chlorobenzene		1J	5U	6U	6U	6U	30U
Ethylbenzene		6U	5U	6U	6U	6U	62
Styrene		6U	5U	6U	6U	6U	30U
Total Xylenes		6U	5U	6U	1J	6U	580

PROJECT Camp Lejels
 ANALYZED BY EP King
 DATE 5/9/91
 CHECKED BY Judy Luna
 DATE 5-15-91

CAMP LEJEUNE AFB
VOLATILE ORGANIC COMPOUNDS IN SOIL SAMPLES
Concentration in ug/kg

CHART = SOIL-V8

COMPOUND	depth:	SB-15			SB-16		
		HPS015-1	HPS015-2	HPS015-3	HPS016-1	HPS016-2	HPS016-3
		0-2'	6-8'	8-10'	0-2'	6-8'	8-10'
Chloromethane		11U	11U	11U	11U	11U	12U
Bromomethane		11U	11U	11U	11U	11U	12U
Vinyl Chloride		11U	11U	11U	11U	11U	12U
Chloroethane		11U	11U	11U	11U	11U	12U
Methylene Chloride		3BJ	6U	6U	6U	6U	6U
Acetone		11U	11U	25B	23	15	43
Carbon Disulfide		6U	6U	6U	6U	6U	6U
1,1-Dichloroethene		6U	6U	6U	6U	6U	6U
1,1-Dichloroethane		6U	6U	6U	6U	6U	6U
1,2-Dichloroethene (total)		6U	6U	6U	6U	6U	6U
Chloroform		6U	6U	6U	6U	6U	6U
1,2-Dichloroethane		6U	6U	6U	6U	6U	6U
2-Butanone		11U	11U	11U	11U	11U	12U
1,1,1-Trichloroethane		6U	6U	6U	6U	6U	6U
Carbon Tetrachloride		6U	6U	6U	6U	6U	6U
Vinyl Acetate		11U	11U	11U	11U	11U	12U
Bromodichloromethane		6U	6U	6U	6U	6U	6U
1,2-Dichloropropane		6U	6U	6U	6U	6U	6U
cis-1,3-Dichloropropene		6U	6U	6U	6U	6U	6U
Trichloroethene		2J	6U	6U	2J	6U	3J
Dibromochloromethane		6U	6U	6U	6U	6U	6U
1,1,2-Trichloroethane		6U	6U	6U	6U	6U	6U
Benzene		6U	6U	6U	6U	6U	6U
trans-1,3-Dichloropropene		6U	6U	6U	6U	6U	6U
Bromoform		6U	6U	6U	6U	6U	6U
4-Methyl-2-Pentanone		11U	11U	11U	11U	11U	12U
2-Hexanone		11U	11U	11U	11U	11U	12U
Tetrachloroethene		6U	6U	6U	6U	6U	6U
1,1,2,2-Tetrachloroethane		6U	6U	6U	6U	6U	6U
Toluene		6U	6U	6U	6U	6U	6U
Chlorobenzene		6U	6U	6U	6U	6U	6U
Ethylbenzene		6U	6U	6U	6U	6U	6U
Styrene		6U	6U	6U	6U	6U	6U
Total Xylenes		6U	6U	6U	6U	6U	6U

PROJECT Camp Lejeune
 PREPARED BY E. L. King
 DATE 5/9/91
 CHECKED BY Judy Summa
 DATE 5-15-91

CAMP LEJEUNE 1A
VOLATILE ORGANIC COMPOUNDS IN SOIL SAMPLES
Concentration in ug/kg

CHART = SOIL-V9

COMPOUND	depth:	SB-17				SB-18		
		HPS017-1 0-2'	HPS017-1D (HPS0D6) 0-2'	HPS017-2 6-8'	HPS017-3 8-10'	HPS018-1 4-6'	HPS018-2 6-8'	HPS018-3 8-10'
Chloromethane		11U	11U	11U	12U	11U	11U	11U
Bromomethane		11U	11U	11U	12U	11U	11U	11U
Vinyl Chloride		11U	11U	11U	12U	11U	11U	11U
Chloroethane		11U	11U	11U	12U	11U	11U	11U
Methylene Chloride		6U	5U	5U	3BJ	6U	4BJ	6U
Acetone		12	11U	22	20	59	39	10J
Carbon Disulfide		6U	5U	5U	6U	6U	6U	6U
1,1-Dichloroethene		6U	5U	5U	6U	6U	6U	6U
1,1-Dichloroethane		6U	5U	5U	6U	6U	6U	6U
1,2-Dichloroethene (total)		6U	5U	5U	6U	6U	6U	6U
Chloroform		6U	5U	5U	6U	6U	6U	6U
1,2-Dichloroethane		6U	5U	5U	6U	6U	6U	6U
2-Butanone		11U	11U	11U	12U	11U	11U	11U
1,1,1-Trichloroethane		6U	5U	5U	6U	6U	6U	6U
Carbon Tetrachloride		6U	5U	5U	6U	6U	6U	6U
Vinyl Acetate		11U	11U	11U	12U	11U	11U	11U
Bromodichloromethane		6U	5U	5U	6U	6U	6U	6U
1,2-Dichloropropane		6U	5U	5U	6U	6U	6U	6U
cis-1,3-Dichloropropene		6U	5U	5U	6U	6U	6U	6U
Trichloroethene		6U	5U	5U	6U	6U	6U	6U
Dibromochloromethane		6U	5U	5U	6U	6U	6U	6U
1,1,2-Trichloroethane		6U	5U	5U	6U	6U	6U	6U
Benzene		6U	5U	5U	6U	6U	6U	6U
trans-1,3-Dichloropropene		6U	5U	5U	6U	6U	6U	6U
Bromoform		6U	5U	5U	6U	6U	6U	6U
4-Methyl-2-Pentanone		11U	11U	11U	12U	11U	11U	11U
2-Hexanone		11U	11U	11U	12U	11U	11U	11U
Tetrachloroethene		6U	5U	5U	6U	6U	6U	6U
1,1,2,2-Tetrachloroethane		6U	5U	5U	6U	6U	6U	6U
Toluene		6U	5U	5U	6U	6U	6U	6U
Chlorobenzene		6U	5U	5U	6U	6U	6U	6U
Ethylbenzene		6U	5U	5U	6U	6U	6U	6U
Styrene		6U	5U	5U	6U	6U	6U	6U
Total Xylenes		6U	5U	5U	6U	6U	6U	6U

CAMP LEJEU, APPIA
VOLATILE ORGANIC COMPOUNDS IN SOIL SAMPLES
Concentration in ug/kg

CHART = SOIL-V10

COMPOUND	depth:	SB-19			SB-20		
		HPS019-1	HPS019-2	HPS019-3	HPS020-1	HPS020-2	HPS020-3
		0-2'	2-4'	8-10'	0-2'	6-8'	8-10'
Chloromethane		16U	11U	12U	11U	11U	11U
Bromomethane		16U	11U	12U	11U	11U	11U
Vinyl Chloride		16U	11U	12U	11U	11U	11U
Chloroethane		16U	11U	12U	11U	11U	11U
Methylene Chloride		8U	6U	6U	6U	5U	6U
Acetone		15J	15	12U	19	14	13
Carbon Disulfide		8U	6U	6U	6U	5U	6U
1,1-Dichloroethene		8U	6U	6U	6U	5U	6U
1,1-Dichloroethane		8U	6U	6U	6U	5U	6U
1,2-Dichloroethene (total)		8U	6U	6U	6U	5U	6U
Chloroform		8U	6U	6U	6U	5U	6U
1,2-Dichloroethane		8U	6U	6U	6U	5U	6U
2-Butanone		16U	11U	12U	11U	11U	11U
1,1,1-Trichloroethane		8U	6U	6U	6U	5U	6U
Carbon Tetrachloride		8U	6U	6U	6U	5U	6U
Vinyl Acetate		16U	11U	12U	11U	11U	11U
Bromodichloromethane		8U	6U	6U	6U	5U	6U
1,2-Dichloropropane		8U	6U	6U	6U	5U	6U
cis-1,3-Dichloropropene		8U	6U	6U	6U	5U	6U
Trichloroethene		8U	6U	6U	6U	5U	6U
Dibromochloromethane		8U	6U	6U	6U	5U	6U
1,1,2-Trichloroethane		8U	6U	6U	6U	5U	6U
Benzene		8U	6U	6U	6U	5U	6U
trans-1,3-Dichloropropene		8U	6U	6U	6U	5U	6U
Bromoform		8U	6U	6U	6U	5U	6U
4-Methyl-2-Pentanone		16U	11U	12U	11U	11U	11U
2-Hexanone		16U	11U	12U	11U	11U	11U
Tetrachloroethene		8U	6U	6U	6U	5U	6U
1,1,2,2-Tetrachloroethane		8U	6U	6U	6U	5U	6U
Toluene		8U	6U	6U	6U	5U	6U
Chlorobenzene		8U	6U	6U	6U	5U	6U
Ethylbenzene		8U	6U	6U	6U	5U	6U
Styrene		8U	6U	6U	6U	5U	6U
Total Xylenes		8U	6U	6U	6U	5U	6U

PROJECT Camp Lejeune
 PREPARED BY Ed King
 DATE 5/9/91
 CHECKED BY Judy Yuma
 DATE 5-15-91
 COMMENTS _____

CAMP LEJEL HPIA

VOLATILE ORGANIC COMPOUNDS IN SOIL SAMPLES

Concentration in ug/kg

CHART = SOIL-V11

COMPOUND	depth:	SB-21			SB-22			
		HPS021-1	HPS021-2	HPS021-3	HPS022-1	HPS022-1D (HPS0D-7)	HPS022-2	HPS022-3
		0-2'	2-4'	4-6'	0-2'	0-2'	2-4'	4-6'
Chloromethane		11U	11U	13U	11U	3J	11U	13U
Bromomethane		11U	11U	13U	11U	11U	11U	13U
Vinyl Chloride		11U	11U	13U	11U	11U	11U	13U
Chloroethane		11U	11U	13U	11U	11U	11U	13U
Methylene Chloride		2BJ	2BJ	2BJ	6U	6U	6U	6U
Acetone		5BJ	3BJ	17B	25	11J	26	31
Carbon Disulfide		6U	6U	6U	6U	6U	6U	6U
1,1-Dichloroethene		6U	6U	6U	6U	6U	6U	6U
1,1-Dichloroethane		6U	6U	6U	6U	6U	6U	6U
1,2-Dichloroethene (total)		6U	6U	6U	6U	6U	6U	6U
Chloroform		6U	6U	6U	6U	6U	6U	6U
1,2-Dichloroethane		6U	6U	6U	6U	6U	6U	6U
2-Butanone		11U	11U	13U	11U	11U	11U	13U
1,1,1-Trichloroethane		6U	6U	6U	6U	6U	6U	6U
Carbon Tetrachloride		6U	6U	6U	6U	6U	6U	6U
Vinyl Acetate		11U	11U	13U	11U	11U	11U	13U
Bromodichloromethane		6U	6U	6U	6U	6U	6U	6U
1,2-Dichloropropane		6U	6U	6U	6U	6U	6U	6U
cis-1,3-Dichloropropene		6U	6U	6U	6U	6U	6U	6U
Trichloroethene		6U	6U	6U	6U	6U	6U	6U
Dibromochloromethane		6U	6U	6U	6U	6U	6U	6U
1,1,2-Trichloroethane		6U	6U	6U	6U	6U	6U	6U
Benzene		6U	6U	6U	6U	6U	6U	6U
trans-1,3-Dichloropropene		6U	6U	6U	6U	6U	6U	6U
Bromoform		6U	6U	6U	6U	6U	6U	6U
4-Methyl-2-Pentanone		11U	11U	13U	11U	11U	11U	13U
2-Hexanone		11U	11U	13U	11U	11U	11U	13U
Tetrachloroethene		6U	6U	6U	6U	6U	6U	6U
1,1,2,2-Tetrachloroethane		6U	6U	6U	6U	6U	6U	6U
Toluene		6U	6U	6U	6U	6U	6U	6U
Chlorobenzene		6U	6U	6U	6U	6U	6U	6U
Ethylbenzene		6U	6U	6U	6U	6U	6U	6U
Styrene		6U	6U	6U	6U	6U	6U	6U
Total Xylenes		6U	6U	6U	6U	6U	6U	6U

CAMP LEJEL HPIA
VOLATILE ORGANIC COMPOUNDS IN SOIL SAMPLES
Concentration in ug/kg

CHART = SOIL-V12

COMPOUND	depth:	SB-23			SB-24			
		HPS023-1	HPS023-2	HPS023-3	HPS024-1	HPS024-1D (HPS0D-9)	HPS024-2	HPS024-3
		0-2'	2-4'	4-6'	0-2'	0-2'	4-6'	6-8'
Chloromethane		11U	12U	11U	11U	11U	11U	11U
Bromomethane		11U	12U	11U	11U	11U	11U	11U
Vinyl Chloride		11U	12U	11U	11U	11U	11U	11U
Chloroethane		11U	12U	11U	11U	11U	11U	11U
Methylene Chloride		2BJ	6U	5U	4BJ	1J	6U	6U
Acetone		11U	12U	5J	20	388	14	40
Carbon Disulfide		6U	6U	5U	5U	5U	6U	6U
1,1-Dichloroethene		6U	6U	5U	5U	5U	6U	6U
1,1-Dichloroethane		6U	6U	5U	5U	5U	6U	6U
1,2-Dichloroethene (total)		6U	6U	5U	5U	5U	6U	6U
Chloroform		6U	6U	5U	5U	5U	6U	6U
1,2-Dichloroethane		6U	6U	5U	5U	5U	6U	6U
2-Butanone		11U	12U	11U	11U	11U	11U	11U
1,1,1-Trichloroethane		6U	6U	5U	5U	5U	6U	6U
Carbon Tetrachloride		6U	6U	5U	5U	5U	6U	6U
Vinyl Acetate		11U	12U	11U	11U	11U	11U	11U
Bromodichloromethane		6U	6U	5U	5U	5U	6U	6U
1,2-Dichloropropane		6U	6U	5U	5U	5U	6U	6U
cis-1,3-Dichloropropene		6U	6U	5U	5U	5U	6U	6U
Trichloroethene		6U	6U	5U	5U	5U	6U	6U
Dibromochloromethane		6U	6U	5U	5U	5U	6U	6U
1,1,2-Trichloroethane		6U	6U	5U	5U	5U	6U	6U
Benzene		6U	6U	5U	5U	5U	6U	6U
trans-1,3-Dichloropropene		6U	6U	5U	5U	5U	6U	6U
Bromoform		6U	6U	5U	5U	5U	6U	6U
4-Methyl-2-Pentanone		11U	12U	11U	11U	11U	11U	11U
2-Hexanone		11U	12U	11U	11U	2J	11U	11U
Tetrachloroethene		6U	6U	5U	5U	5U	6U	6U
1,1,2,2-Tetrachloroethane		6U	6U	5U	5U	5U	6U	6U
Toluene		6U	6U	5U	5U	5U	6U	6U
Chlorobenzene		6U	6U	5U	5U	5U	6U	6U
Ethylbenzene		6U	6U	5U	5U	5U	6U	6U
Styrene		6U	6U	5U	5U	5U	6U	6U
Total Xylenes		6U	6U	5U	5U	5U	6U	6U

CAMP LEJEL HPIA
VOLATILE ORGANIC COMPOUNDS IN SOIL SAMPLES
Concentration in ug/kg

CHART = SOIL-V13

COMPOUND	depth:	SB-25			SB-26			
		HPS025-1	HPS025-2	HPS025-3	HPS026-1	HPS026-1D (HPS0D-8)	HPS026-2	HPS026-3
		0-2'	2-4'	6-8'	0-2'	0-2'	6-8'	8-10'
Chloromethane		11U	11U	11U	11U	11U	11U	11U
Bromomethane		11U	11U	11U	11U	11U	11U	11U
Vinyl Chloride		11U	11U	11U	11U	11U	11U	11U
Chloroethane		11U	11U	11U	11U	11U	11U	11U
Methylene Chloride		5U	5U	6U	3BJ	4BJ	4BJ	5BJ
Acetone		10J	12	8J	6J	11	9BJ	19
Carbon Disulfide		5U	5U	6U	5U	5U	6U	6U
1,1-Dichloroethene		5U	5U	6U	5U	5U	6U	6U
1,1-Dichloroethane		5U	5U	6U	5U	5U	6U	6U
1,2-Dichloroethene (total)		5U	5U	6U	5U	5U	6U	6U
Chloroform		5U	5U	6U	5U	5U	6U	6U
1,2-Dichloroethane		5U	5U	6U	5U	5U	6U	6U
2-Butanone		11U	11U	11U	11U	11U	11U	11U
1,1,1-Trichloroethane		5U	5U	6U	5U	5U	6U	6U
Carbon Tetrachloride		5U	5U	6U	5U	5U	6U	6U
Vinyl Acetate		11U	11U	11U	11U	11U	11U	11U
Bromodichloromethane		5U	5U	6U	5U	5U	6U	6U
1,2-Dichloropropane		5U	5U	6U	5U	5U	6U	6U
cis-1,3-Dichloropropene		5U	5U	6U	5U	5U	6U	6U
Trichloroethene		4J	5U	6U	2J	2J	6U	6U
Dibromochloromethane		5U	5U	6U	5U	5U	6U	6U
1,1,2-Trichloroethane		5U	5U	6U	5U	5U	6U	6U
Benzene		5U	5U	6U	5U	5U	6U	6U
trans-1,3-Dichloropropene		5U	5U	6U	5U	5U	6U	6U
Bromoform		5U	5U	6U	5U	5U	6U	6U
4-Methyl-2-Pentanone		11U	11U	11U	11U	11U	11U	11U
2-Hexanone		11U	11U	11U	11U	11U	11U	11U
Tetrachloroethene		5U	5U	6U	5U	5U	6U	6U
1,1,2,2-Tetrachloroethane		5U	5U	6U	5U	5U	6U	6U
Toluene		5U	5U	6U	5U	5U	6U	6U
Chlorobenzene		5U	5U	6U	5U	5U	6U	6U
Ethylbenzene		5U	5U	6U	5U	5U	6U	6U
Styrene		5U	5U	6U	5U	5U	6U	6U
Total Xylenes		5U	5U	6U	5U	5U	6U	6U

CAMP LE. HPIA
VOLATILE ORGANIC COMPOUNDS IN SOIL SAMPLES
Concentration in ug/kg

CHART = SOIL-V14

COMPOUND	depth:	SB-27			SB-28		
		HPSO27-1	HPSO27-2	HPSO27-3	HPSO28-1	HPSO28-2	HPSO28-3
		2-4'	4-6'	8-10'	0-2'	2-4'	8-10'
Chloromethane		11U	11U	12U	11U	11U	12U
Bromomethane		11U	11U	12U	11U	11U	12U
Vinyl Chloride		11U	11U	12U	11U	11U	12U
Chloroethane		11U	11U	12U	11U	11U	12U
Methylene Chloride		4BJ	15B	5BJ	5U	6U	6U
Acetone		11U	30B	50B	97	38J	88J
Carbon Disulfide		5U	5U	6U	5U	6U	6U
1,1-Dichloroethene		5U	5U	6U	5U	6U	6U
1,1-Dichloroethane		5U	5U	6U	5U	6U	6U
1,2-Dichloroethene (total)		5U	5U	6U	5U	6U	6U
Chloroform		5U	5U	6U	5U	6U	6U
1,2-Dichloroethane		5U	5U	6U	5U	6U	6U
2-Butanone		11U	11U	12U	11U	11U	12U
1,1,1-Trichloroethane		5U	5U	6U	5U	6U	6U
Carbon Tetrachloride		5U	5U	6U	5U	6U	6U
Vinyl Acetate		11U	11U	12U	11U	11U	12U
Bromodichloromethane		5U	5U	6U	5U	6U	6U
1,2-Dichloropropane		5U	5U	6U	5U	6U	6U
cis-1,3-Dichloropropene		5U	5U	6U	5U	6U	6U
Trichloroethene		5U	5U	6U	5U	6U	6U
Dibromochloromethane		5U	5U	6U	5U	6U	6U
1,1,2-Trichloroethane		5U	5U	6U	5U	6U	6U
Benzene		5U	5U	6U	5U	6U	6U
trans-1,3-Dichloropropene		5U	5U	6U	5U	6U	6U
Bromoform		5U	5U	6U	5U	6U	6U
4-Methyl-2-Pentanone		2J	11U	12U	11U	11U	12U
2-Hexanone		11U	11U	12U	11U	11U	12U
Tetrachloroethene		5U	5U	6U	5U	6U	6U
1,1,2,2-Tetrachloroethane		5U	5U	6U	5U	6U	6U
Toluene		5U	5U	6U	5U	6U	6U
Chlorobenzene		5U	5U	6U	5U	6U	6U
Ethylbenzene		5U	5U	6U	5U	6U	6U
Styrene		5U	5U	6U	5U	6U	6U
Total Xylenes		5U	5U	6U	5U	6U	6U

PROJECT Camp Lejeune
 PREPARED BY Ed Knight
 DATE 5/9/91
 CHECKED BY Judy Suma
 DATE 5-15-91
 COMMENTS _____

CAMP LEJEL. HPIA
VOLATILE ORGANIC COMPOUNDS IN SOIL SAMPLES
Concentration in ug/kg

CHART = SOIL-V15

COMPOUND	depth:	SB-29			SB-30		
		HPS029-1	HPS029-2	HPS029-3	HPS030-1	HPS030-2	HPS030-3
		0-2'	2-4'	10-12'	0-2'	2-4'	10-12'
Chloromethane		11U	11U	11U	11U	11U	12U
Bromomethane		11U	11U	11U	11U	11U	12U
Vinyl Chloride		11U	11U	11U	11U	11U	12U
Chloroethane		11U	11U	11U	11U	11U	12U
Methylene Chloride		14B	28J	8B	28J	28J	18J
Acetone		68J	78J	68J	68J	78J	78J
Carbon Disulfide		5U	5U	5U	6U	6U	6U
1,1-Dichloroethene		5U	5U	5U	6U	6U	6U
1,1-Dichloroethane		5U	5U	5U	6U	6U	6U
1,2-Dichloroethene (total)		5U	5U	5U	6U	6U	6U
Chloroform		5U	5U	5U	6U	6U	6U
1,2-Dichloroethane		5U	5U	5U	6U	6U	6U
2-Butanone		11U	11U	11U	11U	11U	12U
1,1,1-Trichloroethane		5U	5U	5U	6U	6U	6U
Carbon Tetrachloride		5U	5U	5U	6U	6U	6U
Vinyl Acetate		11U	11U	11U	11U	11U	12U
Bromodichloromethane		5U	5U	5U	6U	6U	6U
1,2-Dichloropropane		5U	5U	5U	6U	6U	6U
cis-1,3-Dichloropropene		5U	5U	5U	6U	6U	6U
Trichloroethene		5U	5U	5U	6U	6U	6U
Dibromochloromethane		5U	5U	5U	6U	6U	6U
1,1,2-Trichloroethane		5U	5U	5U	6U	6U	6U
Benzene		5U	5U	5U	6U	6U	6U
trans-1,3-Dichloropropene		5U	5U	5U	6U	6U	6U
Bromoform		5U	5U	5U	6U	6U	6U
4-Methyl-2-Pentanone		11U	11U	11U	11U	11U	12U
2-Hexanone		11U	11U	11U	11U	11U	12U
Tetrachloroethene		5U	5U	5U	6U	6U	6U
1,1,2,2-Tetrachloroethane		5U	5U	5U	6U	6U	6U
Toluene		5U	5U	5U	6U	6U	6U
Chlorobenzene		5U	5U	5U	6U	6U	6U
Ethylbenzene		5U	5U	5U	6U	6U	6U
Styrene		5U	5U	5U	6U	6U	6U
Total Xylenes		5U	5U	5U	6U	6U	6U

CAMP LEJEUNE - HPIA
SEMI-VOLATILE ORGANIC COMPOUNDS IN SOIL SAMPLES
Concentration in ug/kg

CHART = SOIL-S1A

COMPOUND	depth:	SB-1		SB-6	SB-10
		HPS01-1 0-2'	HPS01-1D (HPS0D-1) 0-2'	HPS06-1 0-2'	HPS010-1 0-2'
Phenol		370U	370U	350U	380U
bis(2-Chloroethyl)ether		370U	370U	350U	380U
2-Chlorophenol		370U	370U	350U	380U
1,3-Dichlorobenzene		370U	370U	350U	380U
1,4-Dichlorobenzene		370U	370U	350U	380U
Benzyl Alcohol		370U	370U	350U	380U
1,2-Dichlorobenzene		370U	370U	350U	380U
2-Methylphenol		370U	370U	350U	380U
bis(2-Chloroisopropyl)ether		370U	370U	350U	380U
4-Methylphenol		370U	370U	350U	380U
N-Nitroso-di-n-propylamine		370U	370U	350U	380U
Hexachloroethane		370U	370U	350U	380U
Nitrobenzene		370U	370U	350U	380U
Isophorone		370U	370U	350U	380U
2-Nitrophenol		370U	370U	350U	380U
2,4-Dimethylphenol		370U	370U	350U	380U
Benzoic acid		1800U	1800U	1700U	1900U
bis(2-Chloroethoxy)methane		370U	370U	350U	380U
2,4-Dichlorophenol		370U	370U	350U	380U
1,2,4-Trichlorobenzene		370U	370U	350U	380U
Naphthalene		370U	370U	350U	380U
4-Chloroaniline		370U	370U	350U	380U
Hexachlorobutadiene		370U	370U	350U	380U
4-Chloro-3-methylphenol		370U	370U	350U	380U
2-Methylnaphthalene		370U	370U	350U	380U
Hexachlorocyclopentadiene		370U	370U	350U	380U
2,4,6-Trichlorophenol		370U	370U	350U	380U
2,4,5-Trichlorophenol		1800U	1800U	1700U	1900U
2-Chloronaphthalene		370U	370U	350U	380U
2-Nitroaniline		1800U	1800U	1700U	1900U
Dimethylphthalate		370U	370U	350U	380U
Acenaphthylene		370U	370U	350U	380U
2,6-Dinitrotoluene		370U	370U	350U	380U

PROJECT Camp Lejeune
PREPARED BY Judy Luma
DATE May 1991
CHECKED BY Ed Knight
DATE 5/21/91

COMMENTS

CAMP LL - HPIA
SEMI-VOLATILE ORGANIC COMPOUNDS IN SOIL SAMPLES
Concentration in ug/kg

CHART=SOIL-S1B

COMPOUND	depth:	SB-1		SB-6	SB-10
		HPS01-1 0-2'	HPS01-1D (HPS0D-1) 0-2'	HPS06-1 0-2'	HPS010-1 0-2'
3-Nitroaniline		1800U	1800U	1700U	1900U
Acenaphthene		370U	370U	42J	380U
2,4-Dinitrophenol		1800U	1800U	1700U	1900U
4-Nitrophenol		1800U	1800U	1700U	1900U
Dibenzofuran		370U	370U	350U	380U
2,4-Dinitrotoluene		370U	370U	350U	380U
Diethylphthalate		370U	370U	350U	380U
4-Chlorophenyl-phenylether		370U	370U	350U	380U
Fluorene		370U	370U	48J	380U
4-Nitroaniline		1800U	1800U	1700U	1900U
4,6-Dinitro-2-methylphenol		1800U	1800U	1700U	1900U
N-Nitrosodiphenylamine (1)		370U	370U	350U	380U
4-Bromophenyl-phenylether		370U	370U	350U	380U
Hexachlorobenzene		370U	370U	350U	380U
Pentachlorophenol		1800U	1800U	1700U	1900U
Phenanthrene		94J	290J	500	380U
Anthracene		370U	67J	180J	380U
Di-n-butylphthalate		370U	370U	350U	380U
Fluoranthene		100J	360J	690	380U
Pyrene		94J	320J	530	380U
Butylbenzylphthalate		370U	370U	350U	380U
3,3'-Dichlorobenzidine		740U	730U	710U	770U
Benzo(a)anthracene		41J	100J	280J	380U
Chrysene		44J	110J	260J	380U
bis(2-Ethylhexyl)phthalate		370U	370U	16J	380U
Di-n-octylphthalate		370U	370U	350U	380U
Benzo(b)fluoranthene		39J	59J	250J	380U
Benzo(k)fluoranthene		48JX	82JX	210J	380U
Benzo(a)pyrene		370U	65J	240J	380U
Indeno(1,2,3-cd)pyrene		370U	37J	130J	380U
Dibenz(a,h)anthracene		370U	370U	350U	380U
Benzo(g,h,i)perylene		370U	370U	110J	380U

(1) Cannot be separated from Diphenylamine

CAMP LEJEUNE - HPIA
SEMI-VOLATILE ORGANIC COMPOUNDS IN SOIL SAMPLES
Concentration in ug/kg

CHART = SOIL-S2A

COMPOUND	depth:	SB-11	SB-15	SB-20
		HPS011-1	HPS015-1	HPS020-1
		0-2'	0-2'	0-2'
Phenol		350U	370U	370U
bis(2-Chloroethyl)ether		350U	370U	370U
2-Chlorophenol		350U	370U	370U
1,3-Dichlorobenzene		350U	370U	370U
1,4-Dichlorobenzene		350U	48J	47J
Benzyl Alcohol		350U	370U	370U
1,2-Dichlorobenzene		350U	370U	370U
2-Methylphenol		350U	370U	370U
bis(2-Chloroisopropyl)ether		350U	370U	370U
4-Methylphenol		350U	370U	370U
N-Nitroso-di-n-propylamine		350U	370U	370U
Hexachloroethane		350U	370U	370U
Nitrobenzene		350U	370U	370U
Isophorone		350U	370U	370U
2-Nitrophenol		350U	370U	370U
2,4-Dimethylphenol		350U	370U	370U
Benzoic acid		1700U	1800U	1800U
bis(2-Chloroethoxy)methane		350U	370U	370U
2,4-Dichlorophenol		350U	370U	370U
1,2,4-Trichlorobenzene		350U	370U	370U
Naphthalene		350U	370U	370U
4-Chloroaniline		350U	370U	370U
Hexachlorobutadiene		350U	370U	370U
4-Chloro-3-methylphenol		350U	370U	370U
2-Methylnaphthalene		350U	370U	370U
Hexachlorocyclopentadiene		350U	370U	370U
2,4,6-Trichlorophenol		350U	370U	370U
2,4,5-Trichlorophenol		1700U	1800U	1800U
2-Chloronaphthalene		350U	370U	370U
2-Nitroaniline		1700U	1800U	1800U
Dimethylphthalate		350U	370U	370U
Acenaphthylene		350U	370U	370U
2,6-Dinitrotoluene		350U	370U	370U

PROJECT Camp Lejeune
 PREPARED BY Judy Guana
 DATE May 1991
 CHECKED BY E. L. Knyff
 DATE 5/21/91

CAMP LE. - HPIA

SEMI-VOLATILE ORGANIC COMPOUNDS IN SOIL SAMPLES

Concentration in ug/kg

CHART=SOIL-S2B

COMPOUND	depth:	SB-11	SB-15	SB-20
		HPSO11-1	HPSO15-1	HPSO20-1
		0-2'	0-2'	0-2'
3-Nitroaniline		1700U	1800U	1800U
Acenaphthene		72J	370U	370U
2,4-Dinitrophenol		1700U	1800U	1800U
4-Nitrophenol		1700U	1800U	1800U
Dibenzofuran		72J	370U	370U
2,4-Dinitrotoluene		350U	370U	370U
Diethylphthalate		350U	370U	370U
4-Chlorophenyl-phenylether		350U	370U	370U
Fluorene		63J	370U	370U
4-Nitroaniline		1700U	1800U	1800U
4,6-Dinitro-2-methylphenol		1700U	1800U	1800U
N-Nitrosodiphenylamine (1)		350U	370U	370U
4-Bromophenyl-phenylether		350U	370U	370U
Hexachlorobenzene		350U	370U	370U
Pentachlorophenol		1700U	1800U	1800U
Phenanthrene		210J	210J	370U
Anthracene		350U	43J	370U
Di-n-butylphthalate		350U	72J	370U
Fluoranthene		200J	370J	370U
Pyrene		120J	290J	370U
Butylbenzylphthalate		350U	370U	370U
3,3'-Dichlorobenzidine		690U	740U	740U
Benzo(a)anthracene		70J	140J	370U
Chrysene		95J	170J	370U
bis(2-Ethylhexyl)phthalate		350U	54J	370U
Di-n-octylphthalate		350U	370U	370U
Benzo(b)fluoranthene		120J	140J	370U
Benzo(k)fluoranthene		79J	150JX	370U
Benzo(a)pyrene		64J	140J	370U
Indeno(1,2,3-cd)pyrene		37J	82J	370U
Dibenz(a,h)anthracene		350U	370U	370U
Benzo(g,h,i)perylene		350U	72J	370U

(1) Cannot be separated from Diphenylamine

CAMP LEJEUNE - HPIA
SEMI-VOLATILE ORGANIC COMPOUNDS IN SOIL SAMPLES
Concentration in ug/kg

CHART = SOIL-S3A

COMPOUND	depth:	SB-21	SB-30
		HPS021-1	HPS030-1
		0-2'	0-2'
Phenol		370U	370U
bis(2-Chloroethyl)ether		370U	370U
2-Chlorophenol		370U	370U
1,3-Dichlorobenzene		370U	370U
1,4-Dichlorobenzene		370U	370U
Benzyl Alcohol		370U	370U
1,2-Dichlorobenzene		370U	370U
2-Methylphenol		370U	370U
bis(2-Chloroisopropyl)ether		370U	370U
4-Methylphenol		370U	370U
N-Nitroso-di-n-propylamine		370U	370U
Hexachloroethane		370U	370U
Nitrobenzene		370U	370U
Isophorone		370U	370U
2-Nitrophenol		370U	370U
2,4-Dimethylphenol		370U	370U
Benzoic acid		1800U	1800U
bis(2-Chloroethoxy)methane		370U	370U
2,4-Dichlorophenol		370U	370U
1,2,4-Trichlorobenzene		370U	370U
Naphthalene		370U	220J
4-Chloroaniline		370U	370U
Hexachlorobutadiene		370U	370U
4-Chloro-3-methylphenol		370U	370U
2-Methylnaphthalene		370U	300J
Hexachlorocyclopentadiene		370U	370U
2,4,6-Trichlorophenol		370U	370U
2,4,5-Trichlorophenol		1800U	1800U
2-Chloronaphthalene		370U	370U
2-Nitroaniline		1800U	1800U
Dimethylphthalate		370U	370U
Acenaphthylene		370U	370U
2,6-Dinitrotoluene		370U	370U

PROJECT Camp Lejeune
 PREPARED BY Julie Huma
 DATE May 1991
 CHECKED BY Ed Kryzsd
 DATE 5/21/91
 COMMENTS _____

CAMP LE. - HPIA
SEMI-VOLATILE ORGANIC COMPOUNDS IN SOIL SAMPLES
Concentration in ug/kg

CHART=SOIL-S3B

COMPOUND	depth:	SB-21	SB-30
		HPS021-1	HPS030-1
		0-2'	0-2'
3-Nitroaniline		1800U	1800U
Acenaphthene		370U	370U
2,4-Dinitrophenol		1800U	1800U
4-Nitrophenol		1800U	1800U
Dibenzofuran		370U	51J
2,4-Dinitrotoluene		370U	370U
Diethylphthalate		370U	370U
4-Chlorophenyl-phenylether		370U	370U
Fluorene		370U	370U
4-Nitroaniline		1800U	1800U
4,6-Dinitro-2-methylphenol		1800U	1800U
N-Nitrosodiphenylamine (1)		370U	370U
4-Bromophenyl-phenylether		370U	370U
Hexachlorobenzene		370U	370U
Pentachlorophenol		1800U	1800U
Phenanthrene		370U	110J
Anthracene		370U	370U
Di-n-butylphthalate		370U	370U
Fluoranthene		370U	370U
Pyrene		370U	370U
Butylbenzylphthalate		370U	370U
3,3'-Dichlorobenzidine		730U	740U
Benzo(a)anthracene		370U	370U
Chrysene		370U	370U
bis(2-Ethylhexyl)phthalate		370U	370U
Di-n-octylphthalate		370U	370U
Benzo(b)fluoranthene		370U	370U
Benzo(k)fluoranthene		370U	370U
Benzo(a)pyrene		370U	370U
Indeno(1,2,3-cd)pyrene		370U	370U
Dibenz(a,h)anthracene		370U	370U
Benzo(g,h,i)perylene		370U	370U

(1) Cannot be separated from Diphenylamine

CAMP LEJEUNE - HPIA
 INORGANICS IN SOIL SAMPLES
 Concentration in mg/kg

CHART = SOIL-11

METAL/COMPOUND	depth:	SB-1		SB-6	SB-10
		HPS01-1 0-2'	HPS01-1D (HPS0D-1) 0-2'	HPS06-1 0-2'	HPS010-1 0-2'
Aluminum		3590.00	4140.00	3400.00	3920.00
Antimony		5.40UN	5.90BN	7.40BN	9.60BN
Arsenic		0.55B	0.50B	0.66B	0.57B
Barium		6.00B	6.10B	6.00B	19.60B
Beryllium		0.20U	0.16U	0.17U	0.19U
Cadmium		0.80B	0.47U	1.70	0.94
Calcium		1450.00	1660.00	4410.00	1830.00
Chromium		5.00	5.00	4.10	11.80
Cobalt		1.40B	0.93B	1.40B	1.70B
Copper		1.40B	1.10B	1.00B	4.90
Iron		1790.00E	2030.00E	1790.00E	2020.00E
Lead		2.40N*	3.70N*S	3.20N*	56.90N*S
Magnesium		128.00B	116.00B	134.00B	121.00B
Manganese		3.80	2.50	2.90	7.70
Mercury		0.11U	0.09U	0.10U	0.09U
Nickel		2.60B	1.70B	1.70B	2.80B
Potassium		124.00B	127.00B	113.00B	155.00B
Selenium		0.16U	0.21BW	0.39BW	0.45B
Silver		0.80U	0.62U	0.69U	1.10B
Sodium		120.00B	297.00B	92.20B	121.00B
Thallium		0.16UW	0.17UW	0.18UW	0.19UW
Vanadium		5.20B	6.10B	4.60B	5.30B
Zinc		0.80B	1.40B	1.20B	32.30
Cyanide		0.69U	0.69U	0.70U	0.70U

PROJECT	Camp Lejeune
PREPARED BY	Guilly Yuma
DATE	May 1991
CHECKED BY	E. L. Knight
DATE	5/16/91
COMMENTS	

CAMP LEJEUNE - HPIA
 INORGANICS IN SOIL SAMPLES
 Concentration in mg/kg

CHART = SOIL-12

METAL/COMPOUND	depth:	SB-11	SB-15	SB-20
		HPS011-1	HPS015-1	HPS020-1
		0-2'	0-2'	0-2'
Aluminum		1740.00	2180.00	4.10U
Antimony		6.50BN	5.40BN	5.70BN
Arsenic		0.38U	1.40B	0.43U
Barium		13.20B	13.20B	0.39U
Beryllium		0.20U	0.17U	0.20U
Cadmium		3.00	1.20	0.59U
Calcium		19700.00	62700.00	19.60U
Chromium		8.30	9.40	0.59B
Cobalt		2.60B	1.60B	1.20B
Copper		2.00B	8.90	0.39B
Iron		5090.00E	2050.00E	1.80UE
Lead		3.60N*S	84.80N*S	2.30N*
Magnesium		1100.00	1210.00	26.70U
Manganese		155.00	16.00	0.20U
Mercury		0.09U	0.11U	0.09U
Nickel		2.80B	2.40B	2.20B
Potassium		1190.00	125.00B	167.00B
Selenium		0.19U	0.21B	0.21U
Silver		0.79U	0.70U	0.98B
Sodium		242.00B	206.00B	68.00B
Thallium		0.19U	0.18UW	0.21U
Vanadium		2.60B	5.90B	0.59U
Zinc		19.10	61.20	2.50B
Cyanide		0.31U	0.79U	0.70U

PROJECT Camp Lejeune

PREPARED BY Johny Suma

DATE May 1991

CHECKED BY Ed Knyfel

DATE 5/16/91

REMARKS _____

CAMP LEJEUNE - HPIA
INORGANICS IN SOIL SAMPLES
Concentration in mg/kg

CHART = SOIL-13

METAL/COMPOUND	depth: 0-2'	
	SB-21 HPS021-1	SB-30 HPS030-1
Aluminum	5620.00	3710.00
Antimony	7.508N	6.308N
Arsenic	0.53B	0.34U
Barium	11.00B	12.40B
Beryllium	0.17U	0.16U
Cadmium	1.00	1.30
Calcium	7480.00	3360.00
Chromium	7.20	8.90
Cobalt	1.00U	1.10B
Copper	3.30B	11.80
Iron	2840.00E	4320.00E
Lead	36.60N**	5.40N*
Magnesium	295.00B	163.00B
Manganese	5.70	37.90
Mercury	0.11U	0.11U
Nickel	2.60B	5.80B
Potassium	145.00B	134.00B
Selenium	0.15U	0.24B
Silver	0.69U	0.65U
Sodium	103.00B	122.00B
Thallium	0.15U	0.17UW
Vanadium	7.40B	4.80B
Zinc	8.70	8.60
Cyanide	0.73U	0.70U

PROJECT Camp Lejeune
 PREPARED BY Quincy Keuma
 DATE May 7, 1991
 CHECKED BY Ed King
 DATE 5/16/91
 COMMENTS _____

CAMP LEJEUNE - HPIA
 TCLP METALS IN SOIL SAMPLES
 Concentration in ug/l

CHART = SOIL-T1

TCLP METALS	depth:	SB-1		SB-2			SB-3	
		HPS01-2	HPS01-3	HPS02-1	HPS02-2	HPS02-2D (HPS0D-2)	HPS03-1	HPS03-1D (HPS0D-3)
		2-4'	4-6'	0-2'	2-4'	2-4'	0-2'	0-2'
Arsenic		112.00B	785.00B	100.00B	75.00B	112.00B	75.00B	92.00B
Barium		334.00	201.00	153.00B	255.00	584.00	382.00	244.00
Cadmium		5.00B	3.00U	6.00B	4.00B	3.00B	27.00	15.00
Chromium		5.00B	6.00B	5.00B	3.00B	6.00B	5.00B	4.00B
Lead		56.00B	56.00B	41.00B	69.00B	54.00B	79.00B	47.00B
Mercury		0.20U	0.20U	0.20U	0.20U	0.20U	0.20U	0.20U
Selenium		121.00BN	530.00BN	65.00BN	110.00BN	63.00UN	76.00BN	100.00BN
Silver		4.00U	4.00U	4.00U	4.00U	4.00U	4.00U	4.00U

PROJECT Camp Lejeune
 PREPARED BY Eel Knysel
 DATE 5/91
 CHECKED BY Paul Suma
 DATE 5-21-91

CAMP LEJEUNE - HP1A
 TCLP METALS IN SOIL SAMPLES
 Concentration in ug/l

CHART = SOIL-T2

TCLP METALS	depth:	SB-4				SB-5		
		HPS04-1	HPS04-2	HPS04-2D (HPS0D-4)	HPS04-3	HPS05-1	HPS05-2	HPS05-3
		0-2'	2-4'	2-4'	4-6'	0-2'	2-4'	4-6'
Arsenic		161.00B	111.00B	101.00B	95.00B	86.00B	122.00B	120.00B
Barium		306.00	188.00B	166.00B	240.00	210.00	277.00	231.00
Cadmium		10.00	3.00B	3.00B	3.00U	3.00B	3.00U	3.00U
Chromium		7.00B	5.00B	4.00B	4.00B	5.00B	6.00B	4.00B
Lead		57.00B	53.00B	50.00B	70.00B	65.00B	53.00B	48.00B
Mercury		0.20U	0.20U	0.20U	0.20U	0.20U	0.20U	0.20U
Selenium		75.00BN	89.00BN	168.00BN	130.00BN	63.00UN	63.00UN	113.00BN
Silver		4.00U	4.00U	4.00U	4.00U	4.00U	4.00U	4.00U

PROJECT Camp Lejeune
 PREPARED BY EO Knapp
 DATE 5/91
 CHECKED BY Judy Suma
 DATE 5-22-91

CAMP LEJEUNE - HPIA
 TCLP METALS IN SOIL SAMPLES
 Concentration in ug/l

CHART = SOIL-T3

TCLP METALS	depth:	SB-6		SB-7		
		HPS06-2	HPS06-3	HPS07-1	HPS07-2	HPS07-3
		2-4'	4-6'	0-2'	2-4'	4-6'
Arsenic		128.00B	40.00U	90.00B	48.00B	109.00B
Barium		191.00B	207.00	191.00B	158.00B	186.00B
Cadmium		3.00B	7.00B	8.00B	3.00U	9.00B
Chromium		3.00B	5.00B	3.00B	3.00B	4.00B
Lead		47.00B	45.00B	44.00B	45.00B	44.00B
Mercury		0.20U	0.20U	0.20U	0.20U	0.20U
Selenium		63.00UN	63.00UN	147.00BN	75.00BN	63.00UN
Silver		4.00U	5.00B	4.00U	4.00U	4.00U

PROJECT Camp Lejeune
 PREPARED BY Ed Kryzel
 DATE 5/91
 CHECKED BY Judy Yuma
 DATE 5-20-91

CAMP LEJEUNE - HPTA
 TCLP METALS IN SOIL SAMPLES
 Concentration in ug/L

CHART = SOIL-T4

TCLP METALS	SB-8			SB-9			SB-10	
	HPS08-1	HPS08-2	HPS08-3	HPS09-1	HPS09-2	HPS09-3	HPS010-2	HPS010-3
	depth: 0-2'	2-4'	4-6'	0-2'	2-4'	4-6'	2-4'	4-6'
Arsenic	78.00B	40.00U	54.00B	58.00B	62.00B	58.00B	90.00B	49.00B
Barium	257.00	218.00E	164.00BE	542.00E	182.00BE	185.00BE	173.00BE	149.00BE
Cadmium	4.00B	3.00B	3.00B	12.00	3.00U	3.00B	3.00U	3.00U
Chromium	3.00B	4.00B	3.00U	5.00B	4.00B	4.00B	5.00B	3.00B
Lead	42.00B	27.00U	39.00B	57.00B	47.00B	30.00B	45.00B	63.00B
Mercury	0.20U	0.20U	0.20U	0.20U	0.20U	0.20U	0.20U	0.20U
Selenium	100.00BN	102.00B	73.00B	68.00B	67.00B	94.00B	70.00B	75.00B
Silver	4.00U	4.00U	4.00U	4.00U	4.00U	4.00U	4.00U	4.00U

PROJECT Camp Lejeune
 PREPARED BY Ed Krystal
 DATE 5/91
 CHECKED BY Judy Yundt
 DATE 5-21-91

CAMP LEJEUNE - HPIA
 TCLP METALS IN SOIL SAMPLES
 Concentration in ug/l

CHART = SOIL-T5

TCLP METALS	SB-11			SB-12		
	HPS011-2 depth: 2-4'	HPS011-3 4-6'	HPS011-3D (HPS0D-5) 4-6'	HPS012-1 0-2'	HPS012-2 2-4'	HPS012-3 8-10'
Arsenic	55.00B	81.00B	63.00B	47.00B*	50.00B*	64.00B*
Barium	268.00E	199.00BE	299.00E	210.00E	206.00E	181.00BE
Cadmium	4.00B	4.00B	3.00U	3.00U	3.00U	3.00U
Chromium	3.00B	7.00B	6.00B	9.00B	9.00B	10.00B
Lead	70.00B	45.00B	30.00B	48.00B	34.00B	27.00B
Mercury	0.20U	0.20U	1.00	0.20U	0.20U	0.20U
Selenium	63.00U	63.00U	63.00U	102.00B	66.00B	87.00B
Silver	4.00U	4.00U	4.00U	4.00U	4.00U	4.00U

PROJECT Camp Lejeune
 PREPARED BY Judy Guma
 DATE May 1991
 CHECKED BY Ed Kuyf
 DATE 5/21/91
 COMMENTS _____

CAMP LEJEUNE - HPIA
 TCLP METALS IN SOIL SAMPLES
 Concentration in ug/l

CHART = SOIL-T6

TCLP METALS	SB-13			SB-14			SB-15	
	HPS013-1	HPS013-2	HPS013-3	HPS014-1	HPS014-2	HPS014-3	HPS015-2	HPS015-3
	0-2'	6-8'	8-10'	2-4'	4-6'	8-10'	6-8'	8-10'
Arsenic	70.00B	64.00B	62.00B	49.00B	62.00B	40.00U	59.00B	72.00B
Barium	213.00	162.00B	356.00	183.00B	213.00	246.00	178.00BE	128.00BE
Cadmium	3.00B	3.00B	3.00B	5.00B	3.00B	6.00B	3.00B	5.00B
Chromium	3.00B	9.00B	7.00B	6.00B	7.00B	4.00B	6.00B	4.00B
Lead	27.00U	27.00U	27.00U	40.00B	46.00B	27.00U	48.00B	41.00B
Mercury	0.20U	0.20U	0.20U	0.20U	0.20U	0.20U	0.20U	0.20U
Selenium	74.00B	63.00U	63.00U	63.00U	83.00B	69.00B	82.00B	65.00B
Silver	4.00U	4.00B	4.00U	4.00U	4.00U	4.00U	4.00U	4.00U

PROJECT Camp Lejeune
 PREPARED BY ED Knapp
 DATE 5/91
 CHECKED BY Judy Summa
5-20-91

CAMP LEJEUNE - HPIA
 TCLP METALS IN SOIL SAMPLES
 Concentration in ug/l

CHART = SOIL-T7

		SB-16			SB-17			
		HPS016-1	HPS016-2	HPS016-3	HPS017-1	HPS017-1D (HPS0D-6)	HPS017-2	HPS017-3
TCLP METALS	depth:	0-2'	6-8'	8-10'	0-2'	0-2'	6-8'	8-10'
Arsenic		70.00B	51.00B	61.00B	117.00B	102.00B	66.00B	58.00B
Barium		148.00B	179.00B	161.00B	331.00	363.00	165.00B	167.00B
Cadmium		5.00B	3.00U	3.00U	4.00B	6.00B	4.00B	5.00B
Chromium		4.00B	6.00B	6.00B	7.00B	6.00B	6.00B	6.00B
Lead		32.00B	27.00U	31.00B	57.00B	80.00B	27.00U	31.00B
Mercury		0.20U	0.20U	0.20U	0.20U	0.20U	0.20U	0.20U
Selenium		70.00B	82.00B	63.00U	63.00U	84.00B	81.00B	63.00U
Silver		4.00U	4.00U	4.00B	4.00U	4.00B	4.00U	4.00U

PROJECT Camp Lejeune
 PREPARED BY Judy Guma
 DATE May 1991
 CHECKED BY Ed Kryfel
 DATE 5/21/91
 COMMENTS _____

CAMP LEJEUNE - HPIA
 TCLP METALS IN SOIL SAMPLES
 Concentration in ug/l

CHART = SOIL-T8

TCLP METALS	depth:	SB-18			SB-19			SB-20	
		HPS018-1	HPS018-2	HPS018-3	HPS019-1	HPS019-2	HPS019-3	HPS020-2	HPS020-3
		4-6'	6-8'	8-10'	0-2'	2-4'	8-10'	6-8'	8-10'
Arsenic		79.00B	81.00B	100.00B	80.00B	90.00B	75.00B	40.00U	40.00U
Barium		174.00B	152.00B	163.00B	245.00	178.00B	179.00B	110.00BE	121.00BE
Cadmium		5.00B	4.00B	4.00B	3.00B	3.00B	5.00B	3.00U	3.00B
Chromium		6.00B	5.00B	5.00B	6.00B	10.00B	3.00B	4.00B	3.00B
Lead		27.00U	45.00B	34.00B	47.00B	41.00B	34.00B	27.00U	27.00U
Mercury		0.20U	0.20U	0.20U	0.20U	0.20U	0.20U	0.20U	0.20U
Selenium		87.00B	74.00B	63.00U	63.00U	114.00B	63.00U	63.00U	63.00U
Silver		4.00U	4.00U	4.00U	5.00B	4.00U	4.00U	4.00U	4.00U

PROJECT Camp Lejeune
 PREPARED BY Judy Guma
 DATE May 1991
 CHECKED BY Ed Krystol
 DATE 5/21/91
 COMMENTS _____

CAMP LEJEUNE - HPIA
 TCLP METALS IN SOIL SAMPLES
 Concentration in ug/l

CHART = SOIL-T9

TCLP METALS	SB-21		SB-22			
	HPS021-2 depth: 2-4	HPS021-3 4-6'	HPS022-1 0-2'	HPS022-1D (HPS0D-7) 0-2'	HPS022-2 2-4'	HPS022-3 4-6'
Arsenic	51.00B	74.00B	58.00B	111.00B	137.00B	40.00U
Barium	110.00BE	140.00BE	320.00NE	247.00NE	298.00NE	335.00NE
Cadmium	4.00B	3.00B	3.00U	3.00U	3.00U	3.00U
Chromium	3.00U	4.00B	4.00B	3.00U	6.00B	4.00B
Lead	42.00B	50.00B	45.00B	46.00B	49.00B	49.00B
Mercury	0.20U	0.70B	0.20U	0.20U	0.20U	0.20U
Selenium	63.00U	86.00B	63.00U	63.00U	63.00U	63.00U
Silver	4.00U	4.00U	4.00U	4.00U	4.00U	4.00U

PROJECT Camp Lejeune
 PREPARED BY Ed Kuybal
 DATE 5/91
 CHECKED BY Judy Gump
 DATE 5-21-91

CAMP LEJEUNE - HPIA
 TCLP METALS IN SOIL SAMPLES
 Concentration in ug/l

CHART = SOIL-T10

TCLP METALS	depth:	SB-23			SB-24			
		HPSO23-1	HPSO23-2	HPSO23-3	HPSO24-1	HPSO24-1D (HPSO24-9)	HPSO24-2	HPSO24-3
		0-2'	2-4'	4-6'	0-2'	0-2'	4-6'	6-8'
Arsenic		160.00B*	142.00B*	73.00B*	92.00B*	554.00*	40.00U	42.00B
Barium		297.00E	236.00E	146.00BE	137.00BE	136.00BE	232.00NE	223.00NE
Cadmium		16.00	3.00B	4.00B	3.00B	3.00B	3.00B	3.00B
Chromium		13.00B	10.00B	8.00B	10.00B	7.00B	5.00B	4.00B
Lead		207.00	76.00B	33.00B	27.00U	37.00B	34.00B	55.00B
Mercury		0.20U	0.20U	0.20U	0.20U	0.20U	0.20U	0.20U
Selenium		106.00B	79.00B	133.00B	100.00B	96.00B	63.00U	63.00U
Silver		4.00U	4.00U	4.00U	4.00U	4.00U	4.00U	4.00U

PROJECT Camp Lejeune
 PREPARED BY Judy Guma
 DATE May 1991
 CHECKED BY EQ Knysel
 DATE 5/21/91

CAMP LEJEUNE - HPIA
 TCLP METALS IN SOIL SAMPLES
 Concentration in ug/l

CHART = SOIL-T11

TCLP METALS	SB-25			SB-26			
	HPS025-1 depth: 0-2'	HPS025-2 2-4'	HPS025-3 6-8'	HPS026-1 0-2'	HPS026-1D (HPS0D-8) 0-2'	HPS026-2 6-8'	HPS026-3 8-10'
Arsenic	40.00U*	85.00B*	114.00B*	40.00U	56.00B	68.00B	80.00B
Barium	162.00BE	187.00BE	200.00E	596.00NE	609.00NE	176.00BNE	201.00NE
Cadmium	3.00U	3.00U	3.00U	3.00U	3.00U	3.00U	3.00B
Chromium	8.00B	9.00B	10.00B	5.00B	3.00B	6.00B	4.00B
Lead	39.00B	27.00B	29.00B	38.00B	47.00B	28.00B	57.00B
Mercury	0.20U	0.20U	0.20U	0.20U	0.20U	0.20U	0.20U
Selenium	67.00B	63.00U	141.00B	63.00U	63.00U	63.00U	63.00U
Silver	4.00U	4.00U	4.00U	4.00U	4.00U	4.00U	4.00U

PROJECT Camp Lejeune
 PREPARED BY Ed Kryszel
 DATE 5/91
 CHECKED BY John Yuma
5-21-91

CAMP LEJEUNE - HPIA
 TCLP METALS IN SOIL SAMPLES
 Concentration in ug/l

CHART = SOIL-T12

TCLP METALS	depth:	SB-27			SB-28		
		HPS027-1	HPS027-2	HPS027-3	HPS028-1	HPS028-2	HPS028-3
		2-4'	4-6'	8-10'	0-2'	2-4'	8-10'
Arsenic		50.00B*	90.00B*	46.00B*	64.00B*	40.00U*	102.00B*
Barium		174.00BE	143.00BE	196.00BE	146.00BE	184.00BE	165.00BE
Cadmium		3.00U	3.00U	3.00U	3.00U	3.00U	5.00B
Chromium		9.00B	10.00B	8.00B	11.00B	8.00B	9.00B
Lead		27.00U	55.00B	59.00B	39.00B	33.00B	55.00B
Mercury		0.20U	0.20U	0.20U	0.20U	0.20U	0.20U
Selenium		116.00B	109.00B	123.00B	115.00B	147.00B	119.00B
Silver		4.00U	4.00U	4.00U	4.00U	4.00U	4.00U

PROJECT Camp Lejeune
 PREPARED BY Ed Krupel
 DATE 5/91
 CHECKED BY Judy Yuma
 DATE 50.22-91

CAMP LEJEUNE - HPIA
VOLATILE ORGANIC COMPOUNDS IN GROUNDWATER (DEEP WELLS)
Concentration in ug/l

CHART = HPVOL7

wp8b\hp-vol.wr1 (7)

COMPOUND	HPGW4-3	HPGW9-3	HPGW9-3D (GWDUP3)	HPGW24-3	HPGW30-3	HPGW31-3	HPGW32-3
Chloromethane	10.U	10.U	10.U	10.U	10.U	10.U	10.U
Bromomethane	10.U	10.U	10.U	10.U	10.U	10.U	10.U
Vinyl Chloride	10.U	10.U	10.U	10.U	10.U	10.U	10.U
Chloroethane	10.U	10.U	10.U	10.U	10.U	10.U	10.U
Methylene Chloride	2.J	5.U	5.U	.8BJ	5.U	5.U	1.BJ
Acetone	4.J	10.U	10.U	10.U	10.U	27.B	13.
Carbon Disulfide	4.J	5.U	5.U	5.U	5.U	6.	5.U
1,1-Dichloroethene	5.U	5.U	5.U	5.U	5.U	5.U	5.U
1,1-Dichloroethane	5.U	5.U	5.U	5.U	5.U	5.U	5.U
1,2-Dichloroethene (total)	5.U	5.U	5.U	5.U	5.U	5.U	5.U
Chloroform	5.U	5.U	5.U	5.U	5.U	5.U	5.U
1,2-Dichloroethane	5.U	5.U	5.U	5.U	5.U	5.U	5.U
2-Butanone	10.U	5.J	10.U	10.U	10.U	10.U	10.U
1,1,1-Trichloroethane	5.U	5.U	5.U	5.U	5.U	5.U	5.U
Carbon Tetrachloride	5.U	5.U	5.U	5.U	5.U	5.U	5.U
Vinyl Acetate	10.U	10.U	10.U	10.U	10.U	10.U	10.U
Bromodichloromethane	5.U	5.U	5.U	5.U	5.U	5.U	5.U
1,2-Dichloropropane	5.U	5.U	5.U	5.U	5.U	5.U	5.U
cis-1,3-Dichloropropene	5.U	5.U	5.U	5.U	5.U	5.U	5.U
Trichloroethene	5.U	5.U	5.U	5.U	5.U	5.U	5.U
Dibromochloromethane	5.U	5.U	5.U	5.U	5.U	5.U	5.U
1,1,2-Trichloroethane	5.U	5.U	5.U	5.U	5.U	5.U	5.U
Benzene	5.U	5.U	5.U	5.U	5.U	5.U	5.U
trans-1,3-Dichloropropene	5.U	5.U	5.U	5.U	5.U	5.U	5.U
Bromoform	5.U	5.U	5.U	5.U	5.U	5.U	5.U
4-Methyl-2-Pentanone	10.U	10.U	10.U	10.U	10.U	10.U	10.U
2-Hexanone	10.U	10.U	10.U	10.U	10.U	10.U	10.U
Tetrachloroethene	5.U	5.U	.6J	5.U	5.U	5.U	5.U
1,1,2,2-Tetrachloroethane	5.U	5.U	5.U	5.U	5.U	5.U	5.U
Toluene	5.U	5.U	5.U	5.U	5.U	5.U	34.
Chlorobenzene	5.U	5.U	5.U	5.U	5.U	5.U	5.U
Ethylbenzene	5.U	5.U	5.U	5.U	5.U	5.U	12.
Styrene	5.U	5.U	5.U	5.U	5.U	5.U	5.U
Xylene (total)	5.U	5.U	5.U	5.U	5.U	5.U	51.

PROJECT	Camp Lejeune
PREPARED BY	Paul M. Rumberg
DATE	April 1991
CHECKED BY	Judy Luna
DATE	5-17-91
COMMENTS	

CAMP LEJEUNE - HPIA
 TCLP METALS IN SOIL SAMPLES
 Concentration in ug/l

CHART = SOIL-T13

		SB-29			SB-30	
		HPS029-1	HPS029-2	HPS029-3	HPS030-2	HPS030-3
TCLP METALS	depth:	0-2'	2-4'	10-12'	2-4'	10-12'
Arsenic		48.00B	40.00U	40.00U	49.00B	40.00U
Barium		549.00NE	400.00NE	200.00NE	135.00BE	130.00BE
Cadmium		3.00U	3.00U	3.00U	3.00U	4.00B
Chromium		3.00B	4.00B	4.00B	3.00U	6.00B
Lead		40.00B	42.00B	60.00B	43.00B	27.00B
Mercury		0.20U	0.20U	0.20U	0.20U	0.20U
Selenium		63.00U	63.00U	63.00U	63.00U	107.00B
Silver		4.00U	4.00U	4.00U	4.00U	4.00U

PROJECT Camp Lejeune
 PREPARED BY Judy Guena
 DATE May 1991
 CHECKED BY Ed Knight
 DATE 5/21/91
 COMMENTS _____

CAMP LEJEUNE - HPIA
PESTICIDES IN SOIL SAMPLES
Concentration in ug/kg

CHART = SOIL-P1

		SB-1				SB-2		
PESTICIDE/PCB	depth:	HPS01-1	HPS01-1D (HPS00-1)	HPS01-2	HPS01-3	HPS02-1	HPS02-2	HPS02-2D (HPS00-2)
		0-2'	0-2'	2-4'	4-6'	0-2'	2-4'	2-4'
alpha-BHC		9.0U	8.9U	9.2U	9.2U	8.9U	9.3U	9.5U
beta-BHC		9.0U	8.9U	9.2U	9.2U	8.9U	9.3U	9.5U
delta-BHC		9.0U	8.9U	9.2U	9.2U	8.9U	9.3U	9.5U
gamma-BHC (Lindane)		9.0U	8.9U	9.2U	9.2U	8.9U	9.3U	9.5U
Heptachlor		9.0U	8.9U	9.2U	9.2U	8.9U	9.3U	9.5U
Aldrin		9.0U	8.9U	9.2U	9.2U	8.9U	9.3U	9.5U
Heptachlor epoxide		9.0U	8.9U	9.2U	9.2U	8.9U	9.3U	9.5U
Endosulfan I		9.0U	8.9U	9.2U	9.2U	8.9U	9.3U	9.5U
Dieldrin		18U	18U	18U	18U	18U	19U	19U
4,4'-DDE		18U	18U	18U	18U	18U	19U	19U
Endrin		18U	18U	18U	18U	18U	19U	19U
Endosulfan II		18U	18U	18U	18U	18U	19U	19U
4,4'-DDD		18U	18U	18U	18U	18U	19U	19U
Endosulfan sulfate		18U	18U	18U	18U	18U	19U	19U
4,4'-DDT		18U	18U	18U	18U	18U	19U	19U
Methoxychlor		90U	89U	92U	92U	89U	93U	95U
Endrin ketone		18U	18U	18U	18U	18U	19U	19U
alpha-Chlordane		90U	89U	92U	92U	89U	93U	95U
gamma-Chlordane		90U	89U	92U	92U	89U	93U	95U
Toxaphene		180U	180U	180U	180U	180U	190U	190U
Aroclor-1016		90U	89U	92U	92U	89U	93U	95U
Aroclor-1221		90U	89U	92U	92U	89U	93U	95U
Aroclor-1232		90U	89U	92U	92U	89U	93U	95U
Aroclor-1242		90U	89U	92U	92U	89U	93U	95U
Aroclor-1248		90U	89U	92U	92U	89U	93U	95U
Aroclor-1254		180U	180U	180U	180U	180U	190U	190U
Aroclor-1260		180U	180U	180U	180U	180U	190U	190U

CAMP LEJEUNE-HP1A
 PESTICIDES IN SOIL SAMPLES
 Concentration in ug/kg

CHART = SOIL-P2

PESTICIDE/PCB	depth:	SB-3		SB-4			
		HPS03-1	HPS03-1D (HPS0D-3)	HPS04-1	HPS04-2	HPS04-2D (HPS0D-4)	HPS04-3
		0-2'	0-2'	0-2'	2-4'	2-4'	4-6'
alpha-BHC		8.9U	9.0U	8.9U	9.0U	9.3U	9.4U
beta-BHC		8.9U	9.0U	8.9U	9.0U	9.3U	9.4U
delta-BHC		8.9U	9.0U	8.9U	9.0U	9.3U	9.4U
gamma-BHC (Lindane)		8.9U	9.0U	8.9U	9.0U	9.3U	9.4U
Heptachlor		8.9U	9.0U	8.9U	9.0U	9.3U	9.4U
Aldrin		8.9U	9.0U	8.9U	9.0U	9.3U	9.4U
Heptachlor epoxide		8.9U	9.0U	8.9U	9.0U	9.3U	9.4U
Endosulfan I		8.9U	9.0U	8.9U	9.0U	9.3U	9.4U
Dieldrin		18U	18U	18U	18U	19U	19U
4,4'-DDE		18U	18U	18U	18U	19U	19U
Endrin		18U	18U	18U	18U	19U	19U
Endosulfan II		18U	18U	18U	18U	19U	19U
4,4'-DDD		18U	18U	18U	18U	19U	19U
Endosulfan sulfate		18U	18U	18U	18U	19U	19U
4,4'-DDT		18U	18U	18U	18U	19U	19U
Methoxychlor		89U	90U	89U	90U	93U	94U
Endrin ketone		18U	18U	18U	18U	19U	19U
alpha-Chlordane		89U	90U	89U	90U	93U	94U
gamma-Chlordane		89U	90U	89U	90U	93U	94U
Toxaphene		180U	180U	180U	180U	190U	190U
Aroclor-1016		89U	90U	89U	90U	93U	94U
Aroclor-1221		89U	90U	89U	90U	93U	94U
Aroclor-1232		89U	90U	89U	90U	93U	94U
Aroclor-1242		89U	90U	89U	90U	93U	94U
Aroclor-1248		89U	90U	89U	90U	93U	94U
Aroclor-1254		180U	180U	180U	180U	190U	190U
Aroclor-1260		180U	180U	180U	180U	190U	190U

CAMP LEJEUNE - HPIA
 PESTICIDES IN SOIL SAMPLES
 Concentration in ug/kg

CHART = SOIL-P3

sy\wp8d\base-

PESTICIDE/PCB	depth:	SB-5			SB-6		
		HPS05-1	HPS05-2	HPS05-3	HPS06-1	HPS06-2	HPS06-3
		0-2'	2-4'	4-6'	0-2'	2-4'	4-6'
alpha-BHC		9.0U	9.3U	9.4U	9.0U	9.0U	9.5U
beta-BHC		9.0U	9.3U	9.4U	9.0U	9.0U	9.5U
delta-BHC		9.0U	9.3U	9.4U	9.0U	9.0U	9.5U
gamma-BHC (Lindane)		9.0U	9.3U	9.4U	9.0U	9.0U	9.5U
Heptachlor		9.0U	9.3U	9.4U	9.0U	9.0U	9.5U
Aldrin		9.0U	9.3U	9.4U	9.0U	9.0U	9.5U
Heptachlor epoxide		9.0U	9.3U	9.4U	9.0U	9.0U	9.5U
Endosulfan I		9.0U	9.3U	9.4U	9.0U	9.0U	9.5U
Dieldrin		18U	19U	19U	18U	18U	19U
4,4'-DDE		18U	19U	19U	18U	18U	19U
Endrin		18U	19U	19U	18U	18U	19U
Endosulfan II		18U	19U	19U	18U	18U	19U
4,4'-DDD		18U	19U	19U	18U	18U	19U
Endosulfan sulfate		18U	19U	19U	18U	18U	19U
4,4'-DDT		18U	19U	19U	18U	18U	19U
Methoxychlor		90U	93U	94U	90U	90U	95U
Endrin ketone		18U	19U	19U	18U	18U	19U
alpha-Chlordane		90U	93U	94U	90U	90U	95U
gamma-Chlordane		90U	93U	94U	90U	90U	95U
Toxaphene		180U	190U	190U	180U	180U	190U
Aroclor-1016		90U	93U	94U	90U	90U	95U
Aroclor-1221		90U	93U	94U	90U	90U	95U
Aroclor-1232		90U	93U	94U	90U	90U	95U
Aroclor-1242		90U	93U	94U	90U	90U	95U
Aroclor-1248		90U	93U	94U	90U	90U	95U
Aroclor-1254		180U	190U	190U	180U	180U	190U
Aroclor-1260		180U	190U	190U	180U	180U	190U

Camp Lejeune
 5/9/91
 J. J. ...
 DATE 5-17-91
 COMMENTS

CAMP LEJEUNE - HPIA
 PESTICIDES IN SOIL SAMPLES
 Concentration in ug/kg

CHART = SOIL-P4

sy\wp8d\base-

PESTICIDE/PCB	depth:	SB-7			SB-8		
		HPS07-1	HPS07-2	HPS07-3	HPS08-1	HPS08-2	HPS08-3
		0-2'	2-4'	4-6'	0-2'	2-4'	4-6'
alpha-BHC		9.0U	9.0U	10U	9.4U	9.1U	9.5U
beta-BHC		9.0U	9.0U	10U	9.4U	9.1U	9.5U
delta-BHC		9.0U	9.0U	10U	9.4U	9.1U	9.5U
gamma-BHC (Lindane)		9.0U	9.0U	10U	9.4U	9.1U	9.5U
Heptachlor		9.0U	9.0U	10U	9.4U	9.1U	9.5U
Aldrin		9.0U	9.0U	10U	9.4U	9.1U	9.5U
Heptachlor epoxide		9.0U	9.0U	10U	9.4U	9.1U	9.5U
Endosulfan I		9.0U	9.0U	10U	9.4U	9.1U	9.5U
Dieldrin		18U	18U	20U	19U	18U	19U
4,4'-DDE		18U	18U	20U	19U	18U	19U
Endrin		18U	18U	20U	19U	18U	19U
Endosulfan II		18U	18U	20U	19U	18U	19U
4,4'-DDD		18U	18U	20U	19U	18U	19U
Endosulfan sulfate		18U	18U	20U	19U	18U	19U
4,4'-DDT		18U	18U	20U	19U	18U	19U
Methoxychlor		90U	90U	100U	94U	91U	95U
Endrin ketone		18U	18U	20U	19U	18U	19U
alpha-Chlordane		90U	90U	100U	94U	91U	95U
gamma-Chlordane		90U	90U	100U	94U	91U	95U
Toxaphene		180U	180U	200U	190U	180U	190U
Aroclor-1016		90U	90U	100U	94U	91U	95U
Aroclor-1221		90U	90U	100U	94U	91U	95U
Aroclor-1232		90U	90U	100U	94U	91U	95U
Aroclor-1242		90U	90U	100U	94U	91U	95U
Aroclor-1248		90U	90U	100U	94U	91U	95U
Aroclor-1254		180U	180U	200U	190U	180U	190U
Aroclor-1260		180U	180U	200U	190U	180U	190U

PROJECT Camp Lejeune
 PREPARED BY E.C. King
 DATE 5/91
 DATE July 5-17-91
 COMMENTS _____

CAMP LEJEUNE - HPIA
 PESTICIDES IN SOIL SAMPLES
 Concentration in ug/kg

CHART = SOIL-P5

PESTICIDE/PCB	depth:	SB-9			SB-10		
		HPS09-1	HPS09-2	HPS09-3	HPS010-1	HPS010-2	HPS010-3
		0-2'	2-4'	4-6'	0-2'	2-4'	4-6'
alpha-BHC		9.1U	9.0U	9.2U	9.2U	9.3U	9.4U
beta-BHC		9.1U	9.0U	9.2U	9.2U	9.3U	9.4U
delta-BHC		9.1U	9.0U	9.2U	9.2U	9.3U	9.4U
gamma-BHC (Lindane)		9.1U	9.0U	9.2U	9.2U	9.3U	9.4U
Heptachlor		9.1U	9.0U	9.2U	9.2U	9.3U	9.4U
Aldrin		9.1U	9.0U	9.2U	9.2U	9.3U	9.4U
Heptachlor epoxide		9.1U	9.0U	9.2U	9.2U	9.3U	9.4U
Endosulfan I		9.1U	9.0U	9.2U	9.2U	9.3U	9.4U
Dieldrin		18U	18U	18U	18U	19U	19U
4,4'-DDE		18U	18U	18U	18U	19U	19U
Endrin		18U	18U	18U	18U	19U	19U
Endosulfan II		18U	18U	18U	18U	19U	19U
4,4'-DDD		18U	18U	18U	18U	19U	19U
Endosulfan sulfate		18U	18U	18U	18U	19U	19U
4,4'-DDT		18U	18U	18U	18U	19U	19U
Methoxychlor		91U	90U	92U	92U	93U	94U
Endrin ketone		18U	18U	18U	18U	19U	19U
alpha-Chlordane		91U	90U	92U	92U	93U	94U
gamma-Chlordane		91U	90U	92U	92U	93U	94U
Toxaphene		180U	180U	180U	180U	190U	190U
Aroclor-1016		91U	90U	92U	92U	93U	94U
Aroclor-1221		91U	90U	92U	92U	93U	94U
Aroclor-1232		91U	90U	92U	92U	93U	94U
Aroclor-1242		91U	90U	92U	92U	93U	94U
Aroclor-1248		91U	90U	92U	92U	93U	94U
Aroclor-1254		180U	180U	180U	180U	190U	190U
Aroclor-1260		180U	180U	180U	180U	190U	190U

CAMP LEJEUNE - HPIA
PESTICIDES IN SOIL SAMPLES
Concentration in ug/kg

CHART = SOIL-P6

		SB-11				SB-12		
PESTICIDE/PCB	depth:	HPS011-1	HPS011-2	HPS011-3	HPS011-3D (HPS0D-5)	HPS012-1	HPS012-2	HPS012-3
		0-2'	2-4'	4-6'	4-6'	0-2'	2-4'	8-10'
alpha-BHC		8.4U	9.0U	9.3U	9.4U	8.9U	8.9U	9.3U
beta-BHC		8.4U	9.0U	9.3U	9.4U	8.9U	8.9U	9.3U
delta-BHC		8.4U	9.0U	9.3U	9.4U	8.9U	8.9U	9.3U
gamma-BHC (Lindane)		8.4U	9.0U	9.3U	9.4U	8.9U	8.9U	9.3U
Heptachlor		8.4U	9.0U	9.3U	9.4U	8.9U	8.9U	9.3U
Aldrin		8.4U	9.0U	9.3U	9.4U	8.9U	8.9U	9.3U
Heptachlor epoxide		8.4U	12	9.3U	9.4U	8.9U	8.9U	9.3U
Endosulfan I		8.4U	16	9.3U	9.4U	8.9U	8.9U	9.3U
Dieldrin		17U	18U	19U	19U	18U	18U	19U
4,4'-DDE		17U	18U	19U	19U	18U	18U	19U
Endrin		17U	18U	19U	19U	18U	18U	19U
Endosulfan II		17U	18U	19U	19U	18U	18U	19U
4,4'-DDD		17U	18U	19U	19U	18U	18U	19U
Endosulfan sulfate		17U	18U	19U	19U	18U	18U	19U
4,4'-DDT		17U	22	19U	19U	18U	18U	19U
Methoxychlor		84U	90U	93U	94U	89U	89U	93U
Endrin ketone		17U	18U	19U	19U	18U	18U	19U
alpha-Chlordane		84U	90U	93U	94U	89U	89U	93U
gamma-Chlordane		84U	90U	93U	94U	89U	89U	93U
Toxaphene		170U	180U	190U	190U	180U	180U	190U
Aroclor-1016		84U	90U	93U	94U	89U	89U	93U
Aroclor-1221		84U	90U	93U	94U	89U	89U	93U
Aroclor-1232		84U	90U	93U	94U	89U	89U	93U
Aroclor-1242		84U	90U	93U	94U	89U	89U	93U
Aroclor-1248		84U	90U	93U	94U	89U	89U	93U
Aroclor-1254		170U	180U	190U	190U	180U	180U	190U
Aroclor-1260		290	1800	1000	670	180U	180U	190U

CAMP LEJEUNE - HPIA
PESTICIDES IN SOIL SAMPLES
Concentration in ug/kg

CHART = SOIL-P7

PESTICIDE/PCB	depth:	SB-13			SB-14		
		HPS013-1	HPS013-2	HPS013-3	HPS014-1	HPS014-2	HPS014-3
		0-2'	6-8'	8-10'	2-4'	4-6'	8-10'
alpha-BHC		9.1U	8.5U	9.3U	9.0U	8.9U	9.4U
beta-BHC		9.1U	8.5U	9.3U	9.0U	8.9U	9.4U
delta-BHC		9.1U	8.5U	9.3U	9.0U	8.9U	9.4U
gamma-BHC (Lindane)		9.1U	8.5U	9.3U	9.0U	8.9U	9.4U
Heptachlor		9.1U	8.5U	9.3U	9.0U	8.9U	9.4U
Aldrin		9.1U	8.5U	9.3U	9.0U	8.9U	9.4U
Heptachlor epoxide		9.1U	8.5U	9.3U	9.0U	8.9U	9.4U
Endosulfan I		9.1U	8.5U	9.3U	9.0U	8.9U	9.4U
Dieldrin		18U	17U	19U	18U	18U	19U
4,4'-DDE		18U	17U	19U	18U	18U	19U
Endrin		18U	17U	19U	18U	18U	19U
Endosulfan II		18U	17U	19U	18U	18U	19U
4,4'-DDD		18U	17U	19U	18U	18U	19U
Endosulfan sulfate		18U	17U	19U	18U	18U	19U
4,4'-DDT		18U	17U	19U	18U	18U	19U
Methoxychlor		91U	85U	93U	90U	89U	94U
Endrin ketone		18U	17U	19U	18U	18U	19U
alpha-Chlordane		91U	85U	93U	90U	89U	94U
gamma-Chlordane		91U	85U	93U	90U	89U	94U
Toxaphene		180U	170U	190U	180U	180U	190U
Aroclor-1016		91U	85U	93U	90U	89U	94U
Aroclor-1221		91U	85U	93U	90U	89U	94U
Aroclor-1232		91U	85U	93U	90U	89U	94U
Aroclor-1242		91U	85U	93U	90U	89U	94U
Aroclor-1248		91U	85U	93U	90U	89U	94U
Aroclor-1254		180U	170U	190U	180U	180U	190U
Aroclor-1260		180U	170U	190U	180U	180U	190U

CAMP LEJUNO - HPIA
 PESTICIDES IN SOIL SAMPLES
 Concentration in ug/kg

CHART = SOIL-P8

PESTICIDE/PCB	depth:	SB-15			SB-16		
		HPS015-1	HPS015-2	HPS015-3	HPS016-1	HPS016-2	HPS016-3
		0-2'	6-8'	8-10'	0-2'	6-8'	8-10'
alpha-BHC		8.8U	8.9U	9.0U	8.9U	8.8U	9.7U
beta-BHC		8.8U	8.9U	9.0U	8.9U	8.8U	9.7U
delta-BHC		8.8U	8.9U	9.0U	8.9U	8.8U	9.7U
gamma-BHC (Lindane)		8.8U	8.9U	9.0U	8.9U	8.8U	9.7U
Heptachlor		8.8U	8.9U	9.0U	8.9U	8.8U	9.7U
Aldrin		8.8U	8.9U	9.0U	8.9U	8.8U	9.7U
Heptachlor epoxide		8.8U	8.9U	9.0U	8.9U	8.8U	9.7U
Endosulfan I		8.8U	8.9U	9.0U	8.9U	8.8U	9.7U
Dieldrin		38	18U	18U	18U	18U	19U
4,4'-DDE		97	18U	18U	18U	18U	19U
Endrin		18U	18U	18U	18U	18U	19U
Endosulfan II		18U	18U	18U	18U	18U	19U
4,4'-DDD		18U	18U	18U	18U	18U	19U
Endosulfan sulfate		18U	18U	18U	18U	18U	19U
4,4'-DDT		140	18U	18U	18U	18U	19U
Methoxychlor		88U	89U	90U	89U	88U	97U
Endrin ketone		18U	18U	18U	18U	18U	19U
alpha-Chlordane		88U	89U	90U	89U	88U	97U
gamma-Chlordane		88U	89U	90U	89U	88U	97U
Toxaphene		180U	180U	180U	180U	180U	190U
Aroclor-1016		88U	89U	90U	89U	88U	97U
Aroclor-1221		88U	89U	90U	89U	88U	97U
Aroclor-1232		88U	89U	90U	89U	88U	97U
Aroclor-1242		88U	89U	90U	89U	88U	97U
Aroclor-1248		88U	89U	90U	89U	88U	97U
Aroclor-1254		180U	180U	180U	180U	180U	190U
Aroclor-1260		180U	180U	180U	180U	180U	190U

PROJECT Camp Lejuno
 PREPARED BY Judy Guma
 DATE May 1991
 CHECKED BY Ed King
 DATE 5/20/91
 COMMENTS _____

CAMP LEJEUNE - HPIA
 PESTICIDES IN SOIL SAMPLES
 Concentration in ug/kg

CHART = SOIL-P9

PESTICIDE/PCB	depth:	SB-17				SB-18		
		HPS017-1	HPS017-1D (HPS0D-6)	HPS017-2	HPS017-3	HPS018-1	HPS018-2	HPS018-3
		0-2'	0-2'	6-8'	8-10'	4-6'	6-8'	8-10'
alpha-BHC		8.9U	8.8U	8.8U	9.5U	9.1U	8.9U	9.0U
beta-BHC		8.9U	8.8U	8.8U	9.5U	9.1U	8.9U	9.0U
delta-BHC		8.9U	8.8U	8.8U	9.5U	9.1U	8.9U	9.0U
gamma-BHC (Lindane)		8.9U	8.8U	8.8U	9.5U	9.1U	8.9U	9.0U
Heptachlor		8.9U	8.8U	8.8U	9.5U	9.1U	8.9U	9.0U
Aldrin		8.9U	8.8U	8.8U	9.5U	9.1U	8.9U	9.0U
Heptachlor epoxide		8.9U	8.8U	8.8U	9.5U	9.1U	8.9U	9.0U
Endosulfan I		8.9U	8.8U	8.8U	9.5U	9.1U	8.9U	9.0U
Dieldrin		18U	18U	18U	19U	18U	18U	18U
4,4'-DDE		18U	18U	18U	19U	18U	18U	18U
Endrin		18U	18U	18U	19U	18U	18U	18U
Endosulfan II		18U	18U	18U	19U	18U	18U	18U
4,4'-DDD		18U	18U	18U	19U	18U	18U	18U
Endosulfan sulfate		18U	18U	18U	19U	18U	18U	18U
4,4'-DDT		18U	18U	18U	19U	18U	18U	18U
Methoxychlor		89U	88U	88U	95U	91U	89U	90U
Endrin ketone		18U	18U	18U	19U	18U	18U	18U
alpha-Chlordane		89U	88U	88U	95U	91U	89U	90U
gamma-Chlordane		89U	88U	88U	95U	91U	89U	90U
Toxaphene		180U	180U	180U	190U	180U	180U	180U
Aroclor-1016		89U	88U	88U	95U	91U	89U	90U
Aroclor-1221		89U	88U	88U	95U	91U	89U	90U
Aroclor-1232		89U	88U	88U	95U	91U	89U	90U
Aroclor-1242		89U	88U	88U	95U	91U	89U	90U
Aroclor-1248		89U	88U	88U	95U	91U	89U	90U
Aroclor-1254		780	580	180U	190U	180U	180U	180U
Aroclor-1260		180U	180U	180U	190U	180U	180U	180U

CAMP LEJEUNE - HPIA
PESTICIDES IN SOIL SAMPLES
Concentration in ug/kg

CHART = SOIL-P10

PESTICIDE/PCB	depth:	SB-19			SB-20		
		HPS019-1	HPS019-2	HPS019-3	HPS020-1	HPS020-2	HPS020-3
		0-2'	2-4'	8-10'	0-2'	6-8'	8-10'
alpha-BHC		13U	8.9U	9.5U	8.9U	8.4U	9.0U
beta-BHC		13U	8.9U	9.5U	8.9U	8.4U	9.0U
delta-BHC		13U	8.9U	9.5U	8.9U	8.4U	9.0U
gamma-BHC (Lindane)		13U	8.9U	9.5U	8.9U	8.4U	9.0U
Heptachlor		13U	8.9U	9.5U	8.9U	8.4U	9.0U
Aldrin		13U	8.9U	9.5U	8.9U	8.4U	9.0U
Heptachlor epoxide		13U	8.9U	9.5U	8.9U	8.4U	9.0U
Endosulfan I		13U	8.9U	9.5U	8.9U	8.4U	9.0U
Dieldrin		26U	18U	19U	18U	17U	18U
4,4'-DDE		26U	18U	19U	18U	17U	18U
Endrin		26U	18U	19U	18U	17U	18U
Endosulfan II		26U	18U	19U	18U	17U	18U
4,4'-DDD		26U	18U	19U	18U	17U	18U
Endosulfan sulfate		26U	18U	19U	18U	17U	18U
4,4'-DDT		26U	18U	19U	18U	17U	18U
Methoxychlor		130U	89U	95U	89U	84U	90U
Endrin ketone		26U	18U	19U	18U	17U	18U
alpha-Chlordane		130U	89U	95U	89U	84U	90U
gamma-Chlordane		130U	89U	95U	89U	84U	90U
Toxaphene		260U	180U	190U	180U	170U	180U
Aroclor-1016		130U	89U	95U	89U	84U	90U
Aroclor-1221		130U	89U	95U	89U	84U	90U
Aroclor-1232		130U	89U	95U	89U	84U	90U
Aroclor-1242		130U	89U	95U	89U	84U	90U
Aroclor-1248		130U	89U	95U	89U	84U	90U
Aroclor-1254		260U	180U	190U	180U	170U	180U
Aroclor-1260		260U	180U	190U	180U	170U	180U

CAMP LEJEUNE - HPIA
PESTICIDES IN SOIL SAMPLES
Concentration in ug/kg

CHART = SOIL-P11

PESTICIDE/PCB	depth:	SB-21			SB-22			
		HPSO21-1	HPSO21-2	HPSO21-3	HPSO22-1	HPSO22-1D (HPSO2-7)	HPSO22-2	HPSO22-3
		0-2'	2-4'	4-6'	0-2'	0-2'	2-4'	4-6'
alpha-BHC		8.9U	9.2U	10U	9.2U	9.2U	9.0U	10U
beta-BHC		8.9U	9.2U	10U	9.2U	9.2U	9.0U	10U
delta-BHC		8.9U	9.2U	10U	9.2U	9.2U	9.0U	10U
gamma-BHC (Lindane)		8.9U	9.2U	10U	9.2U	9.2U	9.0U	10U
Heptachlor		8.9U	9.2U	10U	9.2U	9.2U	9.0U	10U
Aldrin		8.9U	9.2U	10U	9.2U	9.2U	9.0U	10U
Heptachlor epoxide		8.9U	9.2U	10U	9.2U	9.2U	9.0U	10U
Endosulfan I		8.9U	9.2U	10U	9.2U	9.2U	9.0U	10U
Dieldrin		18U	18U	20U	18U	18U	18U	21U
4,4'-DDE		18U	18U	20U	18U	18U	18U	21U
Endrin		18U	18U	20U	18U	18U	18U	21U
Endosulfan II		18U	18U	20U	18U	18U	18U	21U
4,4'-DDD		18U	18U	20U	18U	18U	18U	21U
Endosulfan sulfate		18U	18U	20U	18U	18U	18U	21U
4,4'-DDT		18U	18U	20U	18U	18U	18U	21U
Methoxychlor		89U	92U	100U	92U	92U	90U	100U
Endrin ketone		18U	18U	20U	18U	18U	18U	21U
alpha-Chlordane		89U	92U	100U	92U	92U	90U	100U
gamma-Chlordane		89U	92U	100U	92U	92U	90U	100U
Toxaphene		180U	180U	200U	180U	180U	180U	210U
Aroclor-1016		89U	92U	100U	92U	92U	90U	100U
Aroclor-1221		89U	92U	100U	92U	92U	90U	100U
Aroclor-1232		89U	92U	100U	92U	92U	90U	100U
Aroclor-1242		89U	92U	100U	92U	92U	90U	100U
Aroclor-1248		89U	92U	100U	92U	92U	90U	100U
Aroclor-1254		180U	180U	200U	180U	180U	180U	210U
Aroclor-1260		180U	180U	200U	180U	180U	180U	210U

CAMP LEJEUNE - HPIA
 PESTICIDES IN SOIL SAMPLES
 Concentration in ug/kg

CHART = SOIL-P12

PESTICIDE/PCB	depth:	SB-23			SB-24			
		HPSO23-1	HPSO23-2	HPSO23-3	HPSO24-1	HPSO24-1D (HPSO24-9)	HPSO24-2	HPSO24-3
		0-2'	2-4'	4-6'	0-2'	0-2'	4-6'	6-8'
alpha-BHC		8.9U	9.2U	8.7U	8.6U	8.4U	8.9U	9.1U
beta-BHC		8.9U	9.2U	8.7U	8.6U	8.4U	8.9U	9.1U
delta-BHC		8.9U	9.2U	8.7U	8.6U	8.4U	8.9U	9.1U
gamma-BHC (Lindane)		8.9U	9.2U	8.7U	8.6U	8.4U	8.9U	9.1U
Heptachlor		8.9U	9.2U	8.7U	8.6U	8.4U	8.9U	9.1U
Aldrin		8.9U	9.2U	8.7U	8.6U	8.4U	8.9U	9.1U
Heptachlor epoxide		8.9U	9.2U	8.7U	8.6U	8.4U	8.9U	9.1U
Endosulfan I		8.9U	9.2U	8.7U	8.6U	8.4U	8.9U	9.1U
Dieldrin		92	18U	17U	17U	17U	18U	18U
4,4'-DDE		78	18U	17U	17U	17U	18U	18U
Endrin		18U	18U	17U	17U	17U	18U	18U
Endosulfan II		18U	18U	17U	17U	17U	18U	18U
4,4'-DDD		18U	18U	17U	17U	17U	18U	18U
Endosulfan sulfate		18U	18U	17U	17U	17U	18U	18U
4,4'-DDT		40	18U	17U	17U	17U	18U	18U
Methoxychlor		89U	92U	87U	86U	84U	89U	91U
Endrin ketone		18U	18U	17U	17U	17U	18U	18U
alpha-Chlordane		89U	92U	87U	86U	84U	89U	91U
gamma-Chlordane		89U	92U	87U	86U	84U	89U	91U
Toxaphene		180U	180U	170U	170U	170U	180U	180U
Aroclor-1016		89U	92U	87U	86U	84U	89U	91U
Aroclor-1221		89U	92U	87U	86U	84U	89U	91U
Aroclor-1232		89U	92U	87U	86U	84U	89U	91U
Aroclor-1242		89U	92U	87U	86U	84U	89U	91U
Aroclor-1248		89U	92U	87U	86U	84U	89U	91U
Aroclor-1254		180U	180U	170U	170U	170U	180U	180U
Aroclor-1260		180U	180U	170U	170U	170U	180U	180U

CAMP LEJEUNE - HPIA
 PESTICIDES IN SOIL SAMPLES
 Concentration in ug/kg

CHART = SOIL-P13

PESTICIDE/PCB	depth:	SB-25			SB-26			
		HPS025-1	HPS025-2	HPS025-3	HPS026-1	HPS026-1D (HPS0D-8)	HPS026-2	HPS026-3
		0-2'	2-4'	6-8'	0-2'	0-2'	6-8'	8-10'
alpha-BHC		8.4U	8.5U	8.9U	8.4U	8.4U	9.2U	9.0U
beta-BHC		8.4U	8.5U	8.9U	8.4U	8.4U	9.2U	9.0U
delta-BHC		8.4U	8.5U	8.9U	8.4U	8.4U	9.2U	9.0U
gamma-BHC (Lindane)		8.4U	8.5U	8.9U	8.4U	8.4U	9.2U	9.0U
Heptachlor		8.4U	8.5U	8.9U	8.4U	8.4U	9.2U	9.0U
Aldrin		8.4U	8.5U	8.9U	8.4U	8.4U	9.2U	9.0U
Heptachlor epoxide		8.4U	8.5U	8.9U	8.4U	8.4U	9.2U	9.0U
Endosulfan I		8.4U	8.5U	8.9U	8.4U	8.4U	9.2U	9.0U
Dieldrin		17U	17U	18U	17U	17U	18U	18U
4,4'-DDE		17U	17U	18U	17U	17U	18U	18U
Endrin		17U	17U	18U	17U	17U	18U	18U
Endosulfan II		17U	17U	18U	17U	17U	18U	18U
4,4'-DDD		17U	17U	18U	17U	17U	18U	18U
Endosulfan sulfate		17U	17U	18U	17U	17U	18U	18U
4,4'-DDT		17U	17U	18U	17U	17U	18U	18U
Methoxychlor		84U	85U	89U	84U	84U	92U	90U
Endrin ketone		17U	17U	18U	17U	17U	18U	18U
alpha-Chlordane		84U	85U	89U	84U	84U	92U	90U
gamma-Chlordane		84U	85U	89U	84U	84U	92U	90U
Toxaphene		170U	170U	180U	170U	170U	180U	180U
Aroclor-1016		84U	85U	89U	84U	84U	92U	90U
Aroclor-1221		84U	85U	89U	84U	84U	92U	90U
Aroclor-1232		84U	85U	89U	84U	84U	92U	90U
Aroclor-1242		84U	85U	89U	84U	84U	92U	90U
Aroclor-1248		84U	85U	89U	84U	84U	92U	90U
Aroclor-1254		170U	170U	180U	170U	170U	180U	180U
Aroclor-1260		170U	170U	180U	170U	170U	180U	180U

CAMP LEJEUNE - HPIA
 PESTICIDES IN SOIL SAMPLES
 Concentration in ug/kg

CHART = SOIL-P14

PESTICIDE/PCB	depth:	SB-27			SB-28		
		HPS027-1	HPS027-2	HPS027-3	HPS028-1	HPS028-2	HPS028-3
		2-4'	4-6'	8-10'	0-2'	2-4'	8-10'
alpha-BHC		8.5U	8.7U	9.7U	8.6U	8.8U	9.7U
beta-BHC		8.5U	8.7U	9.7U	8.6U	8.8U	9.7U
delta-BHC		8.5U	8.7U	9.7U	8.6U	8.8U	9.7U
gamma-BHC (Lindane)		8.5U	8.7U	9.7U	8.6U	8.8U	9.7U
Heptachlor		8.5U	8.7U	9.7U	8.6U	8.8U	9.7U
Aldrin		8.5U	8.7U	9.7U	8.6U	8.8U	9.7U
Heptachlor epoxide		8.5U	8.7U	9.7U	8.6U	8.8U	9.7U
Endosulfan I		8.5U	8.7U	9.7U	8.6U	8.8U	9.7U
Dieldrin		17U	17U	19U	17U	18U	19U
4,4'-DDE		17U	17U	19U	17U	18U	19U
Endrin		17U	17U	19U	17U	18U	19U
Endosulfan II		17U	17U	19U	17U	18U	19U
4,4'-DDD		17U	17U	19U	17U	18U	19U
Endosulfan sulfate		17U	17U	19U	17U	18U	19U
4,4'-DDT		17U	17U	19U	17U	18U	19U
Methoxychlor		85U	87U	97U	86U	88U	97U
Endrin ketone		17U	17U	19U	17U	18U	19U
alpha-Chlordane		85U	87U	97U	86U	88U	97U
gamma-Chlordane		85U	87U	97U	86U	88U	97U
Toxaphene		170U	170U	190U	170U	180U	190U
Aroclor-1016		85U	87U	97U	86U	88U	97U
Aroclor-1221		85U	87U	97U	86U	88U	97U
Aroclor-1232		85U	87U	97U	86U	88U	97U
Aroclor-1242		85U	87U	97U	86U	88U	97U
Aroclor-1248		85U	87U	97U	86U	88U	97U
Aroclor-1254		170U	170U	190U	170U	180U	190U
Aroclor-1260		170U	170U	190U	170U	180U	190U

APPENDIX I

**CHARACTERIZATION INVESTIGATION
SHALLOW MONITOR WELLS
ANALYTICAL RESULTS**

ANALYTICAL DATA

**SHALLOW GROUNDWATER MONITORING WELLS
SET 1 DATA**

PROJECT NUMBER 86447 0400 PROJECT NAME NAVY - LEJEUNE
 FIELD GROUP LJHP-1 LAB COORDINATOR J.D. SHAMIS

PARAMETERS	STORET #	SAMPLE ID/#													
		HPGW14 LJHP-1 16	HPGW15 LJHP-1 17	HPGW16 LJHP-1 18	HPGW17 LJHP-1 19	HPGW18 LJHP-1 20	HPGW19 LJHP-1 21	HPGW20 LJHP-1 22	HPGW21 LJHP-1 23	HPGW22 LJHP-1 24	HPGW23 LJHP-1 25	HPGW24 LJHP-1 26	HPGW25 LJHP-1 27	HPGW26 LJHP-1 28	HPGW29 LJHP-1 31
UNITS	METHOD														
DATE		01/14/87	01/15/87	01/15/87	01/15/87	01/15/87	01/16/87	01/16/87	01/16/87	01/19/87	01/19/87	01/19/87	01/19/87	01/19/87	01/20/87
TIME		17:37	10:46	12:27	13:56	17:25	10:12	11:50	14:35	10:20	11:30	14:00	14:50	16:30	11:20
LEAD, TOTAL	1051	<27.0	46.0	45.0	<27.0	<27.0	<27.0	46.0	<27.0	27.0	38.0	<27.0	<27.0	31.0	<27.0
UG/L	ICAP														
OIL&GR, IR	560	0.2	<0.1	0.2	<0.1	<0.1	0.2	<0.1	0.2	1	0.6	0.1	0.2	0.2	0.2
MG/L	1														
BENZENE	34030	<1.0	<1.0	<1.0	<1.0	<1.0	<1.0	<1.0	<1.0	<1.0	<10	2.0	<1.0	<1.0	<1.0
UG/L	GMS														
BROMODICHLOROMETHANE	32101	<2.2	<2.2	<2.2	<2.2	<2.2	<2.2	<2.2	<2.2	<2.2	<2.2	<22	<220	<2.2	<2.2
UG/L	GMS														
BROMOFORM	32104	<4.7	<4.7	<4.7	<4.7	<4.7	<4.7	<4.7	<4.7	<4.7	<4.7	<47	<470	<4.7	<4.7
UG/L	GMS														
BROMOMETHANE	34413	<5.8	<5.8	<5.8	<5.8	<5.8	<5.8	<5.8	<5.8	<5.8	<5.8	<58	<580	<5.8	<5.8
UG/L	GMS														
CARBON TETRACHLORIDE	32102	<2.8	<2.8	<2.8	<2.8	<2.8	<2.8	<2.8	<2.8	<2.8	<2.8	<28	<280	<2.8	<2.8
UG/L	GMS														
CHLOROBENZENE	34301	<6.0	<6.0	<6.0	<6.0	<6.0	<6.0	<6.0	<6.0	<6.0	<60	<600	<6.0	<6.0	<6.0
UG/L	GMS														
CHLOROETHANE	34311	<8.2	<8.2	<8.2	<8.2	<8.2	<8.2	<8.2	<8.2	<8.2	<82	<820	<8.2	<8.2	<8.2
UG/L	GMS														
2-CHLOROETHYL VINYL ETHER	34576	<15	<15	<15	<15	<26	<15	<15	<15	<15	<150	<1500	<15	<15	<15
UG/L	GMS														
CHLOROFORM	32106	<1.6	<1.6	<1.6	<1.6	<1.6	<1.6	<1.6	<1.6	<1.6	<16	<160	<1.6	<1.6	<1.6
UG/L	GMS														
CHLOROMETHANE	34418	<4.3	<4.3	<4.3	<4.3	<4.3	<4.3	<4.3	<4.3	<4.3	<43	<430	<4.3	<4.3	<4.3
UG/L	GMS														
DIBROMOCHLOROMETHANE	32105	<3.1	<3.1	<3.1	<3.1	<3.1	<3.1	<3.1	<3.1	<3.1	<31	<310	<3.1	<3.1	<3.1
UG/L	GMS														
1,1-DICHLOROETHANE	34496	<4.7	<4.7	<4.7	<4.7	<4.7	<4.7	<4.7	<4.7	<4.7	<47	12	<4.7	<4.7	<4.7
UG/L	GMS														
1,2-DICHLOROETHANE	34531	<2.8	<2.8	<2.8	<2.8	<2.8	<2.8	<2.8	<2.8	<2.8	<28	<280	<2.8	<2.8	<2.8
UG/L	GMS														
1,1-DICHLOROETHYLENE	34501	<2.8	<2.8	<2.8	<2.8	<2.8	<2.8	<2.8	<2.8	<2.8	<28	<280	<2.8	<2.8	<2.8
UG/L	GMS														
TRANS-1,2-DICHLORO ETHENE	34546	<1.6	<1.6	<1.6	<1.6	<1.6	2.5	<1.6	<1.6	<1.6	830	6400	<1.6	<1.6	<1.6
UG/L	GMS														
1,2-DICHLOROPROPANE	34541	<6.0	<6.0	<6.0	<6.0	<6.0	<6.0	<6.0	<6.0	<6.0	<60	<600	<6.0	<6.0	<6.0
UG/L	GMS														
CIS-1,3-DICHLORO PROPENE	34704	<5.0	<5.0	<5.0	<5.0	<5.0	<5.0	<5.0	<5.0	<5.0	<50	<500	<5.0	<5.0	<5.0
UG/L	GMS														
TRANS-1,3-DICHLORO PROPENE	34699	<6.4	<6.4	<6.4	<6.4	<6.4	<6.4	<6.4	<6.4	<6.4	<64	<640	<6.4	<6.4	<6.4
UG/L	GMS														

PROJECT NUMBER 86447 0400 PROJECT NAME NAVY - LEJEUNE
 FIELD GROUP LJHP-1 LAB COORDINATOR J.D. SHAMIS

SAMPLE ID/#

PARAMETERS UNITS	STORET # METHOD	HPGW14	HPGW15	HPGW16	HPGW17	HPGW18	HPGW19	HPGW20	HPGW21	HPGW22	HPGW23	HPGW24	HPGW25	HPGW26	HPGW29
		LJHP-1 16	LJHP-1 17	LJHP-1 18	LJHP-1 19	LJHP-1 20	LJHP-1 21	LJHP-1 22	LJHP-1 23	LJHP-1 24	LJHP-1 25	LJHP-1 26	LJHP-1 27	LJHP-1 28	LJHP-1 31
DATE TIME		01/14/87 17:37	01/15/87 10:46	01/15/87 12:27	01/15/87 13:56	01/15/87 17:25	01/16/87 10:12	01/16/87 11:50	01/16/87 14:35	01/19/87 10:20	01/19/87 11:30	01/19/87 14:00	01/19/87 14:50	01/19/87 16:30	01/20/87 11:20
ETHYLBENZENE UG/L	34371 GMS	<7.2	<7.2	<7.2	<7.2	<7.2	<7.2	<7.2	<7.2	<7.2	<72	<720	<7.2	<7.2	<7.2
METHYLENE CHLORIDE UG/L	34423 GMS	<2.8	<2.8	<2.8	<2.8	<2.8	<2.8	<2.8	<2.8	<2.8	<28	<280	<2.8	<2.8	<2.8
1,1,2,2-TETRACHLORO ETHANE UG/L	34516 GMS	<4.1	<4.1	<4.1	<4.1	<4.1	<4.1	<4.1	<4.1	<4.1	<41	<410	<4.1	<4.1	<4.1
TETRACHLOROETHENE UG/L	34475 GMS	<3.0	<3.0	<3.0	<3.0	<3.0	<3.0	<3.0	<3.0	<3.0	<30	<300	<3.0	<3.0	<3.0
TOLUENE UG/L	34010 GMS	<6.0	<6.0	<6.0	<6.0	<6.0	<6.0	<6.0	<6.0	<6.0	<60	<600	<6.0	<6.0	<6.0
1,1,1-TRICHL'ETHANE UG/L	34506 GMS	<3.8	<3.8	<3.8	<3.8	<3.8	<3.8	<3.8	<3.8	<3.8	<38	<380	<3.8	<3.8	<3.8
1,1,2-TRICHL'ETHANE UG/L	34511 GMS	<5.0	<5.0	<5.0	<5.0	<5.0	<5.0	<5.0	<5.0	<5.0	<50	<500	<5.0	<5.0	<5.0
TRICHLOROETHENE UG/L	39180 GMS	<3.0	<3.0	<3.0	<3.0	<1.0	6.0	<3.0	<3.0	<3.0	830	57	<3.0	<3.0	<3.0
TRICHLOROFLUORO- METHANE UG/L	34488 GMS	<3.2	<3.2	<3.2	<3.2	<3.2	<3.2	<3.2	<3.2	<3.2	<32	<320	<3.2	<3.2	<3.2
VINYL CHLORIDE UG/L	39175 GMS	<1.0	<1.0	<1.0	<1.0	<1.0	<1.0	<1.0	<1.0	<1.0	<10	190	<1.0	<1.0	<1.0
ACROLEIN UG/L	34210 GMS	<100	<100	<100	<100	<100	<100	<100	<100	<100	<1000	<10000	<100	<100	<100
ACRYLONITRILE UG/L	34215 GMS	<100	<100	<100	<100	<100	<100	<100	<100	<100	<1000	<10000	<100	<100	<100
DICHLORODIFLUORO- METHANE UG/L	34668 GMS	<10	<10	<10	<10	<10	<10	<10	<10	<10	<100	<1000	<10	<10	<10
M-XYLENE UG/L	98553 GMS	<12	<12	<12	<12	<12	<12	<12	<12	<12	<120	<1200	<12	<12	<12
O-AND/OR-P XYLENE UG/L	98554 GMS	<12	<12	<12	<12	<12	<12	<12	<12	<12	<120	<1200	<12	<12	<12
METHYL ETHYL KETONE UG/L	81595 GMS	<48	<48	<48	<48	<48	<48	<48	<48	<48	<480	<4800	<48	<48	<48
METHYL ISOBUT'KETONE UG/L	81596 GMS	<12	<12	<12	<12	<12	<12	<12	<12	<12	<120	<1200	<12	<12	<12

ANALYTICAL DATA

**SHALLOW GROUNDWATER MONITORING WELLS
SET 2 DATA**

PROJECT NUMBER 86447 0404
FIELD GROUP LJHP-2

PROJECT NAME NAVY - LEJEUNE HP2
LAB COORDINATOR J.D. SHAMIS

SAMPLE ID/#

PARAMETERS	STORET #	SAMPLE ID/#																
		UNITS	METHOD	22GW1 LJHP-2 1	22GW2 LJHP-2 2	HPGW1 LJHP-2 3	HPGW2 LJHP-2 4	HPGW3 LJHP-2 5	HPGW4 LJHP-2 6	HPGW5 LJHP-2 7	HPGW6 LJHP-2 8	HPGW7 LJHP-2 9	HPGW8 LJHP-2 10	HPGW9 LJHP-2 11	HPGW10 LJHP-2 12	HPGW11 LJHP-2 13	HPGW12 LJHP-2 14	HPGW13 LJHP-2 15
DATE			03/08/87	03/08/87	03/08/87	03/08/87	03/08/87	03/08/87	03/08/87	03/08/87	03/08/87	03/09/87	03/09/87	03/09/87	03/09/87	03/09/87	03/09/87	03/09/87
TIME			11:03	11:30	12:45	16:18	14:20	15:12	16:55	17:10	10:05	11:10	10:30	11:20	12:19	12:33	13:45	
LEAD, TOTAL	1051	UG/L	29.0	<27.0	<27.0	<27.0	<27.0	<27.0	<27.0	<27.0	29.0	<27.0	92.0	<27.0	<27.0	<27.0	<27.0	
	ICAP																	
OIL&GR, IR	560	MG/L	11	<0.1	<0.1	<0.1	0.2	0.3	<0.1	<0.1	0.2	<0.1	11	<0.1	0.6	<0.1	<0.1	
BENZENE	34030	UG/L	10000	<1.0	3.9	<1.0	<1.0	3.2	<1.0	<1.0	<1.0	<1.0	<250	<1.0	<1.0	<1.0	<1.0	
	GMS																	
BROMODICHLOROMETHANE	32101	UG/L	<2200	<2.2	<2.2	<2.2	<2.2	<2.2	<2.2	<2.2	<2.2	<2.2	<550	<2.2	<2.2	<2.2	<2.2	
BROMOFORM	32104	UG/L	<4700	<4.7	<4.7	<4.7	<4.7	<4.7	<4.7	<4.7	<4.7	<4.7	<1200	<4.7	<4.7	<4.7	<4.7	
BROMOMETHANE	34413	UG/L	<5800	<5.8	<5.8	<5.8	<5.8	<5.8	<5.8	<5.8	<5.8	<5.8	<1500	<5.8	<5.8	<5.8	<5.8	
CARBON TETRACHLORIDE	32102	UG/L	<2800	<2.8	<2.8	<2.8	<2.8	<2.8	<2.8	<2.8	<2.8	<2.8	<700	<2.8	<2.8	<2.8	<2.8	
CHLOROBENZENE	34301	UG/L	<6000	<6.0	<6.0	<6.0	<6.0	<6.0	<6.0	<6.0	<6.0	<6.0	<1500	<6.0	<6.0	<6.0	<6.0	
CHLOROETHANE	34311	UG/L	<8200	<8.2	<8.2	<8.2	<8.2	<8.2	<8.2	<8.2	<8.2	<8.2	<2100	<8.2	<8.2	<8.2	<8.2	
2-CHLOROETHYL VINYL ETHER	34576	UG/L	<15000	<15	<15	<15	<15	<15	<15	<15	<15	<15	<3800	<15	<15	<15	<15	
CHLOROFORM	32106	UG/L	<1600	<1.6	<1.6	<1.6	<1.6	<1.6	<1.6	<1.6	<1.6	<1.6	<400	<1.6	2.2	<1.6	<1.6	
CHLOROMETHANE	34418	UG/L	<4300	<4.3	<4.3	<4.3	<4.3	<4.3	<4.3	<4.3	<4.3	<4.3	<1100	<4.3	<4.3	<4.3	<4.3	
DIBROMOCHLOROMETHANE	32105	UG/L	<3100	<3.1	<3.1	<3.1	<3.1	<3.1	<3.1	<3.1	<3.1	<3.1	<780	<3.1	<3.1	<3.1	<3.1	
1,1-DICHLOROETHANE	34496	UG/L	<4700	<4.7	<4.7	<4.7	<4.7	<4.7	<4.7	<4.7	<4.7	<4.7	<1200	<4.7	<4.7	<4.7	<4.7	
1,2-DICHLOROETHANE	34531	UG/L	<2800	<2.8	<2.8	<2.8	<2.8	<2.8	<2.8	<2.8	<2.8	<2.8	<700	<2.8	<2.8	<2.8	<2.8	
1,1-DICHLOROETHYLENE	34501	UG/L	<2800	<2.8	<2.8	<2.8	<2.8	<2.8	<2.8	<2.8	<2.8	<2.8	<700	<2.8	<2.8	<2.8	<2.8	
TRANS-1,2-DICHLORO ETHENE	34546	UG/L	<1600	<1.6	<1.6	<1.6	<1.6	2.2	<1.6	<1.6	<1.6	<1.6	<400	<1.6	7.2	<1.6	<1.6	
1,2-DICHLOROPROPANE	34541	UG/L	<6000	<6.0	<6.0	<6.0	<6.0	<6.0	<6.0	<6.0	<6.0	<6.0	<1500	<6.0	<6.0	<6.0	<6.0	
CIS-1,3-DICHLORO PROPENE	34704	UG/L	<5000	<5.0	<5.0	<5.0	<5.0	<5.0	<5.0	<5.0	<5.0	<5.0	<1300	<5.0	<5.0	<5.0	<5.0	
TRANS-1,3-DICHLORO PROPENE	34699	UG/L	<6400	<6.4	<6.4	<6.4	<6.4	<6.4	<6.4	<6.4	<6.4	<6.4	<1600	<6.4	<6.4	<6.4	<6.4	

PROJECT NUMBER 86447 0404
FIELD GROUP LJHP-2

PROJECT NAME NAVY - LEJEUNE HP2
LAB COORDINATOR J.D. SHAMIS

PARAMETERS UNITS	STORET # METHOD	SAMPLE ID/#														
		22GW1 LJHP-2 1	22GW2 LJHP-2 2	HPGW1 LJHP-2 3	HPGW2 LJHP-2 4	HPGW3 LJHP-2 5	HPGW4 LJHP-2 6	HPGW5 LJHP-2 7	HPGW6 LJHP-2 8	HPGW7 LJHP-2 9	HPGW8 LJHP-2 10	HPGW9 LJHP-2 11	HPGW10 LJHP-2 12	HPGW11 LJHP-2 13	HPGW12 LJHP-2 14	HPGW13 LJHP-2 15
DATE TIME		03/08/87 11:03	03/08/87 11:30	03/08/87 12:45	03/08/87 16:18	03/08/87 14:20	03/08/87 15:12	03/08/87 16:55	03/08/87 17:10	03/09/87 10:05	03/09/87 11:10	03/09/87 10:30	03/09/87 11:20	03/09/87 12:19	03/09/87 12:33	03/09/87 13:45
ETHYLBENZENE UG/L	34371 GMS	<7200	<7.2	<7.2	<7.2	9.0	<7.2	<7.2	<7.2	<7.2	<7.2	<1800	<7.2	<7.2	<7.2	<7.2
METHYLENE CHLORIDE UG/L	34423 GMS	<2800	<2.8	<2.8	<2.8	<2.8	<2.8	<2.8	<2.8	<2.8	<2.8	<700	<2.8	<2.8	<2.8	<2.8
1,1,2-TETRACHLORO ETHANE UG/L	34516 GMS	<4100	<4.1	<4.1	<4.1	<4.1	<4.1	<4.1	<4.1	<4.1	<4.1	<1000	<4.1	<4.1	<4.1	<4.1
TETRACHLOROETHENE UG/L	34475 GMS	<2000	<3.0	<3.0	<3.0	<3.0	<3.0	<3.0	<3.0	<3.0	<3.0	<750	<3.0	<3.0	3.6	<3.0
TOLUENE UG/L	34010 GMS	18000	<6.0	12	<6.0	<6.0	8.2	<6.0	<6.0	<6.0	<6.0	<1500	<6.0	<6.0	<6.0	<6.0
1,1,1-TRICHL'ETHANE UG/L	34506 GMS	<3800	<3.8	<3.8	<3.8	13	<3.8	<3.8	<3.8	<3.8	<3.8	<950	<3.8	<3.8	<3.8	<3.8
1,1,2-TRICHL'ETHANE UG/L	34511 GMS	<5000	<5.0	<5.0	<5.0	<5.0	<5.0	<5.0	<5.0	<5.0	<5.0	<1300	<5.0	<5.0	<5.0	<5.0
TRICHLOROETHENE UG/L	39180 GMS	<1000	<3.0	<3.0	<3.0	<3.0	<3.0	<3.0	<3.0	<3.0	<3.0	6100	8.6	34	<3.0	<3.0
TRICHLOROFLUORO- METHANE UG/L	34488 GMS	<3200	<3.2	<3.2	<3.2	<3.2	<3.2	<3.2	<3.2	<3.2	96	<800	<3.2	<3.2	<3.2	<3.2
VINYL CHLORIDE UG/L	39175 GMS	<1000	<1.0	<1.0	<1.0	<1.0	<1.0	<1.0	<1.0	<1.0	<1.0	<250	<1.0	<1.0	<1.0	<1.0
ACROLEIN UG/L	34210 GMS	<100000	<100	<100	<100	<100	<100	<100	<100	<100	<100	<25000	<100	<100	<100	<100
ACRYLONITRILE UG/L	34215 GMS	<100000	<100	<100	<100	<100	<100	<100	<100	<100	<100	<25000	<100	<100	<100	<100
DICHLORODIFLUORO- METHANE UG/L	34668 GMS	<10000	<10	<10	<10	<10	<10	<10	<10	<10	<10	<2500	<10	<10	<10	<10
M-XYLENE UG/L	98553 GMS	<12000	<12	<12	<12	<12	<12	<12	<12	<12	<12	<3000	<12	<12	<12	<12
O-AND/OR-P XYLENE UG/L	98554 GMS	<12000	<12	<12	<12	<12	<12	<12	<12	<12	<12	<3000	<12	<12	<12	<12
METHYL ETHYL KETONE UG/L	81595 GMS	<48000	<48	<48	<48	<48	<48	<48	<48	<48	<48	<12000	<48	<48	<48	<48
METHYL ISOBUT'KETONE UG/L	81596 GMS	<12000	<12	<12	<12	<12	<12	<12	<12	<12	<12	<3000	<12	<12	<12	<12

PROJECT NUMBER 86447 0404 PROJECT NAME NAVY - LEJEUNE HP2
 FIELD GROUP LJHP-2 LAB COORDINATOR J.D. SHAMIS

PARAMETERS	UNITS	STORET # METHOD	SAMPLE ID/#														
			HPGW14 LJHP-2 16	HPGW15 LJHP-2 17	HPGW16 LJHP-2 18	HPGW17 LJHP-2 19	HPGW18 LJHP-2 20	HPGW19 LJHP-2 21	HPGW20 LJHP-2 22	HPGW21 LJHP-2 23	HPGW22 LJHP-2 24	HPGW23 LJHP-2 25	HPGW24 LJHP-2 26	HPGW25 LJHP-2 27	HPGW26 LJHP-2 28	HPGW29 LJHP-2 29	
DATE			03/09/87	03/09/87	03/10/87	03/10/87	03/10/87	03/10/87	03/10/87	03/10/87	03/10/87	03/11/87	03/11/87	03/11/87	03/11/87	03/12/87	03/12/87
TIME			13:55	15:10	12:07	12:26	11:40	13:35	13:50	16:26	10:42	10:25	12:01	12:15	13:10	14:00	
LEAD, TOTAL	UG/L	1051 ICAP	<27.0	<27.0	41.0	<27.0	<27.0	<27.0	33.0	<27.0	<27.0	<27.0	<27.0	<27.0	<27.0	52.0	
OIL&GR, IR	MG/L	560 I	<0.1	<0.1	3	3	2	2	3	2	2	3	2	0.3	2	<0.1	
BENZENE	UG/L	34030 GMS	<1.0	<1.0	<1.0	<1.0	<1.0	<1.0	<1.0	<1.0	<1.0	<100	<100	<1.0	<1.0	<1.0	
BROMODICHLOROMETHANE	UG/L	32101 GMS	<2.2	<2.2	<2.2	<2.2	<2.2	<2.2	<2.2	<2.2	<2.2	<220	<220	<2.2	<2.2	<2.2	
BROMOFORM	UG/L	32104 GMS	<4.7	<4.7	<4.7	<4.7	<4.7	<4.7	<4.7	<4.7	<4.7	<470	<470	<4.7	<4.7	<4.7	
BROMOMETHANE	UG/L	34413 GMS	<5.8	<5.8	<5.8	<5.8	<5.8	<5.8	<5.8	<5.8	<5.8	<580	<580	<5.8	<5.8	<5.8	
CARBON TETRACHLORIDE	UG/L	32102 GMS	<2.8	<2.8	<2.8	<2.8	<2.8	<2.8	<2.8	<2.8	<2.8	<280	<280	<2.8	<2.8	<2.8	
CHLOROBENZENE	UG/L	34301 GMS	<6.0	<6.0	<6.0	<6.0	<6.0	<6.0	<6.0	<6.0	<6.0	<600	<600	<6.0	<6.0	<6.0	
CHLOROETHANE	UG/L	34311 GMS	<8.2	<8.2	<8.2	<8.2	<8.2	<8.2	<8.2	<8.2	<8.2	<820	<820	<8.2	<8.2	<8.2	
2-CHLOROETHYL VINYL ETHER	UG/L	34576 GMS	<15	<15	<15	<15	<15	<15	<26	<26	<26	<1500	<1500	<26	<26	<15	
CHLOROFORM	UG/L	32106 GMS	<1.6	<1.6	<1.6	<1.6	<1.6	<1.6	<1.6	<1.6	<1.6	<160	<160	<1.6	<1.6	<1.6	
CHLOROMETHANE	UG/L	34418 GMS	<4.3	<4.3	<4.3	<4.3	<4.3	<4.3	<4.3	<4.3	<4.3	<430	<430	<4.3	<4.3	<4.3	
DIBROMOCHLOROMETHANE	UG/L	32105 GMS	<3.1	<3.1	<3.1	<3.1	<3.1	<3.1	<3.1	<3.1	<3.1	<310	<310	<3.1	<3.1	<3.1	
1,1-DICHLOROETHANE	UG/L	34496 GMS	<4.7	<4.7	<4.7	<4.7	<4.7	<4.7	<4.7	<4.7	<4.7	<470	<470	<4.7	<4.7	<4.7	
1,2-DICHLOROETHANE	UG/L	34531 GMS	<2.8	<2.8	<2.8	<2.8	<2.8	<2.8	<2.8	<2.8	<2.8	<280	<280	<2.8	<2.8	<2.8	
1,1-DICHLOROETHYLENE	UG/L	34501 GMS	<2.8	<2.8	<2.8	<2.8	<2.8	<2.8	<2.8	<2.8	<2.8	<280	<280	<2.8	<2.8	<2.8	
TRANS-1,2-DICHLORO ETHENE	UG/L	34546 GMS	<1.6	<1.6	<1.6	<1.6	<1.6	<1.6	<1.6	<1.6	<1.6	6100	4300	<1.6	<1.6	<1.6	
1,2-DICHLOROPROPANE	UG/L	34541 GMS	<6.0	<6.0	<6.0	<6.0	<6.0	<6.0	<6.0	<6.0	<6.0	<600	<600	<6.0	<6.0	<6.0	
CIS-1,3-DICHLORO PROPENE	UG/L	34704 GMS	<5.0	<5.0	<5.0	<5.0	<5.0	<5.0	<5.0	<5.0	<5.0	<500	<500	<5.0	<5.0	<5.0	
TRANS-1,3-DICHLORO PROPENE	UG/L	34699 GMS	<6.4	<6.4	<6.4	<6.4	<6.4	<6.4	<6.4	<6.4	<6.4	<640	<640	<6.4	<6.4	<6.4	

ANALYTICAL DATA

**SHALLOW GROUNDWATER MONITORING WELLS
SET 3 DATA**

APPENDIX J

**SUPPLEMENTAL CHARACTERIZATION INVESTIGATION
SHALLOW MONITOR WELLS
ANALYTICAL RESULTS**

CAMP LEJEUNE - HPIA
 VOLATILE ORGANIC COMPOUNDS IN GROUNDWATER (SHALLOW WELLS)
 Concentration in ug/l

CHART = HPVOL2

wp8b\hp-vol.wr1 (2)

COMPOUND	HPGW8	HPGW9-1	HPGW10	HPGW11	HPGW12	HPGW12D (GWDUP2)	HPGW13	HPGW14
Chloromethane	10.U	10.U	10.U	10.U	10.U	10.U	10.U	10.U
Bromomethane	10.U	10.U	10.U	10.U	10.U	10.U	10.U	10.U
Vinyl Chloride	10.U	10.U	10.U	10.U	10.U	10.U	10.U	10.U
Chloroethane	10.U	10.U	10.U	10.U	10.U	10.U	10.U	10.U
Methylene Chloride	5.U	5.U	5.U	5.U	5.U	3.BJ	1.J	5.U
Acetone	10.U	10.U	10.U	10.U	10.U	10.U	10.U	10.U
Carbon Disulfide	5.U	13.	5.U	11.	5.U	5.U	5.U	5.U
1,1-Dichloroethene	5.U	5.U	5.U	5.U	5.U	5.U	5.U	5.U
1,1-Dichloroethane	5.U	5.U	5.U	5.U	5.U	5.U	5.U	5.U
1,2-Dichloroethene (total)	5.U	1200.	5.U	5.U	5.U	5.U	5.U	5.U
Chloroform	5.U	15.	5.U	5.U	5.U	5.U	5.U	5.U
1,2-Dichloroethane	5.U	5.U	5.U	5.U	5.U	5.U	5.U	5.U
2-Butanone	10.U	10.U	10.U	10.U	10.U	4.J	10.U	10.U
1,1,1-Trichloroethane	5.U	5.U	5.U	5.U	5.U	5.U	5.U	5.U
Carbon Tetrachloride	5.U	5.U	5.U	5.U	5.U	5.U	5.U	5.U
Vinyl Acetate	10.U	10.U	10.U	10.U	10.U	10.U	10.U	10.U
Bromodichloromethane	5.U	5.U	5.U	5.U	5.U	5.U	5.U	5.U
1,2-Dichloropropane	5.U	5.U	5.U	5.U	5.U	5.U	5.U	5.U
cis-1,3-Dichloropropene	5.U	5.U	5.U	5.U	5.U	5.U	5.U	5.U
Trichloroethene	2.J	14000.	5.U	5.U	5.U	5.U	5.U	5.U
Dibromochloromethane	5.U	5.U	5.U	5.U	5.U	5.U	5.U	5.U
1,1,2-Trichloroethane	5.U	5.U	5.U	5.U	5.U	5.U	5.U	5.U
Benzene	5.U	5.U	5.U	5.U	5.U	5.U	5.U	5.U
trans-1,3-Dichloropropene	5.U	5.U	5.U	5.U	5.U	5.U	5.U	5.U
Bromoform	5.U	5.U	5.U	5.U	5.U	5.U	5.U	5.U
4-Methyl-2-Pentanone	10.U	10.U	10.U	10.U	10.U	10.U	10.U	10.U
2-Hexanone	10.U	10.U	10.U	10.U	10.U	10.U	10.U	10.U
Tetrachloroethene	5.U	5.U	5.U	5.U	5.U	5.U	5.U	5.U
1,1,2,2-Tetrachloroethane	5.U	5.U	5.U	5.U	5.U	5.U	5.U	5.U
Toluene	5.U	330.J	5.U	5.U	5.U	5.U	5.U	5.U
Chlorobenzene	5.U	5.U	5.U	5.U	5.U	5.U	5.U	5.U
Ethylbenzene	5.U	700.	5.U	5.U	5.U	5.U	5.U	5.U
Styrene	5.U	5.U	5.U	5.U	5.U	5.U	5.U	5.U
Xylene (total)	5.U	3300.	5.U	5.U	5.U	5.U	5.U	5.U

CAMP LEJEUNE - HPIA
 VOLATILE ORGANIC COMPOUNDS IN GROUNDWATER (SHALLOW WELLS)
 Concentration in ug/l

CHART = HPVOL3

wp8b\hp-vol.wr1 (3)

COMPOUND	HPGW15	HPGW16	HPGW17-1	HPGW19	HPGW20	HPGW21	HPGW22	HPGW23
Chloromethane	10.U	10.U	10.U	10.U	10.U	10.U	10.U	10.U
Bromomethane	10.U	10.U	10.U	10.U	10.U	10.U	10.U	10.U
Vinyl Chloride	10.U	10.U	10.U	10.U	10.U	10.U	10.U	8.J
Chloroethane	10.U	10.U	10.U	10.U	10.U	10.U	10.U	10.U
Methylene Chloride	5.U	5.U	5.U	5.U	.9J	4.J	9.	5.U
Acetone	10.U	10.U	10.U	10.U	10.U	4.8J	10.U	10.U
Carbon Disulfide	5.U	5.U	5.U	5.U	2.J	5.U	5.U	5.
1,1-Dichloroethene	5.U	5.U	5.U	5.U	5.U	5.U	5.U	5.U
1,1-Dichloroethane	5.U	5.U	5.U	5.U	5.U	5.U	5.U	5.U
1,2-Dichloroethene (total)	7.	5.U	5.U	.8J	5.U	5.U	5.U	8900.
Chloroform	5.U	5.U	5.U	5.U	5.U	5.U	5.U	5.U
1,2-Dichloroethane	5.U	5.U	5.U	5.U	5.U	5.U	5.U	5.U
2-Butanone	10.U	10.U	10.U	10.U	10.U	10.U	10.U	10.U
1,1,1-Trichloroethane	5.U	5.U	5.U	5.U	5.U	5.U	5.U	5.U
Carbon Tetrachloride	5.U	5.U	5.U	5.U	5.U	5.U	5.U	5.U
Vinyl Acetate	10.U	10.U	10.U	10.U	10.U	10.U	10.U	10.U
Bromodichloromethane	5.U	5.U	5.U	5.U	5.U	5.U	5.U	5.U
1,2-Dichloropropane	5.U	5.U	5.U	5.U	5.U	5.U	5.U	5.U
cis-1,3-Dichloropropene	5.U	5.U	5.U	5.U	5.U	5.U	5.U	5.U
Trichloroethene	4.J	5.U	5.U	2.J	5.U	3.J	5.U	3700.
Dibromochloromethane	5.U	5.U	5.U	5.U	5.U	5.U	5.U	5.U
1,1,2-Trichloroethane	5.U	5.U	5.U	5.U	5.U	5.U	5.U	5.U
Benzene	5.U	5.U	5.U	5.U	5.U	5.U	5.U	24.
trans-1,3-Dichloropropene	5.U	5.U	5.U	5.U	5.U	5.U	5.U	5.U
Bromoform	5.U	5.U	5.U	5.U	5.U	5.U	5.U	5.U
4-Methyl-2-Pentanone	10.U	10.U	10.U	10.U	10.U	10.U	10.U	10.U
2-Hexanone	10.U	10.U	10.U	10.U	10.U	10.U	10.U	10.U
Tetrachloroethene	5.U	5.U	5.U	2.J	5.U	5.U	5.U	5.U
1,1,2,2-Tetrachloroethane	5.U	5.U	5.U	5.U	5.U	5.U	5.U	5.U
Toluene	5.U	5.U	5.U	5.U	5.U	5.U	5.U	13.
Chlorobenzene	5.U	5.U	5.U	5.U	5.U	5.U	5.U	5.U
Ethylbenzene	5.U	5.U	5.U	5.U	5.U	.9J	5.U	9.
Styrene	5.U	5.U	5.U	5.U	5.U	5.U	5.U	5.U
Xylene (total)	5.U	5.U	5.U	5.U	5.U	5.	5.U	41.

CAMP LEJEUNE - HPIA
VOLATILE ORGANIC COMPOUNDS IN GROUNDWATER (SHALLOW WELLS)
Concentration in ug/l

CHART = HPVOL4

wp8b\hp-vol.wr1 (4)

COMPOUND	HPGW24-1	HPGW25	HPGW26	HPGW26D (GWDUP8)	HPGW29	21GW1	22GW1	22GW2
Chloromethane	10.U	10.U	10.U	10.U	10.U	10.U	10.U	10.U
Bromomethane	10.U	10.U	10.U	10.U	10.U	10.U	10.U	10.U
Vinyl Chloride	25000.U	10.U	10.U	10.U	10.U	10.U	10.U	10.U
Chloroethane	10.U	10.U	10.U	10.U	10.U	10.U	10.U	10.U
Methylene Chloride	5.U	5.U	3.J	5.U	.9J	5.U	5.U	5.U
Acetone	10.U	10.U	7.BJ	6.BJ	10.U	10.U	10.U	10.U
Carbon Disulfide	7.	5.U	2.J	8.	5.U	5.U	5.U	5.U
1,1-Dichloroethene	65.	5.U	5.U	5.U	5.U	5.U	5.U	5.U
1,1-Dichloroethane	5.U	5.U	5.U	5.U	5.U	5.U	5.U	5.U
1,2-Dichloroethene (total)	42000.D	5.U	5.U	5.U	5.U	5.U	5.U	5.U
Chloroform	5.U	5.U	5.U	5.U	5.U	5.U	5.U	5.U
1,2-Dichloroethane	.8J	5.U	5.U	5.U	5.U	5.U	110.B	5.U
2-Butanone	10.U	10.U	10.U	10.U	10.U	10.U	10.U	10.U
1,1,1-Trichloroethane	5.U	5.U	5.U	5.U	5.U	5.U	5.U	5.U
Carbon Tetrachloride	5.U	5.U	5.U	5.U	5.U	5.U	5.U	5.U
Vinyl Acetate	10.U	10.U	10.U	10.U	10.U	10.U	10.U	10.U
Bromodichloromethane	5.U	5.U	5.U	5.U	5.U	5.U	5.U	5.U
1,2-Dichloropropane	5.U	5.U	5.U	5.U	5.U	5.U	5.U	5.U
cis-1,3-Dichloropropene	5.U	5.U	5.U	5.U	5.U	5.U	5.U	5.U
Trichloroethene	180.	5.U	5.U	5.U	5.U	5.U	5.J	5.U
Dibromochloromethane	5.U	5.U	5.U	5.U	5.U	5.U	5.U	5.U
1,1,2-Trichloroethane	3.J	5.U	5.U	5.U	5.U	5.U	5.U	5.U
Benzene	3.J	5.U	5.U	5.U	5.U	5.U	7900.	5.U
trans-1,3-Dichloropropene	5.U	5.U	5.U	5.U	5.U	5.U	5.U	5.U
Bromoform	5.U	5.U	5.U	5.U	5.U	5.U	5.U	5.U
4-Methyl-2-Pentanone	10.U	10.U	10.U	10.U	10.U	10.U	10.U	10.U
2-Hexanone	10.U	10.U	10.U	10.U	10.U	10.U	10.U	10.U
Tetrachloroethene	5.U	5.U	5.U	5.U	5.U	5.U	5.U	5.U
1,1,2,2-Tetrachloroethane	5.U	5.U	5.U	5.U	5.U	5.U	5.U	5.U
Toluene	13.	5.U	5.U	5.U	5.U	5.U	16000.	5.U
Chlorobenzene	5.U	5.U	5.U	5.U	5.U	5.U	5.U	5.U
Ethylbenzene	3.J	5.U	5.U	5.U	5.U	5.U	1900.J	5.U
Styrene	5.U	5.U	5.U	5.U	5.U	5.U	5.U	5.U
Xylene (total)	10.	5.U	5.U	5.U	5.U	5.U	9800.	5.U

CAMP LEJEUNE - HPIA
SEMI-VOLATILE ORGANIC COMPOUNDS IN GROUNDWATER (SHALLOW WELLS)
Concentration in ug/l

CHART = HPSV1A

wp8c\hp-sv.wr1 (1-A)

COMPOUND	HPGW1	HPGW2	HPGW3	HPGW4-1	HPGW4-1D (GWDUP5)	HPGW5	HPGW6	HPGW7
Phenol	10.U	10.U	10.U	10.U	10.U	10.U	10.U	10.U
bis(2-Chloroethyl)ether	10.U	10.U	10.U	10.U	10.U	10.U	10.U	10.U
2-Chlorophenol	10.U	10.U	10.U	10.U	10.U	10.U	10.U	10.U
1,3-Dichlorobenzene	10.U	10.U	10.U	10.U	10.U	10.U	10.U	10.U
1,4-Dichlorobenzene	10.U	10.U	10.U	10.U	10.U	10.U	10.U	10.U
Benzyl Alcohol	10.U	10.U	10.U	10.U	10.U	10.U	10.U	10.U
1,2-Dichlorobenzene	10.U	10.U	10.U	10.U	10.U	10.U	10.U	10.U
2-Methylphenol	10.U	10.U	10.U	10.U	10.U	10.U	10.U	10.U
bis(2-Chloroisopropyl)ether	10.U	10.U	10.U	10.U	10.U	10.U	10.U	10.U
4-Methylphenol	10.U	10.U	10.U	10.U	10.U	10.U	10.U	10.U
N-Nitroso-di-n-propylamine	10.U	10.U	10.U	10.U	10.U	10.U	10.U	10.U
Hexachloroethane	10.U	10.U	10.U	10.U	10.U	10.U	10.U	10.U
Nitrobenzene	10.U	10.U	10.U	10.U	10.U	10.U	10.U	10.U
Isophorone	10.U	10.U	10.U	10.U	10.U	10.U	10.U	10.U
2-Nitrophenol	10.U	10.U	10.U	10.U	10.U	10.U	10.U	10.U
2,4-Dimethylphenol	10.U	10.U	10.U	10.U	10.U	10.U	10.U	10.U
Benzoic acid	50.U	50.U	50.U	50.U	50.U	50.U	50.U	50.U
bis(2-Chloroethoxy)methane	10.U	10.U	10.U	10.U	10.U	10.U	10.U	10.U
2,4-Dichlorophenol	10.U	10.U	10.U	10.U	10.U	10.U	10.U	10.U
1,2,4-Trichlorobenzene	10.U	10.U	10.U	10.U	10.U	10.U	10.U	10.U
Naphthalene	10.U	10.U	10.U	10.U	10.U	10.U	10.U	10.U
4-Chloroaniline	10.U	10.U	10.U	10.U	10.U	10.U	10.U	10.U
Hexachlorobutadiene	10.U	10.U	10.U	10.U	10.U	10.U	10.U	10.U
4-Chloro-3-methylphenol	10.U	10.U	10.U	10.U	10.U	10.U	10.U	10.U
2-Methylnaphthalene	10.U	10.U	10.U	10.U	10.U	10.U	10.U	10.U
Hexachlorocyclopentadiene	10.U	10.U	10.U	10.U	10.U	10.U	10.U	10.U
2,4,6-Trichlorophenol	10.U	10.U	10.U	10.U	10.U	10.U	10.U	10.U
2,4,5-Trichlorophenol	50.U	50.U	50.U	50.U	50.U	50.U	50.U	50.U
2-Chloronaphthalene	10.U	10.U	10.U	10.U	10.U	10.U	10.U	10.U
2-Nitroaniline	50.U	50.U	50.U	50.U	50.U	50.U	50.U	50.U
Dimethylphthalate	10.U	10.U	10.U	10.U	10.U	10.U	10.U	10.U
Acenaphthylene	10.U	10.U	10.U	10.U	10.U	10.U	10.U	10.U
2,6-Dinitrotoluene	10.U	10.U	10.U	10.U	10.U	10.U	10.U	10.U

Camp Lejeune

PROJECT _____

PREPARED BY *John Guma*

DATE *April 1991*

CHECKED BY *Ed [unclear]*

DATE *5/6/91*

COMMENTS _____

CAMP LEJEUNE - HPIA
 SEMI-VOLATILE ORGANIC COMPOUNDS IN GROUNDWATER (SHALLOW WELLS)
 Concentration in ug/l

CHART = HPSV1B

wp8c\hp-sv.wr1 (1-B)

COMPOUND	HPGW1	HPGW2	HPGW3	HPGW4-1	HPGW4-1D (GWDUP5)	HPGW5	HPGW6	HPGW7
3-Nitroaniline	50.U	50.U	50.U	50.U	50.U	50.U	50.U	50.U
Acenaphthene	10.U	10.U	10.U	10.U	10.U	10.U	10.U	10.U
2,4-Dinitrophenol	50.U	50.U	50.U	50.U	50.U	50.U	50.U	50.U
4-Nitrophenol	50.U	50.U	50.U	50.U	50.U	50.U	50.U	50.U
Dibenzofuran	10.U	10.U	10.U	10.U	10.U	10.U	10.U	10.U
2,4-Dinitrotoluene	10.U	10.U	10.U	10.U	10.U	10.U	10.U	10.U
Diethylphthalate	10.U	10.U	10.U	10.U	10.U	10.U	10.U	10.U
4-Chlorophenyl-phenylether	10.U	10.U	10.U	10.U	10.U	10.U	10.U	10.U
Fluorene	10.U	10.U	10.U	10.U	10.U	10.U	10.U	10.U
4-Nitroaniline	50.U	50.U	50.U	50.U	50.U	50.U	50.U	50.U
4,6-Dinitro-2-methylphenol	50.U	50.U	50.U	50.U	50.U	50.U	50.U	50.U
N-Nitrosodiphenylamine	10.U	10.U	10.U	10.U	10.U	10.U	10.U	10.U
4-Bromophenyl-phenylether	10.U	10.U	10.U	10.U	10.U	10.U	10.U	10.U
Hexachlorobenzene	10.U	10.U	10.U	10.U	10.U	10.U	10.U	10.U
Pentachlorophenol	50.U	50.U	50.U	50.U	50.U	50.U	50.U	50.U
Phenanthrene	10.U	10.U	10.U	10.U	10.U	10.U	10.U	10.U
Anthracene	10.U	10.U	10.U	10.U	10.U	10.U	10.U	10.U
Di-n-butylphthalate	10.U	10.U	10.U	10.U	10.U	10.U	10.U	10.U
Fluoranthene	10.U	10.U	10.U	10.U	10.U	10.U	10.U	10.U
Pyrene	10.U	10.U	10.U	10.U	10.U	10.U	10.U	10.U
Butylbenzylphthalate	10.U	10.U	10.U	10.U	10.U	10.U	10.U	10.U
3,3'-Dichlorobenzidine	20.U	20.U	20.U	20.U	20.U	20.U	20.U	20.U
Benzo(a)anthracene	10.U	10.U	10.U	10.U	10.U	10.U	10.U	10.U
Chrysene	10.U	10.U	10.U	10.U	10.U	10.U	10.U	10.U
bis(2-Ethylhexyl)phthalate	10.U	10.U	10.U	10.U	10.U	10.U	10.U	10.U
Di-n-octylphthalate	10.U	10.U	10.U	10.U	10.U	10.U	10.U	10.U
Benzo(b)fluoranthene	10.U	10.U	10.U	10.U	10.U	10.U	10.U	10.U
Benzo(k)fluoranthene	10.U	10.U	10.U	10.U	10.U	10.U	10.U	10.U
Benzo(a)pyrene	10.U	10.U	10.U	10.U	10.U	10.U	10.U	10.U
Indeno(1,2,3-cd)pyrene	10.U	10.U	10.U	10.U	10.U	10.U	10.U	10.U
Dibenz(a,h)anthracene	10.U	10.U	10.U	10.U	10.U	10.U	10.U	10.U
Benzo(g,h,i)perylene	10.U	10.U	10.U	10.U	10.U	10.U	10.U	10.U

PROJECT Camp Lejeune
 PREPARED BY Quincy Guma
 DATE April 1991
 CHECKED BY E.O. Campbell
 DATE 5/6/91

COMMENTS

CAMP LEJEUNE - HPIA
SEMI-VOLATILE ORGANIC COMPOUNDS IN GROUNDWATER (SHALLOW WELLS)
Concentration in ug/l

CHART = HPSV2A

wp8c\hp-sv.wr1 (2-A)

COMPOUND	HPGW8	HPGW9-1	HPGW10	HPGW11	HPGW12	HPGW12D (GWDUP2)	HPGW13	HPGW14
Phenol	10.U	10.U	10.U	10.U	10.U	10.U	10.U	10.U
bis(2-Chloroethyl)ether	10.U	10.U	10.U	10.U	10.U	10.U	10.U	10.U
2-Chlorophenol	10.U	10.U	10.U	10.U	10.U	10.U	10.U	10.U
1,3-Dichlorobenzene	10.U	10.U	10.U	10.U	10.U	10.U	10.U	10.U
1,4-Dichlorobenzene	10.U	10.U	10.U	10.U	10.U	10.U	10.U	10.U
Benzyl Alcohol	10.U	10.U	10.U	10.U	10.U	10.U	10.U	10.U
1,2-Dichlorobenzene	10.U	10.U	10.U	10.U	10.U	10.U	10.U	10.U
2-Methylphenol	10.U	10.U	10.U	10.U	10.U	10.U	10.U	10.U
bis(2-Chloroisopropyl)ether	10.U	10.U	10.U	10.U	10.U	10.U	10.U	10.U
4-Methylphenol	10.U	10.U	10.U	10.U	10.U	10.U	10.U	10.U
N-Nitroso-di-n-propylamine	10.U	10.U	10.U	10.U	10.U	10.U	10.U	10.U
Hexachloroethane	10.U	10.U	10.U	10.U	10.U	10.U	10.U	10.U
Nitrobenzene	10.U	10.U	10.U	10.U	10.U	10.U	10.U	10.U
Isophorone	10.U	10.U	10.U	10.U	10.U	10.U	10.U	10.U
2-Nitrophenol	10.U	10.U	10.U	10.U	10.U	10.U	10.U	10.U
2,4-Dimethylphenol	10.U	10.U	10.U	10.U	10.U	10.U	10.U	10.U
Benzoic acid	50.U	50.U	50.U	50.U	50.U	50.U	50.U	50.U
bis(2-Chloroethoxy)methane	10.U	10.U	10.U	10.U	10.U	10.U	10.U	10.U
2,4-Dichlorophenol	10.U	10.U	10.U	10.U	10.U	10.U	10.U	10.U
1,2,4-Trichlorobenzene	10.U	10.U	10.U	10.U	10.U	10.U	10.U	10.U
Naphthalene	10.U	190.	10.U	10.U	10.U	10.U	10.U	10.U
4-Chloroaniline	10.U	10.U	10.U	10.U	10.U	10.U	10.U	10.U
Hexachlorobutadiene	10.U	10.U	10.U	10.U	10.U	10.U	10.U	10.U
4-Chloro-3-methylphenol	10.U	10.U	10.U	10.U	10.U	10.U	10.U	10.U
2-Methylnaphthalene	10.U	49.	10.U	10.U	10.U	10.U	10.U	10.U
Hexachlorocyclopentadiene	10.U	10.U	10.U	10.U	10.U	10.U	10.U	10.U
2,4,6-Trichlorophenol	10.U	10.U	10.U	10.U	10.U	10.U	10.U	10.U
2,4,5-Trichlorophenol	50.U	50.U	50.U	50.U	50.U	50.U	50.U	50.U
2-Chloronaphthalene	10.U	10.U	10.U	10.U	10.U	10.U	10.U	10.U
2-Nitroaniline	50.U	50.U	50.U	50.U	50.U	50.U	50.U	50.U
Dimethylphthalate	10.U	10.U	10.U	10.U	10.U	10.U	10.U	10.U
Acenaphthylene	10.U	10.U	10.U	10.U	10.U	10.U	10.U	10.U
2,6-Dinitrotoluene	10.U	10.U	10.U	10.U	10.U	10.U	10.U	10.U

PROJECT Camp Lejeune
 PREPARED BY Judy Yuma
 DATE April 1991
 CHECKED BY Ed King
 DATE 5/6/91

APPENDIX

CAMP LEJEUNE - HP1A
SEMI-VOLATILE ORGANIC COMPOUNDS IN GROUNDWATER (SHALLOW WELLS)
Concentration in ug/l

CHART = HPSV2B

wp8c\hp-sv.wr1 (2-B)

COMPOUND	HPGW8	HPGW9-1	HPGW10	HPGW11	HPGW12	HPGW12D (GWDUP2)	HPGW13	HPGW14
3-Nitroaniline	50.U	50.U	50.U	50.U	50.U	50.U	50.U	50.U
Acenaphthene	10.U	10.U	10.U	10.U	10.U	10.U	10.U	10.U
2,4-Dinitrophenol	50.U	50.U	50.U	50.U	50.U	50.U	50.U	50.U
4-Nitrophenol	50.U	50.U	50.U	50.U	50.U	50.U	50.U	50.U
Dibenzofuran	10.U	10.U	10.U	10.U	10.U	10.U	10.U	10.U
2,4-Dinitrotoluene	10.U	10.U	10.U	10.U	10.U	10.U	10.U	10.U
Diethylphthalate	10.U	10.U	10.U	10.U	10.U	10.U	10.U	10.U
4-Chlorophenyl-phenylether	10.U	10.U	10.U	10.U	10.U	10.U	10.U	10.U
Fluorene	10.U	10.U	10.U	10.U	10.U	10.U	10.U	10.U
4-Nitroaniline	50.U	50.U	50.U	50.U	50.U	50.U	50.U	50.U
4,6-Dinitro-2-methylphenol	50.U	50.U	50.U	50.U	50.U	50.U	50.U	50.U
N-Nitrosodiphenylamine	10.U	10.U	10.U	10.U	10.U	10.U	10.U	10.U
4-Bromophenyl-phenylether	10.U	10.U	10.U	10.U	10.U	10.U	10.U	10.U
Hexachlorobenzene	10.U	10.U	10.U	10.U	10.U	10.U	10.U	10.U
Pentachlorophenol	50.U	50.U	50.U	50.U	50.U	50.U	50.U	50.U
Phenanthrene	10.U	10.U	10.U	10.U	10.U	10.U	10.U	10.U
Anthracene	10.U	10.U	10.U	10.U	10.U	10.U	10.U	10.U
Di-n-butylphthalate	10.U	10.U	10.U	10.U	10.U	10.U	10.U	10.U
Fluoranthene	10.U	10.U	10.U	10.U	10.U	10.U	10.U	10.U
Pyrene	10.U	10.U	10.U	10.U	10.U	10.U	10.U	10.U
Butylbenzylphthalate	10.U	10.U	10.U	10.U	10.U	10.U	10.U	10.U
3,3'-Dichlorobenzidine	20.U	20.U	20.U	20.U	20.U	20.U	20.U	20.U
Benzo(a)anthracene	10.U	10.U	10.U	10.U	10.U	10.U	10.U	10.U
Chrysene	10.U	10.U	10.U	10.U	10.U	10.U	10.U	10.U
bis(2-Ethylhexyl)phthalate	2.U	10.U	10.U	10.U	10.U	10.U	10.U	10.U
Di-n-octylphthalate	10.U	10.U	10.U	10.U	10.U	10.U	10.U	10.U
Benzo(b)fluoranthene	10.U	10.U	10.U	10.U	10.U	10.U	10.U	10.U
Benzo(k)fluoranthene	10.U	10.U	10.U	10.U	10.U	10.U	10.U	10.U
Benzo(a)pyrene	10.U	10.U	10.U	10.U	10.U	10.U	10.U	10.U
Indeno(1,2,3-cd)pyrene	10.U	10.U	10.U	10.U	10.U	10.U	10.U	10.U
Dibenz(a,h)anthracene	10.U	10.U	10.U	10.U	10.U	10.U	10.U	10.U
Benzo(g,h,i)perylene	10.U	10.U	10.U	10.U	10.U	10.U	10.U	10.U

PROJECT Camp Lejeune
 PREPARED BY Judy Guma
 DATE April 1991
 CHECKED BY EL Kuyper
 DATE 5/6/91
 COMMENTS _____

CAMP LEJEUNE - HP1A
SEMI-VOLATILE ORGANIC COMPOUNDS IN GROUNDWATER (SHALLOW WELLS)
Concentration in ug/l

CHART = HPSV4A

wp8c\hp-sv.wr1 (4-A)

COMPOUND	HPG24-1	HPGW25	HPGW26	HPGW26D (GWDUP8)	HPGW29	21GW1	22GW1	22GW2
Phenol	10.U	10.U	10.U	10.U	10.U	10.U	10.U	10.U
bis(2-Chloroethyl)ether	10.U	10.U	10.U	10.U	10.U	10.U	10.U	10.U
2-Chlorophenol	10.U	10.U	10.U	10.U	10.U	10.U	10.U	10.U
1,3-Dichlorobenzene	10.U	10.U	10.U	10.U	10.U	10.U	10.U	10.U
1,4-Dichlorobenzene	10.U	10.U	10.U	10.U	10.U	10.U	10.U	10.U
Benzyl Alcohol	10.U	10.U	10.U	10.U	10.U	10.U	10.U	10.U
1,2-Dichlorobenzene	10.U	10.U	10.U	10.U	10.U	10.U	10.U	10.U
2-Methylphenol	10.U	10.U	10.U	10.U	10.U	10.U	10.U	10.U
bis(2-Chloroisopropyl)ether	10.U	10.U	10.U	10.U	10.U	10.U	10.U	10.U
4-Methylphenol	10.U	10.U	10.U	10.U	10.U	10.U	10.U	10.U
N-Nitroso-di-n-propylamine	10.U	10.U	10.U	10.U	10.U	10.U	10.U	10.U
Hexachloroethane	10.U	10.U	10.U	10.U	10.U	10.U	10.U	10.U
Nitrobenzene	10.U	10.U	10.U	10.U	10.U	10.U	10.U	10.U
Isophorone	10.U	10.U	10.U	10.U	10.U	10.U	10.U	10.U
2-Nitrophenol	10.U	10.U	10.U	10.U	10.U	10.U	10.U	10.U
2,4-Dimethylphenol	10.U	10.U	10.U	10.U	10.U	10.U	10.U	10.U
Benzoic acid	50.U	50.U	50.U	50.U	50.U	50.U	50.U	50.U
bis (2-Chloroethoxy) methane	10.U	10.U	10.U	10.U	10.U	10.U	10.U	10.U
2,4-Dichlorophenol	10.U	10.U	10.U	10.U	10.U	10.U	10.U	10.U
1,2,4-Trichlorobenzene	10.U	10.U	10.U	10.U	10.U	10.U	10.U	10.U
Naphthalene	130.	10.U	10.U	10.U	10.U	10.U	230.	10.U
4-Chloroaniline	10.U	10.U	10.U	10.U	10.U	10.U	10.U	10.U
Hexachlorobutadiene	10.U	10.U	10.U	10.U	10.U	10.U	10.U	10.U
4-Chloro-3-methylphenol	10.U	10.U	10.U	10.U	10.U	10.U	10.U	10.U
2-Methylnaphthalene	3.J	10.U	10.U	10.U	10.U	10.U	28.	10.U
Hexachlorocyclopentadiene	10.U	10.U	10.U	10.U	10.U	10.U	10.U	10.U
2,4,6-Trichlorophenol	10.U	10.U	10.U	10.U	10.U	10.U	10.U	10.U
2,4,5-Trichlorophenol	50.U	50.U	50.U	50.U	50.U	50.U	50.U	50.U
2-Chloronaphthalene	10.U	10.U	10.U	10.U	10.U	10.U	10.U	10.U
2-Nitroaniline	50.U	50.U	50.U	50.U	50.U	50.U	50.U	50.U
Dimethylphthalate	10.U	10.U	10.U	10.U	10.U	10.U	10.U	10.U
Acenaphthylene	10.U	10.U	10.U	10.U	10.U	10.U	10.U	10.U
2,6-Dinitrotoluene	10.U	10.U	10.U	10.U	10.U	10.U	10.U	10.U

PROJECT Camp Lejeune
 PREPARED BY Deedee Guma
 DATE April 1991
 CHECKED BY EL [Signature]
 DATE 5/16/91

COMMENTS

CAMP LEJEUNE - HPIA
SEMI-VOLATILE ORGANIC COMPOUNDS IN GROUNDWATER (SHALLOW WELLS)
Concentration in ug/l

CHART = HPSV4B

wp8c\hp-sv.wr1 (4-B)

COMPOUND	HPG24-1	HPGW25	HPGW26	HPGW26D (GWDUP8)	HPGW29	21GW1	22GW1	22GW2
3-Nitroaniline	50.U	50.U	50.U	50.U	50.U	50.U	50.U	50.U
Acenaphthene	6.J	10.U	10.U	10.U	10.U	10.U	10.U	10.U
2,4-Dinitrophenol	50.U	50.U	50.U	50.U	50.U	50.U	50.U	50.U
4-Nitrophenol	50.U	50.U	50.U	50.U	50.U	50.U	50.U	50.U
Dibenzofuran	10.U	10.U	10.U	10.U	10.U	10.U	10.U	10.U
2,4-Dinitrotoluene	10.U	10.U	10.U	10.U	10.U	10.U	10.U	10.U
Diethylphthalate	10.U	10.U	10.U	10.U	10.U	10.U	10.U	10.U
4-Chlorophenyl-phenylether	10.U	10.U	10.U	10.U	10.U	10.U	10.U	10.U
Fluorene	10.U	10.U	10.U	10.U	10.U	10.U	10.U	10.U
4-Nitroaniline	50.U	50.U	50.U	50.U	50.U	50.U	50.U	50.U
4,6-Dinitro-2-methylphenol	50.U	50.U	50.U	50.U	50.U	50.U	50.U	50.U
N-Nitrosodiphenylamine	10.U	10.U	10.U	10.U	10.U	10.U	10.U	10.U
4-Bromophenyl-phenylether	10.U	10.U	10.U	10.U	10.U	10.U	10.U	10.U
Hexachlorobenzene	10.U	10.U	10.U	10.U	10.U	10.U	10.U	10.U
Pentachlorophenol	50.U	50.U	50.U	50.U	50.U	50.U	50.U	50.U
Phenanthrene	10.U	10.U	10.U	10.U	10.U	10.U	10.U	10.U
Anthracene	10.U	10.U	10.U	10.U	10.U	10.U	10.U	10.U
Di-n-butylphthalate	10.U	10.U	10.U	10.U	10.U	10.U	10.U	10.U
Fluoranthene	10.U	10.U	10.U	10.U	10.U	10.U	10.U	10.U
Pyrene	10.U	10.U	10.U	10.U	10.U	10.U	10.U	10.U
Butylbenzylphthalate	10.U	10.U	10.U	10.U	10.U	10.U	10.U	10.U
3,3'-Dichlorobenzidine	20.U	20.U	20.U	20.U	20.U	20.U	20.U	20.U
Benzo(a)anthracene	10.U	10.U	10.U	10.U	10.U	10.U	10.U	10.U
Chrysene	10.U	10.U	10.U	10.U	10.U	10.U	10.U	10.U
bis(2-Ethylhexyl)phthalate	10.U	10.U	10.U	10.U	10.U	10.U	10.U	10.U
Di-n-octylphthalate	10.U	10.U	10.U	10.U	10.U	10.U	10.U	10.U
Benzo(b)fluoranthene	10.U	10.U	10.U	10.U	10.U	10.U	10.U	10.U
Benzo(k)fluoranthene	10.U	10.U	10.U	10.U	10.U	10.U	10.U	10.U
Benzo(a)pyrene	10.U	10.U	10.U	10.U	10.U	10.U	10.U	10.U
Indeno(1,2,3-cd)pyrene	10.U	10.U	10.U	10.U	10.U	10.U	10.U	10.U
Dibenz(a,h)anthracene	10.U	10.U	10.U	10.U	10.U	10.U	10.U	10.U
Benzo(g,h,i)perylene	10.U	10.U	10.U	10.U	10.U	10.U	10.U	10.U

PROJECT Camp Lejeune
PREPARED BY Shirley Quana
DATE April 1991
CHECKED BY ED King
DATE 5/6/91

COMMENTS

CAMP LEJEUNE - HPIA
 INORGANICS IN GROUNDWATER (SHALLOW WELLS)
 Concentration in ug/l

CHART = HPING1

wp8e\hp-inor.wr1 (1)

METAL/COMPOUND	HPGW1	HPGW2	HPGW3	HPGW4-1	HPGW4-1D (GWDUP5)	HPGW5	HPGW6	HPGW7
Aluminum	30600	56000	19300	97000	96800	3580	1050000	161000
Antimony	13.3U	15.6B	46.5B	21.9B	34.6B	13.3U	13.3U	22.0U
Arsenic	8.0B	24.1	15.6	15.5	19.4	1.5U	31.5	18.3
Barium	166B	84.4B	55.5B	268	273	13.6B	1960	670
Beryllium	6.0	1.7B	1.2B	6.7	6.4	0.86B	20.0	4.8B
Cadmium	4.3U	4.3U	4.3U	4.3U	4.3U	4.3U	4.3U	4.3U
Calcium	30100	46800	29800	296000	310000	80100	11200	10500
Chromium	87.0	64.3	16.7	187	195	3.6B	1590	313
Cobalt	6.0U	6.1B	8.0U	14.4B	18.2B	6.0U	51.9	17.7B
Copper	17.4B	17.3B	5.5B	35.4	39.2	4.1B	194	44.2
Iron	64100	34800	10400	100000	106000	3100	265000	65700
Lead	16.6	29.4	11.4	66.6	45.6	13.6	60.7	112
Magnesium	5590	3980B	2580B	12100	12500	11100	49700	18200
Manganese	168	77.7	53.9	425	436	162	487	136
Mercury	0.10U	0.10U	0.10U	0.10U	0.10U	0.10U	1.4	0.25
Nickel	31.3B	16.9B	12.1B	57.0	64.3	5.2U	161	50.7
Potassium	3940B	4820B	2230B	9710	9520	3930B	55300	12000
Selenium	3.4U	3.6B	3.4U	3.4U	3.4U	4.4B	3.4U	2.6B
Silver	4.7B	1.6U	1.6U	1.6U	2.4B	1.6U	2.3B	6.2U
Sodium	10900	3680B	6390	11400	11100	22400	14800	11500
Thallium	4.4U	4.4U	4.4U	4.4U	4.4U	4.4U	4.4U	1.1U
Vanadium	92.1	160	35.9B	213	222	2.4U	1610	285
Zinc	163	88.2	59.8	228	272	71.3	537	218
Cyanide	10.0U	11.2U	11.2	10.0U	10.0U	10.0U	10.0U	10.0U

CAMP LEJEUNE - HP1A
 PESTICIDES IN GROUNDWATER (SHALLOW WELLS)
 Concentration in ug/l

CHART = HPPEST1

sy\wp8b\hp-pest.wr1 (1)

PESTICIDE/PCB	HPGW1	HPGW2	HPGW3	HPGW4-1	HPGW4-1D (GWDUP5)	HPGW5	HPGW6	HPGW7
alpha-BHC	.05U	.05U	.05U	.05U	.05U	.05U	.05U	.05U
beta-BHC	.05U	.05U	.05U	.05U	.05U	.05U	.05U	.05U
delta-BHC	.05U	.05U	.05U	.05U	.05U	.05U	.05U	.05U
gamma-BHC (Lindane)	.05U	.05U	.05U	.05U	.05U	.05U	.05U	.05U
Heptachlor	.05U	.05U	.05U	.05U	.05U	.05U	.05U	.05U
Aldrin	.05U	.05U	.05U	.05U	.05U	.05U	.05U	.05U
Heptachlor epoxide	.05U	.05U	.05U	.05U	.05U	.05U	.05U	.05U
Endosulfan I	.05U	.05U	.05U	.05U	.05U	.05U	.05U	.05U
Dieldrin	.10U	.10U	.10U	.10U	.10U	.10U	.10U	.10U
4,4'-DDE	.10U	.10U	.10U	.10U	.10U	.10U	.10U	.10U
Endrin	.10U	.10U	.10U	.10U	.10U	.10U	.10U	.10U
Endosulfan II	.10U	.10U	.10U	.10U	.10U	.10U	.10U	.10U
4,4'-DDD	.10U	.10U	.10U	.10U	.10U	.10U	.10U	.10U
Endosulfan sulfate	.10U	.10U	.10U	.10U	.10U	.10U	.10U	.10U
4,4'-DDT	.10U	.10U	.10U	.10U	.10U	.10U	.10U	.10U
Methoxychlor	.50U	.50U	.50U	.50U	.50U	.50U	.50U	.50U
Endrin ketone	.10U	.10U	.10U	.10U	.10U	.10U	.10U	.10U
alpha-Chlordane	.50U	.50U	.50U	.50U	.50U	.50U	.50U	.50U
gamma-Chlordane	.50U	.50U	.50U	.50U	.50U	.50U	.50U	.50U
Toxaphene	1.0U	1.0U	1.0U	1.0U	1.0U	1.0U	1.0U	1.0U
Aroclor-1016	.50U	.50U	.50U	.50U	.50U	.50U	.50U	.50U
Aroclor-1221	.50U	.50U	.50U	.50U	.50U	.50U	.50U	.50U
Aroclor-1232	.50U	.50U	.50U	.50U	.50U	.50U	.50U	.50U
Aroclor-1242	.50U	.50U	.50U	.50U	.50U	.50U	.50U	.50U
Aroclor-1248	.50U	.50U	.50U	.50U	.50U	.50U	.50U	.50U
Aroclor-1254	1.0U	1.0U	1.0U	1.0U	1.0U	1.0U	1.0U	1.0U
Aroclor-1260	1.0U	1.0U	1.0U	1.0U	1.0U	1.0U	1.0U	1.0U

PROJECT Camp Lejeune
 PREPARED BY Glady Luna
 DATE April 1991
 CHECKED BY Ed King
 DATE 5/6/91

COMMENTS

CAMP LEJEUNE - HPIA
 PESTICIDES IN GROUNDWATER (SHALLOW WELLS)
 Concentration in ug/l

CHART = HPPEST3

sy\wp8b\hp-pest.wr1 (3)

PESTICIDE/PCB	HPGW15	HPGW16	HPGW17-1	HPGW19	HPGW20	HPGW21	HPGW22	HPGW23
alpha-BHC	.05U	.05U	.05U	.05U	.05U	.05U	.05U	.05U
beta-BHC	.05U	.05U	.05U	.05U	.05U	.05U	.05U	.05U
delta-BHC	.05U	.05U	.05U	.05U	.05U	.05U	.05U	.05U
gamma-BHC (Lindane)	.05U	.05U	.05U	.05U	.05U	.05U	.05U	.05U
Heptachlor	.05U	.05U	.05U	.05U	.05U	.05U	.05U	.05U
Aldrin	.05U	.05U	.05U	.05U	.05U	.05U	.05U	.05U
Heptachlor epoxide	.05U	.05U	.05U	.05U	.05U	.05U	.05U	.05U
Endosulfan I	.05U	.05U	.05U	.05U	.05U	.05U	.05U	.05U
Dieldrin	.10U	.10U	.11	.10U	.10U	.10U	.10U	.10U
4,4'-DDE	.10U	.10U	.10U	.10U	.10U	.10U	.10U	.10U
Endrin	.10U	.10U	.10U	.10U	.10U	.10U	.10U	.10U
Endosulfan II	.10U	.10U	.10U	.10U	.10U	.10U	.10U	.10U
4,4'-DDD	.10U	.10U	.10U	.10U	.10U	.10U	.10U	.10U
Endosulfan sulfate	.10U	.10U	.10U	.10U	.10U	.10U	.10U	.10U
4,4'-DDT	.10U	.10U	.10U	.10U	.10U	.10U	.10U	.10U
Methoxychlor	.50U	.50U	.50U	.50U	.50U	.50U	.50U	.50U
Endrin ketone	.10U	.10U	.10U	.10U	.10U	.10U	.10U	.10U
alpha-Chlordane	.50U	.50U	.50U	.50U	.50U	.50U	.50U	.50U
gamma-Chlordane	.50U	.50U	.50U	.50U	.50U	.50U	.50U	.50U
Toxaphene	1.0U	1.0U	1.0U	1.0U	1.0U	1.0U	1.0U	1.0U
Aroclor-1016	.50U	.50U	.50U	.50U	.50U	.50U	.50U	.50U
Aroclor-1221	.50U	.50U	.50U	.50U	.50U	.50U	.50U	.50U
Aroclor-1232	.50U	.50U	.50U	.50U	.50U	.50U	.50U	.50U
Aroclor-1242	.50U	.50U	.50U	.50U	.50U	.50U	.50U	.50U
Aroclor-1248	.50U	.50U	.50U	.50U	.50U	.50U	.50U	.50U
Aroclor-1254	1.0U	1.0U	1.0U	1.0U	1.0U	1.0U	1.0U	1.0U
Aroclor-1260	1.0U	1.0U	1.0U	1.0U	1.0U	1.0U	1.0U	1.0U

PROJECT	<i>Camp Lejeune</i>	PREPARED BY	<i>Judy Suma</i>	DATE	<i>April 1991</i>
CHECKED BY	<i>Ed King</i>	DATE	<i>5/6/91</i>	COMMENTS	

CAMP LEJEUNE - HPIA
 PESTICIDES IN GROUNDWATER (SHALLOW WELLS)
 Concentration in ug/l

CHART = HPPEST4

sy\wp8b\hp-pest.wr1 (4)

PESTICIDE/PCB	HPGW24-1	HPGW25	HPGW26	HPGW26D (GWDUP8)	HPGW29	21GW1	22GW1	22GW2
alpha-BHC	.05U	.05U	.05U	.05U	.05U	.05U	.05U	.05U
beta-BHC	.05U	.05U	.05U	.05U	.05U	.05U	.05U	.05U
delta-BHC	.05U	.05U	.05U	.05U	.05U	.05U	.05U	.05U
gamma-BHC (Lindane)	.05U	.05U	.05U	.05U	.05U	.05U	.05U	.05U
Heptachlor	.05U	.05U	.05U	.05U	.05U	.05U	.05U	.05U
Aldrin	.05U	.05U	.05U	.05U	.05U	.05U	.05U	.05U
Heptachlor epoxide	.05U	.05U	.05U	.05U	.05U	.05U	.05U	.05U
Endosulfan I	.05U	.05U	.05U	.05U	.05U	.05U	.05U	.05U
Dieldrin	.10U	.10U	.10U	.10U	.10U	.10U	.10U	.10U
4,4'-DDE	.10U	.10U	.10U	.10U	.10U	.10U	.10U	.10U
Endrin	.10U	.10U	.10U	.10U	.10U	.10U	.10U	.10U
Endosulfan II	.10U	.10U	.10U	.10U	.10U	.10U	.10U	.10U
4,4'-DDD	.10U	.10U	.10U	.10U	.10U	.10U	.10U	.10U
Endosulfan sulfate	.10U	.10U	.10U	.10U	.10U	.10U	.10U	.10U
4,4'-DDT	.10U	.10U	.10U	.10U	.10U	.10U	.10U	.10U
Methoxychlor	.50U	.50U	.50U	.50U	.50U	.50U	.50U	.50U
Endrin ketone	.10U	.10U	.10U	.10U	.10U	.10U	.10U	.10U
alpha-Chlordane	.50U	.50U	.50U	.50U	.50U	.50U	.50U	.50U
gamma-Chlordane	.50U	.50U	.50U	.50U	.50U	.50U	.50U	.50U
Toxaphene	1.0U	1.0U	1.0U	1.0U	1.0U	1.0U	1.0U	1.0U
Aroclor-1016	.50U	.50U	.50U	.50U	.50U	.50U	.50U	.50U
Aroclor-1221	.50U	.50U	.50U	.50U	.50U	.50U	.50U	.50U
Aroclor-1232	.50U	.50U	.50U	.50U	.50U	.50U	.50U	.50U
Aroclor-1242	.50U	.50U	.50U	.50U	.50U	.50U	.50U	.50U
Aroclor-1248	.50U	.50U	.50U	.50U	.50U	.50U	.50U	.50U
Aroclor-1254	1.0U	1.0U	1.0U	1.0U	1.0U	1.0U	1.0U	1.0U
Aroclor-1260	1.0U	1.0U	1.0U	1.0U	1.0U	1.0U	1.0U	1.0U

PROJECT Camp Lejeune
 PREPARED BY Judy Anna
 DATE April 1991
 CHECKED BY E. L. King
 DATE 5/6/91
 COMMENTS

APPENDIX K

**CHARACTERIZATION INVESTIGATION
INTERMEDIATE MONITOR WELLS
ANALYTICAL RESULTS**

PROJECT NUMBER 86447 0406
 FIELD GROUP LJHP-4

PROJECT NAME NAVY - LEJEUNE HP4
 LAB COORDINATOR JEFF SHAMIS

SAMPLE ID/#

PARAMETERS	STORET #	HPGW9-2 LJHP-4	HPGW17-2 LJHP-4	HPGW24-2 LJHP-4
UNITS	METHOD	1	3	5
DATE		08/06/87	08/05/87	08/06/87
TIME		11:30	16:13	13:15
BENZENE	34030	<1.0	<1.0	<1.0
UG/L	GMS			
BROMODICHLOROMETHANE	32101	<2.2	<2.2	<2.2
UG/L	GMS			
BROMOFORM	32104	<4.7	<4.7	<4.7
UG/L	GMS			
BROMOMETHANE	34413	<5.8	<5.8	<5.8
UG/L	GMS			
CARBON TETRACHLORIDE	32102	<2.8	<2.8	<2.8
UG/L	GMS			
CHLOROBENZENE	34301	<6.0	<6.0	<6.0
UG/L	GMS			
CHLOROETHANE	34311	<8.2	<8.2	<8.2
UG/L	GMS			
2-CHLOROETHYL VINYL	34576	<15	<15	<15
ETHER	UG/L	GMS		
CHLOROFORM	32106	<1.6	<1.6	<1.6
UG/L	GMS			
CHLOROMETHANE	34418	<4.3	<4.3	<4.3
UG/L	GMS			
DIBROMOCHLOROMETHANE	32105	<3.1	<3.1	<3.1
UG/L	GMS			
1,1-DICHLOROETHANE	34496	<4.7	<4.7	<4.7
UG/L	GMS			
1,2-DICHLOROETHANE	34531	<2.8	<2.8	<2.8
UG/L	GMS			
1,1-DICHLOROETHYLENE	34501	<2.8	<2.8	<2.8
UG/L	GMS			
TRANS-1,2-DICHLORO	34546	<1.6	<1.6	<1.6
ETHENE	UG/L	GMS		
1,2-DICHLOROPROPANE	34541	<6.0	<6.0	<6.0
UG/L	GMS			
CIS-1,3-DICHLORO	34704	<5.0	<5.0	<5.0
PROPENE	UG/L	GMS		
TRANS-1,3-DICHLORO	34699	<6.4	<6.4	<6.4
PROPENE	UG/L	GMS		
ETHYLBENZENE	34371	<7.2	<7.2	<7.2
UG/L	GMS			
METHYLENE CHLORIDE	34423	<50	<50	<50
UG/L	GMS			

PROJECT NUMBER 86447 0406
 FIELD GROUP LJHP-4

PROJECT NAME NAVY - LEJEUNE HP4
 LAB COORDINATOR JEFF SHAMIS

SAMPLE ID/#

PARAMETERS	STORET #	HPGW9-2	HPGW17-2	HPGW24-2
UNITS	METHOD	LJHP-4	LJHP-4	LJHP-4
		1	3	5
DATE		08/06/87	08/05/87	08/06/87
TIME		11:30	16:13	13:15
1,1,2,2-TETRACHLOROETHANE	34516	<4.1	<4.1	<4.1
UG/L	GMS			
TETRACHLOROETHENE	34475	<3.0	<3.0	<3.0
UG/L	GMS			
TOLUENE	34010	<6.0	<6.0	<6.0
UG/L	GMS			
1,1,1-TRICHL'ETHANE	34506	<3.8	<3.8	<3.8
UG/L	GMS			
1,1,2-TRICHL'ETHANE	34511	<5.0	<5.0	<5.0
UG/L	GMS			
TRICHLOROETHENE	39180	<1.0	<1.0	<1.0
UG/L	GMS			
TRICHLOROFLUORO-METHANE	34488	<3.2	<3.2	<3.2
UG/L	GMS			
VINYL CHLORIDE	39175	<1.0	<1.0	<1.0
UG/L	GMS			
ACROLEIN	34210	<100	<100	<100
UG/L	GMS			
ACRYLONITRILE	34215	<100	<100	<100
UG/L	GMS			
DICHLORODIFLUORO-METHANE	34668	<10	<10	<10
UG/L	GMS			
M-XYLENE	98553	<12	<12	<12
UG/L	GMS			
O-AND/OR-P XYLENE	98554	<12	<12	<12
UG/L	GMS			
METHYL ETHYL KETONE	81595	<48	<48	<48
UG/L	GMS			
METHYL ISOBUT'KETONE	81596	<12	<12	<12
UG/L	GMS			

APPENDIX L

**SUPPLEMENTAL CHARACTERIZATION INVESTIGATION
INTERMEDIATE MONITOR WELLS
ANALYTICAL RESULTS**

CAMP LEJEUNE - HP1A
VOLATILE ORGANIC COMPOUNDS IN GROUNDWATER (INTERMEDIATE WELLS)
Concentration in ug/l

CHART = HPVOL5

wp8b\hp-vol.wr1 (5)

COMPOUND	HPGW4-2	HPGW9-2	HPGW17-2	HPGW24-2	HPGW30-2	HPGW30-2D (GWDUP4)
Chloromethane	10.U	10.U	10.U	10.U	10.U	10.U
Bromomethane	10.U	10.U	10.U	10.U	10.U	10.U
Vinyl Chloride	10.U	10.U	10.U	10.U	12.	12.
Chloroethane	10.U	10.U	10.U	10.U	10.U	10.U
Methylene Chloride	1.J	5.U	5.U	5.U	5.U	5.U
Acetone	19.	10.U	10.U	10.U	7.J	10.U
Carbon Disulfide	10.	22.	14.	9.	5.U	5.U
1,1-Dichloroethene	5.U	5.U	5.U	5.U	5.U	5.U
1,1-Dichloroethane	5.U	5.U	5.U	5.U	5.U	5.U
1,2-Dichloroethene (total)	5.U	11.	1.J	5.U	12.	11.
Chloroform	5.U	5.U	5.U	5.U	5.U	5.U
1,2-Dichloroethane	5.U	5.U	5.U	5.U	5.U	5.U
2-Butanone	10.U	10.U	10.U	10.U	10.U	10.U
1,1,1-Trichloroethane	5.U	5.U	5.U	5.U	5.U	5.U
Carbon Tetrachloride	5.U	5.U	5.U	5.U	5.U	5.U
Vinyl Acetate	10.U	10.U	10.U	10.U	10.U	10.U
Bromodichloromethane	5.U	5.U	5.U	5.U	5.U	5.U
1,2-Dichloropropane	5.U	5.U	5.U	5.U	5.U	5.U
cis-1,3-Dichloropropene	5.U	5.U	5.U	5.U	5.U	5.U
Trichloroethene	5.U	5.U	5.U	5.U	5.U	5.U
Dibromochloromethane	5.U	5.U	5.U	5.U	5.U	5.U
1,1,2-Trichloroethane	5.U	5.U	5.U	5.U	5.U	5.U
Benzene	5.U	5.U	3.J	5.U	2.J	2.J
trans-1,3-Dichloropropene	5.U	5.U	5.U	5.U	5.U	5.U
Bromoform	5.U	5.U	5.U	5.U	5.U	5.U
4-Methyl-2-Pentanone	10.U	10.U	10.U	10.U	10.U	10.U
2-Hexanone	10.U	10.U	10.U	10.U	10.U	10.U
Tetrachloroethene	5.U	5.U	5.U	5.U	5.U	5.U
1,1,2,2-Tetrachloroethane	5.U	5.U	5.U	5.U	5.U	5.U
Toluene	1.J	5.U	5.U	5.U	2.J	2.J
Chlorobenzene	5.U	5.U	5.U	5.U	5.U	5.U
Ethylbenzene	5.U	5.U	5.U	5.U	.7J	.6J
Styrene	5.U	5.U	5.U	5.U	5.U	5.U
Xylene (total)	5.U	5.U	5.U	5.U	2.J	1.J

PROJECT Camp Lejeune
 PREPARED BY Paul M. Pinkney
 DATE April 1991
 CHECKED BY Judy Yuma
 DATE 5-10-91

CAMP LEJEUNE - HPIA
 VOLATILE ORGANIC COMPOUNDS IN GROUNDWATER (INTERMEDIATE WELLS)
 Concentration in ug/L

CHART = HPVOL6

wp8b\hp-vol.wr1 (6)

COMPOUND	HPGW31-2	HPGW32-2
Chloromethane	10.U	10.U
Bromomethane	10.U	10.U
Vinyl Chloride	10.U	10.U
Chloroethane	10.U	10.U
Methylene Chloride	5.U	5.U
Acetone	6.BJ	19.
Carbon Disulfide	1.J	5.J
1,1-Dichloroethene	5.U	5.U
1,1-Dichloroethane	5.U	5.U
1,2-Dichloroethene (total)	5.U	5.U
Chloroform	5.U	5.U
1,2-Dichloroethane	5.U	5.U
2-Butanone	10.U	10.U
1,1,1-Trichloroethane	5.U	5.U
Carbon Tetrachloride	5.U	5.U
Vinyl Acetate	10.U	10.U
Bromodichloromethane	5.U	5.U
1,2-Dichloropropane	5.U	5.U
cis-1,3-Dichloropropene	5.U	5.U
Trichloroethene	5.U	5.U
Dibromochloromethane	5.U	5.U
1,1,2-Trichloroethane	5.U	5.U
Benzene	5.U	27.
trans-1,3-Dichloropropene	5.U	5.U
Bromoform	5.U	5.U
4-Methyl-2-Pentanone	10.U	10.U
2-Hexanone	10.U	10.U
Tetrachloroethene	5.U	5.U
1,1,2,2-Tetrachloroethane	5.U	5.U
Toluene	5.U	31.
Chlorobenzene	5.U	5.U
Ethylbenzene	5.U	2.J
Styrene	5.U	5.U
Xylene (total)	1.J	8.

PROJECT	<i>Camp Lejeune</i>
PREPARED BY	<i>Paul M. Kinberg</i>
DATE	<i>April 1991</i>
CHECKED BY	<i>Judy Guma</i>
DATE	<i>5-7-91</i>

CAMP LEJEUNE - HPIA
SEMI-VOLATILE ORGANIC COMPOUNDS IN GROUNDWATER (INTERMEDIATE WELLS)
Concentration in ug/l

CHART = HPSV5A

wp8c\hp-sv.wr1 (5-A)

COMPOUND	HPGW4-2	HPGW9-2	HPGW17-2	HPGW24-2	HPGW30-2	HPGW30-2D (GMDUP4)
Phenol	10.U	10.U	10.U	10.U	10.U	10.U
bis(2-Chloroethyl)ether	10.U	10.U	10.U	10.U	10.U	10.U
2-Chlorophenol	10.U	10.U	10.U	10.U	10.U	10.U
1,3-Dichlorobenzene	10.U	10.U	10.U	10.U	10.U	10.U
1,4-Dichlorobenzene	10.U	10.U	10.U	10.U	10.U	10.U
Benzyl Alcohol	10.U	10.U	10.U	10.U	10.U	10.U
1,2-Dichlorobenzene	10.U	10.U	10.U	10.U	10.U	10.U
2-Methylphenol	10.U	10.U	10.U	10.U	10.U	10.U
bis(2-Chloroisopropyl)ether	10.U	10.U	10.U	10.U	10.U	10.U
4-Methylphenol	10.U	10.U	10.U	10.U	10.U	10.U
N-Nitroso-di-n-propylamine	10.U	10.U	10.U	10.U	10.U	10.U
Hexachloroethane	10.U	10.U	10.U	10.U	10.U	10.U
Nitrobenzene	10.U	10.U	10.U	10.U	10.U	10.U
Isophorone	10.U	10.U	10.U	10.U	10.U	10.U
2-Nitrophenol	10.U	10.U	10.U	10.U	10.U	10.U
2,4-Dimethylphenol	10.U	10.U	10.U	10.U	10.U	10.U
Benzoic acid	50.U	50.U	50.U	50.U	48.U	50.U
bis(2-Chloroethoxy)methane	10.U	10.U	10.U	10.U	10.U	10.U
2,4-Dichlorophenol	10.U	10.U	10.U	10.U	10.U	10.U
1,2,4-Trichlorobenzene	10.U	10.U	10.U	10.U	10.U	10.U
Naphthalene	10.U	10.U	56.	10.U	270.	88.
4-Chloroaniline	10.U	10.U	10.U	10.U	10.U	10.U
Hexachlorobutadiene	10.U	10.U	10.U	10.U	10.U	10.U
4-Chloro-3-methylphenol	10.U	10.U	10.U	10.U	10.U	10.U
2-Methylnaphthalene	10.U	10.U	2.J	10.U	9.J	10.U
Hexachlorocyclopentadiene	10.U	10.U	10.U	10.U	10.U	10.U
2,4,6-Trichlorophenol	10.U	10.U	10.U	10.U	10.U	10.U
2,4,5-Trichlorophenol	50.U	50.U	50.U	50.U	48.U	50.U
2-Chloronaphthalene	10.U	10.U	10.U	10.U	10.U	10.U
2-Nitroaniline	50.U	50.U	50.U	50.U	48.U	50.U
Dimethylphthalate	10.U	10.U	10.U	10.U	10.U	10.U
Acenaphthylene	10.U	10.U	10.U	10.U	10.U	10.U
2,6-Dinitrotoluene	10.U	10.U	10.U	10.U	10.U	10.U

PROJECT Camp Lejeune
 PREPARED BY Julie Gunn
 DATE April 1991
 CHECKED BY E. R. Knight
 DATE 5/13/91

COMMENTS

CAMP LEJEUNE - HPIA
SEMI-VOLATILE ORGANIC COMPOUNDS IN GROUNDWATER (INTERMEDIATE WELLS)
Concentration in ug/l

CHART = HPSV5B

wp8c\hp-sv.wr1 (5-B)

COMPOUND	HPGW4-2	HPGW9-2	HPGW17-2	HPGW24-2	HPGW30-2	HPGW30-2D (GWDUP4)
3-Nitroaniline	50.U	50.U	50.U	50.U	48.U	50.U
Acenaphthene	10.U	10.U	5.J	10.U	1.J	10.U
2,4-Dinitrophenol	50.U	50.U	50.U	50.U	48.U	50.U
4-Nitrophenol	50.U	50.U	50.U	50.U	48.U	50.U
Dibenzofuran	10.U	10.U	10.U	10.U	10.U	10.U
2,4-Dinitrotoluene	10.U	10.U	10.U	10.U	10.U	10.U
Diethylphthalate	10.U	10.U	10.U	10.U	10.U	10.U
4-Chlorophenyl-phenylether	10.U	10.U	10.U	10.U	10.U	10.U
Fluorene	10.U	10.U	10.U	10.U	10.U	10.U
4-Nitroaniline	50.U	50.U	50.U	50.U	48.U	50.U
4,6-Dinitro-2-methylphenol	50.U	50.U	50.U	50.U	48.U	50.U
N-Nitrosodiphenylamine	10.U	10.U	10.U	10.U	10.U	10.U
4-Bromophenyl-phenylether	10.U	10.U	10.U	10.U	10.U	10.U
Hexachlorobenzene	10.U	10.U	10.U	10.U	10.U	10.U
Pentachlorophenol	50.U	50.U	50.U	50.U	48.U	50.U
Phenanthrene	10.U	10.U	10.U	10.U	10.U	10.U
Anthracene	10.U	10.U	10.U	10.U	10.U	10.U
Di-n-butylphthalate	10.U	10.U	10.U	10.U	10.U	10.U
Fluoranthene	10.U	10.U	10.U	10.U	10.U	10.U
Pyrene	10.U	10.U	10.U	10.U	10.U	10.U
Butylbenzylphthalate	10.U	10.U	10.U	10.U	10.U	10.U
3,3'-Dichlorobenzidine	20.U	20.U	20.U	20.U	20.U	20.U
Benzo(a)anthracene	10.U	10.U	10.U	10.U	10.U	10.U
Chrysene	10.U	10.U	10.U	10.U	10.U	10.U
bis(2-Ethylhexyl)phthalate	10.U	2.J	1.J	2.J	10.U	10.U
Di-n-octylphthalate	10.U	10.U	10.U	10.U	10.U	10.U
Benzo(b)fluoranthene	10.U	10.U	10.U	10.U	10.U	10.U
Benzo(k)fluoranthene	10.U	10.U	10.U	10.U	10.U	10.U
Benzo(a)pyrene	10.U	10.U	10.U	10.U	10.U	10.U
Indeno(1,2,3-cd)pyrene	10.U	10.U	10.U	10.U	10.U	10.U
Dibenz(a,h)anthracene	10.U	10.U	10.U	10.U	10.U	10.U
Benzo(g,h,i)perylene	10.U	10.U	10.U	10.U	10.U	10.U

CAMP LEJEUNE - HPIA
 SEMI-VOLATILE ORGANIC COMPOUNDS IN GROUNDWATER (INTERMEDIATE WELLS)
 Concentration in ug/l

CHART = HPSV6A

wp8c\hp-sv.wr1 (6-A)

COMPOUND	HPGW31-2	HPGW32-2
Phenol	10.U	10.U
bis(2-Chloroethyl)ether	10.U	10.U
2-Chlorophenol	10.U	10.U
1,3-Dichlorobenzene	10.U	10.U
1,4-Dichlorobenzene	10.U	10.U
Benzyl Alcohol	10.U	10.U
1,2-Dichlorobenzene	10.U	10.U
2-Methylphenol	10.U	10.U
bis(2-Chloroisopropyl)ether	10.U	10.U
4-Methylphenol	10.U	10.U
N-Nitroso-di-n-propylamine	10.U	10.U
Hexachloroethane	10.U	10.U
Nitrobenzene	10.U	10.U
Isophorone	10.U	10.U
2-Nitrophenol	10.U	10.U
2,4-Dimethylphenol	10.U	10.U
Benzoic acid	50.U	50.U
bis(2-Chloroethoxy)methane	10.U	10.U
2,4-Dichlorophenol	10.U	10.U
1,2,4-Trichlorobenzene	10.U	10.U
Naphthalene	10.U	10.U
4-Chloroaniline	10.U	10.U
Hexachlorobutadiene	10.U	10.U
4-Chloro-3-methylphenol	10.U	10.U
2-Methylnaphthalene	10.U	10.U
Hexachlorocyclopentadiene	10.U	10.U
2,4,6-Trichlorophenol	10.U	10.U
2,4,5-Trichlorophenol	50.U	50.U
2-Chloronaphthalene	10.U	10.U
2-Nitroaniline	50.U	50.U
Dimethylphthalate	10.U	10.U
Acenaphthylene	10.U	10.U
2,6-Dinitrotoluene	10.U	10.U

PROJECT Camp Lejeune
 PREPARED BY Judy Herma
 DATE April 1991
 CHECKED BY E.C. King
 DATE 5/10/91
 COMMENTS _____

CAMP LEJEUNE - HPIA
SEMI-VOLATILE ORGANIC COMPOUNDS IN GROUNDWATER (INTERMEDIATE WELLS)
Concentration in ug/l

CHART = HPSV6B

wp8c\hp-sv.wr1 (6-B)

COMPOUND	HPGW31-2	HPGW32-2
3-Nitroaniline	50.U	50.U
Acenaphthene	10.U	10.U
2,4-Dinitrophenol	50.U	50.U
4-Nitrophenol	50.U	50.U
Dibenzofuran	10.U	10.U
2,4-Dinitrotoluene	10.U	10.U
Diethylphthalate	10.U	10.U
4-Chlorophenyl-phenylether	10.U	10.U
Fluorene	10.U	10.U
4-Nitroaniline	50.U	50.U
4,6-Dinitro-2-methylphenol	50.U	50.U
N-Nitrosodiphenylamine	10.U	10.U
4-Bromophenyl-phenylether	10.U	10.U
Hexachlorobenzene	10.U	10.U
Pentachlorophenol	50.U	50.U
Phenanthrene	10.U	10.U
Anthracene	10.U	10.U
Di-n-butylphthalate	10.U	10.U
Fluoranthene	10.U	10.U
Pyrene	10.U	10.U
Butylbenzylphthalate	10.U	10.U
3,3'-Dichlorobenzidine	20.U	20.U
Benzo(a)anthracene	10.U	10.U
Chrysene	10.U	10.U
bis(2-Ethylhexyl)phthalate	10.U	10.U
Di-n-octylphthalate	10.U	10.U
Benzo(b)fluoranthene	10.U	10.U
Benzo(k)fluoranthene	10.U	10.U
Benzo(a)pyrene	10.U	10.U
Indeno(1,2,3-cd)pyrene	10.U	10.U
Dibenz(a,h)anthracene	10.U	10.U
Benzo(g,h,i)perylene	10.U	10.U

CAMP LEJEUNE - HPIA
 INORGANICS IN GROUNDWATER (INTERMEDIATE WELLS)
 Concentration in ug/l

CHART = HPIG5

wp8e\hp-inor.wr1 (5)

METAL/COMPOUND	HPGW4-2	HPGW9-2	HPGW17-2	HPGW24-2	HPGW30-2	HPGW30-2D (GWDUP4)
Aluminum	230	170B	2760	2330	1860	1830
Antimony	13.3U	22.0U	22.0U	22.0U	13.3U	13.3U
Arsenic	1.5U	1.8U	1.8U	1.8U	1.5U	1.5U
Barium	33.6B	24.2B	82.1B	22.9B	28.7B	19.0B
Beryllium	1.5U	2.1	2.1	2.1U	0.61B	0.61B
Cadmium	4.3U	4.3U	4.3U	4.3U	4.3U	4.3U
Calcium	20100	101000	190000	105000	138000	132000
Chromium	7.6B	5.2U	14.6	11.0	4.9B	7.0B
Cobalt	6.0U	6.4U	6.4U	6.4U	6.0U	6.0U
Copper	7.3B	9.3B	9.2B	8.3B	7.3B	11.2B
Iron	354	461	2920	3460	4950	4850
Lead	27.1	2.7B	8.9	13.5	5.0	6.2
Magnesium	932B	2480B	3290B	1720B	2350B	2260B
Manganese	9.2B	9.3B	35.7	29.7	51.1	49.0
Mercury	0.10U	0.10U	0.10U	0.10U	0.10U	0.10U
Nickel	5.2U	11.0U	11.0U	11.0U	5.2U	5.2U
Potassium	106000	1040B	2050B	1230B	7180	7230
Selenium	3.4U	1.6U	1.8U	1.6U	3.4U	3.4U
Silver	1.8B	6.2U	6.2U	6.2U	1.6U	1.6U
Sodium	32900	7810	9930	7710	18600	215000
Thallium	4.4U	1.1U	1.1U	1.1U	4.4U	4.4U
Vanadium	2.4U	4.3U	11.2B	10.4B	5.7B	6.1B
Zinc	104	79.9	85.7	106	44.5	61.3
Cyanide	10.0U	10.0U	10.0U	10.0U	10.0U	10.0U

PROJECT Camp Lejeune
 PREPARED BY Eel Pineda
 DATE April 1997
 CHECKED BY Judy Duma
 DATE 5-8-97
 COMMENTS _____

CAMP LEJEUNE - HPIA
 INORGANICS IN GROUNDWATER (INTERMEDIATE WELLS)
 Concentration in ug/l

CHART = HPI66

wp8e\hp-1nor.wr1 (6)

METAL/COMPOUND	HPGW31-2	HPGW32-2
Aluminum	1100	322
Antimony	13.3U	13.3U
Arsenic	1.5U	1.5U
Barium	17.8B	67.3B
Beryllium	0.50U	0.50U
Cadmium	4.3U	4.3U
Calcium	68200	21500
Chromium	2.4B	11.0
Cobalt	6.0U	6.0U
Copper	12.7B	10.6B
Iron	1320	432
Lead	5.6	6.5
Magnesium	1770B	727B
Manganese	30.0	6.6B
Mercury	0.10U	0.10U
Nickel	6.9B	5.2U
Potassium	1680B	73500
Selenium	3.4U	3.4U
Silver	1.6U	2.2B
Sodium	7720	31800
Thallium	4.4U	4.4U
Vanadium	4.0B	2.4U
Zinc	46.1	62.1
Cyanide	10.0U	10.0U

PROJECT Camp Lejeune
PREPARED BY Judy Yurka
DATE April 1991
CHECKED BY E.O. Kuyf
DATE 5/13/91
REMARKS _____

CAMP LEJEUNE - HPIA
 PESTICIDES IN GROUNDWATER (INTERMEDIATE WELLS)
 Concentration in ug/l

CHART = HPPEST5

sy\wp8b\hp-pest.wr1 (5)

PESTICIDE/PCB	HPGW4-2	HPGW9-2	HPGW17-2	HPGW24-2	HPGW30-2	HPGW30-2D (GWDUP-4)
alpha-BHC	.05U	.05U	.05U	.05U	.05U	.05U
beta-BHC	.05U	.05U	.05U	.05U	.05U	.05U
delta-BHC	.05U	.05U	.05U	.05U	.05U	.05U
gamma-BHC (Lindane)	.05U	.05U	.05U	.05U	.05U	.05U
Heptachlor	.05U	.05U	.05U	.05U	.05U	.05U
Aldrin	.05U	.05U	.05U	.05U	.05U	.05U
Heptachlor epoxide	.05U	.05U	.05U	.05U	.05U	.05U
Endosulfan I	.05U	.05U	.05U	.05U	.05U	.05U
Dieldrin	.10U	.10U	.10U	.10U	.10U	.10U
4,4'-DDE	.10U	.10U	.10U	.10U	.10U	.10U
Endrin	.10U	.10U	.10U	.10U	.10U	.10U
Endosulfan II	.10U	.10U	.10U	.10U	.10U	.10U
4,4'-DDD	.10U	.10U	.10U	.10U	.10U	.10U
Endosulfan sulfate	.10U	.10U	.10U	.10U	.10U	.10U
4,4'-DDT	.10U	.10U	.10U	.10U	.10U	.10U
Methoxychlor	.50U	.50U	.50U	.50U	.50U	.50U
Endrin ketone	.10U	.10U	.10U	.10U	.10U	.10U
alpha-Chlordane	.50U	.50U	.50U	.50U	.50U	.50U
gamma-Chlordane	.50U	.50U	.50U	.50U	.50U	.50U
Toxaphene	1.0U	1.0U	1.0U	1.0U	1.0U	1.0U
Aroclor-1016	.50U	.50U	.50U	.50U	.50U	.50U
Aroclor-1221	.50U	.50U	.50U	.50U	.50U	.50U
Aroclor-1232	.50U	.50U	.50U	.50U	.50U	.50U
Aroclor-1242	.50U	.50U	.50U	.50U	.50U	.50U
Aroclor-1248	.50U	.50U	.50U	.50U	.50U	.50U
Aroclor-1254	1.0U	1.0U	1.0U	1.0U	1.0U	1.0U
Aroclor-1260	1.0U	1.0U	1.0U	1.0U	1.0U	1.0U

PROJECT Camp Lejeune
 PREPARED BY Judy Suma
 DATE April 1991
 CHECKED BY Mundy Seysa
 DATE 5/10/91

CAMP LEJEUNE - HPIA
 PESTICIDES IN GROUNDWATER (INTERMEDIATE WELLS)
 Concentration in ug/l

CHART = HPPEST6

sy\wp8b\hp-pest.wr1 (6)

PESTICIDE/PCB	HPGW31-2	HPGW32-2
alpha-BHC	.05U	.05U
beta-BHC	.05U	.05U
delta-BHC	.05U	.05U
gamma-BHC (Lindane)	.05U	.05U
Heptachlor	.05U	.05U
Aldrin	.05U	.05U
Heptachlor epoxide	.05U	.05U
Endosulfan I	.05U	.05U
Dieldrin	.10U	.10U
4,4'-DDE	.10U	.10U
Endrin	.10U	.10U
Endosulfan II	.10U	.10U
4,4'-DDD	.10U	.10U
Endosulfan sulfate	.10U	.10U
4,4'-DDT	.10U	.10U
Methoxychlor	.50U	.50U
Endrin ketone	.10U	.10U
alpha-Chlordane	.50U	.50U
gamma-Chlordane	.50U	.50U
Toxaphene	1.0U	1.0U
Aroclor-1016	.50U	.50U
Aroclor-1221	.50U	.50U
Aroclor-1232	.50U	.50U
Aroclor-1242	.50U	.50U
Aroclor-1248	.50U	.50U
Aroclor-1254	1.0U	1.0U
Aroclor-1260	1.0U	1.0U

PROJECT	<u>Camp Lejeune</u>
PREPARED BY	<u>Jerry Hund</u>
DATE	<u>April 1991</u>
CHECKED BY	<u>Ed Krugel</u>
DATE	<u>5/6/91</u>
COMMENTS	<u></u>

APPENDIX M

**CHARACTERIZATION INVESTIGATION
DEEP MONITOR WELLS
ANALYTICAL RESULTS**

PROJECT NUMBER 86447 0406
FIELD GROUP LJHP-4PROJECT NAME NAVY - LEJEUNE HP4
LAB COORDINATOR JEFF SHAMIS

SAMPLE ID/#

PARAMETERS	STORET #	SAMPLE ID/#		
		HPGW9-3 LJHP-4	HPGW17-3 LJHP-4	HPGW24-2 LJHP-4
UNITS	METHOD	2	4	5
DATE		08/06/87	08/05/87	08/06/87
TIME		12:14	16:04	13:15
BENZENE	34030	<1.0	<1.0	<1.0
UG/L	GMS			
BROMODICHLOROMETHANE	32101	<2.2	<2.2	<2.2
UG/L	GMS			
BROMOFORM	32104	<4.7	<4.7	<4.7
UG/L	GMS			
BROMOMETHANE	34413	<5.8	<5.8	<5.8
UG/L	GMS			
CARBON TETRACHLORIDE	32102	<2.8	<2.8	<2.8
UG/L	GMS			
CHLOROBENZENE	34301	<6.0	<6.0	<6.0
UG/L	GMS			
CHLOROETHANE	34311	<8.2	<8.2	<8.2
UG/L	GMS			
2-CHLOROETHYL VINYL	34576	<15	<15	<15
ETHER	UG/L	GMS		
CHLOROFORM	32106	<1.6	<1.6	<1.6
UG/L	GMS			
CHLOROMETHANE	34418	<4.3	<4.3	<4.3
UG/L	GMS			
DIBROMOCHLOROMETHANE	32105	<3.1	<3.1	<3.1
UG/L	GMS			
1,1-DICHLOROETHANE	34496	<4.7	<4.7	<4.7
UG/L	GMS			
1,2-DICHLOROETHANE	34531	<2.8	<2.8	<2.8
UG/L	GMS			
1,1-DICHLOROETHYLENE	34501	<2.8	<2.8	<2.8
UG/L	GMS			
TRANS-1,2-DICHLORO	34546	<1.6	<1.6	<1.6
ETHENE	UG/L	GMS		
1,2-DICHLOROPROPANE	34541	<6.0	<6.0	<6.0
UG/L	GMS			
CIS-1,3-DICHLORO	34704	<5.0	<5.0	<5.0
PROPENE	UG/L	GMS		
TRANS-1,3-DICHLORO	34699	<6.4	<6.4	<6.4
PROPENE	UG/L	GMS		
ETHYLBENZENE	34371	<7.2	<7.2	<7.2
UG/L	GMS			
METHYLENE CHLORIDE	34423	<50	<50	<50
UG/L	GMS			

PROJECT NUMBER 86447 0406
 FIELD GROUP LJHP-4

PROJECT NAME NAVY - LEJEUNE HP4
 LAB COORDINATOR JEFF SHAMIS

SAMPLE ID/#

PARAMETERS	STORET #	HPGW9-3	HPGW17-3	HPGW24-3
		LJHP-4	LJHP-4	LJHP-4
UNITS	METHOD	2	4	6
DATE		08/06/87	08/05/87	08/06/87
TIME		12:14	16:04	13:28
1,1,2,2-TETRACHLOROETHANE	34516	<4.1	<4.1	<4.1
UG/L	GMS			
TETRACHLOROETHENE	34475	<3.0	<3.0	<3.0
UG/L	GMS			
TOLUENE	34010	<6.0	<6.0	<6.0
UG/L	GMS			
1,1,1-TRICHL'ETHANE	34506	<3.8	<3.8	<3.8
UG/L	GMS			
1,1,2-TRICHL'ETHANE	34511	<5.0	<5.0	<5.0
UG/L	GMS			
TRICHLOROETHENE	39180	<1.0	<1.0	<1.0
UG/L	GMS			
TRICHLOROFUORO-METHANE	34488	<3.2	<3.2	<3.2
UG/L	GMS			
VINYL CHLORIDE	39175	<1.0	<1.0	<1.0
UG/L	GMS			
ACROLEIN	34210	<100	<100	<100
UG/L	GMS			
ACRYLONITRILE	34215	<100	<100	<100
UG/L	GMS			
DICHLORODIFLUORO-METHANE	34668	<10	<10	<10
UG/L	GMS			
M-XYLENE	98553	<12	<12	<12
UG/L	GMS			
O-AND/OR-P XYLENE	98554	<12	<12	<12
UG/L	GMS			
METHYL ETHYL KETONE	81595	140	290	<48
UG/L	GMS			
METHYL ISOBUT'KETONE	81596	<12	<12	<12
UG/L	GMS			

APPENDIX N

**SUPPLEMENTAL CHARACTERIZATION INVESTIGATION
DEEP MONITOR WELLS
ANALYTICAL RESULTS**

CAMP LEJEUNE - HPIA
SEMI-VOLATILE ORGANIC COMPOUNDS IN GROUNDWATER (DEEP WELLS)
Concentration in ug/l

CHART = HPSV7A

wp8c\hp-sv.wr1 (7-A)

COMPOUND	HPGW4-3	HPGW9-3	HPGW9-3D (GWDUP3)	HPGW24-3	HPGW30-3	HPGW31-3	HPGW32-3
Phenol	10.U	10.U	10.U	10.U	10.U	10.U	10.U
bis(2-Chloroethyl)ether	10.U	10.U	10.U	10.U	10.U	10.U	10.U
2-Chlorophenol	10.U	10.U	10.U	10.U	10.U	10.U	10.U
1,3-Dichlorobenzene	10.U	10.U	10.U	10.U	10.U	10.U	10.U
1,4-Dichlorobenzene	10.U	10.U	10.U	10.U	10.U	10.U	10.U
Benzyl Alcohol	10.U	10.U	10.U	10.U	10.U	10.U	10.U
1,2-Dichlorobenzene	10.U	10.U	10.U	10.U	10.U	10.U	10.U
2-Methylphenol	10.U	10.U	10.U	10.U	10.U	10.U	10.U
bis(2-Chloroisopropyl)ether	10.U	10.U	10.U	10.U	10.U	10.U	10.U
4-Methylphenol	10.U	10.U	10.U	10.U	10.U	10.U	10.U
N-Nitroso-di-n-propylamine	10.U	10.U	10.U	10.U	10.U	10.U	10.U
Hexachloroethane	10.U	10.U	10.U	10.U	10.U	10.U	10.U
Nitrobenzene	10.U	10.U	10.U	10.U	10.U	10.U	10.U
Isophorone	10.U	10.U	10.U	10.U	10.U	10.U	10.U
2-Nitrophenol	10.U	10.U	10.U	10.U	10.U	10.U	10.U
2,4-Dimethylphenol	10.U	10.U	10.U	10.U	10.U	10.U	10.U
Benzoic acid	50.U	50.U	50.U	50.U	50.U	50.U	50.U
bis(2-Chloroethoxy)methane	10.U	10.U	10.U	10.U	10.U	10.U	10.U
2,4-Dichlorophenol	10.U	10.U	10.U	10.U	10.U	10.U	10.U
1,2,4-Trichlorobenzene	10.U	10.U	10.U	10.U	10.U	10.U	10.U
Naphthalene	10.U	10.U	10.U	10.U	10.U	10.U	10.U
4-Chloroaniline	10.U	10.U	10.U	10.U	10.U	10.U	10.U
Hexachlorobutadiene	10.U	10.U	10.U	10.U	10.U	10.U	10.U
4-Chloro-3-methylphenol	10.U	10.U	10.U	10.U	10.U	10.U	10.U
2-Methylnaphthalene	10.U	10.U	10.U	10.U	10.U	10.U	10.U
Hexachlorocyclopentadiene	10.U	10.U	10.U	10.U	10.U	10.U	10.U
2,4,6-Trichlorophenol	10.U	10.U	10.U	10.U	10.U	10.U	10.U
2,4,5-Trichlorophenol	50.U	50.U	50.U	50.U	50.U	50.U	50.U
2-Chloronaphthalene	10.U	10.U	10.U	10.U	10.U	10.U	10.U
2-Nitroaniline	50.U	50.U	50.U	50.U	50.U	50.U	50.U
Dimethylphthalate	10.U	10.U	10.U	10.U	10.U	10.U	10.U
Acenaphthylene	10.U	10.U	10.U	10.U	10.U	10.U	10.U
2,6-Dinitrotoluene	10.U	10.U	10.U	10.U	10.U	10.U	10.U

PROJECT	<u>Camp Lejeune</u>
PREPARED BY	<u>Judy Bunn</u>
DATE	<u>April 1991</u>
CHECKED BY	<u>E.L. Campbell</u>
DATE	<u>5/10/91</u>
COMMENTS	

CAMP LEJEUNE - HPIA
 PESTICIDES IN GROUNDWATER (DEEP WELLS)
 Concentration in ug/l

CHART = HPPEST7

sy\wp8b\hp-pest.wr1 (7)

PESTICIDE/PCB	HPGW9-3D						
	HPGW4-3	HPGW9-3	(GWDUP3)	HPGW24-3	HPGW30-3	HPGW31-3	HPGW32-3
alpha-BHC	.05U	.05U	.05U	.05U	.05U	.05U	.05U
beta-BHC	.05U	.05U	.05U	.05U	.05U	.05U	.05U
delta-BHC	.05U	.05U	.05U	.05U	.05U	.05U	.05U
gamma-BHC (Lindane)	.05U	.05U	.05U	.05U	.05U	.05U	.05U
Heptachlor	.05U	.05U	.05U	.05U	.05U	.05U	.05U
Aldrin	.05U	.05U	.05U	.05U	.05U	.05U	.05U
Heptachlor epoxide	.05U	.05U	.05U	.05U	.05U	.05U	.05U
Endosulfan I	.05U	.05U	.05U	.05U	.05U	.05U	.05U
Dieldrin	.10U	.10U	.10U	.10U	.10U	.10U	.10U
4,4'-DDE	.10U	.10U	.10U	.10U	.10U	.10U	.10U
Endrin	.10U	.10U	.10U	.10U	.10U	.10U	.10U
Endosulfan II	.10U	.10U	.10U	.10U	.10U	.10U	.10U
4,4'-DDD	.10U	.10U	.10U	.10U	.10U	.10U	.10U
Endosulfan sulfate	.10U	.10U	.10U	.10U	.10U	.10U	.10U
4,4'-DDT	.10U	.10U	.10U	.10U	.10U	.10U	.10U
Methoxychlor	.50U	.50U	.50U	.50U	.50U	.50U	.50U
Endrin ketone	.10U	.10U	.10U	.10U	.10U	.10U	.10U
alpha-Chlordane	.50U	.50U	.50U	.50U	.50U	.50U	.50U
gamma-Chlordane	.50U	.50U	.50U	.50U	.50U	.50U	.50U
Toxaphene	1.0U	1.0U	1.0U	1.0U	1.0U	1.0U	1.0U
Aroclor-1016	.50U	.50U	.50U	.50U	.50U	.50U	.50U
Aroclor-1221	.50U	.50U	.50U	.50U	.50U	.50U	.50U
Aroclor-1232	.50U	.50U	.50U	.50U	.50U	.50U	.50U
Aroclor-1242	.50U	.50U	.50U	.50U	.50U	.50U	.50U
Aroclor-1248	.50U	.50U	.50U	.50U	.50U	.50U	.50U
Aroclor-1254	1.0U	1.0U	1.0U	1.0U	1.0U	1.0U	1.0U
Aroclor-1260	1.0U	1.0U	1.0U	1.0U	1.0U	1.0U	1.0U

PROJECT Camp Lejeune
 PREPARED BY Judy Hummer
 DATE April 1991
 CHECKED BY EL Kuyper
 DATE 5/6/91
 COMMENTS _____

APPENDIX O

**SUPPLEMENTAL CHARACTERIZATION INVESTIGATION
WATER SUPPLY WELLS
ANALYTICAL RESULTS**

CAMP LEJEUNE - HPIA
 INORGANICS IN GROUNDWATER (WATER SUPPLY WELLS)
 Concentration in ug/l

CHART = HPWSING

wp8e\hp-inor.wr1 (8)

METAL/COMPOUND	WS-602	WS-603	WS-634	WS-634D (GWDUP9)	WS-637	WS-642	WS-652	WS-660
Aluminum	95.2B	20.7U	20.7U	20.7U	20.7U	20.7U	20.7U	20.7U
Antimony	13.3U	13.3U	13.3U	13.3U	13.3U	13.3U	13.3U	13.3U
Arsenic	1.5U	1.5U	1.5U	1.5U	1.5U	1.5U	1.5U	1.5U
Barium	4.8B	8.7B	10.2B	10.4B	9.5B	7.6B	376	10.3B
Beryllium	0.50U	0.50U	0.50U	0.86B	0.50U	0.50U	0.50U	0.50U
Cadmium	4.3U	4.3U	4.3U	4.3U	4.3U	4.3U	4.3U	4.3U
Calcium	128000	91400	58900	61200	62700	74100	69000	91900
Chromium	1.5U	1.5U	1.5U	1.5U	1.5U	1.5U	1.7B	1.5U
Cobalt	6.0U	6.0U	6.0U	6.0U	6.0U	6.0U	6.0U	6.0U
Copper	97.1	3.2U	4.9B	4.0B	17.9B	8.5B	22.5B	5.0B
Iron	12800	1030	1420	1550	4620	1150	65000	11500
Lead	8.8	1.7U	1.7U	1.7U	3.3	1.7U	32.8	21.8
Magnesium	5440	3240B	1190B	1240B	1650B	1690B	1910B	2800B
Manganese	120	22.2	12.5B	12.5B	28.3	24.6	151	75.6
Mercury	0.10U	0.10U	0.10U	0.10U	0.10U	0.10U	0.10U	0.10U
Nickel	5.2U	5.2U	5.2U	5.2U	5.2U	5.2U	5.2U	5.2U
Potassium	2100B	2620B	890B	1090B	1370B	1390B	1200B	2040B
Selenium	3.4U	3.4U	3.4U	3.4U	3.4U	3.4U	3.4U	3.4U
Silver	1.6U	1.6U	1.6U	1.6U	1.6U	1.6U	2.2B	1.6U
Sodium	12500	11000	5410	5900	7900	7730	8680	8730
Thallium	4.4U	4.4U	4.4U	4.4U	4.4U	4.4U	4.4U	4.4U
Vanadium	2.4B	2.4U	2.4U	2.5B	2.4U	2.4U	2.4U	2.7B
Zinc	112	39.9	23.4	14.3B	86.7	38.6	18100	4590
Cyanide	10.0U	10.0U	10.0U	10.0U	10.0U	10.0U	10.0U	10.0U

PROJECT Camp Lejeune
 PREPARED BY [Signature]
 DATE 5/11/91
 CHECKED BY [Signature]
 DATE 5/10/91

REVIEWS _____

APPENDIX P

**CHARACTERIZATION INVESTIGATION
SOIL GAS LOCATIONS AND DATA**

ESE
P. O. Box ESE
GAINESVILLE, FL 32602
(904) 332-3318

NOT TO SCALE (MEASUREMENTS TO NEAREST FOOT)

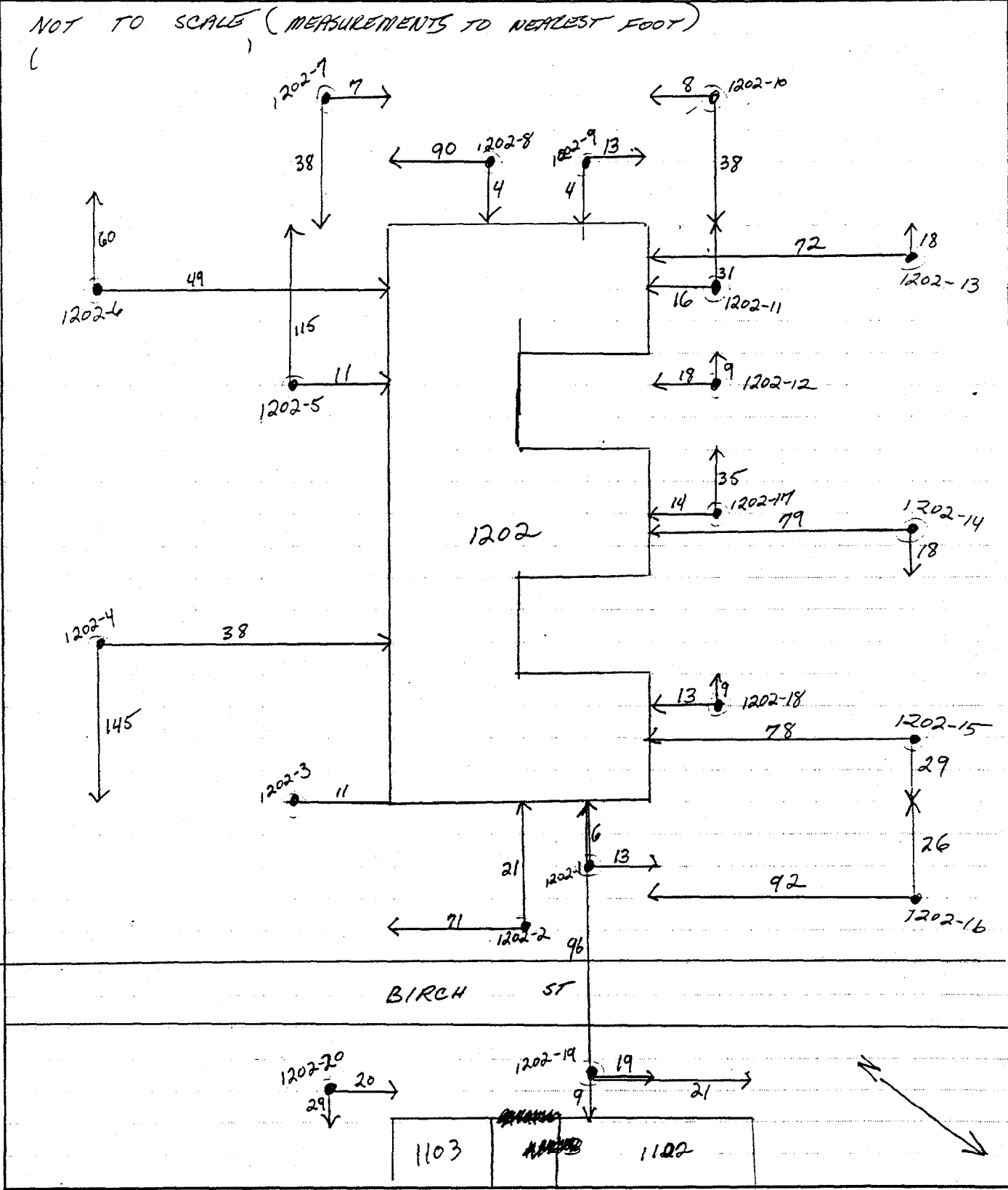

Table B-1. Soil Gas Data For Building 1202.

Sample ID	TCE* (nl/l)+
1202-1	<10
1202-2	53
1202-3	<10
1202-4	<10
1202-5	<10
1202-6	<10
1202-7	<10
1202-8	<10
1202-9	<10
1202-10	1760
1202-11	8200
1202-12	37
1202-13	24000
1202-14	64
1202-15	36
1202-16	15
1202-17	14700
1202-18	13200
1202-19	36770
1202-20	116

Note: * TCE = Trichloroethene
+ nl/l = nanoliter per liter (parts per billion)

Source: ESE, 1987.

Not To Scale 10.21.86
 All measurements in feet to nearest foot

JOB _____ OF _____
 SHEET NO. _____ DATE 10/21/86
 CALCULATED BY _____ DATE _____
 CHECKED BY _____ DATE _____

ESE
 P. O. Box ESE
 GAINESVILLE, FL 32602
 (904) 332-3318

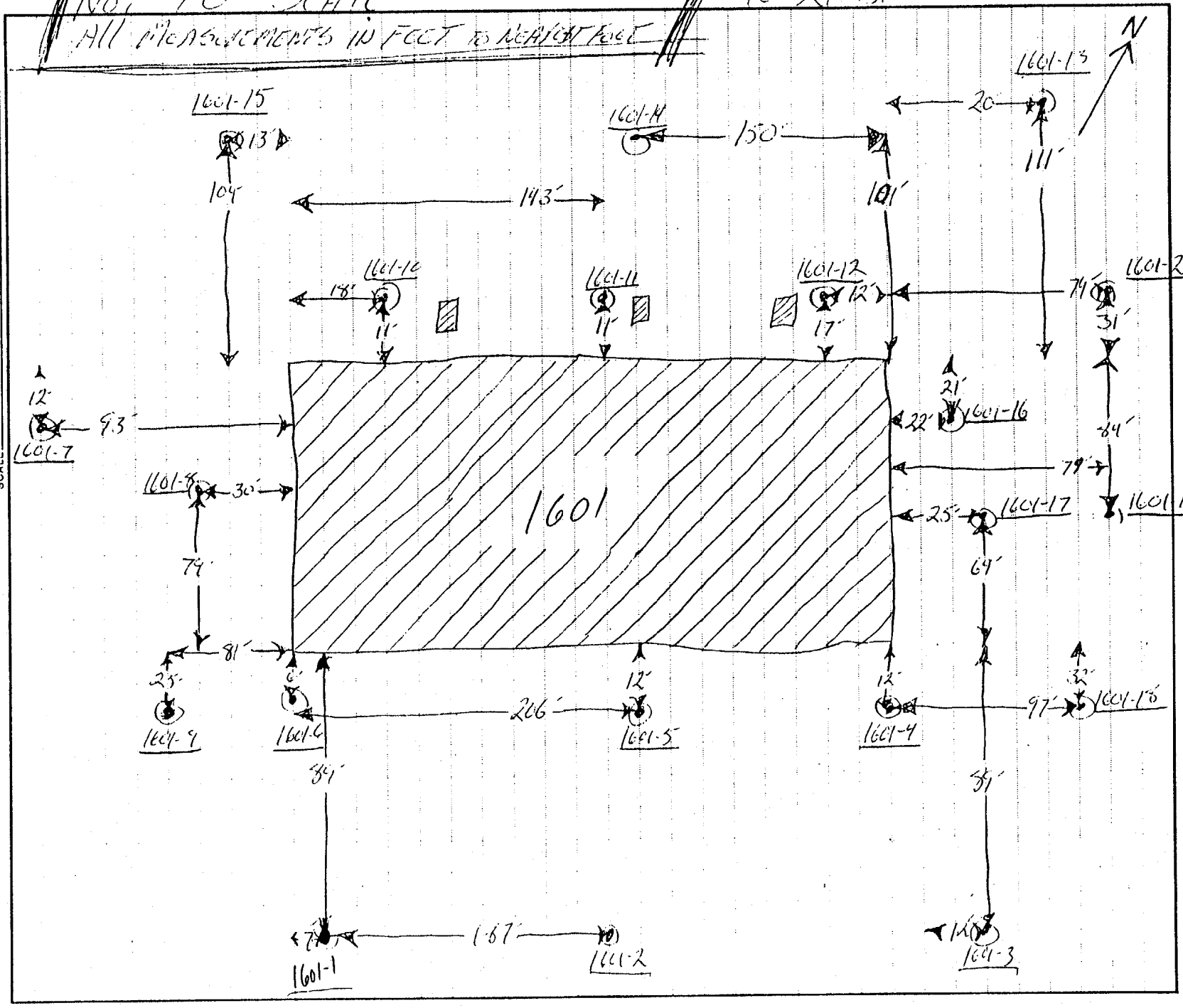

Table B-2. Soil Gas Data For Building 1601.

Sample ID	TCE* (ng/l)+
1601-1	<10
1601-2	10
1601-3	41400
1601-4	18130
1601-5	79
1601-6	33
1601-7	43
1601-8	43
1601-9	10
1601-10	<10
1601-11	<10
1601-12	2630
1601-13	10
1601-14	<10
1601-15	<10
1601-16	7440
1601-17	703000
1601-18	68000
1601-19	22450
1601-20	20

Note: * TCE = Trichloroethene
+ nl/l = nanoliter per liter (parts per billion)

Source: ESE, 1987.

ESE
P. O. Box ESE
GAINESVILLE, FL 32602
(904) 332-3318

JOB _____
SHEET NO. _____ OF _____
CALCULATED BY M. SMAR DATE 10/22/66
CHECKED BY _____ DATE _____
SCALE _____

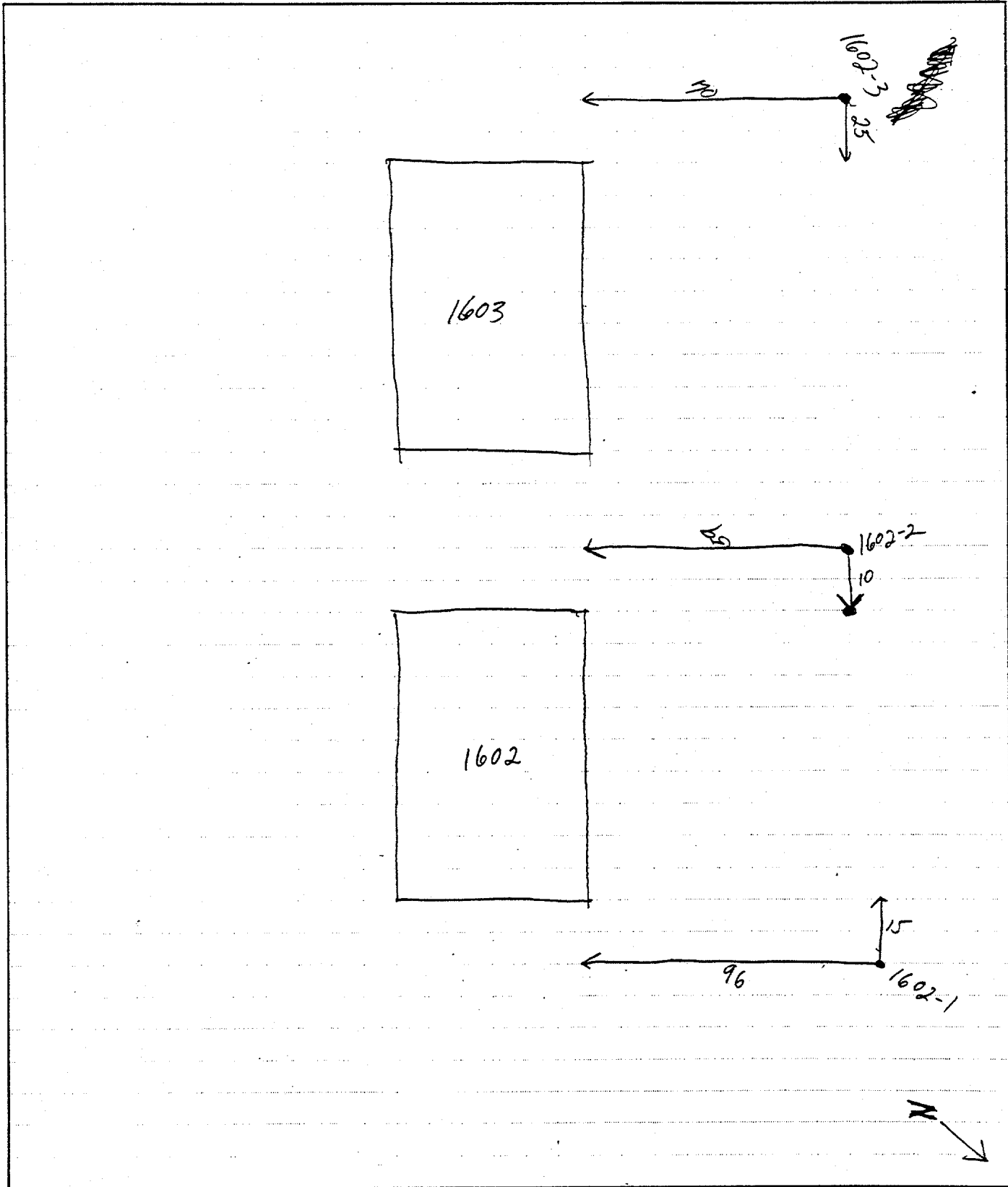

ESE
 P. O. Box ESE
 GAINESVILLE, FL 32602
 (904) 332-3318

JOB _____
 SHEET NO. _____ OF _____
 CALCULATED BY W. SMITH DATE 10/23/86
 CHECKED BY _____ DATE _____
 SCALE _____

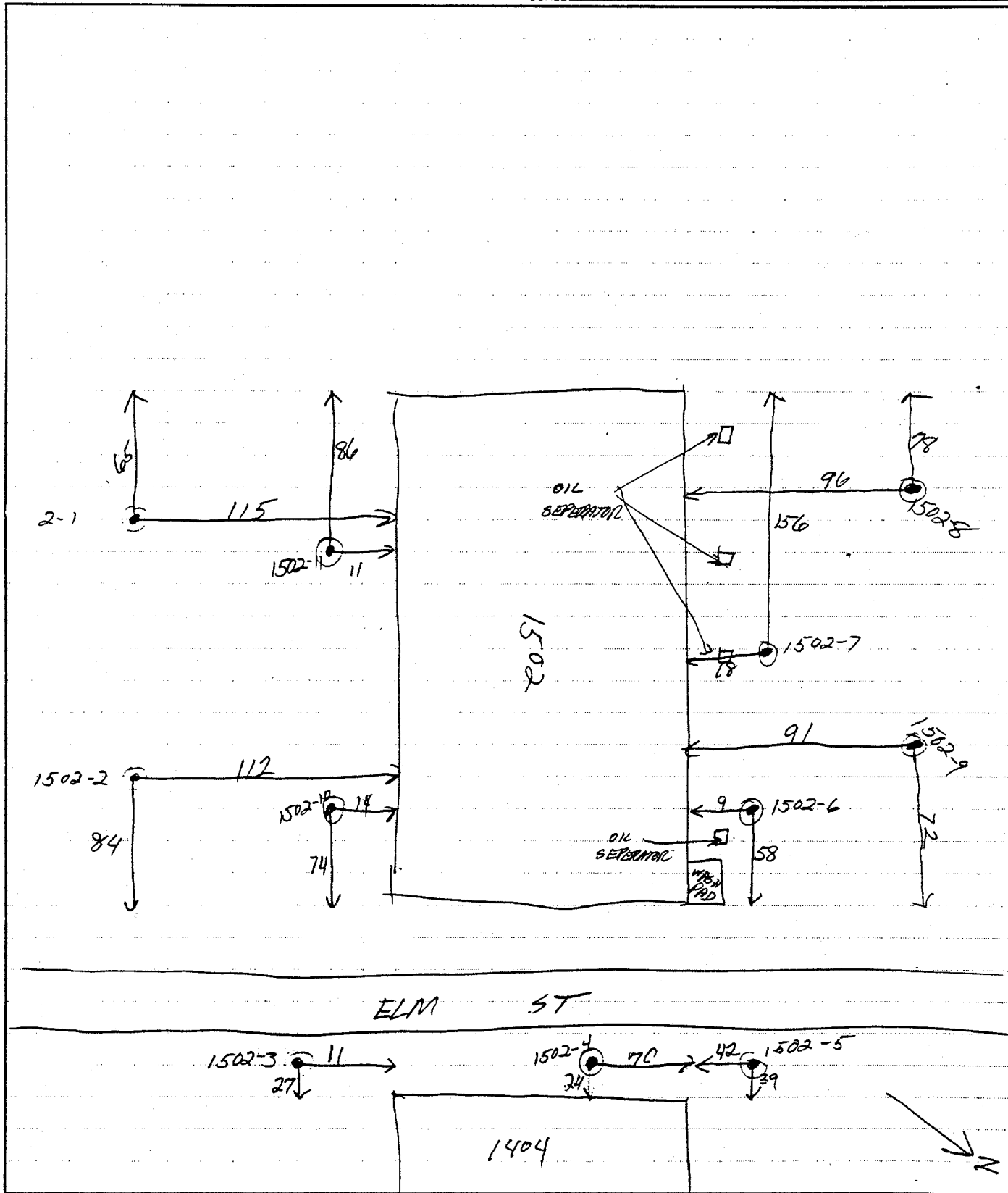

Table B-3. Soil Gas Data For Buildings 1502 and 1602.

Sample ID	TCE* (nl/l)+
1502-1	16
1502-2	33
1502-3	13
1502-4	16
1502-5	30
1502-6	<10
1502-7	10
1502-8	13
1502-9	14
1502-10	15
1502-11	<10
1602-1	29
1602-2	10
1602-3	53

Note: * TCE = Trichloroethene
+ nl/l = nanoliter per liter (parts per billion)

Source: ESE, 1987.

ESE
P. O. Box ESE
GAINESVILLE, FL 32602
(904) 332-3318

JOB _____ 118 34
SHEET NO. _____ OF _____
CALCULATED BY _____ DATE 10/27/86
CHECKED BY _____ DATE _____
SCALE _____

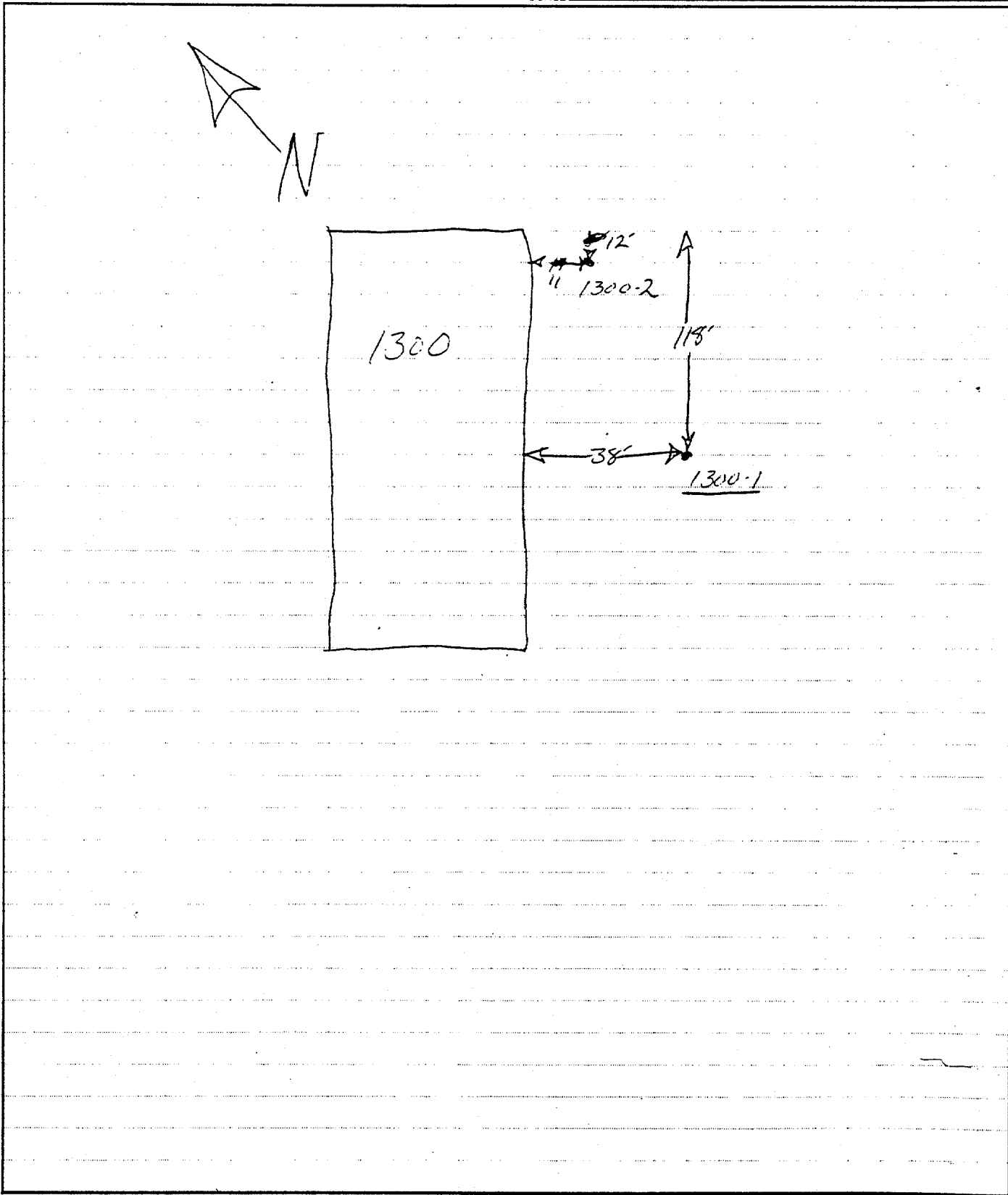

ESE
 P. O. Box ESE
 GAINESVILLE, FL 32602
 (904) 332-3318

JOB _____
 SHEET NO. _____ OF _____
 CALCULATED BY M. GONZA DATE 10/23/86
 CHECKED BY _____ DATE _____
 SCALE _____

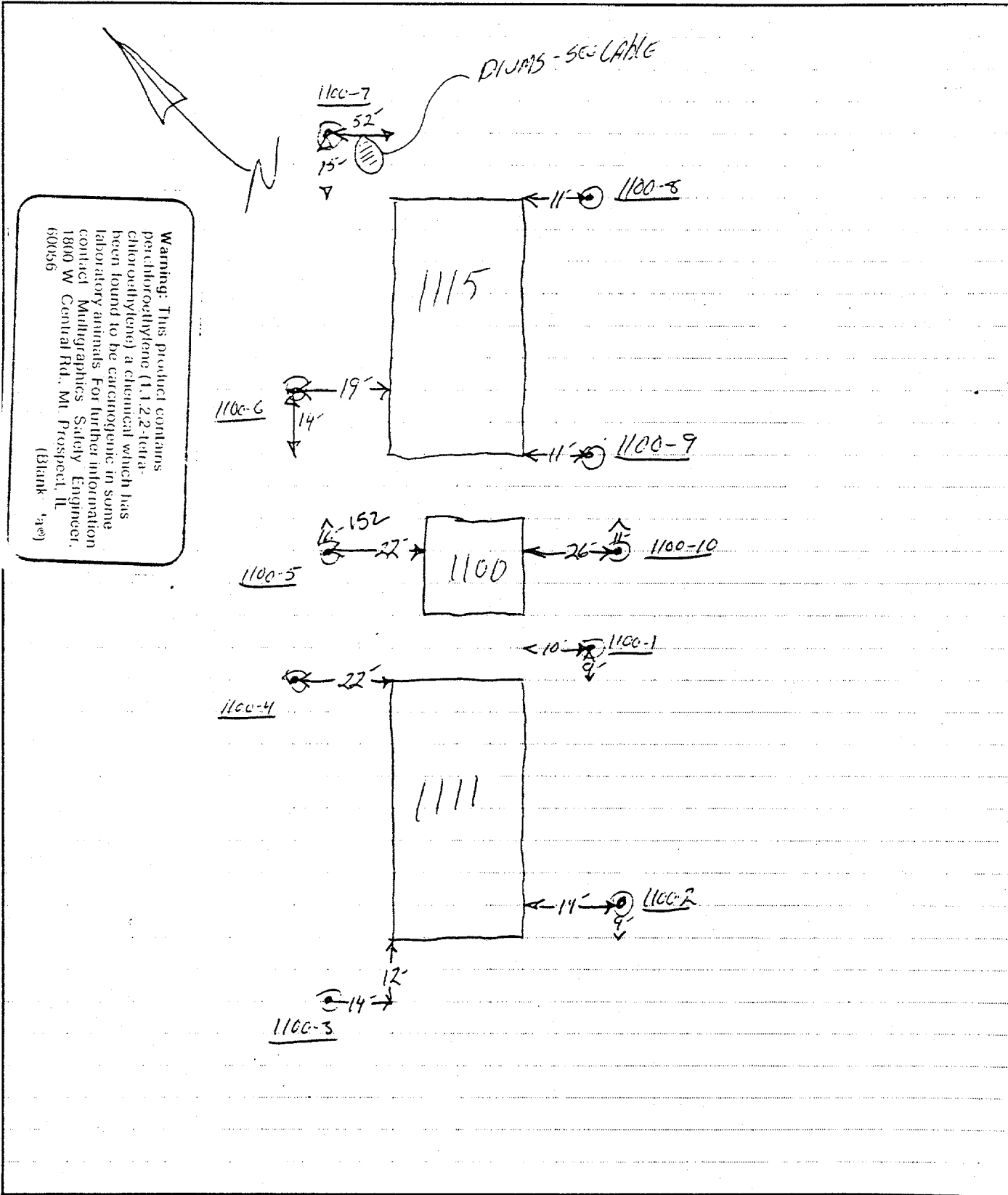

Table B-4. Soil Gas Data For Buildings 1300 and 1100.

Sample ID	TCE* (nl/l)+
1300-1	295
1300-2	<10
1100-1	<10
1100-2	<10
1100-3	10
1100-4	<10
1100-5	152
1100-6	<10
1100-7	<10
1100-8	<10
1100-9	<1000
1100-10	<2000

Note: * TCE = Trichloroethene
+ nl/l = nanoliter per liter (parts per billion)

Source: ESE, 1987.

ESE
P. O. Box ESE
GAINESVILLE, FL 32602
(904) 332-3318

JOB _____
SHEET NO. _____ OF _____
CALCULATED BY M. SMAR DATE 10/23/86
CHECKED BY _____ DATE _____
SCALE _____

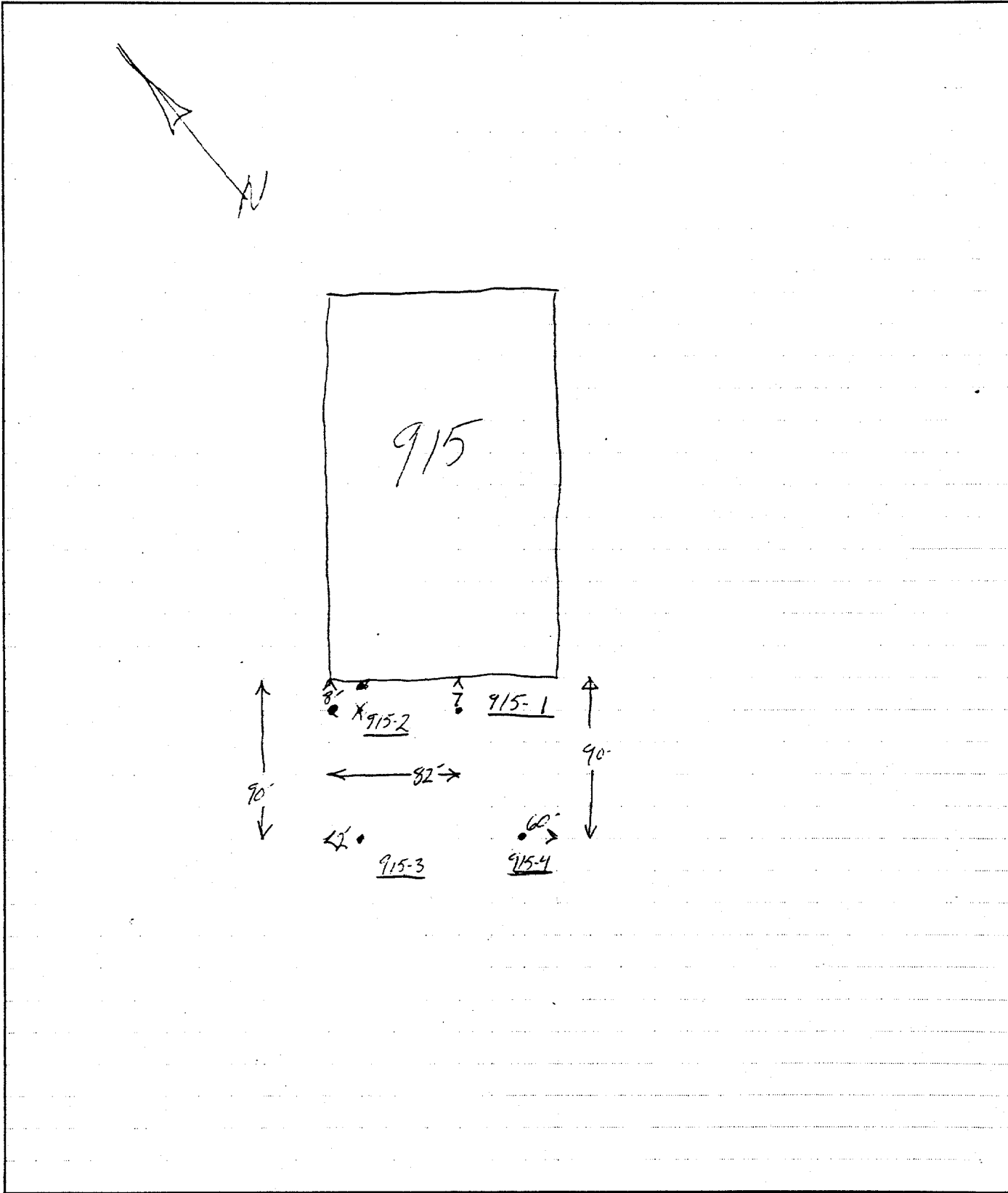

Table B-5. Soil Gas Data For Building 915.

Sample ID	TCE* (nl/l)+
915-1	<10
915-2	<10
915-3	<10
915-4	<10

Note: * TCE = Trichloroethene
+ nl/l = nanoliter per liter (parts per billion)

Source: ESE, 1987.

ESE
 P. O. Box ESE
 GAINESVILLE, FL 32602
 (904) 332-3318

JOB _____
 SHEET NO. _____ OF _____
 CALCULATED BY M. SMAR DATE _____
 CHECKED BY 10/24/86 DATE _____
 SCALE _____

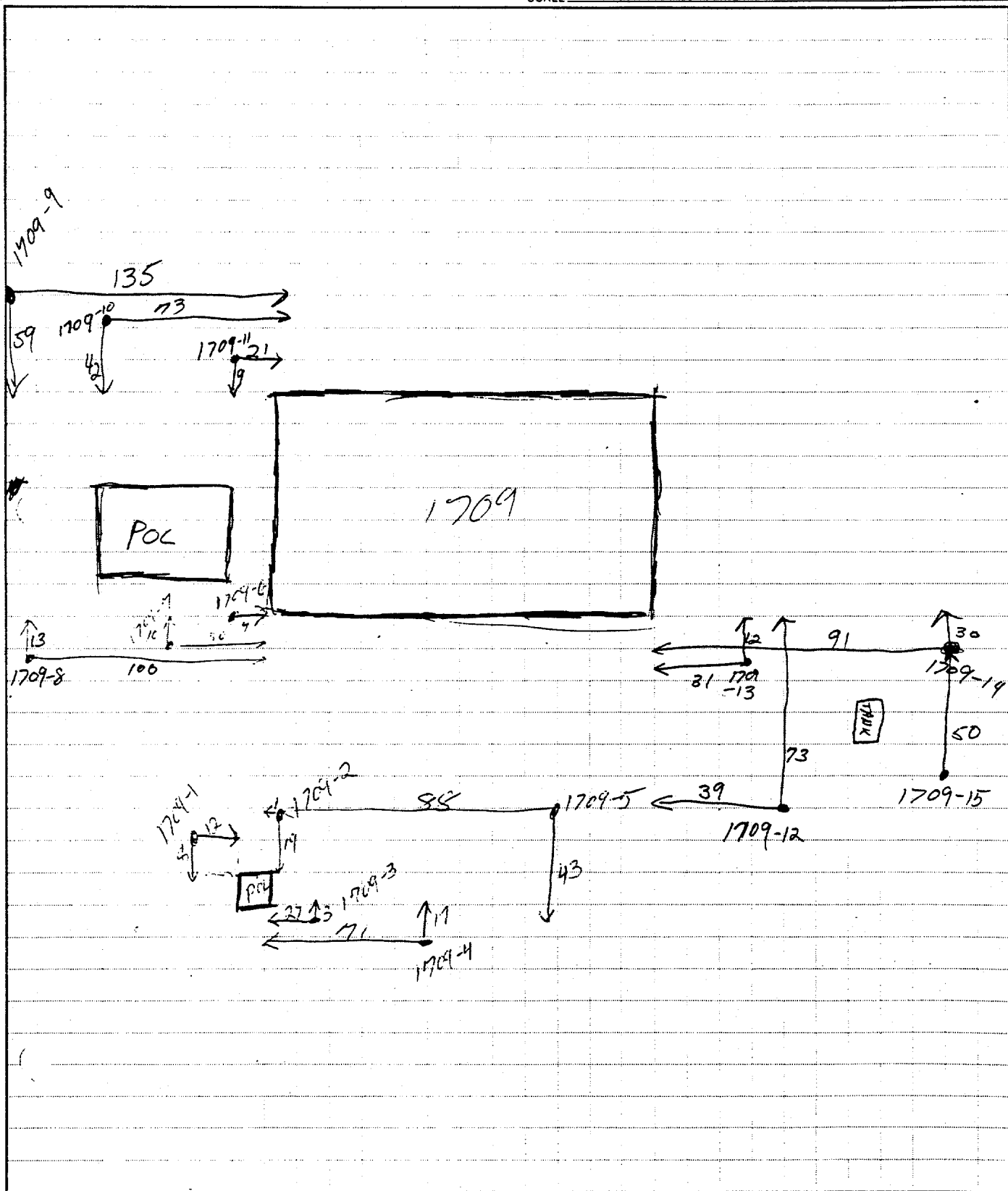

ESE
P. O. Box ESE
GAINESVILLE, FL 32602
(904) 332-3318

JOB _____
SHEET NO. _____ OF _____
CALCULATED BY M. SMITH DATE _____
CHECKED BY 10/24/86 DATE _____
SCALE _____

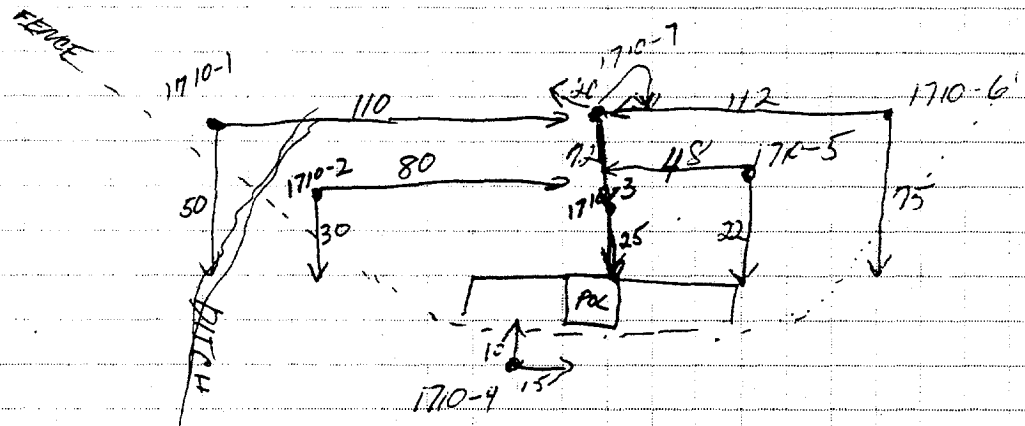
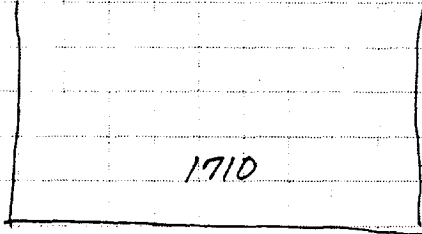

Table B-6. Soil Gas Data For Buildings 1709 and 1710.

Sample ID	TCE* (nl/l)+
1709-1	<10
1709-2	35
1709-3	53000
1709-4	<10
1709-5	<10
1709-6	<10
1709-7	<100
1709-8	<10
1709-9	<1000
1709-10	<10
1709-11	<10
1709-12	<10
1709-13	<10
1709-14	<10
1709-15	<10
1710-1	<10
1710-2	<1000
1710-3	<10
1710-4	<10
1710-5	<1000
1710-6	<1000
1710-7	<100000

Note: * TCE = Trichloroethene

+ nl/l = nanoliter per liter (parts per billion)

Source: ESE, 1987.

ESE
P. O. Box ESE
GAINESVILLE, FL 32602
(904) 332-3318

JOB _____
SHEET NO. _____ OF _____
CALCULATED BY _____ DATE 10/27/86
CHECKED BY _____ DATE _____
SCALE _____

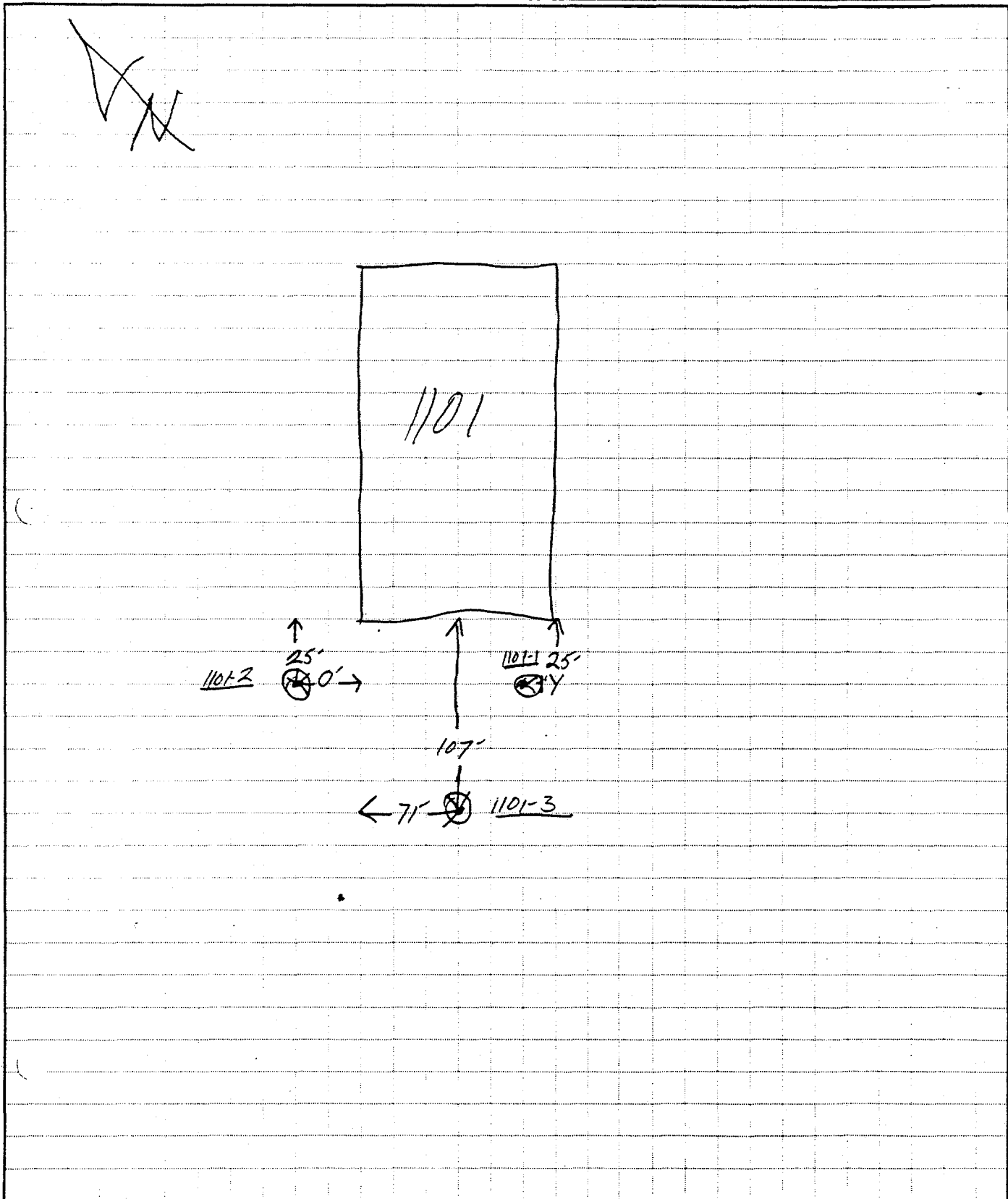

ESE
P. O. Box ESE
GAINESVILLE, FL 32602
(904) 332-3318

JOB _____
SHEET NO. _____ OF _____
CALCULATED BY _____ DATE 10/27/86
CHECKED BY _____ DATE _____
SCALE _____

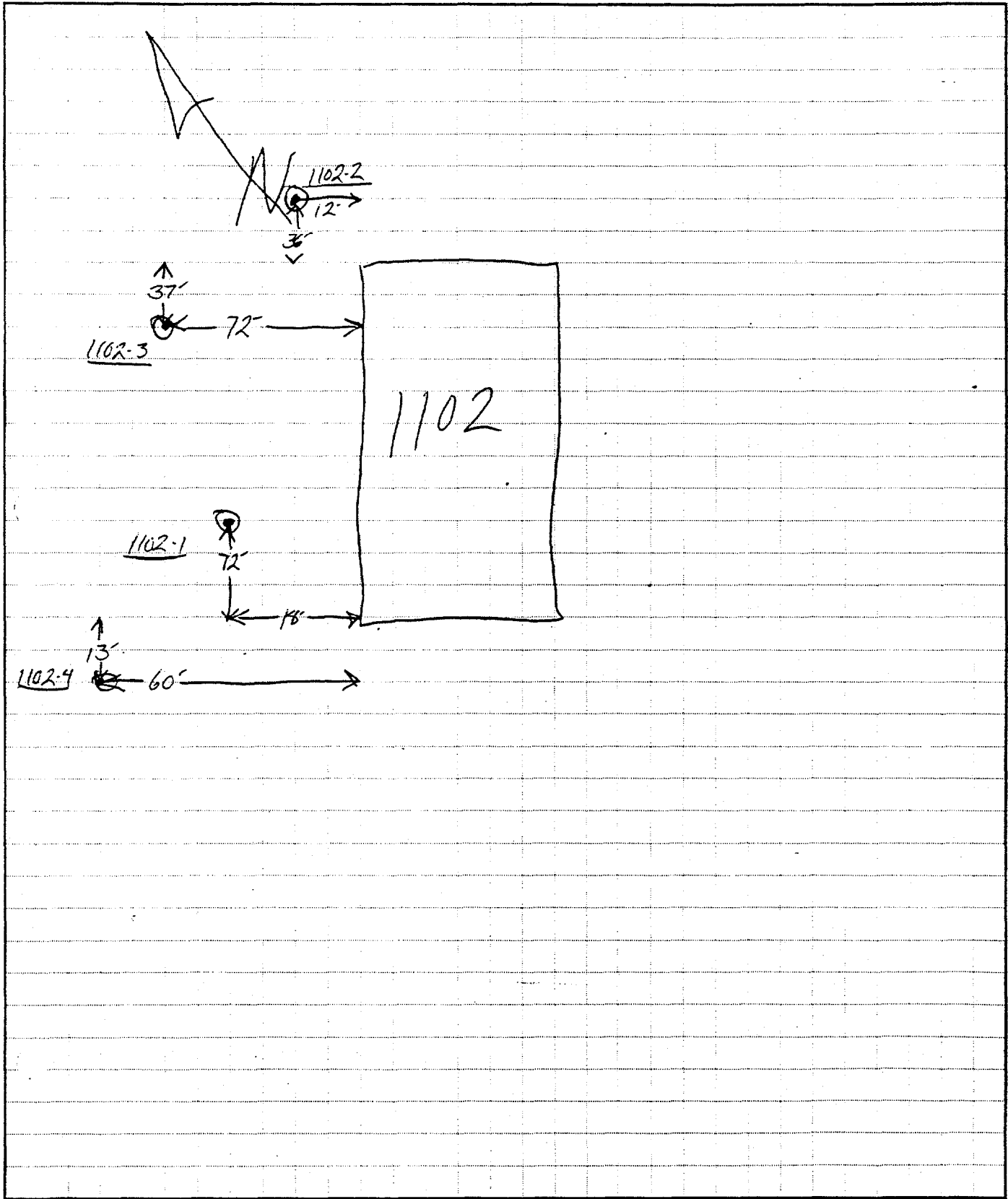

ESE
P. O. Box ESE
GAINESVILLE, FL 32602
(904) 332-3318

JOB _____
SHEET NO. _____ OF _____
CALCULATED BY M. SALAD DATE 10/23/86
CHECKED BY _____ DATE _____
SCALE _____

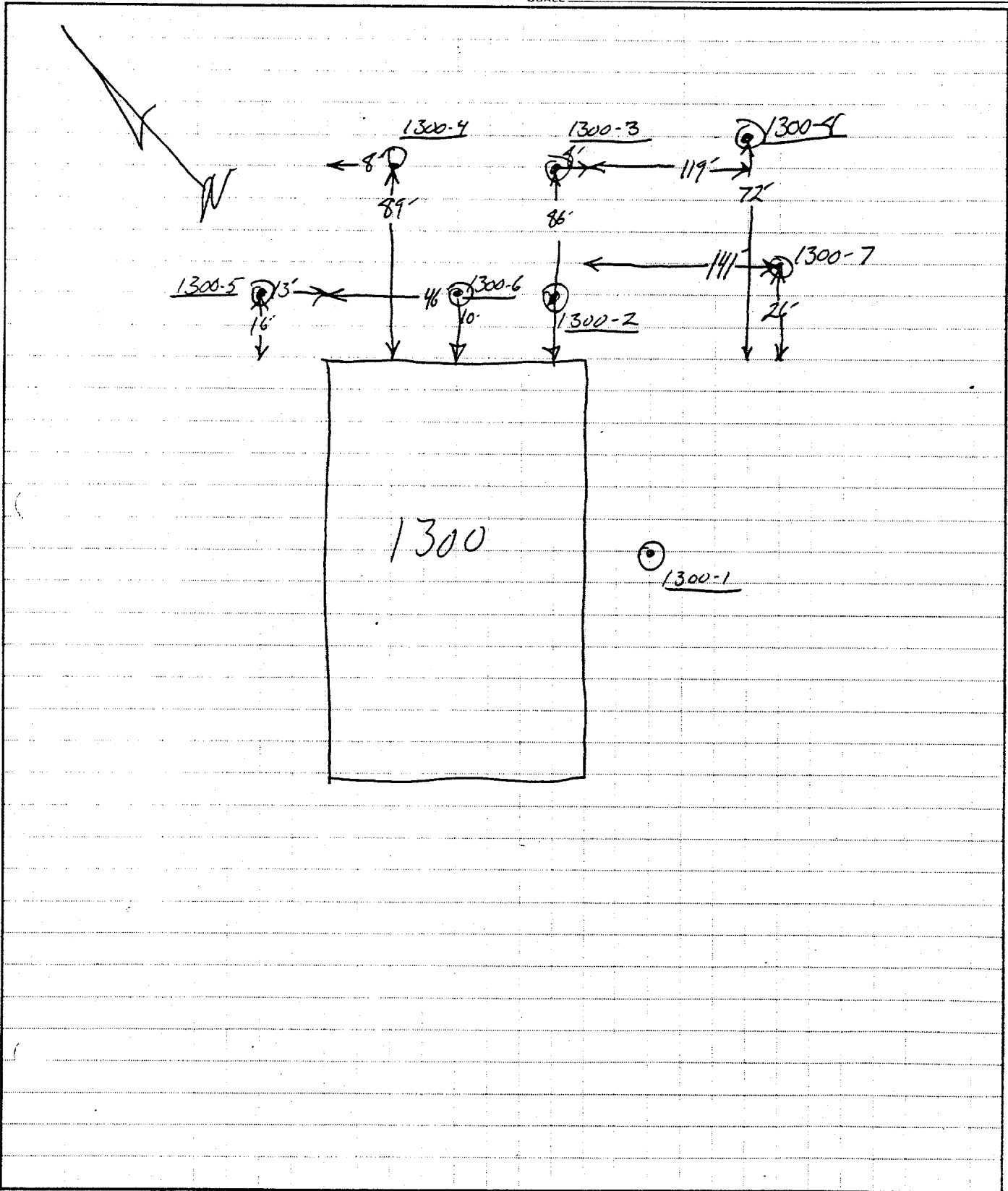

ESE
P. O. Box ESE
GAINESVILLE, FL 32602
(904) 332-3318

JOB _____
SHEET NO. _____ OF _____
CALCULATED BY _____ DATE _____
CHECKED BY _____ DATE _____
SCALE _____

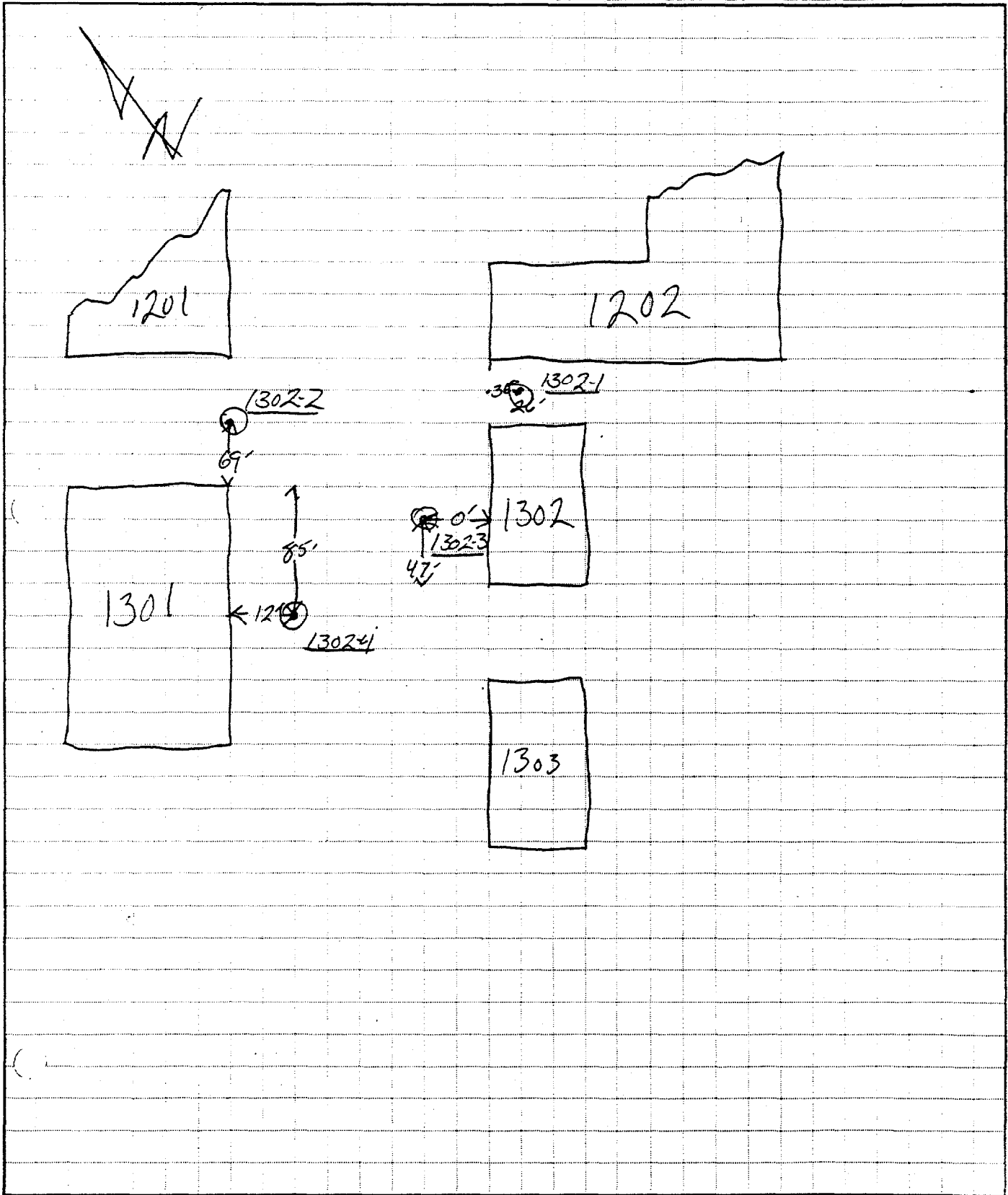

Table B-7. Soil Gas Data For Buildings 1300, 1302,
1101, and 1102.

Sample ID	TCE* (nl/l)+
1300-1	295
1300-2	<10
1300-3	<10
1300-4	<10
1300-5	<10
1300-6	<10
1300-7	46
1300-8	404
1302-1	<10
1302-2	1250
1302-3	<10
1302-4	25
1101-1	<10
1101-2	<10
1101-3	<10
1102-1	442
1102-2	<10
1102-3	<10
1102-4	800

Note: * TCE = Trichloroethene
+ nl/l = nanoliter per liter (parts per billion)

Source: ESE, 1987.

APPENDIX Q

**SUPPLEMENTAL CHARACTERIZATION INVESTIGATION
CHAIN OF CUSTODY FORMS**

Hunter/ESE, Inc. 12-13-90
PROJECT NUMBER

*** FIELD LOGSHEET ***
PROJECT NAME: CAMP LE JUNE

FIELD GROUP: 90151213
LAB COORD. KEVIN MCHUCH

ESE # SITE/STA HAZ? FRACTIONS(CIRCLE) DATE TIME PARAMETER LIST
*1 MB-001 SS SS 12-20-90 1040 hrs

NOTE -CHANGE OR ENTER SITE ID AS NECESSARY; UP TO 9 ALPHANUMERIC CHARACTERS MAY BE USED
-CIRCLE FRACTIONS COLLECTED. ENTER DATE, TIME, FIELD DATA (IF REQUIRED), HAZARD CODE AND NOTES
-HAZARD CODES: I=IGNITABLE C=CORROSIVE R=REACTIVE T=TOXIC WASTE H=OTHER ACUTE HAZARD; IDENTIFY SPECIFICS IF KNOWN
-PLEASE RETURN COMPLETED LOGSHEETS WITH SAMPLES TO Hunter/ESE, Inc.

RELINQUISHED BY: (NAME/ORGANIZATION/DATE/TIME) VIA: REC'D BY (NAME/ORGANIZATION/DATE/TIME)

1 Paul M. Feinberg / ESE, Inc. / 12-20-90 / 1420 hrs Fed Ex. Jeff Whelan 12/21/90 ESE
2
3

SAMPLER: MORE SAMPLES TO BE SHIPPED? NO IF YES, ANTICIPATED # ___ TO SHIP ON ___/___/___
SAMPLE CUSTODIAN: Custody Seals Intact? ___ Samples Iced? ___ Preservations Audited? ___ Problems? ___

Hunter/ESE, Inc. 01-04-91
PROJECT NUMBER 6902021-0001

*** FIELD LOGSHEET ***
PROJECT NAME: CAMP LEJUENE

FIELD GROUP: 90210001
LAB COORD. KEVIN MCHUGH

ESE #	SITE/STA HAZ?	FRACTIONS(CIRCLE)	DATE	TIME	PARAMETER LIST
*127	TB-024	T			
*128	TB-025	T			
*129	TB-026	T			
*130	TB-027	T			
*131	TB-028	T			
*132	TB-029	T			
*133	TB-030	T			
*134	TB-031	T			
*135	TB-032	T			
*136	EB-001	T	Full TCL	1-7-91 12:50	(7 containers) ✓
*137	EB-002	T	Full TCL	1-7-91 14:45	(7 containers) ✓
*138	EB-003	T			
*139	EB-004	T			
*140	EB-005	T			
*141	EB-006	T			
*142	EB-007	T			
*143	EB-008	T			
*144	EB-009	T			

NOTE -CHANGE OR ENTER SITE ID AS NECESSARY; UP TO 9 ALPHANUMERIC CHARACTERS MAY BE USED
-CIRCLE FRACTIONS COLLECTED. ENTER DATE, TIME, FIELD DATA (IF REQUIRED), HAZARD CODE AND NOTES
-HAZARD CODES: I=IGNITABLE C=CORROSIVE R=REACTIVE T=TOXIC WASTE H=OTHER ACUTE HAZARD; IDENTIFY SPECIFICS IF KNOWN
-PLEASE RETURN COMPLETED LOGSHEETS WITH SAMPLES TO Hunter/ESE, Inc.

RELINQUISHED BY: (NAME/ORGANIZATION/DATE/TIME) VIA: REC'D BY (NAME/ORGANIZATION/DATE/TIME)

1 *Kevin Mchugh/ESE* 1-7-91/17:00 *FED EX AIRBILL # 9868702174*

2 *Jeff Williams - ESE* 1/8/91

3

SAMPLER: MORE SAMPLES TO BE SHIPPED? Y IF YES, ANTICIPATED # 5 TO SHIP ON 1/8/91
SAMPLE CUSTODIAN: Custody Seals Intact? Samples Iced? Preservations Audited? Problems?

Hunter/ESE, Inc. 01-04-91
PROJECT NUMBER 6902021-0001

*** FIELD LOGSHEET ***
PROJECT NAME: CAMP LEJUENE

FIELD GROUP: 90210001
LAB COORD. KEVIN MCHUGH

ESE #	SITE/STA	HAZ?	FRACTIONS(CIRCLE)	DATE	TIME	PARAMETER LIST
*199	EB-064		T			
*200	EB-065		T			
*201	EB-066		T			
*202	EB-067		T			
*203	EB-068		T			
*204	MB-001		T			
*205	FB-001		T			
*206	FB-002		T			
*207	DI-001		T	1/7/91	1305	(7 containers) ✓
*208	DI-002		T			
*209	DI-003		T			
*210	DI-004		T			
*211	48TI1		T			
*212	48TI2		T			
*213	48TI3		T			
*214	48TI4		T			
*215	48TI5		T			
*216	48TI6		T			

NOTE -CHANGE OR ENTER SITE ID AS NECESSARY; UP TO 9 ALPHANUMERIC CHARACTERS MAY BE USED
-CIRCLE FRACTIONS COLLECTED. ENTER DATE, TIME, FIELD DATA (IF REQUIRED), HAZARD CODE AND NOTES
-HAZARD CODES: I-IGNITABLE C-CORROSIVE R-REACTIVE T-TOXIC WASTE H-OTHER ACUTE HAZARD; IDENTIFY SPECIFICS IF KNOWN
-PLEASE RETURN COMPLETED LOGSHEETS WITH SAMPLES TO Hunter/ESE, Inc.

RELINQUISHED BY: (NAME/ORGANIZATION/DATE/TIME) VIA: REC'D BY (NAME/ORGANIZATION/DATE/TIME)

1 *M. Kaynes/ESE/1/7/91/1700hrs* Fed Ex Airbill # 9868702174
2 *Jeff Wilson - ESE 1/8/91*
3

SAMPLER: MORE SAMPLES TO BE SHIPPED? Y IF YES, ANTICIPATED # 5 TO SHIP ON 1/8/91
SAMPLE CUSTODIAN: Custody Seals Intact? Samples Iced? Preservations Audited? Problems?

Hunter E, Inc. 01-04-91
PROJECT NUMBER 6902021-0001

*** FIELD LOGSHEET ***
PROJECT NAME: CAMP LEJUENE

FIELD GROUP: 90210001
LAB COORD. KEVIN MCHUGH

ESE #	SITE/STA	HAZ?	FRACTIONS(CIRCLE)	DATE	TIME	PARAMETER LIST
*199	EB-064		T			
*200	EB-065		T			
*201	EB-066		T			
*202	EB-067		T			
*203	EB-068		T			
*204	MB-001		T			
*205	FB-001		T	Full TCL	1/7/91 1540	(7 containers) ✓
*206	FB-002		T			
*207	DI-001		T			
*208	DI-002		T			
*209	DI-003		T			
*210	DI-004		T			
*211	48TI1		T			
*212	48TI2		T			
*213	48TI3		T			
*214	48TI4		T			
*215	48TI5		T			
*216	48TI6		T			

NOTE -CHANCE OR ENTER SITE ID AS NECESSARY; UP TO 9 ALPHANUMERIC CHARACTERS MAY BE USED
-CIRCLE FRACTIONS COLLECTED. ENTER DATE, TIME, FIELD DATA (IF REQUIRED), HAZARD CODE AND NOTES
-HAZARD CODES: I-IGNITABLE C-CORROSIVE R-REACTIVE T-TOXIC WASTE H-OTHER ACUTE HAZARD; IDENTIFY SPECIFICS IF KNOWN
-PLEASE RETURN COMPLETED LOGSHEETS WITH SAMPLES TO Hunter/ESE, Inc.

RELINQUISHED BY: (NAME/ORGANIZATION/DATE/TIME) VIA: REC'D BY (NAME/ORGANIZATION/DATE/TIME)

1 M. Laves / ESE / 1-7/91 / 1700 hrs Fed EX Airbill # 9868702174
2 Jeff Williams 1/8/91 ESC
3

SAMPLER: MORE SAMPLES TO BE SHIPPED? IF YES, ANTICIPATED # 5 TO SHIP ON 1/8/91
SAMPLE CUSTODIAN: Custody Seals Intact? Samples Iced? Preservations Audited? Problems?

Hunter/ESE, Inc. 01-04-91
PROJECT NUMBER 6902021-0001

*** FIELD LOGSHEET ***
PROJECT NAME: CAMP LEJUENE

FIELD GROUP: 90210001
LAB COORD. KEVIN MCHUGH

ESE #	SITE/STA	HAZ?	FRACTIONS(CIRCLE)	DATE	TIME	PARAMETER LIST
*1	HPCW1		T			
*2	HPCW2		T			
*3	HPCW3		T			
*4	HPCW4		T			
*5	HPCW5		T			
*6	HPCW6		T			
*7	HPCW7		T			
*8	HPCW8		T			
*9	HPCW9		T			
*10	HPCW10		T			
*11	HPCW11		T			
*12	HPCW12		T			
*13	HPCW13		T			
*14	HPCW14		T			
*15	HPCW15		T			
*16	HPCW16		T			
*17	<u>HPCW17</u>		full TCL	1/7/91	1210	(7 containers) ✓
*18	HPCW18		T			

NOTE -CHANGE OR ENTER SITE ID AS NECESSARY; UP TO 9 ALPHANUMERIC CHARACTERS MAY BE USED
-CIRCLE FRACTIONS COLLECTED. ENTER DATE, TIME, FIELD DATA (IF REQUIRED), HAZARD CODE AND NOTES
-HAZARD CODES: I=IGNITABLE C=CORROSIVE R=REACTIVE T=TOXIC WASTE H=OTHER ACUTE HAZARD; IDENTIFY SPECIFICS IF KNOWN
-PLEASE RETURN COMPLETED LOGSHEETS WITH SAMPLES TO Hunter/ESE, Inc.

RELINQUISHED BY: (NAME/ORGANIZATION/DATE/TIME) VIA: REC'D BY (NAME/ORGANIZATION/DATE/TIME)

1 *W. Jayus / ESE / 1/7/91 / 1700hrs* Fed Ex Airbill # 9868702174

2

3

Job Whiting - ESE 1/8/91

SAMPLER: MORE SAMPLES TO BE SHIPPED? IF YES, ANTICIPATED # 5 TO SHIP ON 1/8/91
SAMPLE CUSTODIAN: Custody Seals Intact? Samples Iced? Preservations Audited? Problems?

Hunter/ESE, Inc. 01-04-91
PROJECT NUMBER 6902021-0001

*** FIELD LOGSHEET ***
PROJECT NAME: CAMP LEJUENE

FIELD GROUP: 90210001
LAB COORD. KEVIN MCHUGH

ESE #	SITE/STA	HAZ?	FRACTIONS(CIRCLE)	DATE	TIME	PARAMETER LIST
*91	69SW5-1		T			
*92	69SW5-2		T			
*93	GWDUP1		T			
*94	GWDUP2		T			
*95	GWDUP3		T			
*96	GWDUP4		T			
*97	GWDUP5		T			
*98	GWDUP6		T			
*99	GWDUP7		T			
*100	GWDUP8		T			
*101	GWDUP9		T			
*102	SWDUP1		T			
*103	SWDUP2		T			
*104	<u>TB-001</u>		T	TCL VOA	1/7/91	1245 (3 containers) ✓
*105	TB-002		T			
*106	TB-003		T			
*107	TB-004		T			
*108	TB-005		T			

NOTE -CHANGE OR ENTER SITE ID AS NECESSARY; UP TO 9 ALPHANUMERIC CHARACTERS MAY BE USED
-CIRCLE FRACTIONS COLLECTED. ENTER DATE, TIME, FIELD DATA (IF REQUIRED), HAZARD CODE AND NOTES
-HAZARD CODES: I=IGNITABLE C=CORROSIVE R=REACTIVE T=TOXIC WASTE H=OTHER ACUTE HAZARD; IDENTIFY SPECIFICS IF KNOWN
-PLEASE RETURN COMPLETED LOGSHEETS WITH SAMPLES TO Hunter/ESE, Inc.

RELINQUISHED BY: (NAME/ORGANIZATION/DATE/TIME) VIA: REC'D BY (NAME/ORGANIZATION/DATE/TIME)

1 M. Baynes / ESE / 1/7/91 / 1700 hrs FedEx Airbill # 9868702174

2

3

Jeff Whang - ESE 1/8/91

SAMPLER: MORE SAMPLES TO BE SHIPPED? IF YES, ANTICIPATED # 5 TO SHIP ON 1/8/91

SAMPLE CUSTODIAN: Custody Seals Intact? Samples Iced? Preservations Audited? Problems?

Hunter/ESE, Inc. 01-04-91
PROJECT NUMBER 6902021-0001

*** FIELD LOGSHEET ***
PROJECT NAME: CAMP LEJUENE

FIELD GROUP: 90210001
LAB COORD. KEVIN MCHUGH

ESE #	SITE/STA	HAZ?	FRACTIONS(CIRCLE)	DATE	TIME	PARAMETER LIST
*1	HPGW1		T			
*2	HPGW2		T			
*3	HPGW3		T			
*4	HPGW4		T			
*5	HPGW5		T			
*6	HPGW6		T			
*7	HPGW7		T			
*8	HPGW8		T	1-8-91	1330	(7 containers)
*9	HPGW9		T			
*10	HPGW10		T			
*11	HPGW11		T			
*12	HPGW12		T			
*13	HPGW13		T			
*14	HPGW14		T			
*15	HPGW15		T			
*16	HPGW16		T			
*17	HPGW17		T			
*18	HPGW18		T			

NOTE -CHANGE OR ENTER SITE ID AS NECESSARY; UP TO 9 ALPHANUMERIC CHARACTERS MAY BE USED
-CIRCLE FRACTIONS COLLECTED. ENTER DATE, TIME, FIELD DATA (IF REQUIRED), HAZARD CODE AND NOTES
-HAZARD CODES: I-IGNITABLE C-CORROSIVE R-REACTIVE T-TOXIC WASTE H-OTHER ACUTE HAZARD; IDENTIFY SPECIFICS IF KNOWN
-PLEASE RETURN COMPLETED LOGSHEETS WITH SAMPLES TO Hunter/ESE, Inc.

RELINQUISHED BY: (NAME/ORGANIZATION/DATE/TIME)

VIA:

REC'D BY (NAME/ORGANIZATION/DATE/TIME)

1 M. Sayre / ESE / 1-8-91 / 1700

FedEx Airbill # 9868702299

2

Off loading - ESE 1/9/91 10:55

3

SAMPLER: MORE SAMPLES TO BE SHIPPED? IF YES, ANTICIPATED # 10 TO SHIP ON 1/9/91
CUSTODIAN: Custody Seals Intact? Samples Iced? Preservations Audited? Problems?

Hunter/ESE, Inc. 01-04-91
PROJECT NUMBER 6902021-0001

*** FIELD LOGSHEET ***
PROJECT NAME: CAMP LEJUENE

FIELD GROUP: 90210001
LAB COORD. KEVIN MCHUGH

ESE #	SITE/STA	HAZ?	FRACTIONS(CIRCLE)	DATE	TIME	PARAMETER LIST
*1	HPGW1		T			
*2	HPGW2		T			
*3	HPGW3		T			
*4	HPGW4		T			
*5	HPGW5		T			
*6	HPGW6		T			
*7	HPGW7		T			
*8	HPGW8		T			
*9	HPGW9		T			
*10	HPGW10		T			
*11	HPGW11		T			
*12	HPGW12		T			
*13	HPGW13		T			
*14	HPGW14		T			
*15	HPGW15		T	1-8-91		(7 containers)
*16	HPGW16		T			
*17	HPGW17		T			
*18	HPGW18		T			

NOTE -CHANGE OR ENTER SITE ID AS NECESSARY; UP TO 9 ALPHANUMERIC CHARACTERS MAY BE USED
-CIRCLE FRACTIONS COLLECTED. ENTER DATE, TIME, FIELD DATA (IF REQUIRED), HAZARD CODE AND NOTES
-HAZARD CODES: I-IGNITABLE C-CORROSIVE R-REACTIVE T-TOXIC WASTE H-OTHER ACUTE HAZARD: IDENTIFY SPECIFICS IF KNOWN
-PLEASE RETURN COMPLETED LOGSHEETS WITH SAMPLES TO Hunter/ESE, Inc.

RELINQUISHED BY: (NAME/ORGANIZATION/DATE/TIME)

VIA:

REC'D BY (NAME/ORGANIZATION/DATE/TIME)

1 M Lape / ESE / 1-8-91 / 1700

Fed Ex Air bill # 9868702244

2

Jeff Leasing - ESE 1/9/91 10:55

3

SAMPLER: MORE SAMPLES TO BE SHIPPED? IF YES, ANTICIPATED # 10 TO SHIP ON 1/9/91
CUSTODIAN: Custody Seals Intact? Samples Iced? Preservations Audited? Problems?

Hunter/ESE, Inc. 01-04-91
PROJECT NUMBER 6902021-0001

*** FIELD LOGSHEET ***
PROJECT NAME: CAMP LEJUENE

FIELD GROUP: 90210001
LAB COORD. KEVIN MCHUGH

ESE #	SITE/STA HAZ?	FRACTIONS(CIRCLE)	DATE	TIME	PARAMETER LIST
*91	69SW5-1	T			
*92	69SW5-2	T			
*93	GWDUP1	T full TCL	1-8-91	1200	(7 containers)
*94	GWDUP2	T			
*95	GWDUP3	T			
*96	GWDUP4	T			
*97	GWDUP5	T			
*98	GWDUP6	T			
*99	GWDUP7	T			
*100	GWDUP8	T			
*101	GWDUP9	T			
*102	SWDUP1	T			
*103	SWDUP2	T			
*104	TB-001	T			
*105	TB-002	T TCL VOA	1-8-91	0735	(3 containers)
*106	TB-003	T			
*107	TB-004	T			
*108	TB-005	T			

NOTE -CHANGE OR ENTER SITE ID AS NECESSARY; UP TO 9 ALPHANUMERIC CHARACTERS MAY BE USED
-CIRCLE FRACTIONS COLLECTED. ENTER DATE, TIME, FIELD DATA (IF REQUIRED), HAZARD CODE AND NOTES
-HAZARD CODES: I-IGNITABLE C-CORROSIVE R-REACTIVE T-TOXIC WASTE H-OTHER ACUTE HAZARD; IDENTIFY SPECIFICS IF KNOWN
-PLEASE RETURN COMPLETED LOGSHEETS WITH SAMPLES TO Hunter/ESE, Inc.

RELINQUISHED BY: (NAME/ORGANIZATION/DATE/TIME) VIA: REC'D BY (NAME/ORGANIZATION/DATE/TIME)

1 M. Jaynes / ESE / 1-8-91 Red Ex Arbill # 9868 702244
2
3 Jeff Leung - ESE
1/9/91
10.55

SAMPLER: MORE SAMPLES TO BE SHIPPED? IF YES, ANTICIPATED # 10 TO SHIP ON 1/9/91
SAMPLE CUSTODIAN: Custody Seals Intact? Samples Iced? Preservations Audited? Problems?

Hunter/ESE, Inc. 01-04-91
PROJECT NUMBER 6902021-0001

*** FIELD LOGSHEET ***
PROJECT NAME: CAMP LEJUENE

FIELD GROUP: 90210001
LAB COORD. KEVIN MCHUGH

ESE #	SITE/STA	HAZ?	FRACTIONS(CIRCLE)	DATE	TIME	PARAMETER LIST
*19	HPGW19		T			
*20	HPGW20		T			
*21	HPGW21		T			
*22	HPGW22		T			
*23	HPGW23		T			
*24	HPGW24		T	1-8-91	1615	Full TCL 7 containers
*25	HPGW25		T			
*26	HPGW26		T			
*27	HPGW27		T			
*28	HPGW28		T			
*29	HPGW29		T			
*30	22GW1		T			
*31	22GW2		T			
*32	21GW1		T			
*33	HPGW9-2		T			
*34	HPGW17-2		T			
*35	HPGW24-2		T	1-8-91	1550	Full TCL 7 containers
*36	HPGW30-2		T			

NOTE -CHANGE OR ENTER SITE ID AS NECESSARY; UP TO 9 ALPHANUMERIC CHARACTERS MAY BE USED
-CIRCLE FRACTIONS COLLECTED. ENTER DATE, TIME, FIELD DATA (IF REQUIRED), HAZARD CODE AND NOTES
-HAZARD CODES: I-IGNITABLE C-CORROSIVE R-REACTIVE T-TOXIC WASTE H-OTHER ACUTE HAZARD; IDENTIFY SPECIFICS IF KNOWN
-PLEASE RETURN COMPLETED LOGSHEETS WITH SAMPLES TO Hunter/ESE, Inc.

RELINQUISHED BY: (NAME/ORGANIZATION/DATE/TIME) VIA: REC'D BY (NAME/ORGANIZATION/DATE/TIME)

1 M. Sawyer / ESE / 1-8-91 / 1700 Fed Ex Airbill # 9868702244

2

3

Jeff Williams - ESE - 1/9/91
10:55

ALERT: MORE SAMPLES TO BE SHIPPED? IF YES, ANTICIPATED # 10 TO SHIP ON 1/9/91
CUSTODIAN: Custody Seals Intact? Samples Iced? Preservations Audited? Problems?

Hunter, Inc. 01-04-91
PROJECT NUMBER 6902021-0001

*** FIELD LOGSHEET ***
PROJECT NAME: CAMP LEJUENE

FIELD GROUP: 90210001
LAB COORD. KEVIN MCHUGH

ESE #	SITE/STA	HAZ?	FRACTIONS(CIRCLE)	DATE	TIME	PARAMETER LIST
*19	HPGW19		T			
*20	HPGW20		T			
*21	HPGW21		T			
*22	HPGW22		T			
*23	HPGW23		T			
*24	HPGW24		T			
*25	HPGW25		T			
*26	HPGW26		T			
*27	HPGW27		T			
*28	HPGW28		T			
*29	HPGW29		T			
*30	22GW1		T			
*31	22GW2		T			
*32	21GW1		T			
*33	HPGW9-2		T	1-8-91	1200	(7 containers)
*34	HPGW17-2		T	1-8-91	0941	(7 containers)
*35	HPGW24-2		T			
*36	HPGW30-2		T			

NOTE -CHANGE OR ENTER SITE ID AS NECESSARY; UP TO 9 ALPHANUMERIC CHARACTERS MAY BE USED
-CIRCLE FRACTIONS COLLECTED. ENTER DATE, TIME, FIELD DATA (IF REQUIRED), HAZARD CODE AND NOTES
-HAZARD CODES: I-IGNITABLE C-CORROSIVE R-REACTIVE T-TOXIC WASTE H-OTHER ACUTE HAZARD; IDENTIFY SPECIFICS IF KNOWN
-PLEASE RETURN COMPLETED LOGSHEETS WITH SAMPLES TO Hunter/ESE, Inc.

RELINQUISHED BY: (NAME/ORGANIZATION/DATE/TIME) VIA: REC'D BY (NAME/ORGANIZATION/DATE/TIME)

1 W. Layton / ESE / 1-8-91 / 1700

Fed EX Arkhill # 9868702244

2

Jeff Whelan - ESE 1/9/91 10:55

3

PLER: MORE SAMPLES TO BE SHIPPED? IF YES, ANTICIPATED # 10 TO SHIP ON 1/9/91

CUSTODIAN: Custody Seals Intact? Samples Iced? Preservations Audited? Problems?

Hunter/ESE, Inc. 01-07-91
PROJECT NUMBER 6902021-C001

*** FIELD LOGSHEET ***
PROJECT NAME: CAMP LEJUENE

FIELD GROUP: 90210001
LAB COORD. KEVIN MCHUGH

ESE # SITE/STA HAZ? FRACTIONS(CIRCLE) DATE TIME PARAMETER LIST
V V V W W N N S S

GWDUP 3 / (V)(V)(V)(W)(W)(N)(N)(S)(S) 1-9-91 1130 (ms/msD)

V V V W W N N S S

V V V W W N N S S

V V V W W N N S S

V V V W W N N S S

V V V W W N N S S

V V V W W N N S S

V V V W W N N S S

V V V W W N N S S

V V V W W N N S S

V V V W W N N S S

V V V W W N N S S

V V V W W N N S S

NOTE -CHANGE OR ENTER SITE ID AS NECESSARY; UP TO 9 ALPHANUMERIC CHARACTERS MAY BE USED
-CIRCLE FRACTIONS COLLECTED. ENTER DATE, TIME, FIELD DATA (IF REQUIRED), HAZARD CODE AND NOTES
-HAZARD CODES: I-IGNITABLE C-CORROSIVE R-REACTIVE T-TOXIC WASTE H-OTHER ACUTE HAZARD; IDENTIFY
-PLEASE RETURN COMPLETED LOGSHEETS WITH SAMPLES TO Hunter/ESE, Inc.

RELINQUISHED BY: (NAME/ORGANIZATION/DATE/TIME) VIA: REC'D BY (NAME/ORGANIZATION/DATE/TIME)

1 M. Sayre /ESE / 1-9-91 / 1700

Fed Ex Arbill# 9868702185

2

3

Sub. Feltz - ESK
1/10/91

SAMPLER: MORE SAMPLES TO BE SHIPPED? Y IF YES, ANTICIPATED # 10 TO SHIP ON 1/10/91

Hunter/ESE, Inc. 01-07-91
PROJECT NUMBER 6902021-0001

*** FIELD LOGSHEET ***
PROJECT NAME: CAMP LEJUENE

FIELD GROUP: 90210001
LAB COORD. KEVIN MCHUGH

ESE #	SITE/STA	HAZ?	FRACTIONS(CIRCLE)								DATE	TIME	PARAMETER LIST	
			V	V	V	W	W	N	N	S				S
TB-003	✓		(V)	(V)	(V)	W	W	N	N	S	S	1-9-91 0725	TCL VOA	(3 containers)
HPGW11	✓		(V)	(V)	(V)	(W)	(W)	(N)	N	(S)	S	1-9-91 1520	full TCL	(7 containers)
HPGW9-3	✓		(V)	(V)	(V)	(W)	(W)	(N)	N	(S)	S	1-9-91 1605	"	"
HPGW7	✓		(V)	(V)	(V)	(W)	(W)	(N)	N	(S)	S	1-9-91 1630	"	"
			V	V	V	W	W	N	N	S	S			
			V	V	V	W	W	N	N	S	S			
			V	V	V	W	W	N	N	S	S			
			V	V	V	W	W	N	N	S	S			
			V	V	V	W	W	N	N	S	S			
			V	V	V	W	W	N	N	S	S			
			V	V	V	W	W	N	N	S	S			
			V	V	V	W	W	N	N	S	S			
			V	V	V	W	W	N	N	S	S			

NOTE -CHANGE OR ENTER SITE ID AS NECESSARY; UP TO 9 ALPHANUMERIC CHARACTERS MAY BE USED
-CIRCLE FRACTIONS COLLECTED. ENTER DATE, TIME, FIELD DATA (IF REQUIRED), HAZARD CODE AND NOTES
-HAZARD CODES: I=IGNITABLE C=CORROSIVE R=REACTIVE T=TOXIC WASTE H=OTHER ACUTE HAZARD; IDENTIFY
-PLEASE RETURN COMPLETED LOGSHEETS WITH SAMPLES TO Hunter/ESE, Inc.

RELINQUISHED BY: (NAME/ORGANIZATION/DATE/TIME) VIA: REC'D BY (NAME/ORGANIZATION/DATE/TIME)

1 M Jaynes / ESE / 1-9-91 / 1700 Fed Ex # 9868702185

Jeff Usher - ESE
1/10/91

SAMPLER: MORE SAMPLES TO BE SHIPPED? IF YES, ANTICIPATED # 10 TO SHIP ON 1/10/91

Hunter/ESE, Inc. 01-07-91
PROJECT NUMBER 6902021-0001

*** FIELD LOGSHEET ***
PROJECT NAME: CAMP LEJUENE

FIELD GROUP: 90210001
LAB COORD. KEVIN MCHUGH

ES #	SI	STA	HAZ?	FRACTIONS(CIRCLE)	DATE	TIME	PARAMETER LIST
				V V V W W N N S S	1-9-91	1605	full TCL (ms/msd) (14 containers)
				V V V W W N N S S			
				V V V W W N N S S			
				V V V W W N N S S			
				V V V W W N N S S			
				V V V W W N N S S			
				V V V W W N N S S			
				V V V W W N N S S			
				V V V W W N N S S			
				V V V W W N N S S			
				V V V W W N N S S			
				V V V W W N N S S			
				V V V W W N N S S			
				V V V W W N N S S			
				V V V W W N N S S			

NOTE -CHANGE OR ENTER SITE ID AS NECESSARY; UP TO 9 ALPHANUMERIC CHARACTERS MAY BE USED
-CIRCLE FRACTIONS COLLECTED. ENTER DATE, TIME, FIELD DATA (IF REQUIRED), HAZARD CODE AND NOTES
-HAZARD CODES: I=IGNITABLE C=CORROSIVE R=REACTIVE T=TOXIC WASTE H=OTHER ACUTE HAZARD; IDENTIFY
-PLEASE RETURN COMPLETED LOGSHEETS WITH SAMPLES TO Hunter/ESE, Inc.

RELINQUISHED BY: (NAME/ORGANIZATION/DATE/TIME) VIA: REC'D BY (NAME/ORGANIZATION/DATE/TIME)

1 M. Hayes/ESE/1-9-91/1700

Fed Ex Advill # 9868702185

Jeff Liting-ESE
1/10/91

SAMPLER: MORE SAMPLES TO BE SHIPPED? IF YES, ANTICIPATED # 10 TO SHIP ON 1/10/91

Hunter/ESE, Inc. 01-07-91
PROJECT NUMBER 6902021-0001

*** FIELD LOGSHEET ***
PROJECT NAME: CAMP LEJUENE

FIELD GROUP: 90210001
LAB COORD. KEVIN MCHUGH

ESE #	SITE/STA	HAZ?		FRACTIONS(CIRCLE)						DATE	TIME	PARAMETER LIST		
		V	V	V	W	W	N	N	S				S	
HPGW6		(V)	(V)	(V)	(W)	(W)	(N)	N	(S)	S	1-10-91	0925	Full TCL	(7 containers)
HPGW14	-	(V)	(V)	(V)	(W)	(W)	(N)	N	(S)	S	"	1215	"	(")
TB004	✓	(V)	(V)	(V)	W	W	N	N	S	S	"	0635	TCL VOA	(3 containers)
HPGW30-3	✓	(V)	(V)	(V)	(W)	(W)	(N)	N	(S)	S	"	1311	Full TCL	(7 containers)
		V	V	V	W	W	N	N	S	S				
		V	V	V	W	W	N	N	S	S				
		V	V	V	W	W	N	N	S	S				
		V	V	V	W	W	N	N	S	S				
		V	V	V	W	W	N	N	S	S				
		V	V	V	W	W	N	N	S	S				
		V	V	V	W	W	N	N	S	S				
		V	V	V	W	W	N	N	S	S				
		V	V	V	W	W	N	N	S	S				

NOTE -CHANGE OR ENTER SITE ID AS NECESSARY; UP TO 9 ALPHANUMERIC CHARACTERS MAY BE USED
-CIRCLE FRACTIONS COLLECTED. ENTER DATE, TIME, FIELD DATA (IF REQUIRED), HAZARD CODE AND NOTES
-HAZARD CODES: I=IGNITABLE C=CORROSIVE R=REACTIVE T=TOXIC WASTE H=OTHER ACUTE HAZARD; IDENTIFY
-PLEASE RETURN COMPLETED LOGSHEETS WITH SAMPLES TO Hunter/ESE, Inc.

RELINQUISHED BY: (NAME/ORGANIZATION/DATE/TIME) VIA: REC'D BY (NAME/ORGANIZATION/DATE/TIME)

1 M. Baynes/ESE/1-10-91/1700

Fed Ex Airbill # 9868702196

Jeff Wherry-ESE
1/11/91

SAMPLER: MORE SAMPLES TO BE SHIPPED? IF YES, ANTICIPATED # 10 TO SHIP ON 1-11-91

Hunter/ESE, Inc. 01-07-91
PROJECT NUMBER 6902021-0001

*** FIELD LOGSHEET ***
PROJECT NAME: CAMP LEJUENE

FIELD GROUP: 90210001
LAB COORD. KEVIN MCHUGH

ESE #	SITE/STA	HAZ?	FRACTIONS(CIRCLE)					DATE	TIME	PARAMETER LIST				
			V	V	V	W	W	N	N	S	S			
HPGW30-2			(V)	(V)	(V)	(W)	(W)	(N)	N	(S)	S	1-10-91	1115	20/10 Full TCL (7 containers)
GWDUP4			(V)	(V)	(V)	(W)	(W)	(N)	(N)	(S)	(S)	"	1115	" (14 containers) (MS/MSD)
			V	V	V	W	W	N	N	S	S			
			V	V	V	W	W	N	N	S	S			
			V	V	V	W	W	N	N	S	S			
			V	V	V	W	W	N	N	S	S			
			V	V	V	W	W	N	N	S	S			
			V	V	V	W	W	N	N	S	S			
			V	V	V	W	W	N	N	S	S			
			V	V	V	W	W	N	N	S	S			
			V	V	V	W	W	N	N	S	S			
			V	V	V	W	W	N	N	S	S			
			V	V	V	W	W	N	N	S	S			
			V	V	V	W	W	N	N	S	S			
			V	V	V	W	W	N	N	S	S			

NOTE -CHANGE OR ENTER SITE ID AS NECESSARY; UP TO 9 ALPHANUMERIC CHARACTERS MAY BE USED
-CIRCLE FRACTIONS COLLECTED. ENTER DATE, TIME, FIELD DATA (IF REQUIRED), HAZARD CODE AND NOTES
-HAZARD CODES: I=IGNITABLE C=CORROSIVE R=REACTIVE T=TOXIC WASTE H=OTHER ACUTE HAZARD; IDENTIFY
-PLEASE RETURN COMPLETED LOGSHEETS WITH SAMPLES TO Hunter/ESE, Inc.

RELINQUISHED BY: (NAME/ORGANIZATION/DATE/TIME) VIA: REC'D BY (NAME/ORGANIZATION/DATE/TIME)

1 M Saunders /ESE/1-10-91/1700

Fed Ex Airbill # 9868702196 Jeff Whelan -ESC

2

1/11/91

3

SAMPLER: MORE SAMPLES TO BE SHIPPED? Y IF YES, ANTICIPATED # 10 TO SHIP ON 1.11.191

Hunter/ESE, Inc. 01-07-91
PROJECT NUMBER 6902021-0001

*** FIELD LOGSHEET ***
PROJECT NAME: CAMP LEJUENE

FIELD GROUP: 90210001
LAB COORD. KEVIN MCHUGH

* SITE/STA HAZ?	FRACTIONS(CIRCLE)								DATE	TIME	PARAMETER LIST	
	V	V	V	W	W	N	N	S				S
5HPGW5	(V)	(V)	(V)	(W)	(W)	(N)	N	(S)	S	1-10-91	1615	FULL TCL (7 containers)
	V	V	V	W	W	N	N	S	S			
	V	V	V	W	W	N	N	S	S			
	V	V	V	W	W	N	N	S	S			
	V	V	V	W	W	N	N	S	S			
	V	V	V	W	W	N	N	S	S			
	V	V	V	W	W	N	N	S	S			
	V	V	V	W	W	N	N	S	S			
	V	V	V	W	W	N	N	S	S			
	V	V	V	W	W	N	N	S	S			
	V	V	V	W	W	N	N	S	S			
	V	V	V	W	W	N	N	S	S			
	V	V	V	W	W	N	N	S	S			
	V	V	V	W	W	N	N	S	S			
	V	V	V	W	W	N	N	S	S			

NOTE -CHANGE OR ENTER SITE ID AS NECESSARY; UP TO 9 ALPHANUMERIC CHARACTERS MAY BE USED
-CIRCLE FRACTIONS COLLECTED. ENTER DATE, TIME, FIELD DATA (IF REQUIRED), HAZARD CODE AND NOTES
-HAZARD CODES: I=IGNITABLE C=CORROSIVE R=REACTIVE T=TOXIC WASTE H=OTHER ACUTE HAZARD; IDENTIFY
-PLEASE RETURN COMPLETED LOGSHEETS WITH SAMPLES TO Hunter/ESE, Inc.

RELINQUISHED BY: (NAME/ORGANIZATION/DATE/TIME) VIA: REC'D BY (NAME/ORGANIZATION/DATE/TIME)

1 M. Sayre / ESE / 1-10-91 / 1700 Fed Ex Arbill # 9868702196

2

3

SAMPLER: MORE SAMPLES TO BE SHIPPED? IF YES, ANTICIPATED # 10 TO SHIP ON 1/11/91

Hunter ESE, Inc. 01-07-91
PROJECT NUMBER 6902021-0001

*** FIELD LOGSHEET ***
PROJECT NAME: CAMP LEJUENE

FIELD GROUP: 90210001
LAB COORD. KEVIN MCHUGH

ESE #	SITE/STA	HAZ?	FRACTIONS (CIRCLE)					DATE	TIME	PARAMETER LIST				
HP6W4-2			V	V	V	W	W	N	N	S	S	1-11-91	0920	Full TCL (7 containers)
			V	V	V	W	W	N	N	S	S			
			V	V	V	W	W	N	N	S	S			
			V	V	V	W	W	N	N	S	S			
			V	V	V	W	W	N	N	S	S			
			V	V	V	W	W	N	N	S	S			
			V	V	V	W	W	N	N	S	S			
			V	V	V	W	W	N	N	S	S			
			V	V	V	W	W	N	N	S	S			
			V	V	V	W	W	N	N	S	S			
			V	V	V	W	W	N	N	S	S			
			V	V	V	W	W	N	N	S	S			
			V	V	V	W	W	N	N	S	S			
			V	V	V	W	W	N	N	S	S			
			V	V	V	W	W	N	N	S	S			
			V	V	V	W	W	N	N	S	S			

NOTE - CHANGE OR ENTER SITE ID AS NECESSARY; UP TO 9 ALPHANUMERIC CHARACTERS MAY BE USED
- CIRCLE FRACTIONS COLLECTED. ENTER DATE, TIME, FIELD DATA (IF REQUIRED), HAZARD CODE AND NOTES
- HAZARD CODES: I=IGNITABLE C=CORROSIVE R=REACTIVE T=TOXIC WASTE H=OTHER ACUTE HAZARD; IDENTIFY
- PLEASE RETURN COMPLETED LOGSHEETS WITH SAMPLES TO Hunter/ESE, Inc.

RELINQUISHED BY: (NAME/ORGANIZATION/DATE/TIME) VIA: REC'D BY (NAME/ORGANIZATION/DATE/TIME)
1 F. Khama/ESE/1-11-91 1700 Fed ex airbill 9868702200
2 J. Khama-ESE 1/12/91
3

PLER: MORE SAMPLES TO BE SHIPPED? IF YES, ANTICIPATED # 10 TO SHIP ON 1/12/91

Hunter/ESE, Inc. 01-07-91
PROJECT NUMBER 6902021-0001

*** FIELD LOGSHEET ***
PROJECT NAME: CAMP LEJUENE

FIELD GROUP: 90210001
LAB COORD. KEVIN MCHUGH

ESE #	SITE/STA	HAZ?	FRACTIONS (CIRCLE)	DATE	TIME	PARAMETER LIST
HPGW4	✓	(V)(V)(V)	(W)(W)(N) N (S) S	1-11-91	0900	Full TCL (7 containers)
Dup 5	✓	(V)(V)(V)	(W)(W)(N) N (S) S	"	"	" (14 containers) (MS/MSD)
HPGW19	✓	(V)(V)(V)	(W)(W)(N) N (S) S	1-11-91	1150	Full TCL (7 containers)
HPGW4-3		(V)(V)(V)	(W)(W)(N) N (S) S	1-11-91	1215	Full TCL (7 containers)
		V V V	W W N N S S			
		V V V	W W N N S S			
		V V V	W W N N S S			
		V V V	W W N N S S			
		V V V	W W N N S S			
		V V V	W W N N S S			
		V V V	W W N N S S			
		V V V	W W N N S S			
		V V V	W W N N S S			
		V V V	W W N N S S			
		V V V	W W N N S S			
		V V V	W W N N S S			

NOTE -CHANGE OR ENTER SITE ID AS NECESSARY; UP TO 9 ALPHANUMERIC CHARACTERS MAY BE USED
-CIRCLE FRACTIONS COLLECTED. ENTER DATE, TIME, FIELD DATA (IF REQUIRED), HAZARD CODE AND NOTES
-HAZARD CODES: I=IGNITABLE C=CORROSIVE R=REACTIVE T=TOXIC WASTE H=OTHER ACUTE HAZARD: IDENTIFY
-PLEASE RETURN COMPLETED LOGSHEETS WITH SAMPLES TO Hunter/ESE, Inc.

RELINQUISHED BY: (NAME/ORGANIZATION/DATE/TIME) VIA: REC'D BY (NAME/ORGANIZATION/DATE/TIME)

1 *Don Case I/ESE* 1-11-91 1800 Fed Ex 9868702200

2

3

SAMPLER: MORE SAMPLES TO BE SHIPPED? IF YES, ANTICIPATED # 6 TO SHIP ON 1-12-91

Jeff Whelan ESE 1/12/91

Hunter/ESE, Inc. 01-07-91
PROJECT NUMBER 6902021-0001

*** FIELD LOGSHEET ***
PROJECT NAME: CAMP LEJUENE

FIELD GROUP: 90210001
LAB COORD. KEVIN MCHUGH

ESE #	SITE/STA HAZ?	FRACTIONS (CIRCLE)	DATE	TIME	PARAMETER LIST
HPGW13	✓	(V) (V) (W) (W) (N) (N) (S) (S)	1-12-91	0915	Full TCL (7 containers)
HPGW20	✓	(V) (V) (V) (W) (W) (N) (N) (S) (S)	1-12-91	1015	Full TCL (7 containers)
HPGW29	✓	(V) (V) (V) (W) (W) (N) (N) (S) (S)	1-12-91	1130	Full TCL (7 containers)
TB005	✓	(V) (V) (V) (W) (W) (N) (N) (S) (S)	1-11-91	0635	TCL VOA (3 containers)
TB006	✓	(V) (V) (V) (W) (W) (N) (N) (S) (S)	1-12-91	0715	TCL VOA (3 containers)
HPGW32-2	✓	(V) (V) (V) (W) (W) (N) (N) (S) (S)	1-12-91	1100	Full TCL (7 containers)
HPGW32-3	✓	(V) (V) (V) (W) (W) (N) (N) (S) (S)	1-12-91	1030	Full TCL (7 containers)
		V V V W W N N S S			
		V V V W W N N S S			
		V V V W W N N S S			
		V V V W W N N S S			
		V V V W W N N S S			
		V V V W W N N S S			
		V V V W W N N S S			

NOTE -CHANGE OR ENTER SITE ID AS NECESSARY; UP TO 9 ALPHANUMERIC CHARACTERS MAY BE USED
-CIRCLE FRACTIONS COLLECTED. ENTER DATE, TIME, FIELD DATA (IF REQUIRED), HAZARD CODE AND NOTES
-HAZARD CODES: I=IGNITABLE C=CORROSIVE R=REACTIVE T=TOXIC WASTE H=OTHER ACUTE HAZARD; IDENTIFY
-PLEASE RETURN COMPLETED LOGSHEETS WITH SAMPLES TO Hunter/ESE, Inc.

RELINQUISHED BY: (NAME/ORGANIZATION/DATE/TIME) VIA: REC'D BY (NAME/ORGANIZATION/DATE/TIME)

1 K. Klama / ESE / 1-12/91 / 1230 Fed X bill # 986870221
2
3 1/14/91 Jeff Klama ESE

SAMPLER: MORE SAMPLES TO BE SHIPPED? IF YES, ANTICIPATED # 10 TO SHIP ON 1/14/91

Hunter/ESE, Inc. 01-07-91
PROJECT NUMBER 6902021-0001

*** FIELD LOGSHEET ***
PROJECT NAME: CAMP LEJUENE

FIELD GROUP: 90210001
LAB COORD. KEVIN MCHUGH

ESE # SITE/STA HAZ? FRACTIONS(CIRCLE)

DATE TIME PARAMETER LIST

695W 1 ✓ V V W N N S S

1-16-91 1130 Full TCL

696W 1 ✓ V V V W W N N S S

1-16-91 1145 Full TCL

TB009 ✓ V V V W N N S S

1-16-91 0735 VOA Full TCL

WSP001 V V V W W N N S S

1-16-91 1530 Full TCL EG

WSP002 V V V W W N N S S

1-16-91 1535 Full TCL

V V V W W N N S S

V V V W W N N S S

V V V W W N N S S

V V V W W N N S S

V V V W W N N S S

V V V W W N N S S

V V V W W N N S S

V V V W W N N S S

V V V W W N N S S

NOTE -CHANCE OR ENTER SITE ID AS NECESSARY; UP TO 9 ALPHANUMERIC CHARACTERS MAY BE USED
-CIRCLE FRACTIONS COLLECTED. ENTER DATE, TIME, FIELD DATA (IF REQUIRED), HAZARD CODE AND NOTES
-HAZARD CODES: I=IGNITABLE C=CORROSIVE R=REACTIVE T=TOXIC WASTE H=OTHER ACUTE HAZARD; IDENTIFY
-PLEASE RETURN COMPLETED LOGSHEETS WITH SAMPLES TO Hunter/ESE, Inc.

RELINQUISHED BY: (NAME/ORGANIZATION/DATE/TIME)

VIA:

REC'D BY (NAME/ORGANIZATION/DATE/TIME)

1 Eric Carlson/ESE/1-16-91/1700

FEDEX FEDEX 9868702012

2

Jeff Whelan ESE 1/17/91

MORE SAMPLES TO BE SHIPPED? IF YES, ANTICIPATED # 7 TO SHIP ON 1/17/91

Hunter/ESE, Inc. 01-07-91
PROJECT NUMBER 6902021-0001

*** FIELD LOGSHEET ***
PROJECT NAME: CAMP LEJUENE

FIELD GROUP: 90210001
LAB COORD. KEVIN MCHUGH

ESE #	SITE/STA HAZ?	FRACTIONS (CIRCLE)	DATE	TIME	PARAMETER LIST
HPGW2	✓	V V V W W N N S S	1-16-91	1030	Full TCL (7 containers)
HPGW3	✓	V V V W W N N S S	1-16-91	0940	Full TCL (7 containers)
HPGW1	✓	V V V W W N N S S	1-16-91	1500	Full TCL (7 containers)
		V V V W W N N S S			
		V V V W W N N S S			
		V V V W W N N S S			
		V V V W W N N S S			
		V V V W W N N S S			
		V V V W W N N S S			
		V V V W W N N S S			
		V V V W W N N S S			
		V V V W W N N S S			
		V V V W W N N S S			
		V V V W W N N S S			
		V V V W W N N S S			

NOTE -CHANGE OR ENTER SITE ID AS NECESSARY; UP TO 9 ALPHANUMERIC CHARACTERS MAY BE USED
-CIRCLE FRACTIONS COLLECTED. ENTER DATE, TIME, FIELD DATA (IF REQUIRED), HAZARD CODE AND NOTES
-HAZARD CODES: I=IGNITABLE C=CORROSIVE R=REACTIVE T=TOXIC WASTE H=OTHER ACUTE HAZARD; IDENTIFY
-PLEASE RETURN COMPLETED LOGSHEETS WITH SAMPLES TO Hunter/ESE, Inc.

RELINQUISHED BY: (NAME/ORGANIZATION/DATE/TIME) VIA: REC'D BY (NAME/ORGANIZATION/DATE/TIME)
1 K. Klems / ESE / 1-16-91 / 1700 Fedex Airbill # 9868702071
2

MORE SAMPLES TO BE SHIPPED? IF YES, ANTICIPATED # 10 TO SHIP ON 1/17/91

Hunter/ESE, Inc. 01-07-91
PROJECT NUMBER 6902021-0001

*** FIELD LOGSHEET ***
PROJECT NAME: CAMP LEJUENE

LAB COORD. KEVIN MCHUGH

ESI - SITE/STA HAZ? FRACTIONS(CIRCLE) DATE TIME PARAMETER LIST
V V V W W N N S S

US Pool (V) (V) V (W) W (N) N (S) S 1-16-91 1530 Full TCL

US Pool (V) (V) V (W) W (N) N (S) S 1-16-91 1535 Full TCL

V V V W W N N S S

V V V W W N N S S

V V V W W N N S S

V V V W W N N S S

V V V W W N N S S

V V V W W N N S S

V V V W W N N S S

V V V W W N N S S

V V V W W N N S S

V V V W W N N S S

V V V W W N N S S

NOTE -CHANGE OR ENTER SITE ID AS NECESSARY; UP TO 9 ALPHANUMERIC CHARACTERS MAY BE USED
-CIRCLE FRACTIONS COLLECTED. ENTER DATE, TIME, FIELD DATA (IF REQUIRED), HAZARD CODE AND NOTES
-HAZARD CODES: I-IGNITABLE C-CORROSIVE R-REACTIVE T-TOXIC WASTE H-OTHER ACUTE HAZARD; IDENTIFY
-PLEASE RETURN COMPLETED LOGSHEETS WITH SAMPLES TO Hunter/ESE, Inc.

RELINQUISHED BY: (NAME/ORGANIZATION/DATE/TIME) VIA: REC'D BY (NAME/ORGANIZATION/DATE/TIME)

1 Eric [unclear] ESE/1-16-91/1730 FEDEX FEDEX 9868702001
2 Jeff Whiting ESE 1/17/91

ER: MORE SAMPLES TO BE SHIPPED? IF YES, ANTICIPATED # 8 TO SHIP ON 1-17-91

Hunter/ESE, Inc. 01-07-91
PROJECT NUMBER 6902021-0001

*** FIELD LOGSHEET ***
PROJECT NAME: CAMP LEJUENE

FIELD GROUP: 90210001
LAB COORD. KEVIN MCHUGH

ESE #	SITE/STA	HAZ?	FRACTIONS(CIRCLE)	DATE	TIME	PARAMETER LIST
TR010	✓		V V V W W N N S S	1-17-91	0800	TCL VOA (3 containers)
HPGW9	✓		V V V W W N N S S	1-17-91	1450	Full TCL (7 containers)
HPGW21	✓		V V V W W N N S S	1-17-91	1330	Full TCL (7 containers)
			V V V W W N N S S			
			V V V W W N N S S			
			V V V W W N N S S			
			V V V W W N N S S			
			V V V W W N N S S			
			V V V W W N N S S			
			V V V W W N N S S			
			V V V W W N N S S			
			V V V W W N N S S			
			V V V W W N N S S			
			V V V W W N N S S			
			V V V W W N N S S			

NOTE - CHANGE OR ENTER SITE ID AS NECESSARY; UP TO 9 ALPHANUMERIC CHARACTERS MAY BE USED
- CIRCLE FRACTIONS COLLECTED. ENTER DATE, TIME, FIELD DATA (IF REQUIRED), HAZARD CODE AND NOTES
- HAZARD CODES: I=IGNITABLE C=CORROSIVE R=REACTIVE T=TOXIC WASTE H=OTHER ACUTE HAZARD; IDENTIFY
- PLEASE RETURN COMPLETED LOGSHEETS WITH SAMPLES TO Hunter/ESE, Inc.

RELINQUISHED BY: (NAME/ORGANIZATION/DATE/TIME) VIA: REC'D BY (NAME/ORGANIZATION/DATE/TIME)
1 K. Klime [ESE] 1-17-91 / 1700 Fed ex airbill # ~~9868701986~~
9868701986
-ESC 1/18/91
MORE SAMPLES TO BE SHIPPED? IF YES, ANTICIPATED # 10 TO SHIP ON 1/18/91

Hunter/ESE, Inc. 01-07-91
PROJECT NUMBER 6902021-0001

*** FIELD LOGSHEET ***
PROJECT NAME: CAMP LEJUENE

FIELD GROUP: 90210001
LAB COORD. KEVIN MCHUGH

ESE #	SITE/STA	HAZ?	FRACTIONS (CIRCLE)	DATE	TIME	PARAMETER LIST
HPGW31-3	✓	V	V W W N N S S	1-17-91	1010	Full TCL 7 containers
HPGW31-2	✓	V	V W W N N S S	1-17-91	1035	Full TCL 7 containers
48SW10	✓	V	V W W N N S S	1-17-91	0915	TCL Metals 1 container
48SW11	✓	V	V W W N N S S	1-17-91	0930	TCL Metals 1 container
48SW09	✓	V	V W W N N S S	1-17-91	0855	TCL Metals 1 container
		V	V W W N N S S			
		V	V W W N N S S			
		V	V W W N N S S			
		V	V W W N N S S			
		V	V W W N N S S			
		V	V W W N N S S			
		V	V W W N N S S			
		V	V W W N N S S			
		V	V W W N N S S			
		V	V W W N N S S			
		V	V W W N N S S			
		V	V W W N N S S			

NOTE -CHANGE OR ENTER SITE ID AS NECESSARY; UP TO 9 ALPHANUMERIC CHARACTERS MAY BE USED
-CIRCLE FRACTIONS COLLECTED. ENTER DATE, TIME, FIELD DATA (IF REQUIRED), HAZARD CODE AND NOTES
-HAZARD CODES: I=IGNITABLE C=CORROSIVE R=REACTIVE T=TOXIC WASTE H=OTHER ACUTE HAZARD; IDENTIFY
-PLEASE RETURN COMPLETED LOGSHEETS WITH SAMPLES TO Hunter/ESE, Inc.

RELINQUISHED BY: (NAME/ORGANIZATION/DATE/TIME) VIA: REC'D BY (NAME/ORGANIZATION/DATE/TIME)

1 Jim Case / ESE / 1-17-91 1800 hrs

Fed Ex # 9868701986

Jeff Kline / 1/19/91 ESE

MORE SAMPLES TO BE SHIPPED? Y IF YES, ANTICIPATED # 8 TO SHIP ON 1/18/91

Hunter/ESE, Inc. 01-07-91
PROJECT NUMBER 6902021-0001

*** FIELD LOGSHEET ***
PROJECT NAME: CAMP LEJUENE

FIELD GROUP: 90210001
LAB COORD. KEVIN MCHUCH

ESI #	SITE/STA	HAZ?	FRACTIONS (CIRCLE)					DATE	TIME	PARAMETER LIST				
DI 002			V	V	V	W	W	N	N	S	S	1-17-91	1317	Full TCL 7 containers
EBO13	✓		V	V	V	W	W	N	N	S	S	1-17-91	1350	Full TCL 7 containers
			V	V	V	W	W	N	N	S	S			
			V	V	V	W	W	N	N	S	S			
			V	V	V	W	W	N	N	S	S			
			V	V	V	W	W	N	N	S	S			
			V	V	V	W	W	N	N	S	S			
			V	V	V	W	W	N	N	S	S			
			V	V	V	W	W	N	N	S	S			
			V	V	V	W	W	N	N	S	S			
			V	V	V	W	W	N	N	S	S			
			V	V	V	W	W	N	N	S	S			
			V	V	V	W	W	N	N	S	S			
			V	V	V	W	W	N	N	S	S			
			V	V	V	W	W	N	N	S	S			
			V	V	V	W	W	N	N	S	S			
			V	V	V	W	W	N	N	S	S			

NOTE -CHANGE OR ENTER SITE ID AS NECESSARY; UP TO 9 ALPHANUMERIC CHARACTERS MAY BE USED
-CIRCLE FRACTIONS COLLECTED. ENTER DATE, TIME, FIELD DATA (IF REQUIRED), HAZARD CODE AND NOTES
-HAZARD CODES: I=IGNITABLE C=CORROSIVE R=REACTIVE T=TOXIC WASTE H=OTHER ACUTE HAZARD; IDENTIFY
-PLEASE RETURN COMPLETED LOGSHEETS WITH SAMPLES TO Hunter/ESE, Inc.

RELINQUISHED BY: (NAME/ORGANIZATION/DATE/TIME) VIA: REC'D BY (NAME/ORGANIZATION/DATE/TIME)
1 Jim Case ESE 1-17-91 1800 Fed Ex # 9868701986
2 Jeff Whelan 1/18/91 ESE

MORE SAMPLES TO BE SHIPPED? IF YES, ANTICIPATED # 8 TO SHIP ON 1/18/91

Hunter/ESE, Inc. 01-07-91
PROJECT NUMBER 6902021-0001

*** FIELD LOGSHEET ***
PROJECT NAME: CAMP LEJUENE

FIELD GROUP: 90210001
LAB COORD. KEVIN MCHUGH

ESE #	SITE/STA	HAZ?	FRACTIONS (CIRCLE)					DATE	TIME	PARAMETER LIST
6GW5	✓	(V)(V)	(V)(W)(W)	(N)(S)			1-18-91	1055	Full TCL 9 containers	
TB011	✓	(V)(V)	(V)(W)(W)	(N)(S)			1-18-91	0740	TCL VOA 3 containers	
HPGW25	✓	(V)(V)	(V)(W)(W)	(N)(S)			1-18-91	1445	Full TCL 7 containers	
HPGW22	✓	(V)(V)	(V)(W)(W)	(N)(S)			1-18-91	1340	Full TCL 7 containers	
6GW8	✓	(V)(V)	(V)(W)(W)	(N)(S)			1-18-91	1515	Full TCL 7 containers	
		V V V	W W N	N S S						
		V V V	W W N	N S S						
		V V V	W W N	N S S						
		V V V	W W N	N S S						
		V V V	W W N	N S S						
		V V V	W W N	N S S						
		V V V	W W N	N S S						
		V V V	W W N	N S S						
		V V V	W W N	N S S						
		V V V	W W N	N S S						

NOTE - CHANGE OR ENTER SITE ID AS NECESSARY; UP TO 9 ALPHANUMERIC CHARACTERS MAY BE USED
- CIRCLE FRACTIONS COLLECTED. ENTER DATE, TIME, FIELD DATA (IF REQUIRED), HAZARD CODE AND NOTES
- HAZARD CODES: I=IGNITABLE C=CORROSIVE R=REACTIVE T=TOXIC WASTE H=OTHER ACUTE HAZARD; IDENTIFY
- PLEASE RETURN COMPLETED LOGSHEETS WITH SAMPLES TO Hunter/ESE, Inc.

RELINQUISHED BY: (NAME/ORGANIZATION/DATE/TIME) VIA: REC'D BY (NAME/ORGANIZATION/DATE/TIME)
1 Jim Carr / ESE / 1-18-91 / 1800 986 870 1953
2 Jeff Wilson - ESE 1/19/91

FR: MORE SAMPLES TO BE SHIPPED? Y IF YES, ANTICIPATED # 8 TO SHIP ON 2/17/91

Hunter/ESE, Inc. 01-07-91
PROJECT NUMBER 6902021-0001

*** FIELD LOGSHEET ***
PROJECT NAME: CAMP LEJUENE

FIELD GROUP: 90210001
LAB COORD. KEVIN MCHUCH

ESE #	SITE/STA	HAZ?	FRACTIONS (CIRCLE)	DATE	TIME	PARAMETER LIST
HPGW23	✓		V V V W W N N S S	1-18-91	1055	Full TCL 7 containers
22GW1	✓		V V V W W N N S S	1-18-91	0925	Full TCL 7 containers
6GW7	✓		V V V W W N N S S	1-18-91	1300	Full TCL 9 containers
6GW4	✓		V V V W W N N S S	1-18-91	1010	Full TCL 7 containers
6GW6	✓		V V V W W N N S S	1-18-91	1208	Full TCL 9 containers
			V V V W W N N S S			
			V V V W W N N S S			
			V V V W W N N S S			
			V V V W W N N S S			
			V V V W W N N S S			
			V V V W W N N S S			
			V V V W W N N S S			
			V V V W W N N S S			
			V V V W W N N S S			
			V V V W W N N S S			

NOTE -CHANGE OR ENTER SITE ID AS NECESSARY; UP TO 9 ALPHANUMERIC CHARACTERS MAY BE USED
-CIRCLE FRACTIONS COLLECTED. ENTER DATE, TIME, FIELD DATA (IF REQUIRED), HAZARD CODE AND NOTES
-HAZARD CODES: I=IGNITABLE C=CORROSIVE R=REACTIVE T=TOXIC WASTE H=OTHER ACUTE HAZARD; IDENTIFY
-PLEASE RETURN COMPLETED LOGSHEETS WITH SAMPLES TO Hunter/ESE, Inc.

RELINQUISHED BY: (NAME/ORGANIZATION/DATE/TIME) VIA: REC'D BY (NAME/ORGANIZATION/DATE/TIME)
1 Jim Carr / ESE / 1-18-91 1300 Fed Ex # 9868701953
2
Jeff Wilson - ESE 1/19/91

ARE THERE MORE SAMPLES TO BE SHIPPED? Y IF YES, ANTICIPATED # 5 TO SHIP ON 1/19/91

Hunter/ESE, Inc. 01-07-91
PROJECT NUMBER 6902021-0001

*** FIELD LOGSHEET ***
PROJECT NAME: CAMP LEJUENE

FIELD GROUP: 90210001
LAB COORD. KEVIN MCHUGH

ESE #	SITE/STA	HAZ?	FRACTIONS (CIRCLE)					DATE	TIME	PARAMETER LIST				
GW Dup 8			V	V	V	W	W	N	N	S	S	1-19-91	0920	Full TCL MS/MSD
GW Dup 8			V	V	V	W	W	N	N	S	S	1-19-91	0920	Full TCL MS/MSD
			V	V	V	W	W	N	N	S	S			
			V	V	V	W	W	N	N	S	S			
			V	V	V	W	W	N	N	S	S			
			V	V	V	W	W	N	N	S	S			
			V	V	V	W	W	N	N	S	S			
			V	V	V	W	W	N	N	S	S			
			V	V	V	W	W	N	N	S	S			
			V	V	V	W	W	N	N	S	S			
			V	V	V	W	W	N	N	S	S			
			V	V	V	W	W	N	N	S	S			
			V	V	V	W	W	N	N	S	S			
			V	V	V	W	W	N	N	S	S			
			V	V	V	W	W	N	N	S	S			
			V	V	V	W	W	N	N	S	S			

} 14 containers

NOTE -CHANGE OR ENTER SITE ID AS NECESSARY; UP TO 9 ALPHANUMERIC CHARACTERS MAY BE USED
-CIRCLE FRACTIONS COLLECTED. ENTER DATE, TIME, FIELD DATA (IF REQUIRED), HAZARD CODE AND NOTES
-HAZARD CODES: I=IGNITABLE C=CORROSIVE R=REACTIVE T=TOXIC WASTE H=OTHER ACUTE HAZARD: IDENTIFY
-PLEASE RETURN COMPLETED LOGSHEETS WITH SAMPLES TO Hunter/ESE, Inc.

RELINQUISHED BY: (NAME/ORGANIZATION/DATE/TIME) VIA: REC'D BY (NAME/ORGANIZATION/DATE/TIME)
1 Jim Case / ESE / 1-19-91 1500 Fed Ex # 9868701942
2 Jeff Lewis 1/21/91

MORE SAMPLES TO BE SHIPPED? Y IF YES, ANTICIPATED # 8 TO SHIP ON 1/21/91

Hunter/ESE, Inc. 01-07-91
PROJECT NUMBER 6902021-0001

*** FIELD LOGSHEET ***
PROJECT NAME: CAMP LEJUENE

FIELD GROUP: 90210001
LAB COORD. KEVIN MCHUGH

ESE #	SITE/STA	HAZ?	FRACTIONS (CIRCLE)	DATE	TIME	PARAMETER LIST
TB-012			V V V W W N N S S	1-19-91	0745	Full TCL VOA 3 containers
6 GW 2			V V W W N N S S	1-19-91	0840	Full TCL 6 containers
HPGW26			V V V W W N N S S	1-19-91	0920	Full TCL MS/MSD 7 containers
			V V V W W N N S S			
			V V V W W N N S S			
			V V V W W N N S S			
			V V V W W N N S S			
			V V V W W N N S S			
			V V V W W N N S S			
			V V V W W N N S S			
			V V V W W N N S S			
			V V V W W N N S S			
			V V V W W N N S S			
			V V V W W N N S S			
			V V V W W N N S S			
			V V V W W N N S S			

NOTE -CHANGE OR ENTER SITE ID AS NECESSARY; UP TO 9 ALPHANUMERIC CHARACTERS MAY BE USED
-CIRCLE FRACTIONS COLLECTED. ENTER DATE, TIME, FIELD DATA (IF REQUIRED), HAZARD CODE AND NOTES
-HAZARD CODES: I=IGNITABLE C=CORROSIVE R=REACTIVE T=TOXIC WASTE H=OTHER ACUTE HAZARD; IDENTIFY
-PLEASE RETURN COMPLETED LOGSHEETS WITH SAMPLES TO Hunter/ESE, Inc.

RELINQUISHED BY: (NAME/ORGANIZATION/DATE/TIME) VIA: REC'D BY (NAME/ORGANIZATION/DATE/TIME)

1 Jim Case / ESE / 1-19-91 / 1500

Fed Ex # 9868701942

J. Phillips 1/21/91

ER: MORE SAMPLES TO BE SHIPPED? Y IF YES, ANTICIPATED # 8 TO SHIP ON 1/21/91

Hunter/ESE, Inc. 01-07-91
PROJECT NUMBER 6902021-0001

*** FIELD LOGSHEET ***
PROJECT NAME: CAMP LEJUENE

FIELD GROUP: 90210001
LAB COORD. KEVIN MCHUGH

ESE # SITE/STA HAZ? FRACTIONS(CIRCLE) DATE TIME PARAMETER LIST
V V V W W N N S S

WS603 ✓ (V) (V) (V) (W) (W) (N) N (S) S 1/22/91 1135 FULL TCL (7 CONTAINERS)

WS642 ✓ (V) (V) (V) (W) (W) (N) N (S) S 1/22/91 1154 FULL TCL (7 CONTAINERS)

V V V W W N N S S

V V V W W N N S S

V V V W W N N S S

V V V W W N N S S

V V V W W N N S S

V V V W W N N S S

V V V W W N N S S

V V V W W N N S S

V V V W W N N S S

V V V W W N N S S

V V V W W N N S S

NOTE -CHANGE OR ENTER SITE ID AS NECESSARY; UP TO 9 ALPHANUMERIC CHARACTERS MAY BE USED
-CIRCLE FRACTIONS COLLECTED. ENTER DATE, TIME, FIELD DATA (IF REQUIRED), HAZARD CODE AND NOTES
-HAZARD CODES: I=IGNITABLE C=CORROSIVE R=REACTIVE T=TOXIC WASTE H=OTHER ACUTE HAZARD: IDENTIFY
-PLEASE RETURN COMPLETED LOGSHEETS WITH SAMPLES TO Hunter/ESE, Inc.

RELINQUISHED BY: (NAME/ORGANIZATION/DATE/TIME)

VIA:

REC'D BY (NAME/ORGANIZATION/DATE/TIME)

1 EL Kyzel /ESE/ 1-22-91/

Fed. Ex. Airbill # 9868701931

Jeff Wilson -ESE 1/23/91

MORE SAMPLES TO BE SHIPPED? ___ IF YES, ANTICIPATED # ___ TO SHIP ON ___ / ___ / ___

Hunter/ESE, Inc. 01-07-91
PROJECT NUMBER 6902021-0001

*** FIELD LOGSHEET ***
PROJECT NAME: CAMP LEJUENE

FIELD GROUP: 90210001
LAB COORD. KEVIN MCHUGH

7

ESE #	SITE/STA HAZ?	FRACTIONS(CIRCLE)	DATE	TIME	PARAMETER LIST
	V V V W W N N S S				
WS652	V V V W W N N S S		1/22/91	1322	FULL TCL (7 containers)
GWDUP9	V V V W W N N S S		1/22/91	1355	FULL TCL (14 containers) ms/msd
WS653	V V V W W N N S S		1/22/91	1517	FULL TCL (7 containers)
	V V V W W N N S S				
	V V V W W N N S S				
	V V V W W N N S S				
	V V V W W N N S S				
	V V V W W N N S S				
	V V V W W N N S S				
	V V V W W N N S S				
	V V V W W N N S S				
	V V V W W N N S S				
	V V V W W N N S S				
	V V V W W N N S S				
	V V V W W N N S S				

NOTE -CHANGE OR ENTER SITE ID AS NECESSARY; UP TO 9 ALPHANUMERIC CHARACTERS MAY BE USED
-CIRCLE FRACTIONS COLLECTED. ENTER DATE, TIME, FIELD DATA (IF REQUIRED), HAZARD CODE AND NOTES
-HAZARD CODES: I-IGNITABLE C-CORROSIVE R-REACTIVE T-TOXIC WASTE H-OTHER ACUTE HAZARD; IDENTIFY
-PLEASE RETURN COMPLETED LOGSHEETS WITH SAMPLES TO Hunter/ESE, Inc.

RELINQUISHED BY: (NAME/ORGANIZATION/DATE/TIME) VIA: REC'D BY (NAME/ORGANIZATION/DATE/TIME)
1 ESE/Hunter/ESE/1/22/91/1615 FED Ex Arbit # 9868701931
2 Jeff Whiting - ESE 1/23/91

MORE SAMPLES TO BE SHIPPED? ___ IF YES, ANTICIPATED # ___ TO SHIP ON ___/___/___

Hunter/ESE, Inc. 01-07-91
PROJECT NUMBER 6902021-0001

*** FIELD LOGSHEET ***
PROJECT NAME: CAMP LEJUENE

FIELD GROUP: 90210001
LAB COORD. KEVIN MCHUGH

ESE #	SITE/STA	HAZ?	FRACTIONS(CIRCLE)	DATE	TIME	PARAMETER LIST
	V	V	V W W N N S S			
WS637	✓	⓪	⓪	1/22/91	1015	FULL TCL (7 CONTAINERS)
WS602	✓	⓪	⓪	1/22/91	1047	FULL TCL (7 CONTAINERS)
WS660		⓪	⓪	1/22/91	1120	FULL TCL (7 CONTAINERS)
TB013		⓪	⓪	1/22/91	0910	TCL VOA (3 CONTAINERS)
	V	V	V W W N N S S			
	V	V	V W W N N S S			
	V	V	V W W N N S S			
	V	V	V W W N N S S			
	V	V	V W W N N S S			
	V	V	V W W N N S S			
	V	V	V W W N N S S			
	V	V	V W W N N S S			
	V	V	V W W N N S S			

NOTE -CHANGE OR ENTER SITE ID AS NECESSARY; UP TO 9 ALPHANUMERIC CHARACTERS MAY BE USED
-CIRCLE FRACTIONS COLLECTED. ENTER DATE, TIME, FIELD DATA (IF REQUIRED), HAZARD CODE AND NOTES
-HAZARD CODES: I=IGNITABLE C=CORROSIVE R=REACTIVE T=TOXIC WASTE H=OTHER ACUTE HAZARD: IDENTIFY
-PLEASE RETURN COMPLETED LOGSHEETS WITH SAMPLES TO Hunter/ESE, Inc.

RELINQUISHED BY: (NAME/ORGANIZATION/DATE/TIME) VIA: REC'D BY (NAME/ORGANIZATION/DATE/TIME)

1 E. Q. Rybolt / ESE / 1-22-91 /

FRA Ex. Arb. # 9868701931

Jeff Whiting - ESE 1/22/91

MORE SAMPLES TO BE SHIPPED? ___ IF YES, ANTICIPATED # ___ TO SHIP ON ___/___/___

Hunter/ESE, Inc. 01-07-91
PROJECT NUMBER 6902021-0001

*** FIELD LOGSHEET ***
PROJECT NAME: CAMP LEJUENE

FIELD GROUP: 90210001
LAB COORD. KEVIN MCHUGH

ESE #	SITE/STA	HAZ?	FRACTIONS(CIRCLE)					DATE	TIME	PARAMETER LIST
	V	V	V	W	W	N	N	S	S	
W5634 ✓	⓪	⓪	⓪	⓪	⓪	N	N	⓪	S	1/22/91 1355 Full TCL (7 CONTAINERS)
W5651	⓪	⓪	⓪	⓪	⓪	N	N	⓪	S	1/22/91 1434 FULL TCL (7 CONTAINERS)
	V	V	V	W	W	N	N	S	S	
	V	V	V	W	W	N	N	S	S	
	V	V	V	W	W	N	N	S	S	
	V	V	V	W	W	N	N	S	S	
	V	V	V	W	W	N	N	S	S	
	V	V	V	W	W	N	N	S	S	
	V	V	V	W	W	N	N	S	S	
	V	V	V	W	W	N	N	S	S	
	V	V	V	W	W	N	N	S	S	
	V	V	V	W	W	N	N	S	S	
	V	V	V	W	W	N	N	S	S	
	V	V	V	W	W	N	N	S	S	
	V	V	V	W	W	N	N	S	S	

NOTE -CHANGE OR ENTER SITE ID AS NECESSARY; UP TO 9 ALPHANUMERIC CHARACTERS MAY BE USED
-CIRCLE FRACTIONS COLLECTED. ENTER DATE, TIME, FIELD DATA (IF REQUIRED), HAZARD CODE AND NOTES
-HAZARD CODES: I=IGNITABLE C=CORROSIVE R=REACTIVE T=TOXIC WASTE H=OTHER ACUTE HAZARD; IDENTIFY
-PLEASE RETURN COMPLETED LOGSHEETS WITH SAMPLES TO Hunter/ESE, Inc.

RELINQUISHED BY: (NAME/ORGANIZATION/DATE/TIME) VIA: REC'D BY (NAME/ORGANIZATION/DATE/TIME)
1 E.L. Rydz /ESE/ 1-22-91/ Fed Ex. Airbill # 9868701931
2 [Signature] -ESE 1/23/91

MORE SAMPLES TO BE SHIPPED? ___ IF YES, ANTICIPATED # ___ TO SHIP ON ___/___/___

Hunter/ESE, Inc. 01-07-91
PROJECT NUMBER 6902021-0001

*** FIELD LOGSHEET ***
PROJECT NAME: CAMP LEJUENE

FIELD GROUP: 90210001
LAB COORD. KEVIN MCHUGH

ESE #	SITE/STA	HAZ?	FRACTIONS(CIRCLE)	DATE	TIME	PARAMETER LIST
22GW2 ✓	V V V	W W	N N S S	1-24-91	10:15	Temp 46.1°F PH = 5.60 Cond. = 829 (7 containers)
21GW1 ✓	V V V	W W	N N S S	1-24-91	11:35	Temp 48.4°F PH = 3.25 Cond = 679 (7 containers)
	V V V	W W	N N S S			
	V V V	W W	N N S S			
	V V V	W W	N N S S			
	V V V	W W	N N S S			
	V V V	W W	N N S S			
	V V V	W W	N N S S			
	V V V	W W	N N S S			
	V V V	W W	N N S S			
	V V V	W W	N N S S			
	V V V	W W	N N S S			
	V V V	W W	N N S S			
	V V V	W W	N N S S			
	V V V	W W	N N S S			

NOTE -CHANGE OR ENTER SITE ID AS NECESSARY; UP TO 9 ALPHANUMERIC CHARACTERS MAY BE USED
-CIRCLE FRACTIONS COLLECTED. ENTER DATE, TIME, FIELD DATA (IF REQUIRED), HAZARD CODE AND NOTES
-HAZARD CODES: I=IGNITABLE C=CORROSIVE R=REACTIVE T=TOXIC WASTE H=OTHER ACUTE HAZARD; IDENTIFY
-PLEASE RETURN COMPLETED LOGSHEETS WITH SAMPLES TO Hunter/ESE, Inc.

RELINQUISHED BY: (NAME/ORGANIZATION/DATE/TIME) VIA: REC'D BY (NAME/ORGANIZATION/DATE/TIME)

1 Jerome Fine / ESE / 1-24-91 / 1700

2

3

Joe Fine # 98687012816
ESE 1/25/91

SAMPLER: MORE SAMPLES TO BE SHIPPED? ___ IF YES, ANTICIPATED # ___ TO SHIP ON ___/___/___