

03.13-08/22/96-01710

FINAL

**REMEDIAL INVESTIGATION REPORT
OPERABLE UNIT NO. 6
(SITE 36)**

**MARINE CORPS BASE
CAMP LEJEUNE, NORTH CAROLINA**

**CONTRACT TASK ORDER 0303
TEXT AND FIGURES
VOLUME I
AUGUST 22, 1996**

Prepared For:

**DEPARTMENT OF THE NAVY
ATLANTIC DIVISION
NAVAL FACILITIES
ENGINEERING COMMAND
*Norfolk, Virginia***

Under:

**LANTDIV CLEAN Program
Contract N62470-89-D-4814**

Prepared by:

**BAKER ENVIRONMENTAL, INC.
*Coraopolis, Pennsylvania***

TABLE OF CONTENTS

	<u>Page</u>
EXECUTIVE SUMMARY	ES-1
1.0 INTRODUCTION	1-1
1.1 Report Organization	1-1
1.2 Background and Setting of MCB, Camp Lejeune	1-2
1.2.1 Location and Setting	1-2
1.2.2 History	1-2
1.2.3 Operable Unit Description	1-2
1.2.4 Topography	1-3
1.2.5 Surface Water Hydrology	1-3
1.2.6 Geology	1-3
1.2.7 Hydrogeology	1-4
1.2.8 Ecology	1-5
1.2.9 Land Use Demographics	1-9
1.2.10 Meteorology	1-10
1.3 Background and Setting of Site 36	1-10
1.3.1 Site Location and Setting	1-11
1.3.2 Site History	1-11
1.4 Previous Investigations	1-11
1.4.1 Initial Assessment Study	1-11
1.4.2 Confirmation Study	1-11
1.4.3 Additional Investigations	1-14
1.4.4 Aerial Photographic Investigation	1-15
1.5 Remedial Investigation Objectives	1-16
1.6 References	1-17
2.0 SITE CHARACTERISTICS	2-1
2.1 Topography and Surface Features	2-1
2.2 Surface Water Hydrology	2-1
2.3 Soil	2-1
2.4 Geology	2-2
2.5 Hydrogeology	2-4
2.5.1 Groundwater Elevation Data	2-4
2.5.2 Groundwater Flow Contour Maps	2-5
2.5.3 Hydraulic Properties	2-5
2.5.4 Groundwater Flow Velocities	2-6
2.5.5 General Groundwater Flow Patterns	2-7
2.6 Identification of Water Supply Wells	2-7
2.7 Ecology	2-8
2.8 References	2-10

TABLE OF CONTENTS
(Continued)

	<u>Page</u>
3.0 STUDY AREA INVESTIGATIONS	3-1
3.1 Site Survey	3-1
3.2 Soil Investigation	3-1
3.2.1 Soil Sampling Procedures	3-2
3.2.2 Sampling Locations	3-3
3.2.3 Exploratory Test Pits	3-4
3.2.4 Analytical Program	3-4
3.2.5 Quality Assurance and Quality Control	3-5
3.2.6 Air Monitoring and Field Screening	3-6
3.3 Groundwater Investigation	3-6
3.3.1 Monitoring Well Installation	3-6
3.3.2 Monitoring Well Development	3-8
3.3.3 Water Level Measurements	3-8
3.3.4 Aquifer Testing	3-8
3.3.5 Sampling Locations	3-9
3.3.6 Sampling Procedures	3-9
3.3.7 Analytical Program	3-10
3.3.8 Quality Assurance and Quality Control	3-10
3.3.9 Field Screening and Air Monitoring	3-10
3.4 Surface Water and Sediment Investigations	3-10
3.4.1 Sampling Locations	3-11
3.4.2 Sampling Procedures	3-11
3.4.3 Analytical Program	3-11
3.4.4 Quality Assurance and Quality Control	3-12
3.5 Aquatic Investigation	3-12
3.5.1 Media Types	3-12
3.5.2 Sampling Locations	3-12
3.5.3 Sampling Procedures	3-12
3.5.4 Analytical Program	3-13
3.6 Habitat Evaluation	3-13
3.7 Decontamination Procedures	3-14
3.8 Investigation Derived Waste (IDW) Handling	3-14
3.9 References	3-15
4.0 NATURE AND EXTENT OF CONTAMINATION	4-1
4.1 Data Quality	4-1
4.1.1 Data Management and Tracking	4-1
4.2 Non-Site Related Analytical Results	4-2
4.2.1 Laboratory Contaminants	4-2
4.2.2 Naturally-Occurring Inorganic Analytes	4-3
4.3 Analytical Results	4-5
4.3.1 Soil Investigation	4-5

TABLE OF CONTENTS
(Continued)

		<u>Page</u>
	4.3.2 Groundwater Investigation	4-8
	4.3.3 Surface Water Investigation	4-11
	4.3.4 Sediment Investigation	4-12
4.4	Extent of Contamination	4-14
	4.4.1 Extent of Soil Contamination	4-14
	4.4.2 Extent of Groundwater Contamination	4-15
	4.4.3 Extent of Surface Water Contamination	4-17
	4.4.4 Extent of Sediment Contamination	4-18
4.5	References	4-20
5.0	CONTAMINANT FATE AND TRANSPORT	5-1
5.1	Chemical and Physical Properties Impacting Fate and Transport	5-1
5.2	Contaminant Transport Pathways	5-2
	5.2.1 Windblown Dust/Volatilization	5-3
	5.2.2 Leaching of Sediment Contaminants to Surface Water	5-3
	5.2.3 Leaching of Soil Contaminants to Groundwater	5-3
	5.2.4 Migration of Groundwater Contaminants	5-4
5.3	Fate and Transport Summary	5-6
	5.3.1 Volatile Organic Compounds	5-7
	5.3.2 Semivolatile Organic Compounds	5-8
	5.3.3 Pesticides/Polychlorinated Biphenyls	5-8
	5.3.4 Metals	5-8
5.4	References	5-10
6.0	BASELINE HUMAN HEALTH RISK ASSESSMENT	6-1
6.1	Introduction	6-1
6.2	Hazard Identification	6-2
	6.2.1 Data Evaluation and Reduction	6-2
	6.2.2 Identification of Data Suitable for Use in a Quantitative Risk Assessment	6-3
	6.2.3 Criteria Used in Selection of COPCs	6-3
	6.2.4 Contaminants of Potential Concern	6-8
6.3	Exposure Assessment	6-13
	6.3.1 Potential Human Receptors and Adjacent Populations	6-14
	6.3.2 Migration Exposure Pathways	6-15
	6.3.3 Quantification of Exposure	6-18
	6.3.4 Calculation of Chronic Daily Intakes	6-19
6.4	Toxicity Assessment	6-31
	6.4.1 Carcinogenic Slope Factor	6-31
	6.4.2 Reference Dose	6-32
	6.4.3 Lead	6-34
	6.4.4 Dermal Adjustment of Toxicity Factors	6-34

TABLE OF CONTENTS
(Continued)

	<u>Page</u>
6.5	Risk Characterization 6-34
6.5.1	Human Health Risks 6-35
6.6	Lead UBK Model Results 6-37
6.7	Sources of Uncertainty 6-38
6.7.1	Analytical Data 6-38
6.7.2	Exposure Assessment 6-39
6.7.3	Sampling Strategy 6-40
6.7.4	Toxicity Assessment 6-40
6.8	Conclusions of the BRA for Site 36 6-41
6.8.1	Current Scenario 6-41
6.8.2	Future Scenario 6-41
6.8.3	Lead 6-42
6.9	References 6-43
7.0	ECOLOGICAL RISK ASSESSMENT 7-1
7.1	Objectives, Scope, and Organization of the Ecological Risk Assessment . . . 7-1
7.2	Problem Formulation 7-2
7.3	Contaminants of Potential Concern 7-2
7.3.1	Criteria for Selecting Contaminants of Potential Concern 7-2
7.3.2	Selection of Contaminants of Potential Concern 7-7
7.3.3	Physical/Chemical Characteristics of COPCs 7-11
7.4	Ecosystems Potentially at Risk 7-12
7.5	Ecological Endpoints 7-13
7.5.1	Aquatic Endpoints 7-13
7.5.2	Terrestrial Endpoints 7-16
7.6	Conceptional Model 7-16
7.6.1	Soil Exposure Pathway 7-17
7.6.2	Groundwater Exposure Pathway 7-17
7.6.3	Surface Water and Sediment Exposure Pathway 7-17
7.6.4	Air Exposure Pathway 7-18
7.7	Exposure Assessment 7-18
7.7.1	Surface Water, Sediment, and Biological Sampling 7-19
7.8	Ecological Effects Characterization 7-21
7.8.1	Surface Water 7-21
7.8.2	Sediment 7-22
7.8.3	Fish Tissue 7-23
7.8.4	Surface Soil 7-25
7.8.5	Terrestrial Chronic Daily Intake Model 7-25
7.9	Risk Characterization 7-28
7.9.1	Surface Water 7-28
7.9.2	Sediment 7-29
7.9.3	Terrestrial Chronic Daily Intake Model 7-30

TABLE OF CONTENTS
(Continued)

	<u>Page</u>
7.10 Ecological Significance	7-31
7.10.1 Aquatic Receptors	7-31
7.10.2 Terrestrial Receptors	7-32
7.10.3 Threatened and Endangered Species	7-33
7.10.4 Wetlands	7-33
7.11 Uncertainty Analysis	7-33
7.12 Conclusions	7-35
7.12.1 Aquatic Ecosystem	7-35
7.12.2 Terrestrial Ecosystem	7-36
7.13 References	7-37
8.0 CONCLUSIONS AND RECOMMENDATIONS	8-1
8.1 Conclusions	8-1
8.2 Recommendations	8-2

APPENDICES

A	Test Boring Records
B	Test Boring and Well Construction Records
C	Exploratory Test Pit Records
D	Chain-of-Custody Forms
E	Field Well Development Records
F	Investigation Derived Waste Summary and Recommendations
G	Sampling Summaries
H	Data and Frequency Summaries
I	Statistical Summaries
J	Field Duplicate Summaries
K	QA/QC Sampling Summaries
L	Grain Size Analytical Results
M	Wet Chemistry Analytical Results
N	Aquifer Test Results
O	Aquifer Property Calculations
P	Base Background Analytical Results and Evaluation Report
Q	Shower Model
R	Lead UBK Model
S	Site Conceptual Model
T	CDI Calculations
U	Field Data Sheets
V	White Oak River Basin Reference Stations
W	Positive Detection Summary for Upstream Surface Water and Sediment Samples
X	Screening Value and Quotient Index Calculations
Y	Fish and Crab Sample Collection Logs
Z	Benthic Macroinvertebrate Raw Data Tables and Laboratory Bench Sheets
AA	Terrestrial Reference Values and Cdi Calculations

LIST OF TABLES

- ES-1 Summary of Site Contamination
 - 1-1 Geologic and Hydrogeologic Units of North Carolina's Coastal Plain
 - 1-2 Summary of Hydraulic Properties Unrelated Site Investigations
 - 1-3 Hydraulic Property Estimates of the Castle Hayne Aquifer
 - 1-4 Protected Species Within MCB, Camp Lejeune
 - 1-5 Land Utilization Within Developed Areas of MCB, Camp Lejeune
 - 1-6 Climatic Data Summary Marine Corps Air Station, New River
 - 1-7 Summary of Monitoring Well Construction Details Confirmation Study
 - 1-8 Detected Target Contaminants in Groundwater Confirmation Study
 - 1-9 Detected Target Contaminants in Sediment Confirmation Study
 - 1-10 Detected Organic Compounds in Soil RI Scoping Investigation
 - 1-11 Detected Inorganics in Soil RI Scoping Investigation
 - 1-12 Remedial Investigation Objectives

- 2-1 Summary of Soil Physical Properties at Site 36
- 2-2 Summary of Groundwater and Surface Water Elevations
- 2-3 Hydraulic Properties Summary
- 2-4 Summary of Potable Water Supply Wells Within a One-mile Radius of Site 36

- 3-1 Soil Sampling Summary Test Borings
- 3-2 Soil Sampling Summary Monitoring Well Test Borings
- 3-3 Soil Sampling Summary Exploratory Test Pits
- 3-4 Quality Assurance/Quality Control Sampling Program Soil Investigation
- 3-5 Summary of Well Construction Details
- 3-6 Summary of Water Level Measurements
- 3-7 Summary of Groundwater Field Parameters Round One
- 3-8 Summary of Groundwater Field Parameters Round Two
- 3-9 Groundwater Sampling Summary Round One
- 3-10 Groundwater Sampling Summary Round Two
- 3-11 Quality Assurance/Quality Control Sampling Program Groundwater Investigation
- 3-12 Summary of Surface Water Field Parameters
- 3-13 Surface Water and Sediment Sampling Summary
- 3-14 Quality Assurance/Quality Control Sampling Program Surface Water and Sediment Investigation

- 4-1 Summary of Rejected Data
- 4-2 Summary of Site Contamination
- 4-3 Surface Soil - Positive Detection Summary, TCL Organics
- 4-4 Surface Soil - Positive Detection Summary, TAL Metals
- 4-5 Subsurface Soil - Positive Detection Summary, TCL Organics
- 4-6 Subsurface Soil - Positive Detection Summary, TAL Metals
- 4-7 Groundwater - Positive Detection Summary, Round 1, TCL Organics
- 4-8 Groundwater - Positive Detection Summary, Round 1, TAL Metals
- 4-9 Groundwater - Positive Detection Summary, Round 1, TAL Dissolved Metals
- 4-10 Groundwater - Positive Detection Summary, Round 2, TCL Organics
- 4-11 Surface Water - Positive Detection Summary, TCL Organics

LIST OF TABLES (Continued)

- 4-12 Surface Water - Positive Detection Summary, TAL Metals
- 4-13 Surface Water - Positive Detection Summary, TAL Dissolved Metals
- 4-14 Sediment - Positive Detection Summary, TCL Organics
- 4-15 Sediment - Positive Detection Summary, TAL Metals

- 5-1 Organic Physical and Chemical Properties
- 5-2 Relative Mobilities of Metals as a Function of Environmental Conditions (Eh, pH)

- 6-1 Contaminants of Potential Concern - Organics in Surface Soil
- 6-2 Contaminants of Potential Concern - Inorganics in Surface Soil
- 6-3 Contaminants of Potential Concern - Organics in Subsurface Soil
- 6-4 Contaminants of Potential Concern - Inorganics in Subsurface Soil
- 6-5 Contaminants of Potential Concern in Groundwater
- 6-6 Contaminants of Potential Concern in Surface Water
- 6-7 Contaminants of Potential Concern in Sediment
- 6-8 Contaminants of Potential Concern in Fish and Crab Tissue
- 6-9 Summary of Exposure Dose Input Parameters
- 6-10 Summary of Exposure Pathways
- 6-11 Summary of Health-Based Criteria
- 6-12 Summary of Dermal-Adjusted Health-Based Criteria
- 6-13 Summary of Risks for the Military Receptor
- 6-14 Summary of Risks for the Child Trespasser
- 6-15 Summary of Risks for the Future Child Resident
- 6-16 Summary of Risks for the Adult Trespasser
- 6-17 Summary of Risks for the Future Adult Resident
- 6-18 Summary of Risks for the Fisherman Receptor
- 6-19 Summary of Risks for the Construction Worker
- 6-20 Summary of Uncertainties in the Results of the Human Health Risk Assessment
- 6-21 Summary of Contaminants Contributing to Site Risks

- 7-1 Frequency and Range of Contaminant Detections Compared to Freshwater Surface Water Screening Values
- 7-2 Frequency and Range of Dissolved Contaminant Detections Compared to Freshwater Surface Water Screening Values
- 7-3 Frequency and Range of Contaminant Detections Compared to Saltwater Surface Water Screening Values
- 7-4 Frequency and Range of Dissolved Contaminant Detections Compared to Saltwater Surface Water Screening Values
- 7-5 Frequency and Range of Contaminant Detections Compared to Freshwater Sediment Screening Values
- 7-6 Frequency and Range of Contaminant Detections Compared to Saltwater Sediment Screening Values
- 7-7 Contaminants of Potential Concern in Each Media
- 7-8 Physical/Chemical Characteristics of the COPCs
- 7-9 Sampling Station Characterization Summary
- 7-10 Field Chemistry Data
- 7-11 Total Number of Aquatic Species Collected Per Station

LIST OF TABLES (Continued)

- 7-12 Fish Distribution and Characterization
- 7-13 Number and Percentage of Benthic Macroinvertebrate Species per Station
- 7-14 USEPA Tolerance Values for Organic Waste and Metals, and North Carolina Biotic Index for Benthic Macroinvertebrates
- 7-15 Summary Statistics of Benthic Macroinvertebrate Species
- 7-16 Results of the Jaccard Coefficient of Community Similarity and Sørensen Index of Community Similarity Between the Benthic Macroinvertebrate Stations
- 7-17 List of Biota Species that were Chemically Analyzed
- 7-18 Comparison of Contaminant Levels in Tissue Samples Collected in Brinson Creek to Contaminant Levels in Tissue Samples Collected in Other Studies
- 7-19 Comparison of Whole Body Fish Tissue Concentrations to Proposed Piscivorous Wildlife Criteria
- 7-20 Frequency and Range of Contaminant Detections Compared to Soil Flora and Fauna Screening Values
- 7-21 Exposure Parameters for Chronic Daily Intake Model
- 7-22 Freshwater Surface Water Quotient Index
- 7-23 Saltwater Surface Water Quotient Index
- 7-24 Freshwater Sediment Quotient Index
- 7-25 Saltwater Sediment Quotient Index
- 7-26 Terrestrial Intake Model Quotient Index

LIST OF FIGURES

- 1-1 Operable Unit No. 6 - Sites 36, 43, 44, 54, and 86
- 1-2 Operable Units and Site Locations
- 1-3 Locations of Hydrogeologic Cross-Sections
- 1-4 Hydrogeologic Cross-Sections
- 1-5 Site Map, Site 36 - Camp Geiger Area Dump
- 1-6 Confirmation Study Sampling Locations
- 1-7 Drum and/or Container Areas
- 1-8 Aerial Photograph - October 1949
- 1-9 Aerial Photograph - February 1956
- 1-10 Aerial Photograph - December 1960
- 1-11 Aerial Photograph - February 1964
- 1-12 Aerial Photograph - October 1970

- 2-1 Cross-Section and Approximate Surface Elevation Contour Location Map
- 2-2 Geologic Cross-sections A-A' through G-G'
- 2-3A Groundwater Elevation Trends
- 2-3B Groundwater Elevation Trends
- 2-3C Groundwater Elevation Trends
- 2-3D Groundwater Elevation Trends
- 2-3E Groundwater Elevation Trends
- 2-4 Surficial/Aquifer Groundwater Contour Map
- 2-5 Castle Hayne Aquifer Groundwater Contour Map
- 2-6 Potable Water Supply Wells within a One-Mile Radius
- 2-7 Biohabitat Map

- 3-1 Soil Sampling Locations
- 3-2 Monitoring Well Locations
- 3-3 Typical Shallow Type II Groundwater Monitoring Well Construction Diagram
- 3-4 Typical Intermediate Type II Groundwater Monitoring Well Construction Diagram
- 3-5 Typical Deep Type III Groundwater Monitoring Well Construction Diagram
- 3-6 Surface Water, Sediment, and Aquatic Sampling Locations

- 4-1 Organic Compounds in Surface Soil
- 4-2 Organic Compounds in Subsurface Soil
- 4-3 Organic Compounds in Groundwater
- 4-4 TAL Metals in Groundwater Above Screening Standards
- 4-5 Organic Compounds in Surface Water
- 4-6 TAL Metals in Surface Water Above Screening Values
- 4-7 Organic Compounds in Sediment
- 4-8 TAL Metals in Sediment Above Screening Values

- 6-1 Flowchart of Potential Exposure Pathways and Receptors
- 6-2 Cumulative Probability Percent of Blood Lead Levels - Site 36 Surface Soil Exposure
- 6-3 Probability Distribution of Blood Lead Levels - Site 36 Surface Soil Exposure
- 6-4 Cumulative Probability Percent of Blood Lead Levels - Site 36 Subsurface Soil Exposure

LIST OF FIGURES
(Continued)

- 6-5 Probability Distribution of Blood Lead Levels - Site 36 Subsurface Soil Exposure
- 6-6 Cumulative Probability Percent of Blood Lead Levels -Site 36 Crab Tissue Exposure
- 6-7 Probability Distribution of Blood Lead Levels - Site 36 Crab Tissue Exposure

- 7-1 Flowchart of Potential Exposure Pathways and Ecological Receptors
- 7-2 Quotient Indices that Exceed "1" in Surface Water and Sediment

LIST OF ACRONYMS AND ABBREVIATIONS

AET	Apparent Effects Threshold
AQUIRE	Aquatic Information Retrieval Database
ARAR	Applicable or Relevant and Appropriate Requirement
AST	Above Ground Storage Tank
ASTM	American Society for Testing and Materials
ATSDR	Agency for Toxic Substances and Disease Registry
AWQC	Ambient Water Quality Criteria
BaB	Baymeade
Baker	Baker Environmental, Incorporated
Bb	Beef Biotransfer Factor
BCF	Bioconcentration Factor
BEHP	Bis(2-ethylhexyl)phthalate
bgs	Below Ground Surface
BI	Biotic Index
Br	Plant Biotransfer Factor (fruit)
BRA	Baseline Human Health Risk Assessment
BTEX	Benzene, Toluene, Ethylbenzene, and Xylene
Bv	Plant Biotransfer Factor (leaf)
°C	Degrees Celsius
Carc.	Carcinogenic Effects
CDI	Chronic Daily Intake
CERCLA	Comprehensive Environmental Response, Compensation and Liability Act
CLEJ	Camp Lejeune
CLP	Contract Laboratory Program
COC	Contaminant of Concern
COPC	Contaminant of Potential Concern
CRAVE	Carcinogen Risk Assessment Verification Endeavor
CRDL	Contract Required Detection Limit
CRQL	Contract Required Quantitation Limit
CSF	Carcinogenic Slope Factor
DC	Direct Current
DEM	Division of Environmental Management
DO	Dissolved Oxygen
DOD	Department of the Defense
DoN	Department of the Navy
DQO	Data Quality Objective
EDB	Ethyl Dibromide
EMD	Environmental Management Division (Camp Lejeune)
EPIC	Environmental Photographic Interpretation Center
ER-L	Effects Range - Low
ER-M	Effects Range - Median
ERA	Ecological Risk Assessment
ESE	Environmental Science and Engineering

LIST OF ACRONYMS AND ABBREVIATIONS
(Continued)

°F	Degrees Fahrenheit
FFA	Federal Facilities Agreement
FID	Flame Ionization Detector
ft	Feet
FWS	Fish and Wildlife Service
gpm	Gallons per Minute
GW	Groundwater Well
H'	Species Diversity (Shannon-Wiener)
H	Species Diversity (Brillouins')
HA	Health Advisories
HEAST	Health Effects Assessment Summary Tables
HHAG	Human Health Assessment Group
HI	Hazard Index
HPIA	Hadnot Point Industrial Area
HQ	Hazard Quotient
IAS	Initial Assessment Study
ICR	Estimated Incremental Lifetime Cancer Risk
ID	Internal Diameter
IDW	Investigation Derived Waste
IRIS	Integrated Risk Information System
IRP	Installation Restoration Program
K_{oc}	Organic Carbon Partition Coefficient
K_{ow}	Octanol Water Partition Coefficient
LANTDIV	Naval Facilities Engineering Command, Atlantic Division
LOAEL	Lowest-Observed-Adverse-Effect-Level
MAG	Marine Air Groups
MBI	Macroinvertebrate Biotic Index
MCAS	Marine Corps Air Station
MCB	Marine Corps Base
MCL	Maximum Contaminant Level
MEK	Methyl Ethyl Ketone
MF	Modifying Factor
mg/L	Milligrams per Liter
mg/kg	Milligrams per Kilogram
MI	Mobility Index
MIBK	Methyl Isobutyl Ketone
MS/MSD	Matrix Spike and Matrix Spike Duplicate
msl	Mean Sea Level

LIST OF ACRONYMS AND ABBREVIATIONS
(Continued)

NC DEHNR	North Carolina Department of Environment, Health, and Natural Resources
NCP	National Contingency Plan
NCWQS	North Carolina Water Quality Standards
ND	Nondetect
NEESA	Naval Energy and Environmental Support Activity
NEHC	Navy Environmental Health Center
NFESC	Naval Facilities Engineering Service Center
NOAA	National Oceanic and Atmospheric Administration
NOAEL	No-Observed-Adverse-Effect-Level
NOEL	No-Observed-Effect Level
Noncarc.	Noncarcinogenic Effects
NPL	National Priorities List
NWI	National Wetlands Inventory
O&G	Oil and Grease
ORNL	Oak Ridge National Laboratory
OSWER	Office of Solid Waste and Emergency Response
OU	Operable Unit
PAH	Polynuclear Aromatic Hydrocarbon
PCB	Polychlorinated Biphenyl
PID	Photoionization Detector
ppb	Parts per Billion
ppm	Parts per Million
PVC	Polyvinyl Chloride
QA/QC	Quality Assurance/Quality Control
QI	Quotient Index
R	Retardation Factor
RA	Risk Assessment
RBC	Region III Risk-Based Concentration
RCRA	Resource Conservation and Recovery Act
RfD	Reference Dose
RI/FS	Remedial Investigation/Feasibility Study
RI	Remedial Investigation
RME	Reasonable Maximum Exposure
ROD	Record of Decision
S	Solubility
SA	Site Assessment
SAP	Sampling and Analysis Plan
SCS	Soil Conservation Service
SD	Sediment
SI	Suite Investigation
Sj	Jaccard Coefficient

LIST OF ACRONYMS AND ABBREVIATIONS
(Continued)

SM-SP	Fine Sand and Loamy Fine Sand
SMCL	Secondary Maximum Contaminant Level
SOP	Standard Operating Procedure
SQC	Sediment Quality Criteria
S _s	Sørensen Index
SSL	Sediment Screening Level
SSV	Sediment Screening Value
SSSV	Surface Soil Screening Value
STP	Sewage Treatment Plant
SU	Standard Unit
SVOC	Semivolatile Organic Compound
SW	Surface Water
SWSV	Surface Water Screening Value
TAL	Target Analyte List
TBC	To Be Considered
TCE	Trichloroethylene
TCL	Target Compound List
TCLP	Toxicity Characteristic Leaching Procedure
TDS	Total Dissolved Solids
TIC	Tentatively Identified Compound
TOC	Total Organic Carbon
TOC	Top-of-Casing
TPH	Total Petroleum Hydrocarbon
TRV	Terrestrial Reference Value
TSS	Total Suspended Solids
µg/L	Micrograms per Liter
µg/g	Micrograms per Gram
µg/kg	Micrograms per Kilogram
UBK	Uptake/Biokinetics
UCL	Upper Confidence Limit
UF	Uncertainty Factor
USCS	Unified Soil Classification System
USEPA	United States Environmental Protection Agency
USGS	United States Geological Survey
UST	Underground Storage Tank
VOC	Volatile Organic Compound
VP	Vapor Pressure
WAR	Water and Air Research, Incorporated
WOE	Weight-of-Evidence
WQS	Water Quality Standards
WQSV	Water Quality Screening Values

EXECUTIVE SUMMARY

INTRODUCTION

The purpose of an RI is to evaluate the nature and extent of the threat to public health and the environment caused by the release or threatened release of hazardous substances, pollutants, or contaminants. This RI investigation was conducted through the sampling of several environmental media (soil, groundwater, surface water, sediment, and fish tissue) at OU No. 6, evaluating the resultant analytical data, and performing a human health risk assessment (RA) and ecological RA. This RI report contains the results of all field investigations, the human health RA, and the ecological RA. Furthermore, the RI report provides information to support the FS and Record of Decision (ROD) documents.

Operable Unit Description

OU No. 6 is located within the northwest portion of the facility, to the south and east of Camp Geiger Development Area. Site 36 is referred to as the "Camp Geiger Area Dump," Site 43 is the "Agan Street Dump," Site 44 is known as the "Jones Street Dump," Site 54 is the "Crash Crew Fire Training Burn Pit," and Site 86 is known as the "Tank Area AS419-AS421 at MCAS."

Site Description and Location

The Camp Geiger Area Dump (Site 36) is located approximately 1,000 feet east of Camp Geiger and 500 feet west of the New River, adjacent to the Camp Geiger Sewage Treatment Plant (STP). Camp Geiger is situated directly north of MCAS, New River, approximately 3 miles southwest of Jacksonville, North Carolina.

During an initial assessment of potential sites at MCB, Camp Lejeune, Site 36 was estimated to be approximately 1.5 acres in size (ESE, 1990). The Former Disposal Area was first identified in the IAS report as the Site 36 study area. Based upon a review of aerial photographs and observations recorded during the RI site scoping visit, the size of the site was adjusted to include nearly 20 acres. The site is comprised primarily of open fields and wooded areas with dense understory. A gravel road bisects the site and provides access to Jack's Point Recreation Area, located approximately one-quarter mile east of the study area. The site is bordered to the north and east by Brinson Creek and woods, to the east by woods, to the south by an unnamed tributary to the New River, and to the west by an improved (i.e., coarse gravel) road. Further to the west of the improved road lies an abandoned railroad right-of-way, once part of the Seaboard Coastline Railroad.

Site 36 is reported to have been used for the disposal of municipal wastes and mixed industrial wastes including trash, waste oils, solvents, and hydraulic fluids that were generated at MCAS, New River. The dump was active from the late 1940s to the late 1950s. Most of the material was first burned and then buried, however, some unburned material was buried. According to interviews conducted by Water and Air Research, Inc. (WAR) during the Initial Assessment Study (IAS), less than five percent of all waste hydrocarbon material generated at the air station was disposed of at Site 36. The remaining waste oil was reportedly used for dust control on roads or went directly into storm drains (WAR, 1983).

GEOLOGY

A fairly consistent depositional sequence was observed in borings throughout Site 36. This observed sequence is similar to the generalized North Carolina coastal plain sequence. The uppermost beds are undifferentiated. The surficial aquifer lies within the sediments of this undifferentiated formation. Less permeable sediments below the undifferentiated formation comprise the Belgrade Formation, also called the Castle Hayne confining unit. According to Cardinell et al., 1993, the Belgrade Formation constitutes part of the surficial aquifer and Castle Hayne confining unit. In this report for the purpose of simplicity, the less permeable sediments below the undifferentiated formation will be referred to as a distance unit; the Belgrade Formation (Castle Hayne confining unit). The River Bend Formation lies below the Belgrade Formation and is primarily characterized by beds of partially cemented shell fragments. The upper portion of the Castle Hayne aquifer lies within sediments of the River Bend Formation. The generalized sequence shows that the Yorktown, Eastover, and Pungo River Formations lies between the undifferentiated and Belgrade Formation. However, the Yorktown, Eastover, and Pungo River Formations have not been identified at Camp Lejeune.

Much of the surface soil and sediment at the site has been disturbed by human activity, as evidenced by mounds, ridges, roads, and cleared areas observed throughout the site. Additionally, debris and soil have been disposed on portions of the site that resulted in the ridge and mound areas. Generally, regraded soil and debris were encountered in borings in the southern portion of Site 36. The soil was observed to be predominantly sand, silt and clay, with a lesser amount of debris. The debris included rocks, glass, metal, bricks and wood.

The uppermost formation at Site 36, the undifferentiated Formation, is comprised of several units of Holocene and Pleistocene ages. This formation typically extends to a depth between 30 and 40 feet bgs. A fine sand, with lesser amounts of silt and clay occupies the uppermost portion of the formation. This sand unit is typically 5 feet thick. Below the sand is a clay layer with lesser amounts of fine sand and silt, approximately 2 to 5 feet thick. A second fine sand layer is below the clay. Zones of medium and coarse sand are present within this second sand unit. This sand unit also contains a lesser amount of silt and clay, and is approximately 5 to 15 feet thick. Additionally, laminae features are distinct in some portions of the unit. A unit composed of predominantly shell fragments lies below the second sand. This unit also contains of a lesser amount of fine sand, silt, and clay. This unit occupies the lower portion of the formation, and is 15 to 20 feet thick. The sands of the undifferentiated Formation tend to be loose to medium dense, the clays are soft to medium stiff, and the shell fragment layer is dense to very dense.

The Belgrade Formation is comprised of fine sand with lesser amounts of shell fragments, silt, and clay of the Miocene age. The top of this formation lies 30 to 40 feet bgs, is 15 to 20 feet thick, and has a distinct green or greenish-gray color. The sediments of this formation are medium dense to dense.

The River Bend Formation is comprised of fine to medium sand, with lesser amounts of shell fragments, silt, and clay of the Oligocene age. This formation lies approximately 60 feet bgs at Site 36. The sediments of this formation are very dense.

HYDROGEOLOGY

There are several aquifers beneath Site 36 and vicinity. The upper two aquifers were investigated in this study, the surficial and Castle Hayne. The surficial aquifer occurs within the sediments of the undifferentiated Formation within 10 feet of the surface. It is approximately 25 to 30 feet thick in the vicinity of Site 36 and is under unconfined conditions (i.e., water table aquifer). The upper portion of the Castle Hayne aquifer occurs within the sediments of the River Bend Formation. The Castle Hayne aquifer occurs approximately 60 feet bgs and is approximately 200 feet thick in the vicinity of Camp Geiger and the Air Station (Cardinell et al., 1993). The Belgrade Formation, situated between the undifferentiated and River Bend Formations is also known as the Castle Hayne confining unit. The Castle Hayne confining unit is approximately 17 to 23 feet thick at Site 36.

The surficial aquifer hydraulic conductivity values are an order of magnitude lower than the value presented in the Cardinell's report. The average hydraulic conductivity at Site 36, based on RI slug tests is 2.4 feet²/day, compared to 50 feet²/day presented by Cardinell. Cardinell provided an estimated hydraulic conductivity value of 50 feet²/day based on a general composition of fine sand, mixed with some silt and clay. The average hydraulic conductivity and transmissivity for the Castle Hayne aquifer at Site 36 is 5.7 feet²/day and 1,248 feet²/day, respectively. Cardinell's report presents hydraulic conductivities and transmissivities from several studies. Hydraulic conductivities range from 14 to 91 feet²/day and transmissivities range from 820 to 26,000 feet²/day. The RI results for Site 36 are comparable with other sites throughout Camp Lejeune.

Groundwater flow in the surficial aquifer at Site 36 is toward Brinson Creek east of the site, with an average velocity of 0.1 feet/day. Groundwater flow in the upper Castle Hayne aquifer is to the northeast, with an average velocity of 0.3 feet/day. Because the hydraulic conductivity varies, groundwater may exhibit preferential flow paths following the relatively highly conductive medium and coarse sands. There appears to be some degree of connection between the surficial and Castle Hayne aquifers.

Brinson Creek and the unnamed tributary, represent a groundwater flow boundary for the surficial aquifer at Site 36. It appears that groundwater in the surficial aquifer discharges to Brinson Creek based on the elevation of the creek relative to groundwater elevations and groundwater flow direction.

Groundwater flow in the upper 10 to 15 feet of the surficial aquifer is complicated by the presence of a clayey layer under much of the site. The position of the clay layer roughly corresponds to the water table. During drilling, water was observed in sands and silts above the clay in the western portion of the site. It appears that water infiltrating the sands and silts is slow to infiltrate around/through the clay layer, creating a thin, perched groundwater zone. This perched zone may be seasonal. Baker personnel observed a significant amount of rain prior to the start of field activities. Many low-lying areas of the site contained ponded water or saturated soils. Additionally, the perched zone was typically less than 1 foot thick, and limited in extent. No perched zone was evident during drilling in the eastern portion of the site. There, the depth to groundwater tended to be within or below the clay unit.

REMEDIAL INVESTIGATION ACTIVITIES

The field investigation program at OU No. 6, Site 36, was initiated to detect and characterize potential impacts to human health and the environment resulting from past waste management

activities. This section discusses the site-specific RI field investigation activities that were conducted to fulfill the objective. The RI field investigation of OU No. 6 commenced on February 20, 1995 and continued through May 10, 1995. An additional deep monitoring well was installed and a second round of groundwater samples were collected from a total of seven wells in July of 1995. A total of five additional soil borings and two sediment samples were collected in October of 1995 to confirm the presence of contamination encountered during the initial investigation. The RI field program at Site 36 consisted of a site survey; a soil investigation, which included drilling and sampling; a groundwater investigation, which included monitoring well installation, sampling, and aquifer testing; a surface water and sediment investigation; an aquatic investigation; and a habitat evaluation. The following sections detail the various investigation activities carried out during the RI.

A total of 67 borings were advanced to assess suspected waste disposal at Site 36; 8 of those borings were utilized for the installation of monitoring wells. Nine of the boring locations were advanced within the Former Disposal Area, identified in the IAS report, including one monitoring well test boring. A total of 14 soil borings and one monitoring well test boring were advanced within a cleared area located in the southwestern portion of the study area. Within the northern portion of Site 36, soil samples from six borings and three monitoring well test borings were collected. Six soil borings and one monitoring well test boring were completed in the open field located in the central portion of Site 36. The remaining soil borings were completed at the various locations throughout the site. Three additional borings, to the west of the study area, were advanced to assess background contaminant concentrations (36-BB-SB01, 36-BB-SB02, and 36-BB-SB03).

The analytical program initiated during the soil investigation at Site 36 focused on the suspected contaminants of concern, as indicated by information regarding previous disposal practices. Soils collected from the former disposal areas were analyzed for the full TCL organics (i.e., volatile, semivolatile, pesticide, and PCB fractions) and TAL metals as were samples obtained from monitoring well test borings. Additional soil borings and monitoring well test borings, located within the northern portion of the study area, were analyzed for TCL volatiles and TCL semivolatiles only. Five of the nine additional borings placed in the vicinity of 36-OA-SB01 were analyzed for pesticides and PCBs only.

In addition to analyzing for the contaminants of concern, one composite soil sample was collected for analysis of engineering parameters (i.e., particle size, and Atterberg limits). The engineering sample was comprised of individual grab samples collected from the ground surface to the water table. Soil samples from selected exploratory test pits were submitted for laboratory analysis of the compounds reported as part of TCLP and RCRA hazardous waste characteristics. Laboratory confirmation analysis of excavated soil was requested when staining was evident or when organic contamination was indicated by field screening. The TCLP samples were employed to characterize the nature of the visually contaminated material. Samples were prepared and handled as described in the previous section.

Round one groundwater samples were collected from five existing shallow wells (36-GW01 through 36-GW05), the six newly installed shallow wells (36-GW06 through 36-GW11), two temporary wells (36-TW01 and 36-TW02), and the three newly installed deep wells (36-GW06DW, 36-GW07DW, and 36-GW11DW) at Site 36.

The first groundwater sampling round, which included sample collection from existing and newly installed wells, was conducted at Site 36 in March of 1995. Based upon the analytical results

generated during the March sampling round, an additional three shallow (36-GW12, 36-GW13, and 36-GW14) and three intermediate monitoring wells (36-GW10IW, 36-GW12IW, and 36-GW13IW) were installed in April and sampled in May of 1995.

A second round of groundwater sampling was performed in July of 1995 that included the sampling of one newly installed deep monitoring well (36-GW10DW) and the resampling of the supplemental monitoring wells installed in April. The second round was conducted to confirm the presence of VOCs detected in samples retained from the northern portion of the study area.

Groundwater samples from five existing shallow wells, six newly installed shallow wells, three newly installed deep wells, and two temporary wells were analyzed as part of the first sampling round. During the first round, samples were analyzed for full TCL organics, TAL total metals, total suspended solids (TSS), and total dissolved solids (TDS). During a supplemental sampling round in May 1995, groundwater samples from three additional shallow and three additional intermediate wells were analyzed for TCL volatiles, TAL total metals, TSS, and TDS. During each of the sampling rounds, a limited number of samples were also analyzed for TAL dissolved metals.

Groundwater samples from three shallow wells, three intermediate wells, and a newly installed deep well were again analyzed during a second sampling round. The second sampling round focused on the presence of VOCs that were initially detected in the northern portion of the study area. The groundwater samples were analyzed using Contract Laboratory Program (CLP) protocols and Level III data quality.

A total of 7 surface water and 14 sediment samples were collected at Site 36 with each sampling station yielding one surface water and two sediment samples. Three of the sampling stations were located in Brinson Creek and four were located in an unnamed tributary to Brinson Creek. Based upon results of the initial investigation, two additional sediment samples were collected to confirm the presence of metal concentrations at location 36-SD06.

The analytical program at Site 36 was intended to assess the nature and extent of contamination in surface waters and sediments that may have resulted from past disposal practices. As a result, the analytical program focused on suspected contaminants of concern, based upon knowledge of suspected wastes and the overall quality of surface water and sediment. Both surface water and sediment samples were analyzed for full TCL organics and TAL metals. Surface water samples were also analyzed for TAL dissolved metals and hardness. In addition to organic and inorganic analyses, sediment samples were also analyzed for TOC and grain size. Two additional sediment stations, 36-SD08 and 36-SD09, were sampled for TAL metals only, based upon the detection of lead above federal standards in one of the initial samples from 36-SD06.

The analytical program at Site 36 was intended to accurately represent the nature of contamination in biotic organisms which may have resulted from past disposal practices at Site 36. The analytical program focused on suspected contaminants of concern and specie diversity. Fish tissue samples were analyzed for full TCL organics and TAL inorganics. A taxonomic identification of benthic macroinvertebrates was also performed.

During the habitat evaluation at Site 36, dominant vegetation types and species were identified in the field; those plants that could not be readily identified were collected for further examination in the office. Amphibians, reptiles, birds, and mammals were also identified as visual sightings or evidence allowed. In many cases, the animals themselves were not seen, but scat, tracks, feeding

areas, or remains were noted. From this information, ecological communities were established and biohabitat maps developed.

EXTENT OF CONTAMINATION

This section presents a summary of analytical findings from field sampling activities conducted at Site 36. Table ES-1 provides a summary of site contamination for Site 36.

Soils

VOCs and SVOCs detected in soil samples at Site 36 appear to be the most directly linked, among organic compounds, to past disposal practices. Several SVOCs were identified in both surface and subsurface soil samples obtained primarily from the eastern, southeastern, and central portions of the study area. A majority of SVOCs detected in soil samples were PAH compounds, which probably resulted from combustion of waste material or refuse. Several of the SVOCs were detected at concentrations greater than 1,000 µg/kg.

Inorganic analytes were detected in both surface and subsurface soil samples from the eastern portion of the study area at concentrations greater than one order of magnitude above twice the average base-specific background levels. In general, elevated metal concentrations were limited to soils obtained from the eastern, southeastern, and central portions of the study area. Copper, lead, and zinc were observed at maximum concentrations greater than two orders of magnitude above twice their average base-specific background levels. The same three metals had several positive detections in excess of the one order of magnitude level.

Dieldrin, 4,4'-DDE, 4,4'-DDD, and 4,4'-DDT appear to be the most widely scattered pesticides within soils at Site 36. Each of the four pesticides was detected in at least 35 of 103 soil samples. The pesticide 4,4'-DDE was the most prevalent, with 72 positive detections at concentrations ranging from 2.2 to 2,600 µg/kg in surface soil. The highest pesticide concentration was that of dieldrin at 16,000 µg/kg. In general, higher concentrations of those pesticides more frequently detected, were limited to the eastern and central portions of the study area, and in particular among borings 36-GW11, OA-SB05, and FDA-SB05. A number of maximum pesticide detections were also observed in samples from the western portion of the site, immediately surrounding OA-SB01.

Two PCBs, Aroclor-1248 and 1254, were detected in 14 soil samples obtained within a 30-foot diameter area surrounding OA-SB01 at Site 36. The maximum Aroclor-1248 concentration was 24,000 µg/kg in sample OA-SB01I. Two other PCB detections of Aroclor 1254 were observed in surface samples obtained from the central portion of the site.

Volatile compounds were found in surface and subsurface samples at concentrations generally lower than 20 µg/kg. Based upon their detection within areas reported or suspected of receiving waste and the number of years since disposal operations reportedly transpired, the occurrence of volatile compounds in soils at Site 36 appears to be the result of past disposal practices in specific portions of the study area. In general, volatile, semivolatile, and higher pesticide concentrations were observed in similar areas of the site.

TABLE ES-1

**SUMMARY OF SITE CONTAMINATION
SITE 36, CAMP GEIGER AREA DUMP
REMEDIAL INVESTIGATION, CTO-0303
MCB, CAMP LEJEUNE, NORTH CAROLINA**

Media	Fraction	Detected Contaminants	Comparison Criteria		Site Contamination				
			Standard	Base Background	Min.	Max.	Max. Location	Detection Frequency	Distribution
Surface Soil (1)	Volatiles	Trichloroethene	NA	NA	4	4	FDA-SB03	1/61	eastern, former disposal area
		Tetrachloroethene	NA	NA	2	3	36-GW12	3/61	northern, ground scar area
		Toluene	NA	NA	8	98	OF-SB01	4/61	south central, open field
		Styrene	NA	NA	39	39	GS-SB03	1/61	northern, ground scar area
		Xylene (total)	NA	NA	7	7	OF-SB06B	1/61	south central, open field
	Semivolatiles	n-Nitro-di-n-propylamine	NA	NA	320	320	DAB-SB03	1/57	southeastern, drum area
		Naphthalene (PAH)	NA	NA	48	120	OF-SB04	2/57	1 south central, 1 western
		2-Methylnaphthalene	NA	NA	54	82	OA-SB01A	2/57	1 south central, 1 western
		Acenaphthene (PAH)	NA	NA	330	330	OF-SB04	1/57	south central, open field
		Dibenzofuran	NA	NA	150	150	OF-SB04	1/57	south central, open field
		Fluorene (PAH)	NA	NA	200	200	OF-SB04	1/57	south central, open field
		Phenanthrene (PAH)	NA	NA	59	2,500	OF-SB04	4/57	scattered
		Anthracene (PAH)	NA	NA	780	780	OF-SB04	1/57	south central, open field
		Carbazole	NA	NA	240	240	OF-SB04	1/57	south central, open field
		Fluoranthene (PAH)	NA	NA	54	5,500	OF-SB04	5/57	4 southeastern, drum area
		Pyrene (PAH)	NA	NA	41	11,000	OF-SB04	8/57	5 southeastern, drum area
		Butylbenzylphthalate	NA	NA	51	290	OA-SB03	3/57	western
		B(a)anthracene (PAH)	NA	NA	46	3,900	OF-SB04	2/57	1 south central, 1 southeastern
		Chrysene (PAH)	NA	NA	51	4,600	OF-SB04	5/57	3 southeastern, drum area
		B(b)fluoranthene (PAH)	NA	NA	51	3,600	OF-SB04	3/57	scattered
		B(k)fluoranthene (PAH)	NA	NA	39	1,500	OF-SB04	2/57	1 south central, 1 southeastern
		Benzo(a)pyrene (PAH)	NA	NA	40	3,300	OF-SB04	2/57	1 south central, 1 western
		I(1,2,3-cd)pyrene (PAH)	NA	NA	46	2,700	OF-SB04	3/57	scattered
D(a,h)anthracene (PAH)	NA	NA	720	720	OF-SB04	1/57	south central, open field		
B(g,h,i)perylene (PAH)	NA	NA	2,400	2,400	OF-SB04	1/57	south central, open field		

TABLE ES-1 (Continued)

SUMMARY OF SITE CONTAMINATION
 SITE 36, CAMP GEIGER AREA DUMP
 REMEDIAL INVESTIGATION, CTO-0303
 MCB, CAMP LEJEUNE, NORTH CAROLINA

Media	Fraction	Detected Contaminants	Comparison Criteria		Site Contamination				
			Standard	Base Background	Min.	Max.	Max. Location	Detection Frequency	Distribution
Surface Soil (Continued)	Pesticides	gamma-BHC (Lindane)	NA	NA	4.0	4.0	OF-SB06D	1/57	south central, open field
		Heptachlor	NA	NA	1.9	1.9	FCA-SB12	1/57	southwestern, former cleared area
		Aldrin	NA	NA	5.5	1,400	OF-SB03	3/57	1 open field, 2 adjacent to SB01
		Heptachlor epoxide	NA	NA	2	67	OA-SB01I	10/57	scattered, 3 adjacent to SB01
		Endosulfan I	NA	NA	8.3	36	OA-SB01E	3/57	all adjacent to SB01
		Dieldrin	NA	NA	2	16,000	OF-SB03	21/57	scattered
		4-4'-DDE	NA	NA	2.2	2,600	OA-SB01A	49/57	widely scattered, prevalent
		Endrin	NA	NA	9.9	9.9	OA-SB08	1/57	eastern, former disposal area
		4-4'-DDD	NA	NA	2.8	550	OA-SB01A	37/57	widely scattered, prevalent
		Endosulfan Sulfate	NA	NA	2.5	4.2	OF-SB06	2/57	1 south central, 1 western
		4-4'-DDT	NA	NA	1.8	12,000	OA-SB01A	48/57	widely scattered, prevalent
		Endrin Ketone	NA	NA	15	15	OF-SB03	1/57	south central, open field
		Endrin aldehyde	NA	NA	12	12	OF-SB02	1/57	south central, open field
		alpha-Chlordane	NA	NA	1.2	980	OA-SB05	15/57	scattered
	gamma-Chlordane	NA	NA	1.2	840	OA-SB05	10/57	scattered	
	PCBs	Aroclor 1248	NA	NA	68	24,000	OA-SB01I	9/57	western, surrounding SB01
		Aroclor 1254	NA	NA	92	530	OA-SB01	3/57	western, surrounding SB01
	Metals (2)	Antimony	NA	5.3	3.3	31.7	OA-SB08	7/46	5 exceed BB, scattered
		Arsenic	NA	1.3	0.4	10.4	OA-SB08	43/52	22 exceed BB, scattered
		Cadmium	NA	0.7	0.7	6.3	OA-SB08	8/52	7 exceed BB, scattered
		Chromium	NA	6.7	1.6	51.6	OA-SB08	52/52	27 exceed BB, scattered
		Copper	NA	7.2	0.6	445	OA-SB08	39/52	25 exceed BB, scattered
		Lead	NA	23.7	4.3	836	OA-SB08	48/52	24 exceed BB, scattered
Mercury		NA	0.1	0.1	2.4	OA-SB05	18/52	18 exceed BB, scattered	
Nickel		NA	3.4	1	48.3	OA-SB08	26/52	13 exceed BB, scattered	
Silver	NA	0.9	0.6	12	OF-SB04	8/48	5 exceed BB, 3 south central		
Zinc	NA	13.9	2.1	1,320	OA-SB08	50/52	34 exceed BB, scattered		

TABLE ES-1 (Continued)

**SUMMARY OF SITE CONTAMINATION
SITE 36, CAMP GEIGER AREA DUMP
REMEDIAL INVESTIGATION, CTO-0303
MCB, CAMP LEJEUNE, NORTH CAROLINA**

Media	Fraction	Detected Contaminants	Comparison Criteria		Site Contamination				
			Standard	Base Background	Min.	Max.	Max. Location	Detection Frequency	Distribution
Subsurface Soil	Volatiles	Acetone	NA	NA	12	480	GS-SB03	8/62	1 exceeds blank, ground scar area
		1,2-Dichloroethene (total)	NA	NA	4	4	OA-SB01	1/62	western
		Trichloroethene	NA	NA	3	5	FDA-SB01	3/62	2 eastern, 1 western
		Benzene	NA	NA	3	3	FDA-SB01	1/62	eastern, former disposal area
		Toluene	NA	NA	5	17	OF-SB06	5/62	south central, open field
		Xylene (total)	NA	NA	2	6	FDA-SB06	8/62	scattered
	Semivolatiles	1,4-Dichlorobenzene	NA	NA	97	97	DAB-SB02	1/57	southeastern, drum area
		2-Methylphenol	NA	NA	510	510	DAB-SB01	1/58	southeastern, drum area
		4-Methylphenol	NA	NA	43	43	DAB-SB01	1/58	southeastern, drum area
		Isophorone	NA	NA	2,100	2,100	DAB-SB01	1/58	southeastern, drum area
		Naphthalene (PAH)	NA	NA	41	41	OA-SB01A	1/57	western
		2-Methylnaphthalene	NA	NA	65	85	FDA-SB02	2/57	1 eastern, 1 western
		Phenanthrene (PAH)	NA	NA	48	190	OA-SB07	3/57	scattered
		Di-n-butylphtalate	NA	NA	56	56	OA-SB01	1/58	western
		Fluoranthene (PAH)	NA	NA	130	320	OA-SB07	3/57	2 eastern, 1 south central
		Pyrene (PAH)	NA	NA	59	320	OA-SB07	5/57	scattered
		Butylbenzylphtalate	NA	NA	42	170	OA-SB03	3/57	scattered
		B(a)anthracene (PAH)	NA	NA	69	140	OA-SB07	3/57	scattered
		Chrysene (PAH)	NA	NA	41	200	OA-SB07	5/57	3 eastern, former disposal area
		B(b)fluoranthene (PAH)	NA	NA	44	170	OA-SB07	5/57	4 eastern, 1 south central
		B(k)fluoranthene (PAH)	NA	NA	42	68	OA-SB07	3/57	eastern, former disposal area
		Benzo(a)pyrene (PAH)	NA	NA	72	450	GS-SB03	4/57	3 eastern, 1 northern
		I(1,2,3-cd)pyrene (PAH)	NA	NA	48	110	OA-SB07	3/57	eastern, former disposal area
B(g,h,i)perylene (PAH)	NA	NA	42	89	OA-SB07	2/57	eastern, former disposal area		

TABLE ES-1 (Continued)

**SUMMARY OF SITE CONTAMINATION
SITE 36, CAMP GEIGER AREA DUMP
REMEDIAL INVESTIGATION, CTO-0303
MCB, CAMP LEJEUNE, NORTH CAROLINA**

Media	Fraction	Detected Contaminants	Comparison Criteria		Site Contamination				
			Standard	Base Background	Min.	Max.	Max. Location	Detection Frequency	Distribution
Subsurface Soil (Continued)	Pesticides	gamma-BHC (Lindane)	NA	NA	4	4	OF-SB06D	1/56	open field
		Aldrin	NA	NA	1.5	16	36-GW11	5/56	3 southeastern, 2 eastern
		Heptachlor Epoxide	NA	NA	3.4	14	36-GW11	3/56	3 eastern, former disposal area
		Dieldrin	NA	NA	2.2	1,200	FDA-SB05	17/56	scattered
		4,4'-DDE	NA	NA	2.3	1,700	OA-SB01A	29/56	widely scattered, prevalent
		Endrin	NA	NA	2.4	5	OF-SB06B	5/56	scattered
		Endosulfan II	NA	NA	2.0	2.0	OF-SB06B	1/56	south central, open field
		4,4'-DDD	NA	NA	2.3	1,300	FDA-SB05	30/56	widely scattered, prevalent
		4,4'-DDT	NA	NA	2.8	3,100	OA-SB01A	28/56	widely scattered, prevalent
		Endrin Aldehyde	NA	NA	3.5	32	FDA-SB05	3/56	2 south central, 1 eastern
		alpha-Chlordane	NA	NA	1.6	750	36-GW11	12/56	primarily eastern
	gamma-Chlordane	NA	NA	2.3	770	36-GW11	9/56	primarily eastern	
	PCBs	Aroclor 1248	NA	NA	19	850	OA-SB01	5/56	western, adjacent to SB01
	Metals (2)	Antimony	NA	6.4	4.9	21.6	36-GW11	7/44	3 exceed BB, eastern
		Arsenic	NA	1.9	0.2	25.9	FDA-SB01	41/51	18 exceed BB, eastern and central
		Cadmium	NA	0.7	0.7	42.8	36-GW11	11/51	9 exceed BB, eastern and central
		Chromium	NA	12.6	1.4	71.9	36-GW11	50/51	14 exceed BB, eastern and central
		Copper	NA	2.4	0.5	1,320	OF-SB06B	31/51	25 exceed BB, scattered
		Lead	NA	8.3	1.2	2,680	OA-SB07	50/51	32 exceed BB, scattered
		Mercury	NA	0.1	0.1	3.9	OA-SB07	13/51	12 exceed BB, east/southeastern
Nickel		NA	3.7	1.1	72.1	DAD-SB02	24/51	19 exceed BB, scattered	
Selenium		NA	0.8	0.4	1.2	OF-SB06	4/51	1 exceeds BB, southcentral	
Zinc	NA	6.7	0.9	2,580	FDA-SB05	41/51	28 exceed BB, scattered		
Groundwater	Volatiles (3)	Methylene Chloride	NCWQS - 5	NA	1	1	36-GW10	1/29	does not exceed standard
		1,2-Dichloroethene (total)	MCL - 70	NA	4	37	36-GW10IW	8/29	none exceed standard
		Trichloroethene	NCWQS - 2.8	NA	3	97	36-GW10IW	10/29	10 exceed standard, 8 northern
		Tetrachloroethene	NCWQS - 0.7	NA	1	2	36-GW10IW	2/29	both exceed standard, northern
		1,1,2,2-Tetrachloroethane	NA	NA	3	10	36-GW10IW	6/29	northern, former ground scar area

TABLE ES-1 (Continued)

**SUMMARY OF SITE CONTAMINATION
SITE 36, CAMP GEIGER AREA DUMP
REMEDIAL INVESTIGATION, CTO-0303
MCB, CAMP LEJEUNE, NORTH CAROLINA**

Media	Fraction	Detected Contaminants	Comparison Criteria		Site Contamination					
			Standard	Base Background	Min.	Max.	Max. Location	Detection Frequency	Distribution	
Groundwater (Continued)	Semivolatiles	ND	NCWQS/MCL	NA					0/17	
	Pesticides	4,4'-DDD	NA	NA	0.06	0.06	36-GW10	1/18	northern, during Round One only	
	PCBs	ND	NCWQS/MCL	NA				0/18		
	Total Metals	Iron		NCWQS - 300	NA	3.3	16,900	36-GW02	20/22	12 exceed standard, scattered
		Manganese		NCWQS - 50	NA	19.2	3,180	36-GW09	20/22	12 exceed standard, scattered
		Mercury		NCWQS - 1.1	NA	1.4	1.4	36-TW02	1/22	1 exceeds standard, southern
Surface Water (4)	Volatiles	1,2-Dichloroethene (total)	NCWQS - 7.0	NA	7	7	36-SW02	1/7	UT, upgradient of open field	
	Semivolatiles	ND	NCWQS/NOAA	NA				0/7		
	Pesticides	ND	NCWQS/NOAA	NA				0/7		
	PCBs	ND	NCWQS/NOAA	NA				0/7		
		Metals (5)	Copper	NCWQS - 3.0	129	56.5	56.5	36-SW01	1/7	1 exceeds standard, not BB
			Iron	NOAA - 1,000	1416	967	4840	36-SW03	7/7	3 exceed standard and BB
	Nickel		NCWQS - 8.3	ND	16.4	31.4	36-SW02	4/7	4 exceed standard	
Sediment	Volatiles	Tetrachloroethane	NA	NA	4	4	36-SD04	1/13	near mouth of UT at BC	
	Semivolatiles	Diethylphthalate	NA	NA	330	2,135	36-SD05	3/13	UT and near mouth of UT	
		Anthracene	NOAA - 85	NA	46	46	36-SD04	1/13	does not exceed standard, UT	
		Di-n-butylphthalate	NA	NA	218	218	36-SD06	1/13	BC, adjacent to ground scar area	
		Pyrene (PAH)	NOAA - 350	NA	316	316	36-SD02	1/13	UT, does not exceed standard	
	Pesticides	Aldrin	NA	NA	0.9	0.9	36-SD01	1/13	UT, upgradient	
		Dieldrin	NA	NA	0.8	52	36-SD06	3/13	2 from BC, minimum from UT	
		4,4'-DDE	NOAA - 2	NA	32	1,200	36-SD05	9/13	9 exceed standard, higher in BC	
		Endrin	NOAA - 0.02	NA	6.6	6.6	36-SD02	1/13	UT, upgradient of open field	
		4,4'-DDD	NOAA - 2	NA	14	1,140	36-SD05	12/13	12 exceed standard	
		Endosulfan Sulfate	NA	NA	3	3	36-SD02	1/13	UT, upgradient of open field	
		4,4'-DDT	NOAA - 1	NA	3	46	36-SD05	11/13	11 exceed standard	
		Endrin Ketone	NA	NA	11	11	36-SD03	1/13	UT, adjacent to open field	
		Endrin Aldehyde	NA	NA	3.5	7.6	36-SD05	2/13	1 from BC, 1 from UT	
		alpha-Chlordane	NOAA - 0.5	NA	6.5	13	36-SD07	2/13	2 exceed standard, upgradient BC	

TABLE ES-1 (Continued)

SUMMARY OF SITE CONTAMINATION
 SITE 36, CAMP GEIGER AREA DUMP
 REMEDIAL INVESTIGATION, CTO-0303
 MCB, CAMP LEJEUNE, NORTH CAROLINA

Media	Fraction	Detected Contaminants	Comparison Criteria		Site Contamination				
			Standard	Base Background	Min.	Max.	Max. Location	Detection Frequency	Distribution
Sediment (Continued)	PCBs	ND	NOAA	NA				0/13	
	Metals (5)	Cadmium	NOAA - 5	1.3	1.4	8.7	36-SD02	2/15	1 exceeds standard and BB, UT
		Lead	NOAA - 35	314	7.1	15,100	36-SD06	12/15	7 exceed standard, 1 exceeds BB
		Mercury	NOAA - 0.15	ND	0.2	0.7	36-SD04	3/4	3 exceed standard, 11 rejected
		Nickel	NOAA - 30	6.0	2.1	77.1	36-SD03	11/15	1 exceeds standard, from UT
Zinc	NOAA - 120	926	25.3	140	36-SD02	5/5	1 exceeds standard, not BB, UT		

Notes:

- Concentrations are presented in µg/L for liquid and µg/Kg for solids (ppb), metal concentrations for soils and sediments are presented in mg/Kg (ppm).

- (1) Detection frequencies for surface soil do not include confirmatory, unvalidated, analytical results from samples collected in May 1996.
- (2) Metals in both surface and subsurface soils were compared to twice the average base background positive concentrations for priority pollutant metals only (i.e., antimony, arsenic, beryllium, cadmium, chromium, copper, lead, mercury, nickel, selenium, silver, thallium, zinc).
- (3) An additional round of groundwater samples were collected from wells which exhibited concentrations of volatiles during the first round.
- (4) Surface water detections were compared to appropriate NCWQS and NOAA screening values, based upon the observed percentage of saltwater at each sampling location.
- (5) Total metals in surface water and sediment were compared to the maximum positive detections in upgradient samples at MCB, Camp Lejeune.

BB - Base background, value equals two times average value for soil and the maximum value for surface water and sediment (refer to Appendix P)

BC - Brinson Creek

BEHP - bis(2-ethylhexyl)phthalate

NA - Not applicable

NCWQS - North Carolina Water Quality Standard

ND - Not detected

NOAA - National Oceanic and Atmospheric Administration

MCL - Federal Maximum Contaminant Level

PAH - Polynuclear aromatic hydrocarbon

UT - Unnamed Tributary

ES-12

Groundwater

Inorganics were the most prevalent and widely distributed constituents detected in both shallow and deep groundwater at Site 36. Concentrations of TAL total metals were generally higher in groundwater samples from the shallow aquifer than in samples collected from the deeper aquifer. Iron and manganese were the most prevalent inorganic analytes, detected at concentrations that exceeded state standards within 12 groundwater samples.

Positive detections of organic compounds were limited to the northern and western portions of the study area. The presence of volatile compounds in the northern portion of the study area, as indicated by the initial round of sampling results, were confirmed by results of the second sampling round. Six positive detections of trichloroethene from four separate monitoring wells exceeded the NCWQS of 5 µg/L. The maximum trichloroethene detection was 97 µg/L from well 36-GW10IW collected during the second sampling round.

Surface Water

Brinson Creek

Ten of 23 TAL total metals were positively identified in the three surface water samples obtained from Brinson Creek (36-SW05, 36-SW06, and 36-SW07). None of the positive metal detections exceeded either state or federal standards for surface water. Positive detections of metals were compared to contaminant standards for water bodies classified as tidally influenced (i.e., containing at least five percent saltwater).

Unnamed Tributary

A positive detection of one volatile organic compound was observed among the four surface water samples retained from the unnamed tributary. The VOC 1,2-dichloroethene was detected at a concentration of 7 µg/L in sample 36-SW02, located adjacent to the southwestern portion of study area near an unimproved vehicle access road.

Laboratory analyses of four surface water samples retained from the unnamed tributary indicate that 14 of 23 total metals were positively detected. Copper, iron, and nickel were the only metals identified at concentrations in excess of either NCWQS screening values or National Oceanic and Atmospheric Administration (NOAA) chronic screening values. Nickel was detected at a concentration in excess of the 8.3 µg/L NOAA saltwater screening value in the surface water sample obtained from 36-SW04. Sampling station 36-SW04 was considered tidally influenced and, therefore, results were compared to saltwater screening values; results from stations 36-SW01, 36-SW02, and 36-SW03 were compared to freshwater screening values. Copper was detected only once among the entire sample set from an upgradient sampling station. The concentration of copper at 36-SW01 was 56.5 µg/L, which exceeded the NOM standard of 6.5 µg/L. However, this copper detection did not exceed the maximum base-specific surface water background concentration of 129 µg/L. Iron was detected in each of the samples collected from both Brinson Creek and the unnamed tributary. Positive detections of iron at the three freshwater sampling stations exceeded the 1,000 µg/L screening value and the 1,416 µg/L maximum base-specific background concentration. No other total metal concentrations in the four surface water samples exceeded state or federal screening values.

Sediments

Brinson Creek

VOCs were not detected among the samples analyzed from Brinson Creek. Diethylphthalate and di-n-butylphthalate were each detected once among the six sediment samples, at concentrations of 2,135 and 218 µg/kg. No other SVOCs were detected in sediment samples.

The pesticides 4,4'-DDE, 4,4'-DDD, and 4,4'-DDT were each detected in at least five of the six Brinson Creek sediment samples. Each of the three pesticides were detected at their respective maximum concentrations within a sample retained from station 36-SD05, located adjacent to the mouth of an unnamed tributary that borders the southern portion of the site. As indicated in Table ES-1, each of the detections were in excess of NOAA Effects Range-Low (ER-L) screening values. Detections of the three most frequently detected organic pesticide compounds ranged from 3 µg/kg of 4,4'-DDT to 1,200 µg/kg of 4,4'-DDE. The pesticides dieldrin, endrin aldehyde, and alpha-chlordane were also detected among the six sediment samples from Brinson Creek. Alpha-chlordane was observed in two samples from an upstream sampling location at concentrations of 6.5 and 13 µg/kg, which exceeded the NOAA screening value of 0.5 µg/kg. Dieldrin was detected twice among samples retained from Brinson Creek at concentrations of 0.8 and 52 µg/kg. Endrin aldehyde was detected once among the six sediment samples at a concentration of 7.6 µg/kg.

Nineteen of 23 TAL total metals were positively identified in the ten Brinson Creek sediment samples (antimony, cadmium, selenium, and silver were not detected; six of eight mercury and zinc analyses were rejected). Lead and mercury were identified at concentrations in excess of their respective NOAA screening values. The two detections of mercury from Brinson Creek exceeded the 0.15 mg/kg sediment screening value. Three detections of lead among eight samples from Brinson Creek exceeded the 35 mg/kg standard. Only one of the three lead detections exceeded the base background concentration. Lead was detected at a concentration of 15,100 mg/kg at sample station 36-SD06, located adjacent to the former wharf on Brinson Creek. This concentration of lead represents an exceedance of the NOAA screening value by more than two orders of magnitude. Two supplemental samples (36-SD08 and 36-SD09) were later collected from the former wharf area to confirm the presence of lead; however, lead was not detected in excess of the 35 mg/kg standard.

Unnamed Tributary

Tetrachloroethane was the only volatile organic compound detected among the 7 unnamed tributary sediment samples. Tetrachloroethane was identified at a concentration of 4 µg/kg within sample 36-SD04, collected approximately 100 feet upstream of Brinson Creek.

Three SVOCs were identified within sediment samples obtained in the unnamed tributary. Diethylphthalate, anthracene, and pyrene were detected among the seven samples retained from the unnamed tributary. The maximum semivolatile concentration, 896 µg/kg, was that of diethylphthalate. Diethylphthalate was positively detected within two of the seven samples. Anthracene and pyrene were detected only once among the unnamed tributary samples submitted for laboratory analysis. None of the detections exceeded applicable NOAA screening values.

The pesticides 4,4'-DDD, and 4,4'-DDT were each detected in six of the seven unnamed tributary sediment samples. As indicated in Table 4-14, 4,4'-DDD and 4,4'-DDT were detected at maximum concentrations of 1,030 and 27 µg/kg. The pesticide 4,4'-DDE was detected within three of the seven samples at a maximum concentration of 169 µg/kg. The maximum concentrations of both 4,4'-DDD and 4,4'-DDE were detected in samples obtained at sampling location 36-SD03. The pesticides aldrin, dieldrin, endrin, endosulfan sulfate, endrin ketone, and endrin aldehyde were detected once among the seven sediment samples from the unnamed tributary. The maximum concentrations of these pesticides ranged from 0.8 µg/kg of dieldrin to 11 µg/kg of endrin ketone.

Twenty of 23 TAL total metals were positively identified in the seven sediment samples from the unnamed tributary (antimony, selenium, and silver were not detected; five of the seven mercury and zinc detections were rejected). Cadmium, lead, mercury, nickel, and zinc were each identified at concentrations in excess of NOAA ER-L screening values. Each of the five metal analytes were detected in excess of sediment screening values in at least one of the unnamed tributary samples. Lead was detected with the greatest frequency among the sample set and at concentrations that exceeded the NOAA screening value of 35 mg/kg in four of the seven samples. Concentrations of lead in samples retained from the unnamed tributary ranged from 17.9 to 148 mg/kg. A single detection of cadmium, mercury, nickel, and zinc exceeded NOAA screening values. All concentrations of TAL metals detected in sediment samples from the unnamed tributary were within base-specific background concentrations, however.

HUMAN HEALTH RISK ASSESSMENT

At Site 36, exposure to surface soil, surface water and sediment was assessed for the current trespassers. Military receptors were assessed only for surface soil risks. Fish and crab tissue ingestion was only evaluated for the fisherman. Subsurface soil, groundwater, surface water, and sediment exposure were evaluated for the future receptors.

In the current case, the following receptors were assessed: military personnel, fishermen, recreational users of the site surface water, trespassers, and a construction worker. Receptor exposure to surface soil, surface water, sediment, fish tissue, and crab tissue were evaluated. The potential risks associated with the current receptors, excluding the fisherman, were within acceptable risk levels. For the current fisherman, the total noncarcinogenic risk (9.1) and total carcinogenic risk (1.1×10^{-3}), mainly from fish and crab tissue ingestion, were greater than the acceptable risk levels of one and 1×10^{-4} for noncarcinogenic and carcinogenic effects, respectively. The levels of arsenic and mercury found in the fish tissue and the maximum levels of arsenic and lead detected in the crab tissue impacted these risks. In terms of lead effects, exposure to the maximum concentration of lead in the surface soil and crab tissue for a child receptor indicates the potential for adverse health effects.

The maximum level of arsenic was detected once in a white catfish fillet sample. The maximum level of mercury was found in a largemouth bass fillet sample. These two samples represent fish typically caught and ingested by residents of the area. Crabbing may be less prevalent than recreational fishing in the area, because access to the site surface water where crabs are more abundant is limited. These metals were also detected in the underlying sediment. However, they were not found in the surrounding surface water.

In the future case, child and adult residents were assessed for potential exposure to groundwater, subsurface soil, surface water, and sediment. A construction worker was evaluated for subsurface soil exposure. There were no unacceptable risks associated with the construction worker. However, there were potential noncarcinogenic risks calculated for the child resident from groundwater (5.2) and subsurface soil (2.3) exposure. Similarly, there was a noncarcinogenic risk (2.2) calculated for the adult resident from groundwater exposure. These risk values exceeded the acceptable risk value of one for noncarcinogenic effects. The maximum level of iron in groundwater contributed to these risks. In terms of lead effects, exposure to the maximum concentration of lead in the subsurface soil for a child receptor indicates the potential for adverse health effects.

As stated previously, groundwater is not currently used potably at the site. Future residential development of the site is unlikely. Based on this information, the future groundwater exposure scenario evaluated in this BRA, although highly protective of human health, is unlikely to occur.

As explained in Section 3.0 of this report, groundwater in the MCB Camp Lejeune area is naturally rich in iron. Metals are also prevalent in the site soils. There is no record of any historical-use of iron at Site 36. Consequently, it is assumed that iron is a naturally-occurring inorganic in groundwater and soil, and its presence is not attributable to site operations.

Iron is an essential nutrient. The toxicity values associated with exposure to this metal are based on provisional studies, which have not been verified by USEPA. In fact, if iron were removed from the evaluation of risk from groundwater ingestion, the noncarcinogenic risk for the child would decrease from 5.1 to 1.5 and, for the adult, from 2.2 to 0.7, which is an acceptable noncarcinogenic risk value. The noncarcinogenic risk from exposure to subsurface soil for the child receptor would decrease to acceptable risk value (i.e., 2.2 to 0.9) if iron were removed from the evaluation. As a result, the potential human health risk from exposure to iron in groundwater and subsurface soil is a conservative and unrealistic estimate.

ECOLOGICAL RISK ASSESSMENT

Aquatic Ecosystem

As presented earlier in the ERA, the assessment endpoints for the aquatic receptors are changes in the structure of benthic macroinvertebrate communities attributable to site-related contaminants and the potential reduction of an aquatic receptor population or subpopulation that is attributable to site related contaminants. These assessment endpoints were evaluated using a series of measurement endpoints. This section of the ERA examines each of the measurement endpoints to determine if the assessment endpoints are impacted.

The first measurement endpoint is lower benthic macroinvertebrate species diversity and richness in the Site 36 stations when compared to an ecologically similar background location. Overall, there were more benthic macroinvertebrate species and individuals, and higher species diversity at the three Site 36 stations, compared to the upstream Brinson Creek stations and the off-site reference station. The MBI was high at all the stations, indicating that a large percentage of species were pollution-tolerant. In addition, the species diversity and density at the Site 36 stations were similar to or higher than the study conducted in the Pamlico River Estuary, North Carolina. Therefore, it appears that the benthic macroinvertebrate community at Site 36 is representative of the benthic macroinvertebrate community that is expected based on the habitat, salinity, and regional comparisons.

The second measurement endpoint is determining if the Site 36 benthic macroinvertebrates are dominated by contaminant-tolerant species as opposed to contaminant-sensitive species. The MBI was high at all the stations (including the upstream stations), indicating that a large percentage of species were pollution-tolerant. However, in the Pamlico River Estuary study, the comparable stations (based on salinity) were dominated by Rangia cuneata and Nereis succinea (Tenore, 1971). The three Site 36 stations were dominated by Nereis succinea (40.9%, 63.5%, and 49.5%).

The third measurement endpoint is determining if the contaminant levels in the Site 36 biota tissue samples is elevated when compared to tissue samples collected at off-site background stations or in the literature. Several of the contaminants detected in the fish and crab tissues appeared to be slightly elevated. However, based on the relatively abundant and diverse fish population in Brinson Creek, these contaminants do not appear to be significantly impacting the fish community.

The fourth measurement endpoint is determining if the contaminant levels in the Site 36 fish tissue samples exceed toxicity values in the literature. Chlordane and arsenic was the only contaminant detected in the fish tissue samples for which toxicity data was located in the literature. Chlordane and arsenic were detected at a concentration in the fish tissue below the reported toxicity concentration. In addition, it should be noted that the concentration of cadmium and chromium were detected at concentrations below those reported as indicative of contamination.

The last measurement endpoint is determining if the contaminant concentrations in the surface water and sediment exceed the contaminant-specific surface water and sediment effect concentrations (i.e., SWSVs, and SSVs).

There is a slight potential for metals in the surface water and sediment, and a moderate potential for pesticides (4,4'-DDD and 4,4'-DDT) and diethylphthalate in the sediment, to decrease in the population of aquatic life at the freshwater stations. There is a very slight potential for metals in the surface water (copper, nickel), and a moderate potential for metals (lead), pesticides (4,4'-DDD, and 4,4'-DDE) and diethylphthalate in the sediment, to decrease the population of aquatic life at the saltwater stations. Pesticides reportedly have not been stored or disposed at Site 36. Therefore, the probable source of the pesticides in the sediment is the wide-spread application of pesticides that was conducted at MCB Camp Lejeune.

The high lead concentration in the sediment was detected at the sample collected adjacently to the site (36-SD06). The source of the high lead concentration is not known. However, based on additional sediment sampling, it appears that the high lead concentration in 36-SD06 may have been an anomaly, and does not appear to be indicative of actual site concentrations.

Overall, the contaminants in the surface water and sediment have a slight potential to reduce the aquatic receptor population in the freshwater stations. There is a very slight potential for metals in the surface water (copper, nickel), and a moderate potential for metals (lead), pesticides (4,4'-DDD, and 4,4'-DDE) and diethylphthalate in the sediment, to decrease the population of aquatic life at the saltwater stations. The benthic macroinvertebrates do not appear to be impacted based on the results of the sampling events. Some of the contaminants in the fish tissue are elevated. However, due to the lack of toxicological data, the potential risk to the fish from those contaminants cannot be evaluated.

Terrestrial Ecosystem

As presented earlier in the ERA, the assessment endpoints for the terrestrial receptors is the potential reduction of a receptor population or subpopulation that is attributable to contaminants from the site. This section evaluates this assessment endpoint using the measurement endpoints.

The first measurement endpoint is determining if there is an exceedance of contaminant-specific soil effect concentrations (i.e., SSSVs). Several contaminants were detected at concentrations in the surface soil that exceed the SSSVs.

The second measurement endpoint is determining if the terrestrial CDI exceeds the TRVs. The CDI exceeds the TRV for the all five terrestrial species. However, the risk is higher for the cottontail rabbit and raccoon. The risks to these species are due to a few contaminants with relatively low QIs, not one specific contaminant driving the risk.

Finally, the last measurement endpoint is determining if the tissue sample concentrations exceed proposed criteria for piscivorous wildlife. Aldrin, dieldrin, 4,4'-DDD, and 4,4'-DDE are the only pesticides detected in the whole body fish tissue samples at concentrations above the proposed piscivorous wildlife criteria. Some of these pesticides may have accumulated from the pesticides detected in the sediment at Site 36. None of the pesticides caused a risk in the raccoon from ingesting the fish. Lead in the fish and crabs were slightly elevated versus the background samples. However, it did not cause a risk to the raccoon ingesting the fish. Cadmium was only metal detected in the whole-body tissue samples above the wildlife dietary levels that posed a risk to the raccoon. However, the cadmium in the tissue samples does not appear to be site-related.

Overall, some potential impacts to soil invertebrates and plants may occur as a result of site-related contaminants. It should be noted that there is much uncertainty in the SSSVs. There is a slight potential for decrease in the terrestrial vertebrate population from site-related contaminants based on the terrestrial intake model.

1.0 INTRODUCTION

Marine Corps Base (MCB), Camp Lejeune was placed on the Comprehensive Environmental Response, Compensation, and Liability Act (CERCLA) National Priorities List (NPL) on October 4, 1989 (54 Federal Register 41015, October 4, 1989). Subsequent to this listing, the United States Environmental Protection Agency (USEPA) Region IV; the North Carolina Department of Environment, Health and Natural Resources (NC DEHNR); and the United States Department of the Navy (DoN) entered into a Federal Facilities Agreement (FFA) for MCB, Camp Lejeune. The primary purpose of the FFA is to ensure that environmental impacts associated with past and present activities at MCB, Camp Lejeune are thoroughly investigated and appropriate CERCLA response/Resource Conservation and Recovery Act (RCRA) corrective action alternatives are developed and implemented, as necessary, to protect public health, welfare, and the environment (FFA, 1989).

The Fiscal Year 1996 Site Management Plan for MCB, Camp Lejeune, the primary document referenced in the FFA, identifies 33 sites that require Remedial Investigation/Feasibility Study (RI/FS) activities. These 33 sites have been divided into 16 operable units to simplify RI/FS activities. An RI was conducted at Operable Unit (OU) No. 6, Sites 36, 43, 44, 54, and 86, during February through May of 1995. This report describes the RI conducted at Site 36. Four additional reports have been prepared that address each of the other OU No. 6 sites. Figure 1-1 depicts the location of the five sites that comprise OU No. 6. [Note that all tables and figures are presented in the back of each section.]

The purpose of an RI is to evaluate the nature and extent of the threat to public health and the environment caused by the release or threatened release of hazardous substances, pollutants, or contaminants. This RI investigation was conducted through the sampling of several environmental media (soil, groundwater, surface water, sediment, and fish tissue) at OU No. 6, evaluating the resultant analytical data, and performing a human health risk assessment (RA) and ecological RA. This RI report contains the results of all field investigations, the human health RA, and the ecological RA. Furthermore, the RI report provides information to support the FS and Record of Decision (ROD) documents.

This RI Report has been prepared by Baker Environmental, Inc. (Baker) and submitted to the USEPA Region IV; the NC DEHNR; MCB, Camp Lejeune Environmental Management Department (EMD); the Navy Environmental Health Center (NEHC); the Agency for Toxic Substances and Disease Registry; and to the Naval Facilities Engineering Command, Atlantic Division (LANTDIV) for their review.

The following subsections describe the arrangement of OU No. 6 and the background and setting of both MCB, Camp Lejeune and Site 36. In addition, Section 1.1 provides an overview of the RI report's organization.

1.1 Report Organization

This RI Report is comprised of one text volume with appendices provided in an additional volume. The following section headings are included within this text volume and provide site-specific investigation findings:

- Study Area Investigation - Section 2.0
- Site Physical Characteristics - Section 3.0
- Nature and Extent of Contamination - Section 4.0
- Contaminant Fate and Transport - Section 5.0
- Baseline Human Health Risk Assessment - Section 6.0
- Ecological Risk Assessment - Section 7.0
- Conclusions - Section 8.0

1.2 Background and Setting of MCB, Camp Lejeune

This section summarizes existing background and setting information pertaining to MCB, Camp Lejeune. The text specifically addresses the location and setting of MCB, Camp Lejeune, its history, topography, geology, hydrogeology, climatology, ecology, land use, and demography.

1.2.1 Location and Setting

MCB, Camp Lejeune is located on the coastal plain of North Carolina in Onslow County. The facility encompasses approximately 234 square miles and is bisected by the New River. The New River flows in a southeasterly direction and forms a large estuary before entering the Atlantic Ocean. The southeastern border of MCB, Camp Lejeune is the Atlantic Ocean shoreline. The western and northeastern boundaries of the facility are U.S. Route 17 and State Route 24, respectively. The City of Jacksonville borders MCB, Camp Lejeune to the north (refer to Figure 1-1).

1.2.2 History

Construction of MCB, Camp Lejeune began in April 1941 at the Hadnot Point Industrial Area (HPIA), where major functions of the base are centered today. The facility was designed to be the "World's Most Complete Amphibious Training Base." The MCB, Camp Lejeune complex consists of five geographical locations under the jurisdiction of the Base Command. These areas include Camp Geiger, Montford Point, Courthouse Bay, Mainside, and the Rifle Range Area. Site 36 is located within the Camp Geiger operations area. The remaining four of the five sites that comprise OU No. 6 are located within the Marine Corps Air Station (MCAS), New River operations area. Although MCAS New River is under the jurisdiction of a separate command (i.e., MCAS, Cherry Point), environmental compliance issues and Installation Restoration Program (IRP) sites are the responsibility of MCB, Camp Lejeune EMD.

1.2.3 Operable Unit Description

Operable units are formed as an incremental step toward addressing individual site concerns. There are currently 33 IRP sites at MCB, Camp Lejeune, which have been grouped into 16 operable units. Due to the similar nature of suspected waste and their close proximity to one another, Sites 36, 43, 44, 54, and 86 were grouped together as OU No. 6. Figure 1-2 depicts the locations of all 16 operable units at MCB, Camp Lejeune.

OU No. 6 is located within the northwest portion of the facility, to the south and east of Camp Geiger Development Area. Site 36 is referred to as the "Camp Geiger Area Dump," Site 43 is the "Agan Street Dump," Site 44 is known as the "Jones Street Dump," Site 54 is the "Crash Crew Fire Training Burn Pit," and Site 86 is known as the "Above Ground Storage Tank Area."

1.2.4 Topography

The flat topography of MCB, Camp Lejeune is typical of seaward portions of the North Carolina coastal plain. Elevations on the base vary from sea level to 72 feet above mean sea level (msl); however, most of MCB, Camp Lejeune is between 20 and 40 feet above msl.

Drainage at MCB, Camp Lejeune is generally toward the New River, except in areas near the coast where flow is into the Intracoastal Waterway that lies between the mainland and barrier islands. In developed areas of the facility, natural drainage has been altered by asphalt cover, storm sewers, and drainage ditches. Approximately 70 percent of MCB, Camp Lejeune is comprised of broad, flat interstream areas with poor drainage (WAR, 1983).

1.2.5 Surface Water Hydrology

The dominant surface water feature at MCB, Camp Lejeune is the New River. It receives drainage from a majority of the base. The New River is short with a course of approximately 50 miles on the central Coastal Plain of North Carolina. Over most of its length, the New River is confined to a relatively narrow channel in Eocene and Oligocene limestones. South of Jacksonville, the river widens dramatically as it flows across less resistant sands, clays, and marls. At MCB, Camp Lejeune, the New River flows in a southerly direction into the Atlantic Ocean through the New River Inlet. Several small coastal creeks drain the area of MCB, Camp Lejeune not associated with the New River and its tributaries. These creeks flow into the Intracoastal Waterway, which is connected to the Atlantic Ocean by Bear Inlet, Brown's Inlet, and the New River Inlet. The New River, the Intracoastal Waterway, and the Atlantic Ocean converge at the New River Inlet.

Water quality criteria for surface waters in North Carolina have been published under Title 15 of the North Carolina Administrative Code. At MCB, Camp Lejeune, the New River falls into two classifications: SC (estuarine waters not suited for body-contact sports or commercial shellfishing); and SA (estuarine waters suited for commercial shellfishing). The SC classification applies to only three areas of the New River at MCB, Camp Lejeune; the rest of the New River at MCB, Camp Lejeune falls into the SA classification (ESE, 1990).

1.2.6 Geology

MCB, Camp Lejeune is located within the Atlantic Coastal Plain physiographic province. The sediments of this province consist primarily of sand, silt, and clay. Other sediments may be present, including shell beds and gravel. Sediments may be of marine or continental origin. These sediments are found in interfingering beds and lenses that gently dip and thicken to the southeast. Sediments of this type range in age from early Cretaceous to Quaternary time and overlie igneous and metamorphic rocks of pre-Cretaceous age. Table 1-1 presents a generalized stratigraphic column for the Atlantic Coastal Plain of North Carolina (Harned et. al., 1989).

United States Geological Survey (USGS) studies at MCB, Camp Lejeune indicate that the base is underlain by sand, silt, clay, calcareous clay and partially cemented limestone. The combined thickness of these sediments beneath the base is approximately 1,500 feet.

1.2.7 Hydrogeology

The aquifers of primary interest are the surficial aquifer and the aquifer immediately below it, the Castle Hayne Aquifer. Other aquifers that occur beneath the facility include the Beaufort, Peedee, Black Creek, and upper and lower Cape Fear aquifers. The following summary is a compilation of information which pertains to aquifer characteristics within the MCB, Camp Lejeune area. A generalized hydrogeologic cross-section illustrating the relationship between the aquifers in this area is presented in Figures 1-3 and 1-4.

The surficial aquifer consists of interfingering beds of sand, clay, sandy clay, and silt that contain some peat and shells. The thickness of the surficial aquifer ranges from 0 to 73 feet and averages nearly 25 feet over the MCB, Camp Lejeune area. It is generally thickest in the interstream divide areas and presumed absent where it is cut by the New River and its tributaries. The beds are thin and discontinuous, and have limited lateral continuity. This aquifer is not used for water supply at MCB, Camp Lejeune.

The general lithology of the surficial aquifer and the absence of any thick, continuous clay beds are indications of relatively high vertical conductivity within the aquifer. The estimated lateral hydraulic conductivity of the surficial aquifer in the MCB, Camp Lejeune area is 50 feet per day, and is based on a general composition of fine sand mixed with some silt and clay (Harned et al., 1989). However, data from a number of slug tests conducted by Baker at sites near OU No. 6 indicate much lower lateral hydraulic conductivity values. These values range from 7.2×10^{-4} feet per day to 6.4 feet per day. Table 1-2 presents a summary of hydraulic properties compiled during investigations at other sites located within the developed portion of MCAS, New River.

Between the surficial and the Castle Hayne aquifers lies the Castle Hayne confining unit. This unit consists of clay, silt, and sandy clay beds. In general, the Castle Hayne confining unit may be characterized as a group of less permeable beds at the top of the Castle Hayne aquifer that have been partly eroded or incised in places. The Castle Hayne confining unit is discontinuous, and has a thickness ranging from 0 to 26 feet, averaging about 9 feet where present. There is no discernable trend in the thickness of the confining unit seen in these or related investigations, nor is there any information in the USGS literature regarding any trend of the depth of the confining unit.

Previously recorded data indicate that vertical hydraulic conductivity of the confining unit ranged from 0.0014 to 0.41 feet per day (Cardinell et al., 1993). Data obtained from a pump test conducted by ESE indicated a vertical hydraulic conductivity for this unit ranging from 1.4×10^{-3} to 5.1×10^{-2} feet per day (ESE, 1988). Based on the moderate conductivity values and the thin, discontinuous nature of the confining unit, this unit may only be partly effective in retarding the downward vertical movement of groundwater from the surficial aquifer.

The Castle Hayne aquifer lies below the surficial aquifer and consists primarily of unconsolidated sand, shell fragments, and fossiliferous limestone. Clay, silt, silty and sandy clay, and indurated limestone also occur within the aquifer. The upper part of the aquifer consists primarily of calcareous sand with some continuous and discontinuous thin clay and silt beds. The calcareous sand becomes more limey with depth. The lower part of the aquifer consists of consolidated or poorly consolidated limestone and sandy limestone interbedded with clay and sand.

The Castle Hayne aquifer is about 150 to 350 feet thick, increasing in thickness toward the ocean. The top of the aquifer lies approximately 20 to 73 feet below the ground surface. The top of the

aquifer dips southward and is deepest near the Atlantic coast, east of the New River. The top of the aquifer also forms a basin in the vicinity of Paradise Point. Estimates of hydraulic conductivity indicate a wide variation in range, from 14 to 91 feet per day. Table 1-3 presents estimates of the Castle Hayne aquifer and confining unit hydraulic properties in the vicinity of MCB, Camp Lejeune.

Onslow County and MCB, Camp Lejeune lie in an area where the Castle Hayne aquifer generally contains freshwater; however, the proximity of saltwater in deeper layers just below the aquifer and in the New River estuary is of concern in managing water withdrawals. Over-pumping of the deeper parts of the aquifer could cause encroachment of saltwater. The aquifer generally contains water having less than 250 milligrams per liter (mg/L) chloride throughout the base, except for one USGS well in the southern portion of the base that is screened in the lower portion of the aquifer. Chloride was measured at 960 mg/L in a sample collected in 1989 from this well.

Rainfall in the MCB, Camp Lejeune area enters the ground in recharge areas, infiltrates the soil, and moves downward until it reaches the surficial aquifer. Recharge areas at Camp Lejeune are mainly comprised of interstream areas. In the surficial aquifer, groundwater flows in the direction of lower hydraulic head until it reaches discharge points or fronts. These discharge areas include the New River and its tributaries and the ocean. Though most of the rainfall entering the surficial aquifer discharges to local streams, a relatively small amount infiltrates to the Castle Hayne. The surficial aquifer supplies the primary recharge to the Castle Hayne aquifer. Like the surficial aquifer, the Castle Hayne naturally discharges to the New River and major tributaries; however, pumping of the Castle Hayne may locally influence flow directions.

The potentiometric surface of the surficial aquifer varies seasonally, as seen through the observation of water levels in monitoring wells. The surficial aquifer receives more recharge in the winter than in the summer when much of the water evaporates or is transpired by plants before it can reach the water table. As a result, the potentiometric surface is generally highest in the winter months and lowest in the summer or early fall.

Water levels from wells placed in deeper aquifers, such as the Castle Hayne, were also used to establish potentiometric surfaces. Because the Castle Hayne is at least partially confined from the surficial aquifer and is not influenced by rainfall as strongly as the surficial aquifer, the seasonal variations tend to be slower and smaller than in surficial aquifer.

1.2.8 Ecology

The ecology at MCB Camp Lejeune is discussed in three sections that include ecological communities, sensitive environments and threatened and endangered species.

1.2.8.1 Ecological Communities

MCB, Camp Lejeune is located on North Carolina's coastal plain. A number of natural ecological communities are present within this region. In addition, variations of natural communities have occurred in response to disturbance and intervention (e.g., forest clearing, urbanization). The natural communities found in the area are summarized as follows:

- Mixed Hardwood Forest - Found generally on slopes of ravines. Beech, white oak, tulip, sweetgum, and holly are indicator species.

- Southeastern Evergreen Forest - Dominated by pines, especially longleaf pine.
- Loblolly Pine/Hardwoods Community - Second growth forest that includes loblolly pine with a mix of hardwoods (i.e., oak, hickory, sweetgum, sour gum, red maple, and holly).
- Southern Floodplain Forest - Occurs on the floodplains of rivers. Hardwoods dominate with a variety of species present. Composition of species varies with the amount of moisture.
- Maritime Forest - Develops on the lee side of stable sand dunes protected from the ocean. Live oak is an indicator species along with pine, cedar, yaupon, holly, and laurel oak. Deciduous hardwoods may be present where forest is mature.
- Pocosins - Lowland forest community that develops on highly organic soils that are seasonally flooded. Characterized by plants adapted to drought and acidic soils low in nutrients. Pond pine is the dominant tree with dense layer of evergreen shrubs. Strongly influenced by fire.
- Cypress Tupelo Swamp Forest - Occurs in the lowest and wettest areas of floodplains. Dominated by bald cypress and tupelo.
- Freshwater Marsh - Occurs upstream from tidal marshes and downstream from non-tidal freshwater wetlands. Cattails, sedges, and rushes are present.
- Salt Marsh - Regularly flooded, tidally influenced areas dominated by salt-tolerant grasses. Saltwater cordgrass is a characteristic species. Tidal mud flats may be present during low tide.
- Salt Shrub Thicket - High areas of salt marshes and beach areas behind dunes. Subjected to salt spray and periodic saltwater flooding. Dominated by salt resistant shrubs.
- Dunes/Beaches - Zones from the ocean shore to the maritime forest. Subjected to sand, salt, wind, and water.
- Ponds and Lakes - Low depressional areas where water table reaches the surface or where ground is impermeable. In ponds rooted plants can grow across the bottom. Fish populations in these ponds include reed, bluegill, largemouth bass, and channel catfish.
- Open Water - Marine and estuarine waters as well as all underlying bottoms below the intertidal zone.

MCB, Camp Lejeune covers approximately 150,000 acres or 234 square miles. Marine and estuarine open water account for 26,000 acres and terrestrial and palustrine land account for 85,000 acres. Forests are predominant as terrestrial cover and pine forest is the dominant habitat type. A total of 21,000 acres of the pine forest is loblolly pine, 7700 acres are dominated by longleaf pine

forest, and 3600 acres are dominated by pond pine forest. These pine forests include natural subcommunities that are maintained by fire.

In addition to the pine forest, mixed pine\hardwood forest is present on MCB, Camp Lejeune and accounts for 15,900 acres. An additional 12,100 acres are covered by hardwood forest. Of the wetlands present, estuarine marsh accounts for 700 acres; open freshwater accounts for 200 acres; and dune, beach, and brackish marsh accounts for 2200 acres. Industrial, infrastructure, and administrative areas make up 10,000 acres and artillery impact areas and buffer zones account for 11,000 acres (LeBlond, 1994). The base contains 80 miles of tidal streams, 21 miles of marine shoreline, and 12 freshwater ponds. The soil types range from sandy loams to fine sand and muck, with the dominant series being sandy loam (USMC,1987).

The base drains primarily to the New River via its tributaries. These tributaries include Northeast Creek, Southwest Creek, Cogdels Creek, Wallace Creek, Frenchs Creek, Bear Head Creek, Brinson Creek, Edwards Creek, and Duck Creek. Site-specific information regarding surface water and drainage features is presented in Section 2.0.

Forested areas within the military reservation are actively managed for timber. Game species are also managed for hunting and ponds are maintained for fishing. Game species managed include wild turkey, white-tailed deer, black bear, grey and fox squirrels, bobwhite quail, eastern cottontail and marsh rabbits, raccoons, and wood ducks. About 150 acres are maintained for wildlife food plots.

1.2.8.1 Sensitive Environments

Two areas on MCB, Camp Lejeune have been registered as designated Natural Areas within the North Carolina Natural Heritage Program. These two areas, which encompass 141 acres, are the Longleaf Pine Natural Area and the Wallace Creek Swamp Natural Area. In addition, 12 other Natural Areas have been recommended for inclusion in the registry.

These Natural Areas contain some of the finest examples of natural communities in North Carolina and support many rare species. A few of these community types are globally rare. The Calcareous Coastal Fringe Forest on the 100-acre midden at Corn Landing is the only known extant example of this community type. Camp Lejeune contains some of the best examples of the following globally-rare, natural community types: Cypress Savanna, Depression Meadow, and Small Depression Pond. The Maritime Evergreen Forest hammocks between Cedar Point and Shell Point are connected by shell tombolos and appear to be a very rare geological formation.

The NC DEHNR's Division of Environmental Management (DEM) has developed guidance pertaining to activities that may impact wetlands (NC DEHNR, 1992). In addition, certain activities affecting wetlands are also regulated by the U.S. Army Corps of Engineers.

The U.S. Fish and Wildlife Service (FWS) has prepared National Wetlands Inventory (NWI) maps for the MCB, Camp Lejeune area. Through stereoscopic analysis of high altitude aerial photographs, wetlands were identified based upon vegetation, visible hydrology, and geography in accordance with Classification of Wetland and Deep-Water Habitats of the United States (Cowardin, et al., 1979). The NWI maps are intended for an initial identification of wetland areas and are not meant to replace an actual wetland delineation survey that may be required by Federal, state and local regulatory agencies.

Site-specific wetland delineations were not conducted at Sites 36, 43, 44, 54, and 86; however, potential wetland areas were noted during the field habitat evaluation. Information regarding potential wetland areas was transferred to the site-specific biohabitat maps provided in Section 2.0. Information regarding sensitive natural areas was reviewed during map preparation and has been transferred to the maps, if applicable.

1.2.8.2 Threatened and Endangered Species

Certain species have been granted protection by the FWS under the Federal Endangered Species Act (16 U.S.C. 1531-1543), and by the North Carolina Wildlife Resources Commission, under the North Carolina Endangered Species Act (G.S. 113-331 to 113-337). The protected species fall into one of the following status classifications: federal or state endangered, threatened or candidate species; state special concern; state significantly rare; or state watch list. While only the federal or state threatened or endangered and state special concern species are protected from certain actions, the other classified species may have protection in the future.

Surveys have been conducted to identify threatened and endangered species at MCB, Camp Lejeune and several programs are underway to manage and protect them. Table 1-4 lists federally protected species present at the base and their protected classification. Of these species, the red-cockaded woodpecker, American alligator, and sea turtles are protected by specific regulatory programs.

The red-cockaded woodpecker requires a mature, living longleaf or loblolly pine environment. The birds live in family groups and young are raised cooperatively. At MCB, Camp Lejeune, 2,512 acres of habitat have been identified and marked for protection. Approximately 3,300 acres are in actively managed red-cockaded woodpecker colonies. Research on the bird at MCB, Camp Lejeune began in 1985 and information has been collected to determine home ranges, population size and composition, reproductive success, and habitat use. An annual roost survey is conducted and 36 colonies of birds have been located.

The American alligator is considered a state special concern specie. It is found in freshwater, estuarine, and saltwater wetlands in MCB, Camp Lejeune. Base wetlands are maintained and protected for alligators; signs have been posted where alligators are known to live. Annual surveys of Wallace, Southwest, French, Duck, Mill, and Stone Creeks have been conducted since 1977 to identify alligators and their habitats on base.

Two protected sea turtles, the Atlantic loggerhead and Atlantic green turtle, nest on Onslow Beach at MCB, Camp Lejeune. The green turtle was found nesting in 1980; this sighting was the first time the species had been observed nesting north of Georgia. The turtle returned to nest in 1985. Turtle nests on the beach are surveyed and protected, turtles are tagged, and annual turtle status reports are issued.

Three bird species, piping plover, Bachmans sparrow, and peregrine falcon have also been identified during surveys at MCB, Camp Lejeune. The piping plover is a shore bird. Piping plovers prefer beaches with broad open sandy flats above the high tide line and feed along the edge of incoming waves. Like the piping plover, Bachmans sparrows have very specific habitat requirements. The sparrows live in open stretches of pines with grasses and scattered shrubs for ground cover. Bachmans sparrows were observed at numerous locations throughout southern portion MCB, Camp Lejeune.

In addition to the protected species that breed or forage at MCB, Camp Lejeune, several protected whales migrate through the coastal waters off the base during spring and fall. These include the Atlantic right whale, finback whale, sei whale, and sperm whale. Before artillery or bombing practice is conducted in the area, aerial surveys are made to assure that whales are not present in the impact areas.

A natural heritage resource study was conducted at MCB, Camp Lejeune (LeBlond, 1994) to identify threatened or endangered plants and areas of significant natural interest. During the resource study 55 rare plant species were documented from Camp Lejeune. These include 1 specie that is classified as Federal Endangered, 1 specie that is classified as Federally Threatened, 9 that are candidates for federal listing as Endangered or Threatened, 4 that are listed as Endangered or Threatened in the State of North Carolina, and 27 species that are State Rare or State Special Concern. These species are summarized on Table 1-4. In addition, species that are candidates for state listing or are on the North Carolina state watch list were noted.

1.2.9 Land Use Demographics

MCB, Camp Lejeune encompasses an area of approximately 234 square miles. The Installation border is approximately 70 miles, including 21 miles of ocean front and Intracoastal Waterway. Recently, MCB, Camp Lejeune acquired approximately 41,000 additional acres in the Greater Sandy Run area. Table 1-5 provides a breakdown of land uses within the developed portion of the facility.

Land use within MCB, Camp Lejeune is influenced by topography and ground cover, environmental policy, and base operational requirements. Much of the land within MCB, Camp Lejeune consists of freshwater swamps that are wooded and largely unsuitable for development. In addition, 3,000 acres of sensitive estuary and other areas set aside for the protection of threatened and endangered species are to remain undeveloped. Operational restrictions and regulations, such as explosive quantity safety distances, impact-weighted noise thresholds, and aircraft landing and clearance zones, may also greatly constrain and influence development (Master Plan, 1988).

The combined military and civilian population of the MCB, Camp Lejeune and Jacksonville area is approximately 112,000. Nearly 90 percent of the surrounding population resides within urbanized areas. The presence of MCB, Camp Lejeune has been the single greatest factor contributing to the rapid population growth of Jacksonville and adjacent communities, particularly during the period from 1940 to 1960.

1.2.9.1 Camp Geiger

Camp Geiger, located directly north of MCAS, New River, contains a mixture of troop housing, personnel support and training facilities. Currently, the area is utilized by a number of groups which have no direct relationship to one another. The majority of the land surrounding this area is comprised of buffer zones and unbuildable marshland. Site 36 is situated within the Camp Geiger area.

A mixture of old and new facilities exists at Camp Geiger, the result of which is a patchwork of land use areas arranged in a north to south configuration. The evolution of the approximately 216 acres of development has resulted in uses that are not interrelated, physically or functionally.

Supply and storage facilities, which are concentrated along the eastern edge of the developed area and in the central portion, covers about 50 acres of land. Maintenance buildings, which cover about 19 acres, are located adjacent to the supply/storage areas. Combined, supply/storage and maintenance areas account for nearly 32 percent of the developed land in Camp Geiger.

No family housing exists at Camp Geiger. Troop housing (situated on 54 acres) is located in three areas, interspersed with community and commercial facilities. Training facilities tend to be conveniently accessible by foot from troop housing although less accessible from community areas, such as the dining facilities. The 16 acres of recreational facilities are scarce in terms of number and inconvenient in terms of access.

To comprehensively evaluate existing land use in this area it is important to examine the relationship of Camp Geiger to its neighbor to the south, the MCAS New River. Recent commercial and community development at the Curtis Road Triangle serves effectively to pull the orientation of Camp Geiger southward.

1.2.10 Meteorology

Although coastal North Carolina lacks distinct wet and dry seasons, there is some seasonal variation in average precipitation. July tends to receive the most precipitation, and rainfall amounts during summer are generally the greatest. Daily showers during the summer are not uncommon, nor are periods of one or two weeks without rain. Convective showers and thunderstorms contribute to the variability of precipitation during the summer months. October tends to receive the least amount of precipitation, on average. Throughout the winter and spring precipitation occurs primarily in the form of migratory low pressure storms. MCB, Camp Lejeune's average yearly rainfall is 52.4 inches. Table 1-6 presents a climatic summary of data collected during 35 years (January 1955 to December 1990) of observations at MCAS New River.

Coastal Plain temperatures are moderated by the proximity of the Atlantic Ocean, which effectively reduces the average daily fluctuation of temperature. Lying 50 miles offshore at its nearest point, the Gulf Stream tends to have little direct effect on coastal temperatures. The southern reaches of the cold Labrador Current offset any warming effect the Gulf Stream might otherwise provide.

MCB, Camp Lejeune experiences hot and humid summers; however, ocean breezes frequently produce a cooling effect. The winter months tend to be mild, with occasional brief cold spells. Average daily temperatures range from 34°F to 54°F in January, the coldest month, and 72°F to 89°F in July, the hottest month. The average relative humidity, between 78 and 89 percent, does not vary greatly from season to season.

Observations of sky conditions indicate yearly averages of approximately 112 days clear, 105 partly cloudy, and 148 cloudy. Measurable amounts of rainfall occur 118 days per year, on the average. Prevailing winds are generally from the south-southwest 10 months of the year and from the north-northwest during September and October. The average wind speed at MCAS, New River is seven miles per hour.

1.3 Background and Setting of Site 36

The following section provides both the location and setting of Site 36. A brief summary of past waste disposal activities at Site 36 is also provided within this section.

1.3.1 Site Location and Setting

The Camp Geiger Area Dump (Site 36) is located approximately 1,000 feet east of Camp Geiger and 500 feet west of the New River, adjacent to the Camp Geiger Sewage Treatment Plant (STP). Camp Geiger is situated directly north of MCAS, New River, approximately 3 miles southwest of Jacksonville, North Carolina (refer to Figure 1-1).

Figure 1-5 presents a site map of the Camp Geiger Area Dump. During an initial assessment of potential sites at MCB, Camp Lejeune, Site 36 was estimated to be approximately 1.5 acres in size (ESE, 1990). The Former Disposal Area, depicted on Figure 1-5, was first identified in the IAS report as the Site 36 study area. Based upon a review of aerial photographs and observations recorded during the RI site scoping visit, the size of the site was adjusted to include nearly 20 acres. The site is comprised primarily of open fields and wooded areas with dense understory. A gravel road bisects the site and provides access to Jack's Point Recreation Area, located approximately one-quarter mile east of the study area. The site is bordered to the north and east by Brinson Creek and woods, to the east by woods, to the south by an unnamed tributary to the New River, and to the west by an improved (i.e., coarse gravel) road. Further to the west of the improved road lies an abandoned railroad right-of-way, once part of the Seaboard Coastline Railroad.

1.3.2 Site History

Site 36 is reported to have been used for the disposal of municipal wastes and mixed industrial wastes including trash, waste oils, solvents, and hydraulic fluids that were generated at MCAS, New River. The dump was active from the late 1940s to the late 1950s. Most of the material was first burned and then buried, however, some unburned material was buried. According to interviews conducted by Water and Air Research, Inc. (WAR) during the Initial Assessment Study (IAS), less than five percent of all waste hydrocarbon material generated at the air station was disposed of at Site 36. The remaining waste oil was reportedly used for dust control on roads or went directly into storm drains (WAR, 1983).

1.4 Previous Investigations

The following subsections detail previous investigation activities at Site 36.

1.4.1 Initial Assessment Study

An IAS was conducted at Site 36 by WAR in 1983. The IAS evaluated the potential hazards at various sites throughout the base, including Site 36. The IAS was based upon review of historical records, aerial photographs, inspections, and personnel interviews. As a result of this process, the IAS recommended that a Confirmation Study be performed at Sites 36.

1.4.2 Confirmation Study

A two-part Confirmation Study was conducted at Site 36 by Environmental Science and Engineering (ESE) from 1984 through 1987. The Verification Step was performed in 1984 and the Confirmation Step was performed in 1986 and 1987. The Confirmation Study at Site 36 focused on the presence of potential contaminants in groundwater, surface water, and sediment. Findings from the Confirmation Study are provided below.

1.4.2.1 Groundwater Investigation

A total of five shallow groundwater monitoring wells (i.e., total depth less than 25 feet) were installed as part of the Confirmation Study. Four of the wells were installed and sampled in 1984, and resampled in 1986. Well 36-GW01 was placed on the southern side of the suspected disposal area. Wells 36-GW02 and 36-GW03 were situated to the east and northeast of the suspected disposal area, between the disposal area and Brinson Creek. Well 36-GW04 was installed as a background well, located approximately 300 feet to the west (upgradient) of the suspected disposal area. Well 36-GW05, installed and sampled in 1986 and sampled again in 1987, was also placed to the west of the study area as an additional upgradient monitoring point. Figure 1-6 depicts the locations of the five shallow monitoring wells installed between 1984 and 1986. Table 1-7 provides the well construction details of the five shallow wells. Groundwater samples collected during the Confirmation Study were analyzed for the following parameters:

- Cadmium
- Chromium
- Hexavalent chromium (1986/1987 only)
- Lead
- Volatile Organic Compounds (VOCs)
- Oil and Grease (O&G)
- Total Phenol
- Ethylene dibromide (EDB) (1986/1987 only)
- Xylenes (1986/1987 only)
- Methyl ethyl ketone (MEK) (1986/1987 only)
- Methyl isobutyl ketone (MIBK) (1986/1987 only)

Cadmium, chromium, lead, and phenols were detected in all four groundwater samples obtained from monitoring wells 36-GW01 through 36-GW04, during the July 1984 sampling round. Table 1-8 provides a summary of groundwater data collected as part of the Confirmation Study at Site 36. Cadmium, chromium, and lead concentrations exceeded either North Carolina Water Quality Standards (NCWQS) or federal maximum contaminant levels (MCLs) in each of the four samples. Total phenols were also detected in each of the four groundwater samples. The maximum phenol concentration, 6 µg/L, was detected within the sample obtained from monitoring well 36-GW02. The VOCs trans-1,2-dichloroethene, methylene chloride, and 1,1,2,2-tetrachloroethane were detected within 36-GW04 (the upgradient location) at concentrations of 2, 7, and 4 µg/L, respectively. No other VOCs were detected during the initial sampling round.

During the second groundwater sampling round, conducted in December 1986, an additional upgradient shallow well (36-GW05) was added to the four existing monitoring wells. Chromium was detected at concentrations which exceeded the MCL (50 µg/L) in four of the five groundwater samples, including samples retained from both upgradient locations. Cadmium, chromium, and lead were detected at maximum concentrations of 4, 142, and 73 µg/L, respectively. Each of these maximum inorganic concentrations were the result of analyses from well 36-GW02. Oil and grease compounds were also detected in four of the five shallow groundwater samples, including both upgradient samples. Oil and grease were not detected in the sample retained from 36-GW03. VOCs were not detected in any of the five samples collected during the second sampling event.

1.4.2.2 Surface Water and Sediment Investigation

Four surface water stations were sampled as part of the Confirmation Study investigation at Site 36. Figure 1-6 depicts the locations of Confirmation Study surface water sampling points on both Brinson Creek and an unnamed tributary to the New River. Two of the four sampling locations, 36-SW/SE01 and 36-SW/SE02, were located on Brinson Creek. Surface water and sediment sampling stations 36-SW/SE03 and 36-SW/SE04 were located on the unnamed tributary to the New River that borders the southern portion of the study area. Each of the four surface water stations were sampled in December 1986. Surface water samples were analyzed for the same parameters as groundwater samples collected during the Confirmation Study.

During the 1986 surface water sampling event, detectable levels of trans-1,2-dichloroethane, lead, and total phenols were recorded at concentrations of 2.5, 39, and 4 µg/L, respectively. These positive contaminant detections were the result of analyses performed on the unnamed tributary sample 36-SW/SE03. Lead was also detected at a concentration of 33.1 µg/L in the upstream sample 36-SW/SE01 from Brinson Creek. Both positive lead detections recorded during the surface water investigation exceeded the state freshwater standard of 25 µg/L.

Four sediment sampling locations, which correspond to the surface water locations, were sampled as part of the December 1986 investigation (refer to Figure 1-6). The sediment samples were analyzed for the following parameters:

- Cadmium
- Chromium
- Hexavalent Chromium
- Oil and Grease
- Lead
- Total Phenols
- Ethylene dibromide (EDB)

Chromium, oil and grease, lead, and total phenols were detected at each of the four sediment sampling locations. In addition, a trace cadmium concentration was detected at location 36-SW/SE04. Table 1-9 presents analytical results from the Confirmation Study sediment investigation.

1.4.2.3 Conclusions and Recommendations of the Confirmation Study

The Confirmation Study identified a number of target contaminants in environmental media throughout Site 36. Metals were the most prevalent contaminant group encountered during both rounds of the groundwater investigation. Concentrations of metals in groundwater generally decreased from one sampling round to the next (1984 to 1986). Analytical results from groundwater, surface water, and sediment samples indicated that the actual disposal area may extend further to the west than was first estimated.

The Confirmation Study recommended that further characterization of groundwater, from both the shallow and deep aquifer, be implemented to complete the RI/FS process. Supplemental surface water and sediment investigations were suggested to determine possible upstream sources of contamination. In addition to groundwater and surface water, a thorough characterization of unsaturated soils within the identified disposal area was recommended to fulfill missing data

requirements. Following the characterization of potentially impacted environmental media, a risk assessment was also recommended to identify if there were any unacceptable risks to human health and the environment.

1.4.3 Additional Investigations

The Confirmation Study at Site 36 focused on the presence of potential contaminants in groundwater, surface water, and sediment. The following additional investigations were conducted to provide supplemental information prior to commencement of RI activities at Site 36.

1.4.3.1 Surface Water and Sediment Investigation

In addition to the data collected during the Confirmation Study, a second round of surface water and sediment data were gathered by Baker in April 1994. This surface water and sediment investigation was conducted during RI activities at OU No. 10 (Site 35). As part of this investigation, surface water and sediment samples were retained from a total of ten sampling stations on Brinson Creek and four stations on the unnamed tributary that borders the southern portion of Site 36. Three of the Brinson Creek sampling stations were situated adjacent to Site 36. The remaining seven Brinson Creek samples were retained from locations adjacent to and upstream of Site 35, the Camp Geiger Area Fuel Farm. Site 35 is also situated along the southern bank of Brinson Creek, approximately 2500 feet upstream of Site 36. Although the surface water and sediment investigation at Site 36 was not performed concurrently with the RI, analytical results from the investigation will be presented within the Nature and Extent of Contamination section of this report (Section 4.0).

1.4.3.2 Aquatic Investigation

An aquatic investigation of Brinson Creek, like the surface water and sediment investigation, was performed in conjunction with RI activities at OU No. 10 (Site 35). During the aquatic investigation of Brinson Creek, fish and benthic macro invertebrate samples were retained from five and nine sampling stations, respectively. Results from this investigation will also be presented in Section 4.0 of this report.

1.4.3.3 RI Scoping Investigation

An RI scoping investigation was conducted at Site 36 during June 1994. Following the identification of 11 abandoned containers (i.e., 5-gallon containers and 55-gallon drums) during the March 1994 initial site survey, a limited drum and soil sampling program was proposed to address potentially impacted media. The objective of the drum sampling program was to collect representative samples from each of the containers and determine appropriate disposal options. During the intervening months between the initial site survey and the drum investigation, however, a majority of the containers were removed from study area by unidentified personnel. Accordingly, only four five-gallon containers were sampled during the investigation. A number of confirmatory soil samples were also obtained to determine if the contents of the various containers had leaked onto the ground surface. Figure 1-7 depicts the locations of four drum areas throughout Site 36 and associated soil borings.

Waste samples were collected from four five-gallon containers, located near the south central portion of the study area. A sample from each container was analyzed for waste compatibility using a field test kit. Based upon test kit results and field observations, the containerized substance was

determined to be a non-reactive flammable liquid. Accordingly, one composite sample representing the contents of the four containers was submitted for analysis of toxicity characteristic leachate procedure (TCLP) contaminants and RCRA waste characteristics (i.e., reactivity, corrosivity, and ignitability). Results of these analyses and visual inspections indicated that the material was a weathered paint product. Lead (2.2 mg/L) and 2-butanone (15 mg/L) were each detected at low levels within the composite sample.

Soil samples were collected at each of the four drum or container areas to determine if possible contaminants had leaked onto the ground surface. A total of 17 soil samples were collected at the four areas using a hand auger. Both a surface (0 to 12 inches) and a subsurface (one to three feet) sample were obtained from eight of the nine soil borings. The 17 samples were analyzed for full Target Compound List (TCL) organic and Target Analyte List (TAL) metals in accordance with Contract Laboratory Program (CLP) methods. Tables 1-10 and 1-11 provide the results of organic and inorganic soil analyses conducted as part of the RI scoping investigation at Site 36, respectively.

Low levels of either styrene, toluene, or 2-butanone were detected in 9 of the 17 soil samples collected at the drum or container areas. Concentrations of these volatile compounds ranged from 1.0 J $\mu\text{g}/\text{kg}$ of styrene to 170 $\mu\text{g}/\text{kg}$ of 2-butanone. The polynuclear aromatic hydrocarbons (PAHs) fluoranthene, chrysene, pyrene, benzo(a)anthracene, benzo(b)fluoranthene, benzo(k)fluoranthene, or benzo(a)pyrene were detected in six of the soil samples. Concentrations of the PAH compounds ranged from 26 J to 540 $\mu\text{g}/\text{kg}$. In addition, at least one of the pesticides 4,4'-DDE, 4,4'-DDD, 4,4'-DDT, aldrin, or dieldrin were detected in 13 of the 17 soil samples. Pesticide concentrations ranged from 4.6 to 420 $\mu\text{g}/\text{kg}$.

The most prevalent contaminants found in soil at Site 36 were PAH compounds, pesticides, and metals. Positive detections of pesticides in soil were typically low and evenly dispersed throughout the four areas. Pesticide concentrations of this magnitude have historically been encountered throughout MCB, Camp Lejeune. Unlike pesticide compounds, the majority of PAHs were found at two of the four drum areas. Metals such as cadmium, chromium, and lead were, in general, found at levels within base-specific background concentrations.

1.4.4 Aerial Photographic Investigation

This section describes the aerial photographs made available through USEPA Region IV. Black-and-white aerial photographs from 1949, 1956, 1960, 1964, and 1970 were made available for examination of surface conditions at Site 36. Visual data from these photographs was used to evaluate potential source areas of contamination. Additional photographs from 1938 and 1943 were used to establish a basis of comparison, prior to development of the Camp Lejeune Military Reservation. The aerial photographs from Site 36 were not annotated or included in any of the USEPA's Environmental Photographic Interpretation Center (EPIC) reporting documents. Figures 1-8 through 1-12 provide reproductions of various aerial photographs and illustrate conditions within the study area over time.

1.4.4.1 Aerial Photograph - October 1949

The 1949 aerial photograph depicts a road that crosses the Seaboard Coastline Railroad right-of-way from the northwest (the rail line has since been abandoned). A number of spur roads lead from this main access route to areas that appear to have been cleared and graded. The Former Disposal Area,

referenced in the IAS report, is located at the terminus of the access road. Figure 1-8 depicts surface conditions at the time of the photograph.

The Camp Geiger STP, located adjacent to the northwestern portion of the study area, was first noted on this aerial photograph. The STP facility has since been expanded and now includes a number of clarifying lagoons and settling ponds.

1.4.4.2 Aerial Photograph - February 1956

From 1949 to 1956 the cleared area expanded to include a majority of the present day study area, as depicted on Figure 1-9. A building and small wharf were constructed on Brinson Creek, along the northern boundary of Site 36. Clearing activities began along the southwestern boundary of the study area and extended eastward along the northern bank of the unnamed tributary. An access road was added to the west of the site, along the rail line, running south toward the air station.

1.4.4.3 Aerial Photograph - December 1960

The access road that bisects Site 36 was extended across Edwards Creek, toward the current location of the Jack's Point Recreation Area. The southeastern boundary of the study area began to revegetate after clearing. Further clearing has taken place in the southwestern and eastern portions of the study area. Since 1956, the western access road has been widened and improved. Figure 1-10 depicts surface conditions at the time of the aerial photograph.

1.4.4.4 Aerial Photograph - February 1964

The north and south central portions of the study area have begun to revegetate, as illustrated on Figure 1-11. Activity continues to the west of the wharf and building along the southern bank of Brinson Creek. The area identified as the Former Disposal Area in the IAS report remains cleared. The northern central portion of the study area has been cleared of trees, but appears to have ground cover (e.g., grass, weeds).

1.4.4.5 Aerial Photograph - October 1970

By 1970, present-day traffic patterns have been established. A covered storage building has been added to the central portion of the study area as noted on Figure 1-12. This covered storage building, the wharf, and the building along Brinson Creek were not present during the 1995 field investigation at Site 36. The central and southern portions of the study area, and the Former Disposal Area have begun to revegetate with trees. Activity continues in the southwestern portion of the site.

1.5 Remedial Investigation Objectives

The purpose of this section is to define the RI objectives intended to characterize past waste disposal activities at Site 36, assess potential impacts to public health and environment, and provide feasible alternatives for consideration during preparation of the ROD. The remedial objectives presented have been identified through review and evaluation of existing background information, assessment of potential risks to public health and environment, and consideration of feasible remediation technologies and alternatives. As part of the remedial investigation at Site 36, soil, groundwater, surface water, sediment, and aquatic investigations were conducted. The information gathered

during these investigations was intended to fill existing data gaps and be employed to generate human health and ecological risk values. Table 1-12 presents both the RI objectives identified for Site 36. In addition, the table provides a general description of the study or investigation efforts that were conducted to obtain the requisite information.

1.6 References

Atlantic Division, Naval Facilities Engineering Command. January 1988. Camp Lejeune Complex Master Plan and Capital Improvements Plan Update. Prepared for the Commanding General, Marine Corps Base, Camp Lejeune, North Carolina.

Baker Environmental, Inc. December 1994. Remedial Investigation/Feasibility Study Work Plan for Operable Unit No. 6 (Sites 36, 43, 44, 54, and 86), Marine Corps Base Camp Lejeune, North Carolina. Final. Prepared for the Department of the Navy, Naval Facilities Engineering Command, Atlantic Division, Norfolk, Virginia.

Baker Environmental, Inc. May 1995. Site Management Plan for Marine Corps Base Camp Lejeune, North Carolina. Draft. Prepared for the Department of the Navy, Naval Facilities Engineering Command, Atlantic Division, Norfolk, Virginia.

Cardinell, A.P., Berg, S.A., and Lloyd, O.B. 1993. Hydrogeologic Framework of U.S. Marine Corps Base at Camp Lejeune, North Carolina: U.S. Geological Survey Water Resources Investigation Report. Report No. 93-4049.

Cowardin, Lewis M., Virginia Carter, Francis C. Golet, and Edward T. LaRoe. December 1979. Classification of Wetlands and Deepwater Habitats of the United States. Performed for U.S. Department of the Interior, Fish and Wildlife Service, Office of Biological Services - FWS/OBS-79/31.

Environmental Science and Engineering, Inc. (ESE) 1990. Site Summary Report. Final. Marine Corps Base, Camp Lejeune, North Carolina. Prepared for the Department of the Navy, Naval Facilities Engineering Command, Atlantic Division, Norfolk, Virginia. ESE Project No. 49-02036.

Environmental Science and Engineering, Inc. (ESE) 1988. Characterization Step Report for Hadnot Point Industrial Area. Marine Corps Base, Camp Lejeune, North Carolina. Prepared for the Department of the Navy, Naval Facilities Engineering Command, Atlantic Division, Norfolk, Virginia. ESE Project No. 49-02036-0150.

Federal Facilities Agreement (FFA) Between United States Environmental Protection Agency, Region IV: the North Carolina Department of Environment, Health and Natural Resources; and United States Department of the Navy for Marine Corps Base, Camp Lejeune and Marine Corps Air Station, New River, North Carolina. December 1989.

Harned, D.A., Lloyd, O.B., Jr., and Treece, M.W., 1989. Assessment of Hydrologic and Hydrogeologic Data at Camp Lejeune Marine Corps Base, North Carolina: U.S. Geological Survey Water Resources Investigation. Report 89-4096, p64.

LeBlond, Richard J., John O. Fussell, and Alvin L. Broswell. February 1994. Inventory of Rare Species, Natural Communities, and Critical Areas of the Camp Lejeune Marine Corps Base, North Carolina. North Carolina Natural Heritage Program, Division of Parks and Recreation, Department of Environment, Health, and Natural Resources, Raleigh, North Carolina.

North Carolina Department of Environment, Health, and Natural Resources (NC DEHNR) May 1992. Interim Guidance for Wetlands Protection. Division of Environment, Water Quality Section.

U.S. Department of the Interior (USDI). March 1982. National Wetland Inventory Map, Camp Lejeune, N.C. Fish and Wildlife Service.

U.S. Marine Corps, MCB, Camp Lejeune (USMC). 1987. Multiple-Use Natural Resources Management Plan. Fish and Wildlife Division, Environmental Management Department, Marine Corps Base, Camp Lejeune, North Carolina.

Water and Air Research, Inc. (WAR) April 1983. Initial Assessment Study of Marine Corps Base Camp Lejeune, North Carolina. Prepared for the Department of the Navy, Naval Energy and Environmental Support Activity, Port Hueneme, California.

SECTION 1.0 TABLES

TABLE 1-1

**GEOLOGIC AND HYDROGEOLOGIC UNITS OF
NORTH CAROLINA'S COASTAL PLAIN
REMEDIAL INVESTIGATION, CTO-0303
MCB, CAMP LEJEUNE, NORTH CAROLINA**

Geologic Units			Hydrogeologic Units
System	Series	Formation	Aquifer and Confining Unit
Quaternary	Holocene/Pleistocene	Undifferentiated	Surficial aquifer
Tertiary	Pliocene	Yorktown Formation ⁽¹⁾	Yorktown confining unit
	Miocene	Eastover Formation ⁽¹⁾	Yorktown Aquifer
		Pungo River Formation ⁽¹⁾	Pungo River confining unit
			Pungo River Aquifer
		Belgrade Formation ⁽²⁾	Castle Hayne confining unit
	Oligocene	River Bend Formation	Castle Hayne Aquifer
	Eocene	Castle Hayne Formation	Beaufort confining unit ⁽³⁾
	Paleocene	Beaufort Formation	Beaufort Aquifer
Cretaceous	Upper Cretaceous	Peedee Formation	Peedee confining unit
			Peedee Aquifer
		Black Creek and Middendorf Formations	Black Creek confining unit
			Black Creek Aquifer
		Cape Fear Formation	Upper Cape Fear confining unit
			Upper Cape Fear Aquifer
	Lower Cape Fear confining unit		
		Lower Cape Fear Aquifer	
Lower Cretaceous ⁽¹⁾	Unnamed deposits ⁽¹⁾	Lower Cretaceous confining unit	
		Lower Cretaceous Aquifer ⁽¹⁾	
Pre-Cretaceous basement rocks		--	--

Note:

- (1) Geologic and hydrologic units probably not present beneath MCB, Camp Lejeune.
- (2) Constitutes part of the surficial aquifer and Castle Hayne confining unit in the study area.
- (3) Estimated to be confined to deposits of Paleocene age in the study area.

Source: Harned et al., 1989.

TABLE 1-2

SUMMARY OF HYDRAULIC PROPERTIES
 UNRELATED SITE INVESTIGATIONS
 REMEDIAL INVESTIGATION, CTO-0303
 MCB, CAMP LEJEUNE, NORTH CAROLINA

Well No.	Hydraulic Conductivity Falling Head Test		Hydraulic Conductivity Rising Head Test		Transmissivity	Storativity
	ft/day	cm/sec	ft/day	cm/sec	gal/day/ft	
MW-30A	1.18	4.16E-04	1.5	5.31E-04	--	--
MW-31A	0.346	1.22E-04	0.269	9.51E-05	--	--
MW-35A	0.119	4.20E-05	0.116	4.06E-05	--	--
MW-32B	6.22	2.20E-03	5.15	1.82E-03	--	--
MW-36B	2.91	1.03E-03	3.2	1.13E-03	--	--
MW-37B	7.06	2.49E-03	6.44	2.27E-03	--	--
GWD-1	6.8	2.40E-03	6.03	2.13E-03	--	--
122MW-3	0.25	8.80E-05	0.015	5.30E-06	--	--
122MW-5	0.47	1.70E-04	0.034	1.20E-05	--	--
122MW-12	0.068	2.40E-05	0.0085	3.00E-06	--	--
MW-13 ⁽¹⁾	0.0554	1.96E-05	0.0032	1.13E-06	--	--
MW-14 ⁽¹⁾	0.188	6.62E-05	7.26E-04	2.56E-07	--	--
MW-3 ⁽²⁾	--	--	0.75	2.60E-04	--	--
MW-4 ⁽²⁾	--	--	0.27	9.50E-05	--	--
MW-11 ⁽²⁾	--	--	0.37	1.30E-04	--	--
MW-21 ⁽²⁾	--	--	0.46	1.60E-04	5.5	0.028
RW-1 ⁽²⁾	--	--	--	--	54	--
MW-18 ⁽²⁾	--	--	--	--	790	0.014

Note: All data compiled from unrelated Baker Investigations within the MCAS, New River operations area.

⁽¹⁾ AS 527

⁽²⁾ Campbell Street Fuel Farm
 A = Upper Surficial Aquifer
 B = Lower Surficial Aquifer

TABLE 1-3

HYDRAULIC PROPERTY ESTIMATES OF THE CASTLE HAYNE AQUIFER
 REMEDIAL INVESTIGATION, CTO-0303
 MCB, CAMP LEJEUNE, NORTH CAROLINA

Hydraulic Properties	USGS Phase I Study ⁽¹⁾	USGS Aquifer Test ⁽²⁾	ESE, Inc. ⁽³⁾	DEHNR Aquifer Test ⁽⁴⁾	RASA Estimate ⁽⁵⁾
Aquifer transmissivity (cubic foot per day per square foot times foot of aquifer thickness)	4,300 to 24,500 average 9,500	1,140 to 1,325	820 to 1,740 average 1,280	900	10,140 to 26,000
Aquifer hydraulic conductivity (foot per day)	14 to 82 average 35	20 to 60	--	18 to 91 average 54	45 to 80 average 65
Aquifer storage coefficient (dimensionless)	--	0.0002 to 0.00022	0.0005 to 0.001 average 0.0008	0.0019	--
Confining-unit vertical hydraulic conductivity (foot per day)	--	0.03 to 0.41	0.0014 to 0.051 average 0.0035	--	--

Note:

- (1) Analysis of specific capacity data from Harned and others (1989).
- (2) Aquifer test at well HP-708.
- (3) Aquifer test at Hadnot Point well HP-462 from Environmental Sciences and Engineering, Inc. (1988).
- (4) Unpublished aquifer test data at well X24s2x, from DEHNR well records (1985).
- (5) Transmissivities based on range of aquifer thickness and average hydraulic conductivity from Winner and Coble (1989).

Source: Cardinell, et al., 1993.

TABLE 1-4

**PROTECTED SPECIES WITHIN MCB, CAMP LEJEUNE
REMEDIAL INVESTIGATION, CTO-0303
MCB, CAMP LEJEUNE, NORTH CAROLINA**

Species	Protected Classification
Animals:	
American alligator (<i>Alligator mississippiensis</i>)	SC
Bachmans sparrow (<i>Aimophila aestivalis</i>)	FCan, SC
Green (Atlantic) turtle (<i>Chelonia m. mydas</i>)	T(f), T(s)
Loggerhead turtle (<i>Caretta caretta</i>)	T(f), T(s)
Peregrine falcon (<i>Falco peregrinus</i>)	E(f), E(s)
Piping plover (<i>Charadrius melodus</i>)	T(f), T(s)
Red-cockaded woodpecker (<i>Picoides borealis</i>)	E(f), E(s)
Southern Hognose Snake (<i>Heterodon simus</i>)	FCan, SR
Diamondback Terrapin (<i>Malaclemys terrapin</i>)	FCan, SC
Carolina Gopher Frog (<i>Rana capito capito</i>)	FCan, SC
Cooper's Hawk (<i>Accipiter cooperii</i>)	SC
Eastern Diamondback Rattlesnake (<i>Crotalus adamanteus</i>)	SR
Eastern Coral Snake (<i>Micrurus fulvius</i>)	SR
Pigmy Rattlesnake (<i>Sistrurus miliarius</i>)	SR
Black Bear (<i>Ursus americanus</i>)	SR
Plants:	
Rough-leaf loosestrife (<i>Lysimachia asperulifolia</i>)	E(f), E(s)
Seabeach Amaranth (<i>Amaranthus pumilus</i>)	T(f), T(s)
Chapman's Sedge (<i>Carex chapmanii</i>)	FCan
Hirst's Witchgrass (<i>Dichanthelium</i> sp.)	FCan
Pondspice (<i>Litsea aestivalis</i>)	FCan
Boykin's Lobelia (<i>Lobelia boykinii</i>)	FCan
Loose Watermilfoil (<i>Myriophyllum laxum</i>)	FCan, T(s)
Awned Meadowbeauty (<i>Rhexia aristosa</i>)	FCan, T(s)
Carolina Goldenrod (<i>Solidago pulchra</i>)	FCan, E(s)
Carolina Asphodel (<i>Tofieldia glabra</i>)	FCan
Venus Flytrap (<i>Dionaea muscipula</i>)	FCan
Flaxleaf Gerardia (<i>Agalinis linifolia</i>)	SR
Pinebarrens Goober Grass (<i>Amphicarpum purshii</i>)	SR
Longleaf Three-awn (<i>Aristida palustris</i>)	SR
Pinebarrens Sandreed (<i>Calamovilfa brevipilis</i>)	E(s)
Warty Sedge (<i>Carex verrucosa</i>)	SR
Smooth Sawgrass (<i>Cladium mariscoides</i>)	SR
Leconte's Flatsedge (<i>Cyperus lecontei</i>)	SR
Erectleaf Witchgrass (<i>Dichanthelium erectifolium</i>)	SR
Horsetail Spikerush (<i>Eleocharis equisetoides</i>)	SR
Sand Spikerush (<i>Eleocharis montevidensis</i>)	SR

TABLE 1-4 (Continued)

PROTECTED SPECIES WITHIN MCB, CAMP LEJEUNE
 REMEDIAL INVESTIGATION, CTO-0303
 MCB, CAMP LEJEUNE, NORTH CAROLINA

Species	Protected Classification
Flaxleaf Seedbox (<i>Ludwigia linifolia</i>)	SR
Torrey's Muhley (<i>Muhlenbergia torreyana</i>)	E(s)
Southeastern Panic Grass (<i>Panicum tenerum</i>)	SR
Spoonflower (<i>Peltandra sagittifolia</i>)	SR
Shadow-witch (<i>Ponthieva racemosa</i>)	SR
West Indies Meadowbeauty (<i>Rhexia cubensis</i>)	SR
Pale Beakrush (<i>Rhynchospora pallida</i>)	SR
Longbeak Baldsedge (<i>Rhynchospora scirpoides</i>)	SR
Tracy's Beakrush (<i>Rhynchospora tracyi</i>)	SR
Canby's Bulrush (<i>Scirpus etuberculatus</i>)	SR
Slender Nutrush (<i>Scleria minor</i>)	SR
Lejeune Goldenrod (<i>Solidago</i> sp.)	SR
Dwarf Bladderwort (<i>Utricularia olivacea</i>)	T(s)
Elliott's Yellow-eyed Grass (<i>Xyris elliottii</i>)	SR
Carolina Dropseed (<i>Sporobolus</i> sp.)	T(s)

Legend:

- E(f) = Federal Endangered
- T(f) = Federal Threatened
- Fcan = Candidate for Federal Listing
- E(s) = State Endangered
- T(s) = State Threatened
- SC = State Special Concern
- SR = State Rare

Source: LeBlond, 1994

TABLE 1-5

**LAND UTILIZATION WITHIN DEVELOPED AREAS OF MCB, CAMP LEJEUNE
REMEDIAL INVESTIGATION, CTO-0303
MCB, CAMP LEJEUNE, NORTH CAROLINA**

Geographic Area	Operation	Training (Instruc.)	Maintenance	Supply/ Storage	Medical	Admin- istration	Family Housing	Troop Housing	CM	CO	Recreation	Utility	Total
Hadnot Point	31 (2.9)	15 (1.4)	154 (14.3)	157 (14.4)	10 (0.9)	122 (11.3)	22 (2.0)	196 (18.1)	115 (10.7)	36 (3.3)	182 (16.9)	40 (3.7)	1,080 (100)
Paradise Point	1 (0)		3 (0.4)	1 (0)			343 (34)	19 (1.9)	31 (3.1)		610 (60.4)	2 (0.2)	1,010 (100)
Berkeley Manor/ Watkins							406 (80)		41 (8.1)	1 (0.2)	57 (11.2)	2 (0.5)	507 (100)
Midway Park		1 (0.4)		2 (0.7)		2 (0.7)	248 (92.2)		8 (3.0)	3 (1.1)	4 (1.5)	1 (0.4)	269 (100)
Tarawa Terrace I and II			3 (0.5)			1 (0.3)	428 (77.4)		55 (9.9)	11 (2.0)	47 (8.5)	8 (1.4)	553 (100)
Knox Trailer							57 (100)						
French Creek	8 (1.4)	1 (0.2)	74 (12.7)	266 (45.6)	3 (0.5)	7 (1.2)		122 (20.9)	22 (3.8)	6 (1.0)	74 (12.7)		583 (100)
Courthouse Bay		73 (28.6)	28 (10.9)	14 (5.5)		12 (4.7)	12 (4.7)	43 (16.9)	15 (5.9)	4 (1.6)	43 (16.9)	11 (4.3)	255 (100)
Onslow Beach	6 (9.8)	1 (1.6)	3 (4.8)	2 (3.2)	1 (1.6)	2 (3.2)		2 (3.2)	12 (19.3)		25 (40.3)	8 (13.0)	62 (100)
Rifle Range		1 (1.3)	1 (1.3)	7 (8.8)	1 (1.3)	5 (6.3)	7 (8.8)	30 (37.5)	5 (6.3)	1 (1.3)	9 (11.3)	13 (16.3)	80 (100)
Camp Geiger	4 (1.9)	15 (6.9)	19 (8.8)	50 (23.1)		23 (10.6)		54 (25.0)	27 (12.5)	2 (1.0)	16 (7.4)	6 (2.8)	216 (100)
Montford Point	6 (2.6)	48 (20.5)	2 (0.9)	4 (1.7)	2 (0.9)	9 (3.9)		82 (35.2)	20 (8.6)	1 (0.4)	49 (21.0)	10 (4.3)	233 (100)
Base-Wide Misc.	1 (0.8)			87 (68.0)		3 (2.3)			19 (14.8)			18 (14.1)	128 (100)
TOTAL	57 (1.)	155 (3.1)	287 (5.7)	590 (11.7)	17 (0.38)	186 (3.7)	1,523 (30.2)	548 (10.8)	370 (7.4)	65 (1.3)	1,116 (22.2)	119 (2.4)	5,033 (100)

Notes:

Numbers without parentheses represent total acres.
Numbers within parentheses represent percentage of total acres.
Source: Master Plan, 1988

TABLE 1-6

CLIMATIC DATA SUMMARY
 MARINE CORPS AIR STATION, NEW RIVER
 REMEDIAL INVESTIGATION, CTO-0303
 MCB, CAMP LEJEUNE, NORTH CAROLINA

	Precipitation (Inches)			Relative Humidity (Percent)	Temperature (Fahrenheit)			Mean Number of Days With				
	Maximum	Minimum	Average		Maximum	Minimum	Average	Precipitation		Temperature		
								>=0.01"	>=0.5"	>=90F	>=75F	<=32F
January	7.5	1.4	4.0	79	54	34	44	11	2	0	1	16
February	9.1	.9	3.9	78	57	36	47	10	3	0	2	11
March	8	.8	3.9	80	64	43	54	10	3	*	5	5
April	8.8	.5	3.1	79	73	51	62	8	2	1	13	*
May	8.4	.6	4.0	83	80	60	70	10	3	2	25	0
June	11.8	2.2	5.2	84	86	67	77	10	4	7	29	0
July	14.3	4.0	7.7	86	89	72	80	14	5	13	31	0
August	12.6	1.7	6.2	89	88	71	80	12	4	11	31	0
September	12.8	.8	4.6	89	83	66	75	9	3	4	27	0
October	8.9	.6	2.9	86	75	54	65	7	2	*	17	*
November	6.7	.6	3.2	83	67	45	56	8	2	0	7	3
December	6.6	.4	3.7	81	58	37	48	9	2	0	2	12
Annual	65.9	38.2	52.4	83	73	53	63	118	35	39	189	48

Note:

* = Mean no. of days less than 0.5 days

Source: Naval Oceanography Command Detachment, Asheville, North Carolina. Measurements obtained from January 1955 to December 1990.

TABLE 1-7

SUMMARY OF MONITORING WELL CONSTRUCTION DETAILS
 CONFIRMATION STUDY
 SITE 36, CAMP GEIGER AREA DUMP
 REMEDIAL INVESTIGATION, CTO-0303
 MCB, CAMP LEJEUNE, NORTH CAROLINA

Well No.	Date Installed	Top of PVC Casing Elevation (feet, above msl) ⁽¹⁾	Ground Surface Elevation (feet, above msl)	Boring Depth (feet, below ground surface) ⁽²⁾	Well Depth (feet, below ground surface) ⁽²⁾	Screen Interval Depth (feet, below ground surface)	Sand Pack Interval Depth (feet, below ground surface)	Bentonite Interval Depth (feet, below ground surface)
36-GW01	7/84	8.93	6.4	≈24	≈23.5	≈8.5-23.5	NA	NA
36-GW02	7/84	8.80	6.4	≈23	≈22.5	≈7.5-22.5	NA	NA
36-GW03	7/84	8.70	6.5	NA	NA	NA	NA	NA
36-GW04	7/84	14.24	12.1	≈21	≈20	≈5-20	NA	NA
36-GW05	12/86	16.50	14.4	≈26	≈25	≈10-25	NA	NA

Notes:

⁽¹⁾ msl = mean sea level

⁽²⁾ Measurements were taken from geologic cross section of Site 36.

NA - Information Not Available

Horizontal positions are referenced to N.C. State Plane Coordinate System (NAD 27) CF = 0.9999216 from USMC Monument Toney.

Vertical datum NGVD 29.

TABLE 1-8

DETECTED TARGET CONTAMINANTS IN GROUNDWATER
 CONFIRMATION STUDY
 SITE 36, CAMP GEIGER AREA DUMP
 REMEDIAL INVESTIGATION, CTO-0303
 MCB, CAMP LEJEUNE, NORTH CAROLINA

Sample Number: Date Sampled:	Standards		36-GW01 7/31/84	36-GW01 7/31/84	36-GW01 12/9/86	36-GW02 7/31/84	36-GW02 7/31/84	36-GW02 12/9/86	36-GW03 7/31/84	36-GW03 7/31/84	36-GW03 12/9/86
	MCL ⁽¹⁾	NCWQS ⁽²⁾									
Parameter: Units (µg/L)	MCL ⁽¹⁾	NCWQS ⁽²⁾	36-GW01 7/31/84	36-GW01 7/31/84	36-GW01 12/9/86	36-GW02 7/31/84	36-GW02 7/31/84	36-GW02 12/9/86	36-GW03 7/31/84	36-GW03 7/31/84	36-GW03 12/9/86
trans-1,2-Dichloroethene	100	70	ND	ND	ND	ND	ND	ND	ND	ND	ND
Methylene Chloride	5	5	ND	ND	ND	ND	ND	ND	ND	ND	ND
1,1,2,2-Tetrachloroethane	--	--	ND	ND	ND	ND	ND	ND	ND	ND	ND
Cadmium	5	5	12	8	3	14	19	4	7	NA	ND
Chromium	100	50	480	510	130	420	680	142	280	NA	12
Lead	15 ⁽³⁾	15	324	265	45	249	347	73	104	NA	29
Phenols	--	--	3	2	4	2	6	7	3	3	3
Oil & Grease	--	--	ND	ND	2,000	ND	ND	2,000	ND	ND	ND

TABLE 1-8 (Continued)

DETECTED TARGET CONTAMINANTS IN GROUNDWATER
 CONFIRMATION STUDY
 SITE 36, CAMP GEIGER AREA DUMP
 REMEDIAL INVESTIGATION, CTO-0303
 MCB, CAMP LEJEUNE, NORTH CAROLINA

Sample Number: Date Sampled:	Standards		36-GW04 7/31/84	36-GW04 7/31/84	36-GW04 12/9/86	36-GW05 12/9/86	36-GW05 3/5/87
	MCL ⁽¹⁾	NCWQS ⁽²⁾					
Parameter: Units (µg/L)							
trans-1,2-Dichloroethene	100	70	2	1.2	ND	ND	ND
Methylene Chloride	5	5	ND	7	ND	ND	ND
1,1,2,2-Tetrachloroethane	--	--	4	3	ND	ND	ND
Cadmium	5	5	9	NA	ND	ND	ND
Chromium	100	50	510	NA	103	18.2	51
Lead	15 ⁽³⁾	15	217	NA	ND	ND	ND
Phenols	--	--	2	1	ND	ND	ND
Oil & Grease	--	--	ND	ND	2,000	1,000	1,000

Notes:

Concentrations reported in micrograms per liter (µg/L); or parts per billion (ppb).
 ND = Not detected

- (1) Federal maximum contaminant levels (MCLs) established under the Safe Drinking Water Act of 1986.
- (2) NCWQS - North Carolina administrative code, Title 15A, NC DEHNR, Subchapter 2L, Section .0202 - Water Quality Standards (WQS) for groundwater.
- (3) Federal action level established under the Safe Drinking Water Act of 1986.

Source: ESE, Site Summary Report, Final. September, 1990.

TABLE 1-9

**DETECTED TARGET CONTAMINANTS IN SEDIMENT
CONFIRMATION STUDY
SITE 36, CAMP GEIGER AREA DUMP
REMEDIAL INVESTIGATION, CTO-0303
MCB, CAMP LEJEUNE, NORTH CAROLINA**

Sample Number: Date Sampled:	NOAA ⁽¹⁾		36-SE01 12/9/86	36-SE02 12/10/86	36-SE03 12/10/86	36-SE04 12/10/86
	ER-L ⁽²⁾	ER-M ⁽³⁾				
Parameter: Units (mg/kg)						
Cadmium	5	9	ND	ND	ND	0.722
Chromium	80	145	8.49	14.2	5.29	5.44
Lead	35	110	77.5	42.5	15.3	10.7
Oil & Grease	--	--	1,480	2,410	1,200	185
Phenols	--	--	2,030	1,950	1,080	464

Notes:

Concentrations reported in micrograms per liter ($\mu\text{g/L}$); or parts per billion (ppb).

ND = Not detected

⁽¹⁾ NOAA - National Oceanic and Atmospheric Administration Sediment Screening Values (USEPA Region IV, 1992).

⁽²⁾ ER-L - Effects range - low if contaminant concentrations fall below the ER-L, adverse aquatic effects are considered unlikely.

⁽³⁾ ER-M - Effects range - if the value falls between ER-L and ER-M, adverse aquatic effects are considered possible.

Source: ESE, Site Summary Report, Final. September, 1990.

TABLE 1-10

**DETECTED ORGANIC COMPOUNDS IN SOIL
RI SCOPING INVESTIGATION
SITE 36, CAMP GEIGER AREA DUMP
REMEDIAL INVESTIGATION, CTO-0303
MCB, CAMP LEJEUNE, NORTH CAROLINA**

Contaminant	Sample Identification Number/Sample Depth (feet)					
	36-A-SB01-00 (0-12")	36-A-SB01-02 (2-3')	36-A-SB02-00 (0-12")	36-A-SB02-02 (2-3')	36-A-SB03-00 (0-12")	36-A-SB03-02 (2-3')
Volatiles (µg/kg)						
Methylene Chloride	9.0 J	12	9.0 J	11	7.0 J	9.0 J
Styrene	2.0 J	ND	1.0 J	ND	ND	ND
Toluene	ND	ND	ND	ND	ND	ND
2-Butanone	ND	ND	ND	ND	ND	ND
Semivolatiles (µg/kg)						
Di-n-butylphthalate	100 J	230 J	180 J	220 J	61 J	200 J
Phenanthrene	ND	ND	ND	ND	ND	ND
Fluoranthene	ND	ND	ND	ND	ND	ND
Pyrene	ND	ND	ND	ND	ND	ND
Chrysene	ND	ND	ND	ND	ND	ND
Benzo(a)anthracene	ND	ND	ND	ND	ND	ND
Benzo(b)fluoranthene	ND	ND	ND	ND	ND	ND
Benzo(k)fluoranthene	ND	ND	ND	ND	ND	ND
Benzo(a)pyrene	ND	ND	ND	ND	ND	ND
Pesticides/PCBs (µg/kg)						
4,4'-DDE	4.6	ND	10	ND	13	ND
4,4'-DDT	6.0	ND	13	ND	23	ND
4,4'-DDD	ND	ND	ND	ND	ND	ND
Aldrin	ND	ND	ND	ND	ND	ND

TABLE 1-10 (Continued)

DETECTED ORGANIC COMPOUNDS IN SOIL
 RI SCOPING INVESTIGATION
 SITE 36, CAMP GEIGER AREA DUMP
 REMEDIAL INVESTIGATION, CTO-0303
 MCB, CAMP LEJEUNE, NORTH CAROLINA

Contaminant	Sample Identification Number/Sample Depth (feet)					
	36-B-SB01-00 (0-12")	36-B-SB01-02 (2-3')	36-B-SB02-00 (0-12")	36-B-SB02-02 (2-3')	36-C-SB01-02 (0-12")	36-C-SB01-02 (2-3')
Volatiles (µg/kg)						
Methylene Chloride	9.0 J	3.0 J	3.0 J	3.0 J	3.0 J	7.0 J
Styrene	ND	ND	ND	ND	ND	ND
Toluene	2.0 J	4.0 J	7.0 J	6.0 J	3.0 J	ND
2-Butanone	ND	ND	ND	ND	ND	ND
Semivolatiles (µg/kg)						
Di-n-butylphthalate	58 J	200 J	190 J	82 J	56 J	ND
Phenanthrene	ND	57 J	ND	83 J	ND	ND
Fluoranthene	ND	45 J	ND	97 J	52 J	ND
Pyrene	ND	40 J	ND	86 J	48 J	ND
Chrysene	ND	35 J	ND	53 J	ND	ND
Benzo(a)anthracene	ND	ND	ND	45 J	ND	ND
Benzo(b)fluoranthene	ND	ND	ND	46 J	31 J	ND
Benzo(k)fluoranthene	ND	ND	ND	26 J	ND	ND
Benzo(a)pyrene	ND	ND	ND	32 J	ND	ND
Pesticides/PCBs (µg/kg)						
4,4'-DDE	49	69	130	75	NA	78
4,4'-DDT	15	23	68	23	NA	61
4,4'-DDD	6.9	9.2	9.5	130	NA	100
Aldrin	ND	ND	ND	19	NA	ND

TABLE 1-10 (Continued)

**DETECTED ORGANIC COMPOUNDS IN SOIL
RI SCOPING INVESTIGATION
SITE 36, CAMP GEIGER AREA DUMP
REMEDIAL INVESTIGATION, CTO-0303
MCB, CAMP LEJEUNE, NORTH CAROLINA**

Contaminant	Sample Identification Number/Sample Depth (feet)				
	36-C-SB02-00 (0-12")	36-C-SB02-02 (2-3')	36-D-SB01-00 (0-12")	36-D-SB02-00 (0-12")	36-D-SB02-01 (2-3')
Volatiles (µg/kg)					
Methylene Chloride	ND	ND	3.0 J	4.0 J	7.0 J
Styrene	ND	ND	ND	ND	ND
Toluene	3.0 J	ND	3.0 J	ND	ND
2-Butanone	ND	170	ND	ND	ND
Semivolatiles (µg/kg)					
Di-n-butylphthalate	210	ND	ND	270 J	150 J
Phenanthrene	ND	ND	62 J	56 J	170 J
Fluoranthene	ND	ND	330 J	120 J	210 J
Pyrene	ND	ND	540	110 J	190 J
Chrysene	ND	ND	190 J	64 J	120 J
Benzo(a)anthracene	ND	ND	130 J	ND	110 J
Benzo(b)fluoranthene	ND	ND	170 J	55 J	100 J
Benzo(k)fluoranthene	ND	ND	110 J	30 J	63 J
Benzo(a)pyrene	ND	ND	73 J	ND	73 J
Pesticides/PCBs (µg/kg)					
4,4'-DDE	360	86	310	110	64
4,4'-DDT	420	29	33	30	6.5
4,4'-DDD	210	43	13	14	270
Aldrin	ND	ND	ND	ND	ND

Notes:

Concentrations reported in micrograms per kilogram (µg/kg); or parts per billion (ppb).

ND = Not Detected
J = Value Estimated

Source: Baker Environmental, Inc. July, 1994.

TABLE 1-11

**DETECTED INORGANICS IN SOIL
RI SCOPING INVESTIGATION
SITE 36, CAMP GEIGER AREA DUMP
REMEDIAL INVESTIGATION, CTO-0303
MCB, CAMP LEJEUNE, NORTH CAROLINA**

Contaminant	Sample Identification Number/Sample Depth (feet)					
	36-A-SB01-00 (0-12")	36-A-SB01-02 (2-3')	36-A-SB02-00 (0-12")	36-A-SB02-02 (2-3')	36-A-SB03-00 (0-12")	36-A-SB03-02 (2-3')
Metals (mg/kg)						
Aluminum	5,260	13,900	4,550	12,100	5,560	2,440
Antimony	ND	ND	ND	ND	ND	ND
Arsenic	0.85 B	0.51	0.5	ND	ND	0.46
Barium	8.7	18.6	7.0	15.5	10.7	4.4
Cadmium	ND	ND	ND	ND	ND	ND
Calcium	974	81.6	144	71.7	472	52
Chromium	11.7	14.9	4.9	12.2	7.2	3.7
Cobalt	1.0	0.52	ND	0.45	ND	ND
Copper	2.0	1.2	ND	ND	1.3	ND
Iron	4,210	4,490	2,310	4,120	3,980	1,310
Lead	43.5	22.7	7.8	7.1	10.8	4.1
Magnesium	278	483	150	430	233	85.8
Managanese	4.5	8.0	4.6	8.7	8.3	2.7
Mercury	ND	ND	ND	ND	ND	ND
Nickel	ND	2.7B	ND	2.4	ND	ND
Potassium	293	481	ND	283	3,160	ND
Selenium	0.75	ND	ND	ND	ND	ND
Silver	ND	ND	ND	ND	ND	ND
Sodium	21.9	32.7	19.7	40.6	30.5	15.8
Vanadium	11.2	21.4	7.9	18.7	12.6	6.1
Zinc	10.1	5.4	4.8	5.2	7.5	2.6

TABLE 1-11 (Continued)

**DETECTED INORGANICS IN SOIL
RI SCOPING INVESTIGATION
SITE 36, CAMP GEIGER AREA DUMP
REMEDIAL INVESTIGATION, CTO-0303
MCB, CAMP LEJEUNE, NORTH CAROLINA**

Contaminant	Sample Identification Number/Sample Depth (feet)					
	36-B-SB01-00 (0-12")	36-B-SB01-02 (2-3')	36-B-SB02-00 (0-12")	36-B-SB02-02 (2-3')	36-C-SB01-02 (0-12")	36-C-SB01-02 (2-3')
Metals (mg/kg)						
Aluminum	4,750	4,130	2,300	3,900	3,680	6,350
Antimony	5.3	6.5	5,470	8.1	8.8	6.5
Arsenic	1.2	1.9	2.3	2.8	3.0	0.91
Barium	33.4	31.2	43.5	29.1	35.9	38.4
Cadmium	ND	ND	0.75	ND	ND	ND
Calcium	860	938	740	710	1,070	2,570
Chromium	7.7	7.2	5.2	6.8	8.6	10.6
Cobalt	1.2	0.83	ND	0.56	ND	1.0
Copper	23.2	19	114	19.2	63.5	27.1
Iron	4,770	6,880	10,600	3,230	5,990	5,570
Lead	92.3	62.5	194,000	82	115	66.9
Magnesium	211	200	188	204	240	574
Managanese	130	77.6	63.9	49.2	63	55.6
Mercury	0.66	1.5	1.5	1.1	2.6	1.4
Nickel	1.9	3.5	ND	3.0	5.9	ND
Potassium	ND	ND	ND	297	ND	670
Selenium	ND	ND	ND	ND	ND	ND
Silver	0.53	ND	8.5	0.89	0.61	0.94
Sodium	139	159	65.8	159	238	360
Vanadium	8.3	8.1	5.4	7.4	9.6	11.2
Zinc	193	183	218	217	196	155

TABLE 1-11 (Continued)

DETECTED INORGANICS IN SOIL
 RI SCOPING INVESTIGATION
 SITE 36, CAMP GEIGER AREA DUMP
 REMEDIAL INVESTIGATION, CTO-0303
 MCB, CAMP LEJEUNE, NORTH CAROLINA

Contaminant	Sample Identification Number/Sample Depth (feet)				
	36-C-SB02-00 (0-12")	36-C-SB02-02 (2-3')	36-D-SB01-00 (0-12")	36-D-SB02-00 (0-12")	36-D-SB02-01 (2-3')
Metals (mg/kg)					
Aluminum	3,820	6,810	6,170	4,600	8,030
Antimony	6.4	6.9	ND	4.6	4.6
Arsenic	2.1	ND	2.1	3.2	1.7
Barium	44.9	49.1	25.6	57.9	35.5
Cadmium	5.9	ND	ND	ND	ND
Calcium	931	4,360	1,950	3,750	7,560
Chromium	8.2	8.1	11.1	12	17.3
Cobalt	0.99	0.86	0.67	1.2	1.2
Copper	99.1	13.3	14.7	47.5	16.8
Iron	6,300	3,580	5,420	7,430	5,730
Lead	128	31.3	82	203	95.4
Magnesium	287	825	573	435	519
Managanese	272	42.5	31	141	28.7
Mercury	1.9	1.3	0.50	1.7	0.24
Nickel	4.4	3.5	3.4	3.2	ND
Potassium	ND	ND	ND	ND	468
Selenium	ND	ND	ND	ND	ND
Silver	ND	0.89	ND	0.93	0.66
Sodium	287	680	867	436	208
Vanadium	9.4	11.7	15.5	14.1	14.1
Zinc	864	187	104	270	97.6

Notes:

Concentrations reported in milligrams per kilogram (mg/kg); or parts per million (ppm).

ND = Not Detected

Source: Baker Environmental, Inc. July, 1994.

TABLE 1-12

REMEDIAL INVESTIGATION OBJECTIVES
 SITE 36, CAMP GEIGER AREA DUMP
 REMEDIAL INVESTIGATION, CTO-0303
 MCB, CAMP LEJEUNE, NORTH CAROLINA

Medium or Area of Concern	RI/FS Objective	Criteria for Meeting Objective	Proposed Investigation/Study
1. Soil	1a. Assess the extent of soil contamination within the formerly cleared area, open field area, and former dump area.	Characterize contaminant levels in surface and subsurface soils within the formerly cleared area, open field area, and former dump area.	Soil Investigation
	1b. Assess human health and ecological risks associated with exposure to surface soils at Site 36.	Characterize contaminant levels in surface soils at Site 36.	Soil Investigation Risk Assessment
	1c. Determine the physical and chemical nature of buried debris or waste.	Characterize the physical and chemical nature of the buried debris or waste.	Exploratory Test Pit Investigation
2. Groundwater	2a. Determine whether organic or inorganic contamination from soils is migrating to groundwater.	Characterize groundwater quality.	Groundwater Investigation
	2b. Assess health risks posed by potential future usage of the shallow and deep groundwater.	Evaluate groundwater quality and compare to ARARs and health-based action levels.	Groundwater Investigation Risk Assessment
	2c. Assess the extent of shallow and deep groundwater contamination.	Determine the horizontal extent of shallow groundwater contamination; determine the horizontal and vertical extent of deep groundwater contamination.	Groundwater Investigation
	2d. Define hydrogeologic characteristics for fate and transport evaluation and remedial technology evaluation, if required.	Estimate hydrogeologic characteristics of the shallow and deep aquifers (flow direction, transmissivity, permeability, etc.).	Groundwater Investigation

TABLE 1-12 (Continued)

REMEDIAL INVESTIGATION OBJECTIVES
 SITE 36, CAMP GEIGER AREA DUMP
 REMEDIAL INVESTIGATION, CTO-0303
 MCB, CAMP LEJEUNE, NORTH CAROLINA

Medium or Area of Concern	RI/FS Objective	Criteria for Meeting Objective	Proposed Investigation/Study
3. Surface Water and Sediment	3a. Assess the presence or absence of surface water and sediment contamination in Brinson Creek and the unnamed tributary.	Determine if surface water and sediment in Brinson Creek and the unnamed tributary are contaminated.	Surface Water and Sediment Investigation
	3b. Assess human health and ecological risks associated with exposure to surface water and sediments in Brinson Creek and the unnamed tributary.	Characterize nature and extent of contamination in both surface water and sediments.	Surface Water and Sediment Investigation Risk Assessment
	3c. Assess potential ecological impacts posed by contaminated surface water sediments in the unnamed tributary and Brinson Creek.	Qualitatively evaluate stress to benthic and fish communities.	Surface Water and Sediment Investigation Ecological Risk Assessment
4. Waste	4a. Determine the nature of drum/container waste material.	Characterize the nature of the waste.	Drum/Container Sampling Investigation
	4b. Evaluate disposal options for wastes.	Evaluate chemical data for comparison with disposal criteria.	Drum/Container Sampling Investigation

SECTION 1.0 FIGURES

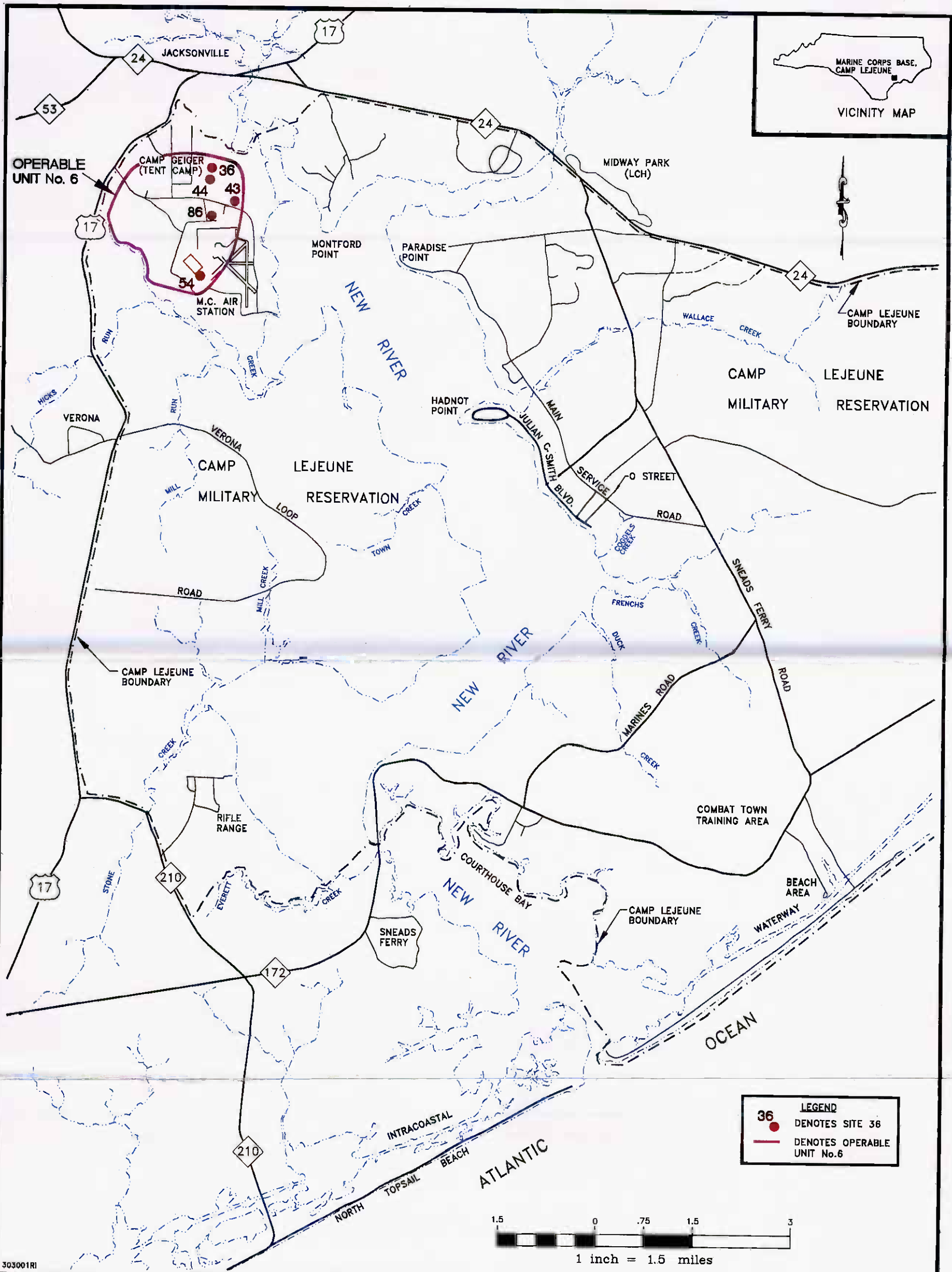


FIGURE 1-1
 OPERABLE UNIT No. 6 - SITES 36, 43, 44, 54, AND 86
 REMEDIAL INVESTIGATION, CTO-0303

MARINE CORPS BASE, CAMP LEJEUNE
 NORTH CAROLINA

01710 VBIY

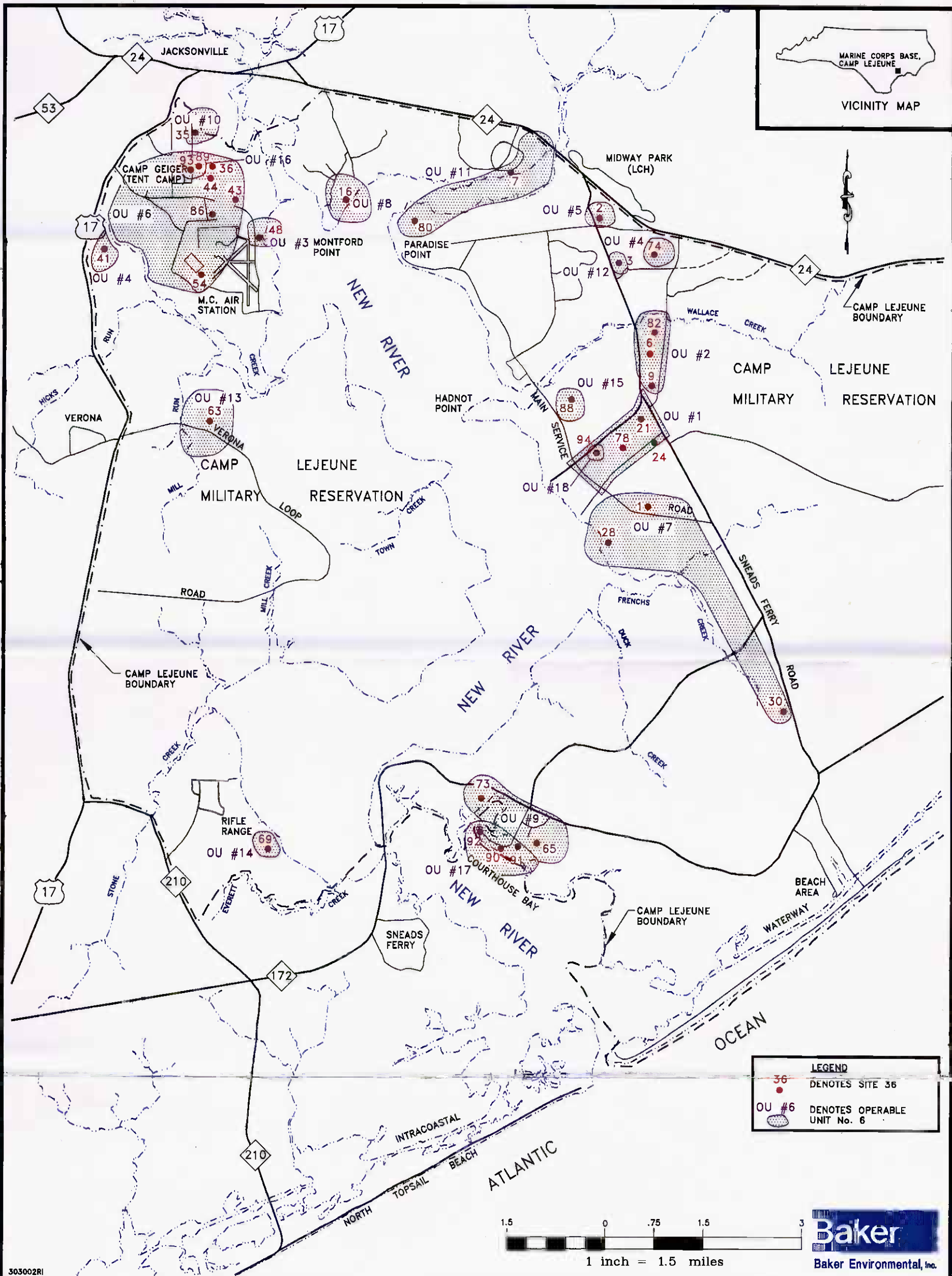
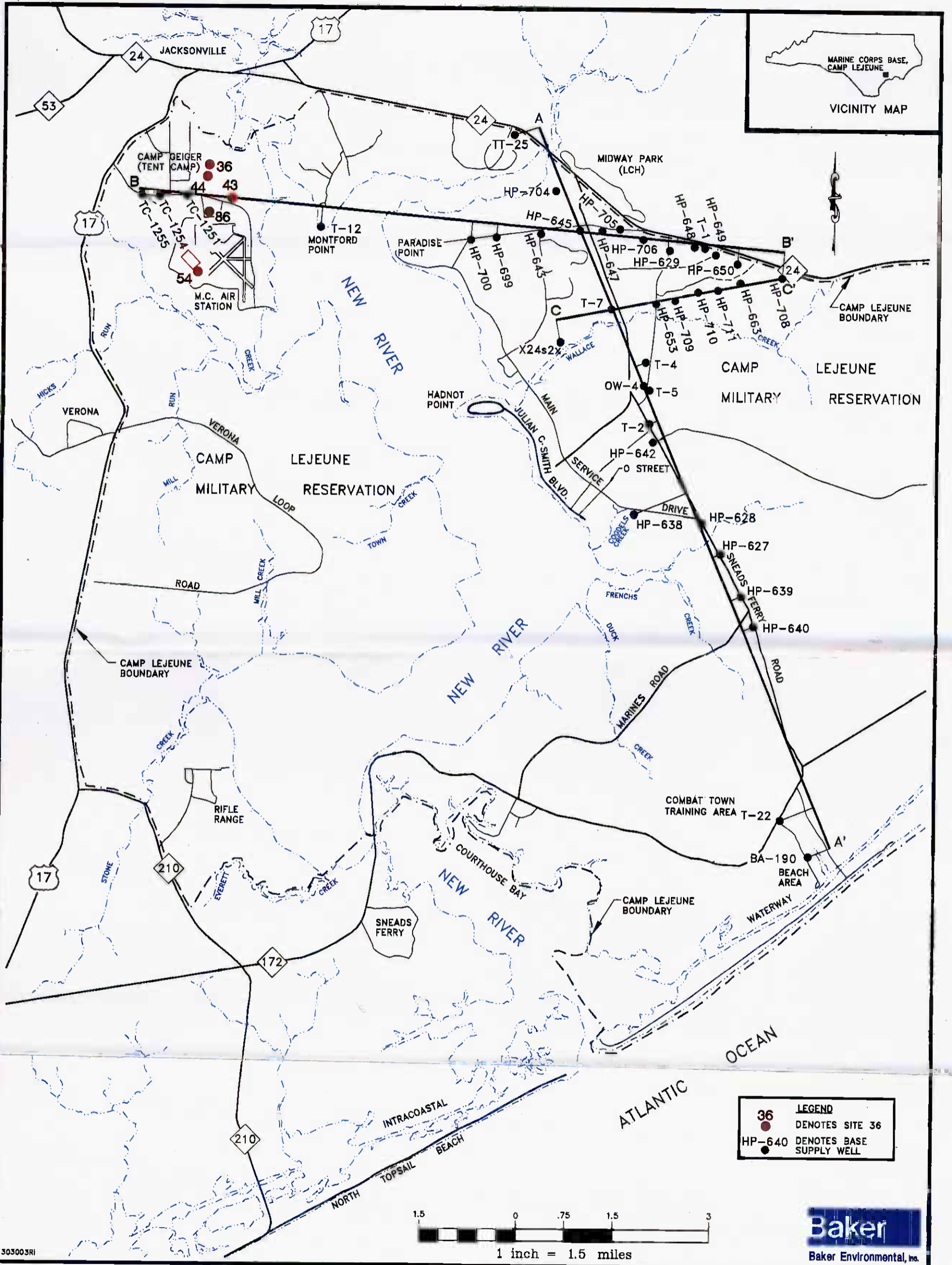


FIGURE 1-2
OPERABLE UNIT AND SITE LOCATIONS
REMEDIAL INVESTIGATION, CTO-0303

MARINE CORPS BASE, CAMP LEJEUNE
NORTH CAROLINA



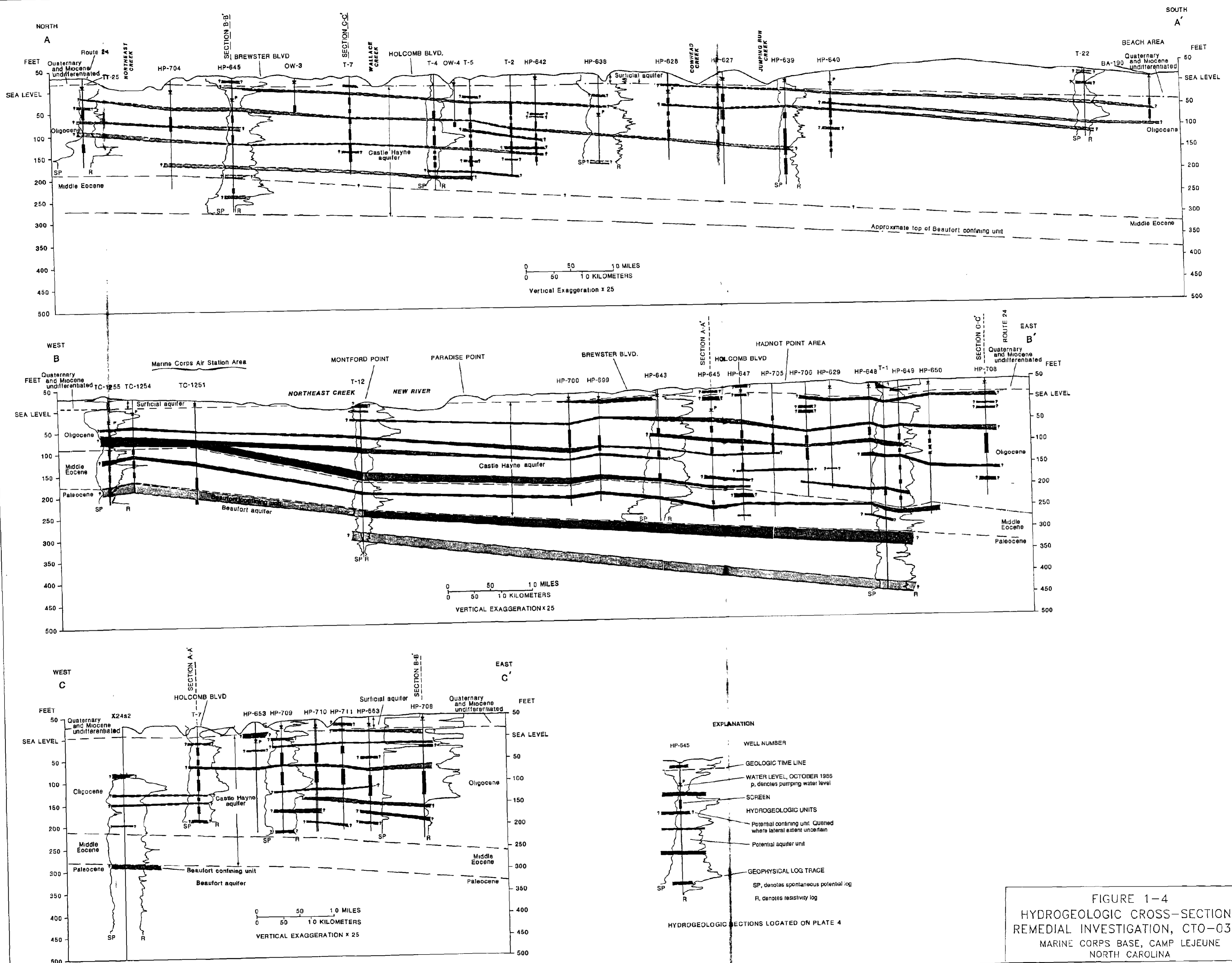
303003RI

SOURCE: DEPT. OF INTERIOR,
WATER-RESOURCES INVESTIGATIONS
REPORT, 89-4096, PLATE 4

FIGURE 1-3
LOCATIONS OF HYDROGEOLOGIC CROSS-SECTIONS
REMEDIAL INVESTIGATION, CTO-0303

MARINE CORPS BASE, CAMP LEJEUNE
NORTH CAROLINA

Baker
Baker Environmental, Inc.



EXPLANATION

- HP-645 WELL NUMBER
- GEOLOGIC TIME LINE
- WATER LEVEL, OCTOBER 1985
p, denotes pumping water level
- SCREEN
- HYDROGEOLOGIC UNITS
- Potential confining unit. Quenched
where lateral extent uncertain
- Potential aquifer unit
- GEOPHYSICAL LOG TRACE
- SP, denotes spontaneous potential log
R, denotes resistivity log

HYDROGEOLOGIC SECTIONS LOCATED ON PLATE 4

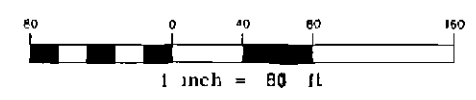
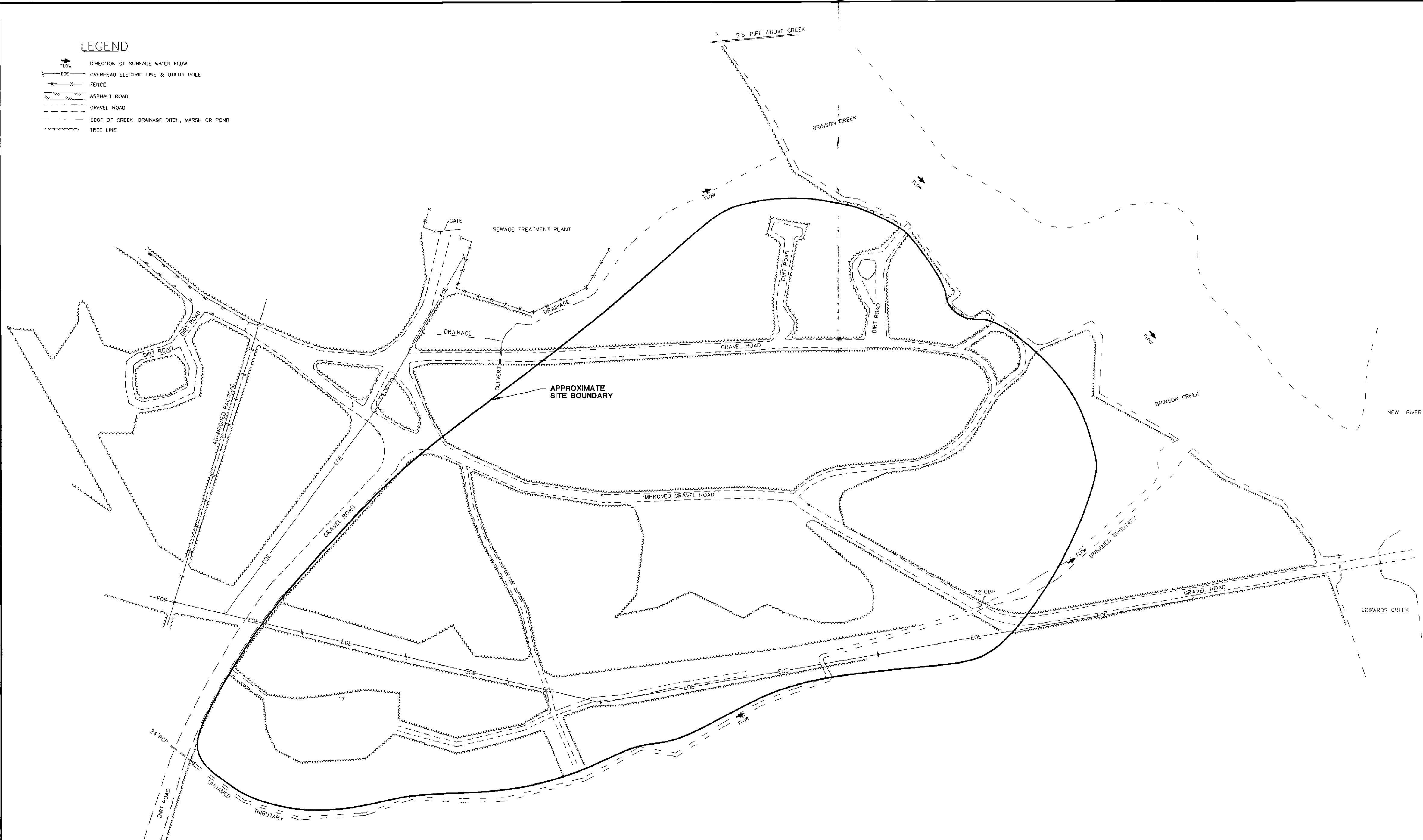
FIGURE 1-4
 HYDROGEOLOGIC CROSS-SECTIONS
 REMEDIAL INVESTIGATION, CTO-0303
 MARINE CORPS BASE, CAMP LEJEUNE
 NORTH CAROLINA

HYDROGEOLOGIC SECTIONS A-A', B-B', AND C-C' AT CAMP LEJEUNE, NORTH CAROLINA

017104 B2X

LEGEND

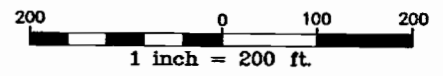
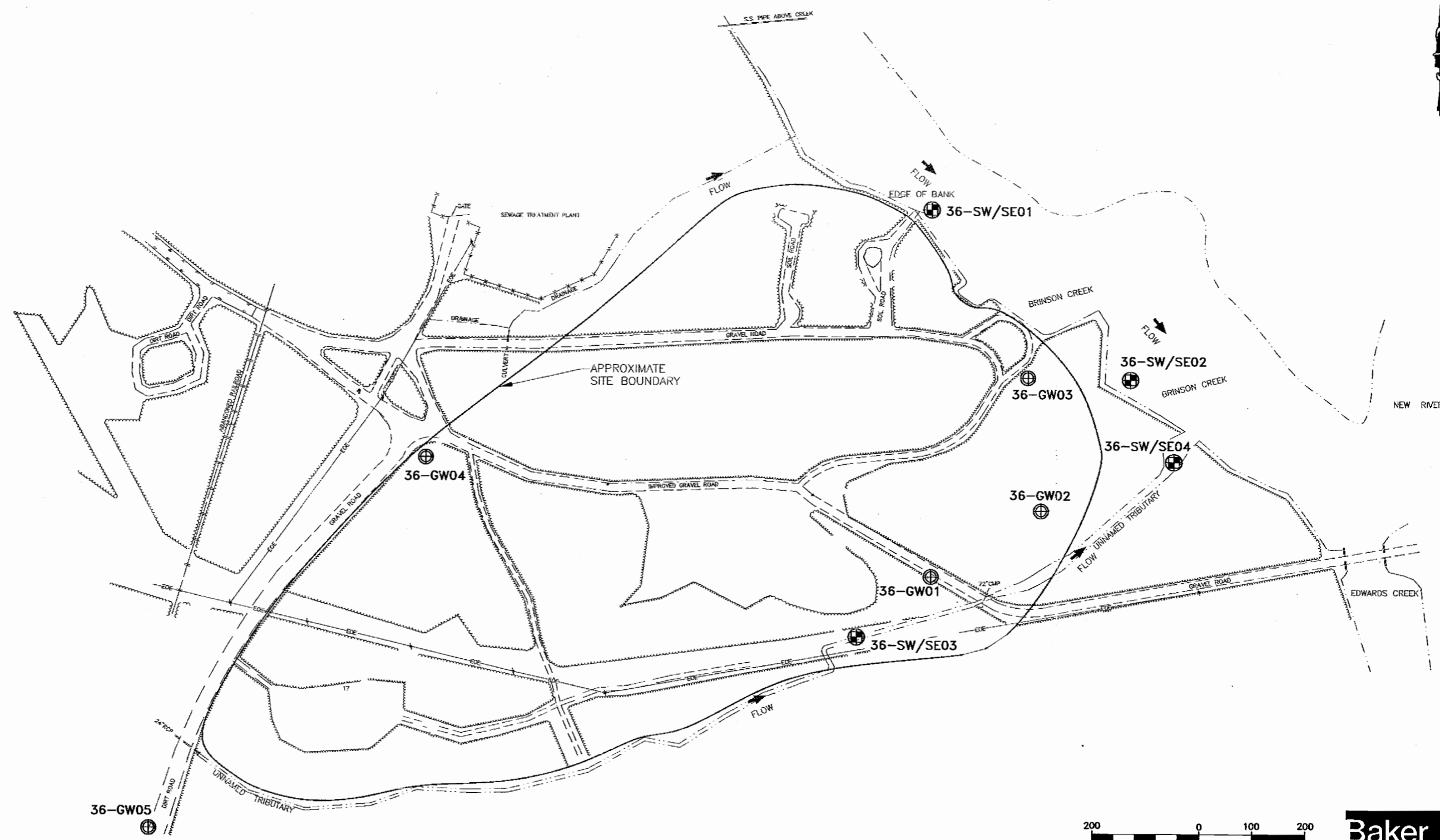
- FLOW DIRECTION OF SURFACE WATER FLOW
- EOE OVERHEAD ELECTRIC LINE & UTILITY POLE
- - - FENCE
- ▨ ASPHALT ROAD
- - - GRAVEL ROAD
- - - EDGE OF CREEK, DRAINAGE DITCH, MARSH OR POND
- ~ TREE LINE



<p>REVISIONS</p>	<p>DRAWN REL REVIEWED TFT S.O.# 62470-303 CADD# 303004R1</p>	<p>NORTH</p>	<p>REMEDIAL INVESTIGATION, CTO-0303 MARINE CORPS BASE, CAMP LEJEUNE NORTH CAROLINA</p> <p>BAKER ENVIRONMENTAL, Inc. Coraopolis, Pennsylvania</p>		<p>FIGURE No. 1-5</p>
				<p>SCALE 1" = 80'</p>	<p>DATE JANUARY 1996</p>

SOURCE LAND DIV. FEBRUARY 1992
SURVEY BRENT A LANIER AND ASSOCIATES, 1995

C:\WORK\1996\1-5\1-5.DWG
 1/11/96 10:30 AM
 1/11/96 10:30 AM
 1/11/96 10:30 AM

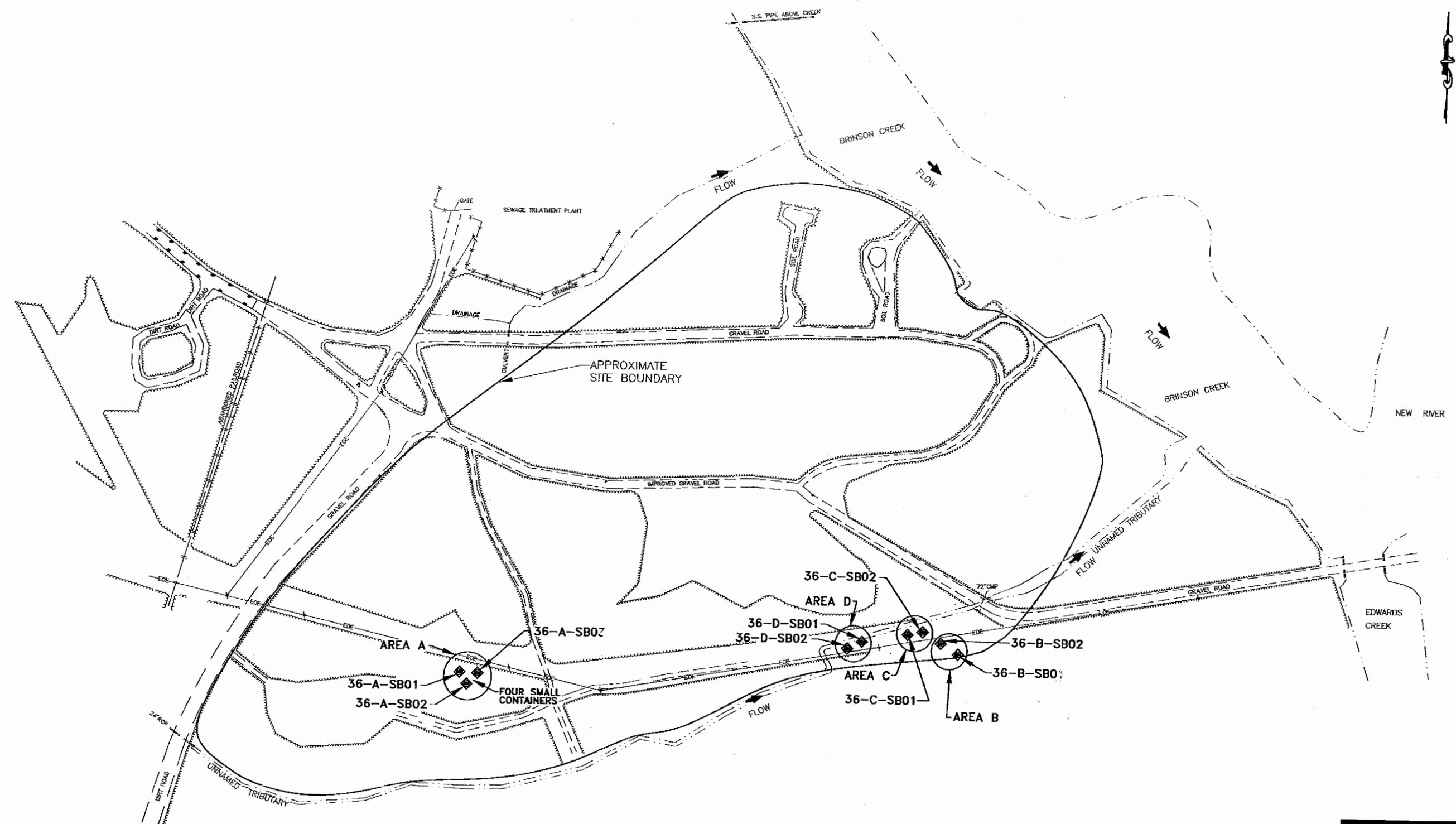


Baker
Baker Environmental, Inc.

- | | | | |
|------------|--|---------|---------------------------------------|
| 36-GW01 | SHALLOW MONITORING WELL (ESE, 1984/1986) | → FLOW | DIRECTION OF SURFACE WATER FLOW |
| 36-SW/SE01 | SURFACE WATER AND SEDIMENT SAMPLING LOCATION (APPROXIMATE) | — EOE — | OVERHEAD ELECTRIC LINE & UTILITY POLE |
| | | -x-x- | FENCE |
| | | ===== | ASPHALT ROAD |
| | | ----- | GRAVEL ROAD |
| | | ~~~~~ | EDGE OF CREEK, RIVER, OR DRAINAGE |
| | | ~~~~~ | TREE LINE |

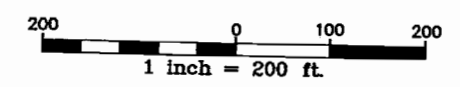
FIGURE 1-6
CONFIRMATION STUDY SAMPLING LOCATIONS
SITE 36, CAMP GEIGER DUMP AREA
REMEDIAL INVESTIGATION, CTO-0303
MARINE CORPS BASE, CAMP LEJEUNE
NORTH CAROLINA

01710YB3Z



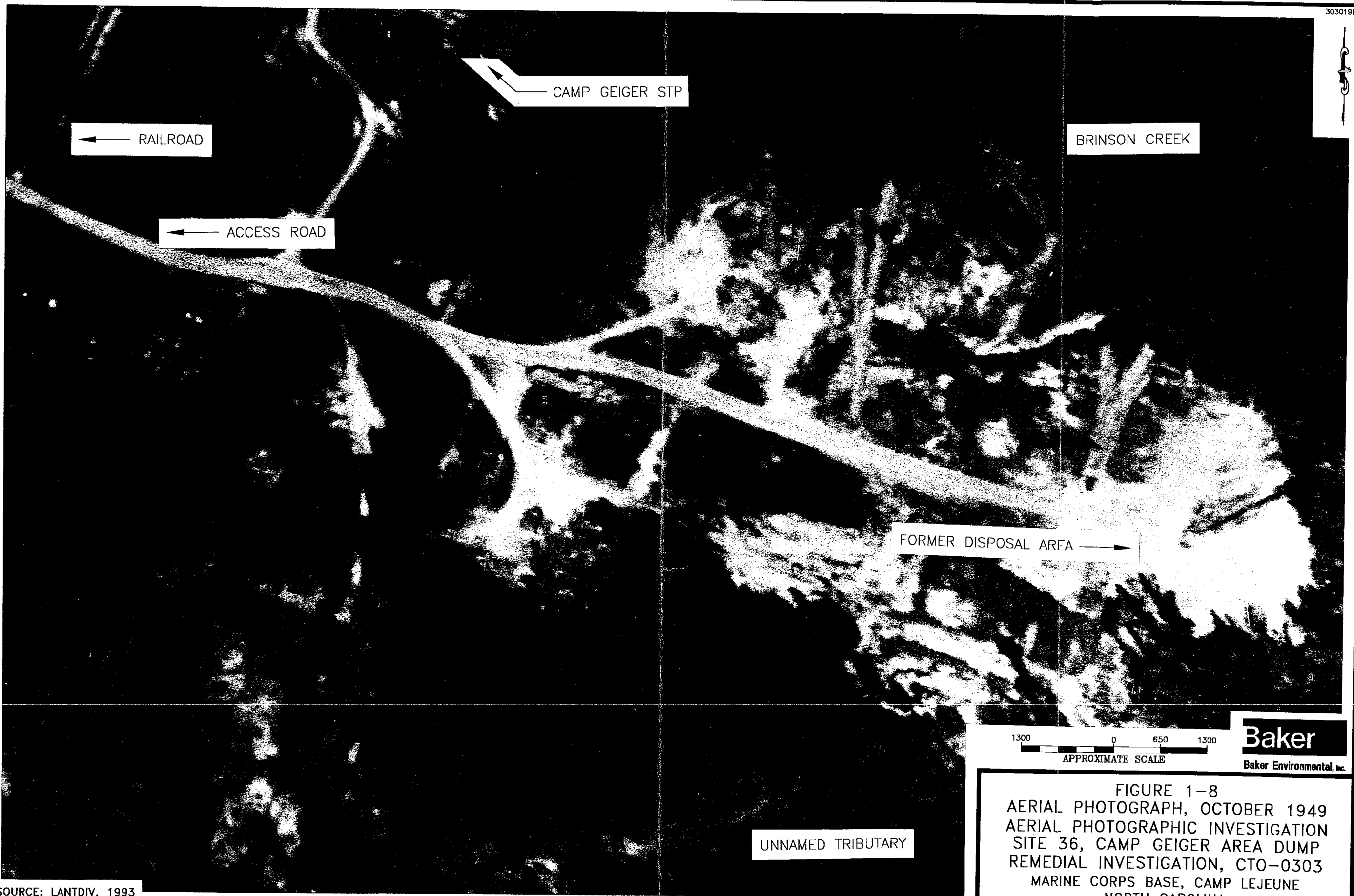
LEGEND

- SOIL BORING LOCATION
- FLOW
- OVERHEAD ELECTRIC LINE & UTILITY POLE
- FENCE
- ASPHALT ROAD
- GRAVEL ROAD
- EDGE OF CREEK, RIVER, AND DRAINAGE
- TREE LINE



Baker
Baker Environmental, Inc.

FIGURE 1-7
DRUM AND/OR CONTAINER AREAS
RI SCOPING SOIL INVESTIGATION
SITE 36, CAMP GEIGER AREA DUMP
REMEDIAL INVESTIGATION, CTO-0303
MARINE CORPS BASE, CAMP LEJEUNE
NORTH CAROLINA



← RAILROAD

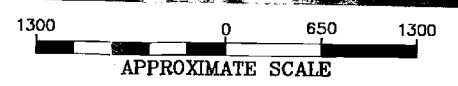
← ACCESS ROAD

CAMP GEIGER STP

BRINSON CREEK

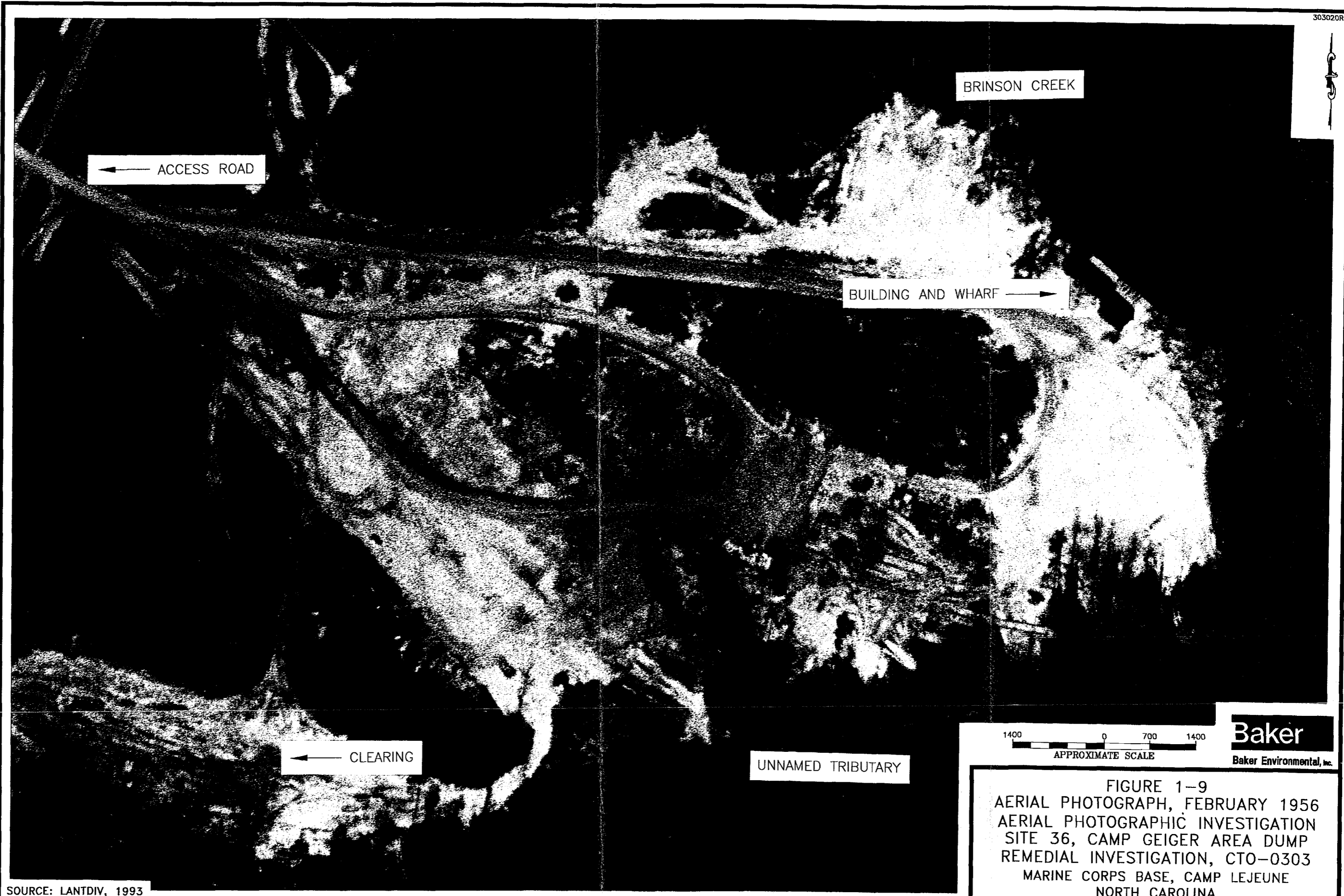
FORMER DISPOSAL AREA →

UNNAMED TRIBUTARY



Baker
Baker Environmental, Inc.

FIGURE 1-8
AERIAL PHOTOGRAPH, OCTOBER 1949
AERIAL PHOTOGRAPHIC INVESTIGATION
SITE 36, CAMP GEIGER AREA DUMP
REMEDIAL INVESTIGATION, CTO-0303
MARINE CORPS BASE, CAMP LEJEUNE
NORTH CAROLINA

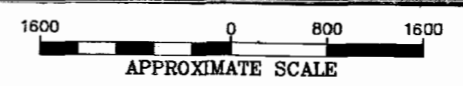


SOURCE: LANTDIV, 1993

1400 0 700 1400
APPROXIMATE SCALE

Baker
Baker Environmental, Inc.

FIGURE 1-9
AERIAL PHOTOGRAPH, FEBRUARY 1956
AERIAL PHOTOGRAPHIC INVESTIGATION
SITE 36, CAMP GEIGER AREA DUMP
REMEDIAL INVESTIGATION, CTO-0303
MARINE CORPS BASE, CAMP LEJEUNE
NORTH CAROLINA



Baker
Baker Environmental, Inc.

FIGURE 1-10
 AERIAL PHOTOGRAPH, DECEMBER 1960
 AERIAL PHOTOGRAPHIC INVESTIGATION
 SITE 36, CAMP GEIGER AREA DUMP
 REMEDIAL INVESTIGATION, CTO-0303
 MARINE CORPS BASE, CAMP LEJEUNE
 NORTH CAROLINA



BRINSON CREEK

NEW RIVER

CLEARING

FORMER DISPOSAL AREA

CLEARING

EDWARDS CREEK

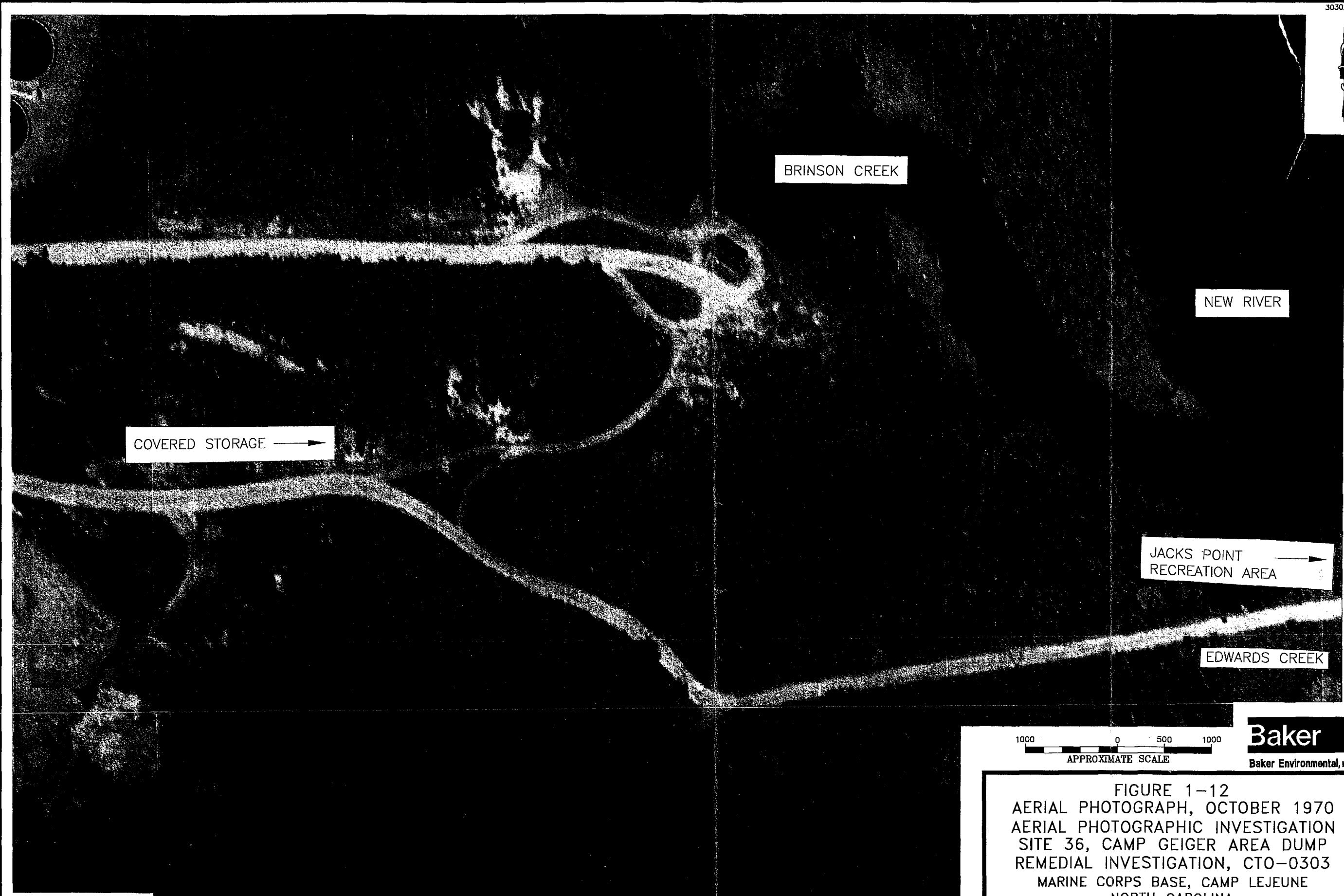
1600 0 800 1600

APPROXIMATE SCALE

Baker

Baker Environmental, Inc.

FIGURE 1-11
AERIAL PHOTOGRAPH, FEBRUARY 1964
AERIAL PHOTOGRAPHIC INVESTIGATION
SITE 36, CAMP GEIGER AREA DUMP
REMEDIAL INVESTIGATION, CTO-0303
MARINE CORPS BASE, CAMP LEJEUNE
NORTH CAROLINA



BRINSON CREEK

NEW RIVER

COVERED STORAGE →

JACKS POINT RECREATION AREA →

EDWARDS CREEK

1000 0 500 1000
APPROXIMATE SCALE

Baker
Baker Environmental, Inc.

FIGURE 1-12
 AERIAL PHOTOGRAPH, OCTOBER 1970
 AERIAL PHOTOGRAPHIC INVESTIGATION
 SITE 36, CAMP GEIGER AREA DUMP
 REMEDIAL INVESTIGATION, CTO-0303
 MARINE CORPS BASE, CAMP LEJEUNE
 NORTH CAROLINA

2.0 SITE CHARACTERISTICS

Section 2.0 of this report presents information on site-specific physical characteristics. This section includes a discussion on the topography, surface water hydrology and drainage features, geology, hydrogeology, and ecology at Site 36.

2.1 Topography and Surface Features

The relief of Site 36 is generally low with surface elevations ranging from 3 to 17 feet above mean sea level (MSL). A ridge is evident generally trending east/west through wells 36-GW08, 36-GW09 and 36-GW11 (Figure 2-1). A distinct mound is present on the eastern edge of the ridge. The highest point of the ridge occurs on this mound, and is approximately 17 ft above MSL (near 36-GW11). Both ridge and mound appear to be man-made features. Past disposal and regrading is evident in an area corresponding to the ridge based on soil boring information and aerial photographs. The northern side of the ridge slopes gently northeast toward Brinson Creek. The southern side of the ridge slopes gently south, toward the unnamed tributary of the New River. This gentle slope is interrupted by a steep slope extending between wells 36-GW07 and 36-GW08, and has a drop of approximately 5 feet. The eastern point of the ridge falls steeply, east and south, to low, flat land adjacent to Brinson Creek. The elevation difference between the ridge top and the lowland is approximately 15 feet.

2.2 Surface Water Hydrology

Surface water movement is limited at Site 36 due to the low topography over much of the site, heavily vegetated fields, and woodlands. At the time of the investigation (particularly in February and March, 1995), ponded water and saturated soils were observed throughout much of the site. This was especially apparent in the vicinity of well nest 36-GW06/06DW, the access road to the "FCA" borings, and in the open field in the center of the site (Figure 2-1).

The southern side of the site, adjacent to the unnamed tributary consists of low, flat land. At the time of the investigation, wetland vegetation was observed, along with ponded water and saturated soils. It is apparent that surface water runoff (and groundwater) collects in this area and slowly drains to the unnamed tributary and the New River.

2.3 Soil

According to the Soil Conservation Service (SCS) Soil Survey of Camp Lejeune, North Carolina (1984), Site 36 is underlain primarily by the Baymeade (BaB) urban land complex. A second unit, the Marvyn (MaC) soil complex, bounds the site on the east. The Baymeade complex is typically found in areas where the original soil has been cut, filled, or graded. Soil properties of this unit have been altered through slope modification and smoothing. Generally, Baymeade soils are moderately to strongly acidic and are classified under the SCS as fine sand (SM-SP) and loamy fine sand (SM). The Marvyn complex generally appears in long and narrow bands, typically on the side of slopes (6 to 15 percent grade) near large drainage areas (eg., Brinson Creek). Marvyn soils are classified by the SCS as SM. Table 2-1 provides a summary of soil physical properties found at Site 36.

2.4 Geology

A fairly consistent depositional sequence was observed in borings throughout Site 36. This observed sequence is similar to the generalized North Carolina coastal plain sequence shown in Figure 1-1. The uppermost beds are undifferentiated. The surficial aquifer lies within the sediments of this undifferentiated formation. In the generalized sequence of Figure 1-1, less permeable sediments below the undifferentiated formation comprise the Belgrade Formation, also called the Castle Hayne confining unit. According to Cardinell et al., 1993, the Belgrade Formation constitutes part of the surficial aquifer and Castle Hayne confining unit. In this report for the purpose of simplicity, the less permeable sediments below the undifferentiated formation will be referred to as a distinct unit; the Belgrade Formation (Castle Hayne confining unit). The River Bend Formation lies below the Belgrade Formation and is primarily characterized by beds of partially cemented shell fragments. The upper portion of the Castle Hayne aquifer lies within sediments of the River Bend Formation. The generalized sequence (Figure 1-1) shows that the Yorktown, Eastover, and Pungo River Formations lies between the undifferentiated and Belgrade Formation. However, the Yorktown, Eastover, and Pungo River Formations have not been identified at Camp Lejeune.

Much of the surface soil and sediment at the site has been disturbed by human activity, as evidenced by mounds, ridges, roads, and cleared areas observed throughout the site. Additionally, debris and soil have been disposed on portions of the site that resulted in the ridge and mound discussed in Section 2.1. Generally, regraded soil and debris were encountered in borings in the southern portion of Site 36 (Figure 2-1). The soil was observed to be predominantly sand, silt and clay, with a lesser amount of debris. The debris included rocks, glass, metal, bricks and wood.

The uppermost formation at Site 36, the undifferentiated Formation, is comprised of several units of Holocene and Pleistocene ages. This formation typically extends to a depth between 30 and 40 feet bgs. A fine sand, with lesser amounts of silt and clay occupies the uppermost portion of the formation. This sand unit is typically 5 feet thick. Below the sand is a clay layer with lesser amounts of fine sand and silt, approximately 2 to 5 feet thick. A second fine sand layer is below the clay. Zones of medium and coarse sand are present within this second sand unit. This sand unit also contains a lesser amount of silt and clay, and is approximately 5 to 15 feet thick. Additionally, laminae features are distinct in some portions of the unit. A unit composed of predominantly shell fragments lies below the second sand. This unit also contains of a lesser amount of fine sand, silt, and clay. This unit occupies the lower portion of the formation, and is 15 to 20 feet thick. The sands of the undifferentiated Formation tend to be loose to medium dense, the clays are soft to medium stiff, and the shell fragment layer is dense to very dense.

The Belgrade Formation is comprised of fine sand with lesser amounts of shell fragments, silt, and clay of the Miocene age. The top of this formation lies 30 to 40 feet bgs, is 15 to 20 feet thick, and has a distinct green or greenish-gray color. The sediments of this formation are medium dense to dense.

The River Bend Formation is comprised of fine to medium sand, with lesser amounts of shell fragments, silt, and clay of the Oligocene age. This formation lies approximately 60 feet bgs at Site 36. The sediments of this formation are very dense.

Geologic cross-sections depicting the shallow and deep soil lithologies were developed based on soils collected during the RI. Boring logs are provided in Appendix A and well boring and

construction logs are provided in Appendix B. Figure 2-1 shows the locations of the cross-sections traversing Site 36 and Figure 2-2 depicts the lithologies.

Cross-section A-A' typifies the undifferentiated-Belgrade-River Bend sequence. Fill is absent along this section. The clay unit of the undifferentiated Formation extends the length of the section, and thins to the west. This clay unit was observed to be damp to moist and appears to be a zone of lower permeability inhibiting, but not precluding downward groundwater flow. The shell fragment unit is generally more coarse-grained than the sediments above it. The Belgrade Formation sediments were observed to be damp and may be locally inhibiting, but not precluding downward groundwater movement to the River Bend Formation.

Cross-section B-B' does not show the upper sand unit of the undifferentiated Formation. Stream action may have eroded the sand unit and left the clay unit, then redeposited sandy sediments along the southern end of the section. Subsequently, soil and debris were disposed, resulting in the mound. Again, the Belgrade Formation is present, and may inhibit groundwater movement to the River Bend Formation.

Cross-section C-C' traverses west to east through the fill area. This cross-section shows that only the upper portion of the undifferentiated Formation has been penetrated. The upper sandy unit is completely missing, again possibly due to stream erosion. The low-land areas appear to have been filled. The clay unit is not as thick nor as extensive in this section as compared to section A-A'. The clay unit has been replaced by thin, alternating layers of fine sand and clay in the western portion of C-C'.

Cross-section D-D' traverses north to south, along the western end of the site. This section shows that only the upper portion of the undifferentiated Formation has been penetrated. A clay layer extends across the length of the section. The clay thickens considerably and is at the surface at 36-GW05. At 36-GW14 and 36-BB-SB01 the clay may locally retard groundwater movement, based on the lack of moisture in this unit. A coarse sand lens is present at 36-GW05 and likely represents an area of relatively high permeability. Because this lens appears to be limited in extent, it is not likely a significant flow path.

Cross-section E-E' traverses west to east through the fill area. This cross-section shows that only the upper portion of the undifferentiated Formation has been penetrated. The sand unit appears partially eroded in Section E-E', again possibly due to stream erosion. This area has been subsequently filled. The clay unit is not as thick nor as extensive in either section as compared to section A-A'.

Cross-section F-F' traverses north to south, on a line west of the disturbed area. This section shows that only the upper portion of the undifferentiated Formation has been penetrated. A clay layer extends across the length of the section, but is thin and was observed to be saturated. A coarse sand lens is present at 36-GW04 and may exhibit a relatively high hydraulic conductivity. Because this lens appears to be limited in extent, it is not likely to represent a significant flow path.

Cross-section G-G' traverses north to south, partially into the disturbed area. This section shows that the River Bend Formation is present at 36-GW12IW. Fill has replaced the upper sand and clay units at the southern end of the section.

2.5 Hydrogeology

There are several aquifers beneath Site 36 and vicinity. The upper two aquifers were investigated in this study, the surficial and Castle Hayne. The surficial aquifer occurs within the sediments of the undifferentiated Formation and is within 10 feet of the surface. It is approximately 25 to 30 feet thick in the vicinity of Site 36 and is unconfined (i.e., water table aquifer). The upper portion of the Castle Hayne aquifer occurs within the sediments of the River Bend Formation. The Castle Hayne aquifer occurs approximately 60 feet bgs and is approximately 200 feet thick in the vicinity of Camp Geiger and the Air Station (Cardinell et al., 1993). The Belgrade Formation, situated between the undifferentiated and River Bend Formations, is also known as the Castle Hayne confining unit. The Castle Hayne confining unit is approximately 17 to 23 feet thick at Site 36.

Hydrogeologic conditions were evaluated by installing a network of shallow, intermediate, and deep monitoring wells. A staff gauge was installed in the unnamed tributary, near its mouth at the New River to monitor creek levels.

2.5.1 Groundwater Elevation Data

Groundwater and surface water elevation data for Site 36 are summarized on Table 2-2. Four rounds of groundwater level measurements were collected in March, April, May and August of 1995. Additionally, water level data was collected from the shallow/deep pairs in October.

Shallow monitoring wells are screened to intercept the water table and average a depth of approximately 20 feet bgs. The intermediate wells (designated with "IW") are screened immediately above the Castle Hayne confining unit, to monitor the lower portion of the surficial aquifer. The intermediate wells average depth is approximately 34 feet bgs. The deep wells (designated with "DW") are screened immediately below the Castle Hayne confining unit, to monitor the upper portion of the Castle Hayne aquifer. The deep wells average depth is approximately 68 feet bgs.

The groundwater elevation data in all wells exhibit a downward trend between March and May (Figure 2-3A through E). The decrease in elevation ranged from approximately 1 to 2.5 feet, with an average decrease of approximately 1.5 feet. This data trend is likely attributable to a lack of precipitation during the time period.

An increase in groundwater elevations was observed between May and August in wells 36-GW01, 36-GW03, and 36GW09 through 36-GW13. The increase ranged from approximately 0.1 to 0.8 feet with an average increase of 0.3 feet. The increase occurred in wells on the eastern and northern side of the site; wells nearest Brinson Creek. This trend may be related to creek level fluctuations.

An increase in groundwater elevations was observed between August and October in all wells monitored. The elevations increased ranged from approximately 0.5 feet to 3 feet. This increase is likely attributable to the precipitation during the period.

The Castle Hayne confining unit appears to exhibit leakage, based on groundwater elevation comparisons. The average groundwater elevation decrease between March and May in the shallow wells was 2.4 feet. The average groundwater elevation decrease during the same period in the deep wells was 2.8 feet; 0.4 feet greater than the shallow wells. Additionally, the elevation trends between March and October in the surficial and Castle Hayne aquifers are similar. These two points suggest a similar response to precipitation/atmospheric changes between the aquifers.

Vertical flow direction between the two aquifers is inconsistent. The elevation differences in wells 36-GW07/07DW, 36-GW10/10DW, and 36-GW11/11DW varies between March and October. Only well pair 36-GW06/06DW exhibits a consistent trend (downward).

2.5.2 Groundwater Flow Contour Maps

Groundwater elevation contour maps were developed from static water level data collected between March and August of 1995. Shallow groundwater flow patterns were similar in March, May, and August. Intermediate and deep groundwater flow patterns were also similar between May and August. Since the patterns are similar, contour maps using only the August 1995 data are presented so that a maximum number of data points could be used and a single point-in-time comparison could be made. The contour maps are presented as Figures 2-4 and 2-5 for the shallow and deep wells, respectively. The intermediate groundwater contour map was not included due to limited areal extent and consistent flow pattern with shallow contours. Flow gradients were determined by dividing a certain distance of a flow line (or distance between two wells) into the change in groundwater elevation over that distance.

Horizontal groundwater flow in the upper portion of the surficial aquifer is generally to the east and northeast across Site 36. A northern component of flow is evident in the vicinity of 36-GW10 and 36-GW12. Flow gradients are fairly consistent in the middle of the site and over time. The gradient ranges from 0.02 feet/foot to 0.06 feet/foot. The gradient decreases substantially near Brinson Creek. This is particularly evident between wells 36-GW12 and 36-GW10, where the contours spread out and the gradient is approximately 0.0004 feet/foot. The close spacing of contours between wells 36-GW06 and 36-GW14 may represent a "back-up" effect; groundwater flow is slowing as it flows through relatively less permeable sediments. Cross-section A-A' shows the wells to be screened in relatively finer grained sediments. Additionally, the hydraulic conductivity in the vicinity of well 36-GW06 appears to be relatively low (discussed in Section 2.5.3).

Horizontal flow of groundwater in the upper portion of the Castle Hayne aquifer is generally to the northeast across the site. The flow gradient is approximately 0.003 feet/foot across the site. The flow gradient in the Castle Hayne aquifer is more shallow than in the surficial aquifer, and appears consistent across the site.

Based on groundwater flow direction and the decrease in gradient close to streams, it appears that the surficial aquifer discharges to Brinson Creek. Based on the groundwater flow direction and consistent gradient, it appears that the Castle Hayne flows underneath Brinson Creek. Groundwater elevation data compiled and mapped by Cardinell indicate that groundwater in the Castle Hayne aquifer flows toward, and discharges to the New River and its major tributaries.

2.5.3 Hydraulic Properties

Rising and falling head slug tests were conducted at Site 36 on several shallow and deep monitoring wells. The slug test data were analyzed using the Bower-Rice method on AQTESOLV Version 2.0 software. The solutions are presented in Appendix N and summarized on Table 2-3.

Rising head test data is used in the text discussions. Falling head test data was used where available as a check against the rising head data. The falling head test is equally valid to the rising head when the static water level is above the screen interval. The static water level in several wells was within the screened interval. These falling head data sets were not analyzed.

Transmissivity is the hydraulic conductivity multiplied by the saturated thickness of the aquifer. The calculated transmissivity of the Castle Hayne aquifer is one to three orders of magnitude higher than the surficial aquifer. This is because the thickness of the Castle Hayne is 160 feet compared to a 30 foot saturated thickness of the surficial aquifer. Also, the hydraulic conductivity of the Castle Hayne is typically higher than in the surficial aquifer.

The sediments of the surficial aquifer tend to be relatively fine grained. These sediments exhibit hydraulic conductivities on the order of 0.6 to 4.2 feet/day (10^{-3} to 10^{-4} cm/sec), typical for such relatively fine grained sediments (Fetter, 1988). The hydraulic conductivity values tend to vary from well to well rather than within a single test. This may be due to the varying composition of the surficial aquifer. Well 36-GW07 exhibited the highest hydraulic conductivity at 4.2 feet/day (1.48×10^{-3} cm/sec). A medium grained sand layer is situated within with screened interval. Well 36-GW06 exhibited the lowest hydraulic conductivity at 0.6 feet/day. A silty clay layer is present within the screened interval.

In general the sediments of the Castle Hayne are coarser than those of the surficial aquifer. The hydraulic conductivities also tend to be higher and range from 3.0 to 7.8 feet/day. Again, the hydraulic conductivity values tend to vary, with the varying composition.

The surficial aquifer hydraulic conductivity values are an order of magnitude lower than the value presented in the Cardinell's report. The average hydraulic conductivity at Site 36, based on RI slug tests is 2.4 feet/day, compared to 50 feet/day presented by Cardinell. Cardinell provided an estimated hydraulic conductivity value of 50 feet/day. The Cardinell value was based on a general composition of fine sand, mixed with some silt and clay. The surficial aquifer at Site 36 may contain more fine-grained sediments than accounted for by Cardinell's estimate assumptions. The average hydraulic conductivity and transmissivity for the Castle Hayne aquifer at Site 36 is 5.7 feet/day and 1,248 feet/day, respectively. Cardinell's report presents hydraulic conductivities and transmissivities from several studies. Hydraulic conductivities range from 14 to 91 feet²/day and transmissivities range from 820 to 26,000 feet/day. The RI results for Site 36 are comparable with other sites throughout Camp Lejeune.

2.5.4 Groundwater Flow Velocities

Groundwater flow velocities can be estimated using a variation of Darcy's equation:

$$V = Ki/n_e$$

where:

- V = groundwater velocity (feet)
- K = Hydraulic conductivity (feet/day)
- i = horizontal gradient (feet/foot)
- n_e = effective porosity

Velocity calculations are presented in Appendix O. "K" values were determined from slug tests conducted at wells 36-GW06, 36-GW07, 36-GW09, 36-GW11, 36-GW06DW, 36-GW07DW, and 36-GW11DW. Surficial aquifer hydraulic conductivity values ranged from 0.6 feet/day at 36-GW06 to 4.2 feet/day at 36-GW07. Castle Hayne aquifer hydraulic conductivity values ranged from 3.0 feet² day at 36-GW11DW to 7.8 feet/day at 36-GW07. Flow gradient values were determined by using groundwater contours (Section 2.5.3). An effective porosity value of 30 percent was used

(estimated from Fetter, 1988) based on the silty sands underlying the site. Though the Castle Hayne sediments are coarser than the surficial sediments, they are more compacted. Thus, a value of 30 percent was also used.

The calculated groundwater flow velocities were fairly consistent across the site for both the surficial and Castle Hayne aquifers; ranging from 0.02 feet/day to 0.08 feet/day, with an average of 0.05 feet/day.

2.5.5 General Groundwater Flow Patterns

Groundwater flow in the surficial aquifer at Site 36 is toward Brinson Creek east of the site, with an average velocity of 0.05 feet/day. Groundwater flow in the upper Castle Hayne aquifer is to the northeast, with an average velocity of 0.06 feet/day. Because the hydraulic conductivity varies, groundwater may exhibit preferential flow paths following the relatively highly conductive medium and coarse sands. There also appears to be some degree of connection between the surficial and Castle Hayne aquifers based on the hydrographs presented in Section 2.5.1.

Brinson Creek and the unnamed tributary, represent a groundwater flow boundary for the surficial aquifer at Site 36. It appears that groundwater in the surficial aquifer discharges to Brinson Creek based on the elevation of the creek relative to groundwater elevations and groundwater flow direction.

Groundwater flow in the upper 10 to 15 feet of the surficial aquifer is complicated by the presence of a clayey layer under much of the site. The position of the clay layer roughly corresponds to the water table. During drilling, water was observed in sands and silts above the clay in the western portion of the site. It appears that water infiltrating the sands and silts is slow to infiltrate around/through the clay layer, creating a thin, perched groundwater zone. This perched zone may be seasonal. Baker personnel observed a significant amount of rain prior to the start of field activities. Many low-lying areas of the site contained ponded water or saturated soils. Additionally, the perched zone was typically less than 1 foot thick, and limited in extent. No perched zone was evident during drilling in the eastern portion of the site. There, the depth to groundwater tended to be within or below the clay unit.

2.6 Identification of Water Supply Wells

Potable water supply wells within a one-mile radius of the site were identified by reviewing the Wellhead Management Program Engineering Study (Geophex, Ltd., 1991). Ten water supply wells were identified within the one-mile radius. Five of the wells were reported to be operating. Table 2-4 summarizes some well construction details and Figure 2-6 shows the location of the supply wells. These supply wells are located upgradient of Site 36 based on their location with respect to northeasterly groundwater flow direction under Site 36. Additionally, it appears that these supply wells have not altered groundwater flow at Site 36 based on the groundwater flow patterns.

Seven of the ten supply wells were sampled in 1992 (Greenhorne & O'Mara, 1992). Detected compounds are presented on Table 2-4. No organic compounds were detected in any of the wells listed however, several inorganic analytes were. The USEPA has established secondary maximum concentration limits (SMCLs) for several of the detected analytes. North Carolina has also established Standards for several of the detected analytes. The Aluminum SMCL was exceeded in

all wells sampled, except MCAS-131. The iron, manganese, and TDS Standards/SMCLs were exceeded in several wells. The Standard for Fluoride was exceeded only in TC-502.

Aluminum, iron, and manganese appear to be prevalent across Camp Lejeune. The presence of these metals in water supply wells at these concentrations appears to be representative of base-wide conditions.

2.7 Ecology

Two types of wetlands are present at Site 36. Estuarine, intertidal, subshrub, broad-leaved evergreen, needle-leaved evergreen, irregularly flooded wetlands are found along Brinson Creek, Edwards Creek, and the New River. Along the drainage ways and the unnamed tributaries to the creeks palustrine, forested, broad-leaved deciduous, needle-leaved evergreen, temporarily flooded wetlands are present.

Apart from the wetlands, no sensitive environments were identified at site 36 studied during this remedial investigation. No endangered species were noted during the habitat evaluation nor were endangered species referenced at any of the sites during the endangered species survey (LeBlond, 1994).

Three general habitat types are present at Site 36. Mixed forest is found over much of the site area, while more open habitat is found in the former disposal areas and along the roads. The mixed forest becomes wooded swamp in the lower areas along Brinson Creek and its unnamed tributaries. These swamps grade to salt marsh along the banks of the creek. Figure 2-7 shows a biohabitat map for the Site 36 area.

The mixed forest is dominated by loblolly pine (*Pinus taeda*). Other trees present in the canopy include longleaf pine (*Pinus australis*), water oak (*Quercus nigra*), white oak (*O. alba*), southern red oak (*O. falcata*), sweetgum (*Liquidambar styraciflua*), and tulip poplar (*Liriodendron tulipifera*). In addition to saplings of the canopy trees, the understory contains both shrubs and vines. Shrub species include juniper (*Juniperus virginianus*), sweet myrtle (*Myrica cerifera*), silk tree (*Albizia julbrisin*), flowering dogwood (*Cornus florida*), and sweetbay (*Magnolia virginiana*). The vines greenbriar (*Smilax rotundifolia*), Japanese honeysuckle (*Lonicera japonica*), and jasmine (*Gelsemium sempervirens*) are also present. Vegetation on the floor of this mixed forest is sparse. In addition to occasional seedling trees and vines, spotted wintergreen (*Chimaphila maculata*) is found.

In the open areas species from the mixed forest are interspersed with field plants. No species of tree is dominant in the open areas, although loblolly pine (*Pinus taeda*), sweetgum (*Liquidambar styraciflua*), honey locust (*Gleditsia tricanthos*), and sassafras (*Sassafras albidum*) were common. Sapling trees are mixed with shrubs and vines including the following species:

- Privet- *Ligustrum vulgare*
- Blackberry- *Rubus* sp.
- Dewberry- *Rubus hispidus*
- Shining Sumac- *Rhus copallina*
- Wild Rose- *Rosa palustris*
- Sweetleaf- *Symplocos tinctoria*
- Japanese Honeysuckle- *Lonicera japonica*
- Jasmine- *Gelsemium sempervirens*

- Bullbriar- Smilax bona-nox
- Trumpet Creeper- Campsis radicans

Herbaceous annuals and perennials are common in the open area, although no individual specie is dominant. Grasses are present and are mixed with the following:

- Broom Sedge- Andropogon virginianus
- Narrow-leaved Plantain- Plantago lanceolata
- Sweet White Clover- Melilotus alba
- Dog Fennel- Eupatorium capillifolium
- Vetch- Vicia sp.
- Lyre-leaved Sage- Salvia lyrata
- Coffee Senna- Cassia occidentalis
- Verbena- Verbena brasiliensis
- Goldenrod- Solidago ssp.
- Bushy Beardgrass- Andropogon glomeratus
- Ebony Spleenwort- Asplenium platyneuron
- Carolina Geranium- Geranium carolinianum
- Mouse-ear Chickweed- Cerastium vulgare
- Peppergrass- Lepidium virginicum
- Thistle- Cirsium sp.

Swamps or forested wetlands are present along Brinson Creek and its tributaries that drain the site. Trees are dominant in this swamp, although no single specie is dominant. Trees identified in the swamp include

- Loblolly- Pinus taeda
- Red Maple- Acer rubrum
- Water Oak- Quercus nigra
- Hornbeam- Carpinus caroliniana
- Water Elm- Planera aquatica
- Ash- Fraxinus sp.
- Bald Cypress- Taxodium distichum

Saplings, smaller tree varieties, and shrubs are found in the understory of the swamp. The understory includes the following:

- Juniper- Juniperus virginianus
- Sweetbay- Magnolia virginiana
- Groundsel tree- Baccharis halimifolia
- Redbay- Persea borbonia
- Coastal Plain Willow- Salix caroliniana
- Sweet Myrtle- Myrica cerifera
- Trumpet Honeysuckle- Lonicera sempervirens

The floor of the swamp supports wetland vegetation including switch cane (Arundinaria tecta), giant cane (A. gigantea), swamp dock (Rumex verticillatus), seaside goldenrod (Solidago sempervirens), hydrocotyl (Hydrocotyl americana), and arrow arum (Peltandra virginica).

The vegetation of the swamp changes dramatically along the creek where it becomes salt marsh. This marsh is dominated by salt marsh cord grass (Spartina alterniflora) mixed with big cordgrass (S cynosuroides), cattails (Typha ssp.), alder (Alnus ssp.) and scattered bald cypress (Taxodium distichum).

Because of the variety of habitats a number of birds and animals were observed at Site 36 during the habitat evaluation. The birds included resident and migratory songbirds and water birds. The following species were noted:

- Crow- Corvus brachyrhynchos
- Carolina Wren- Thryothorus ludovicianus
- Carolina chickadee- Parus carolinensis
- Red-bellied Woodpecker- Melanerpes carolinus
- Flycatcher- Empidonax ssp.
- Myrtle Warbler- Dendroica coronata
- Canada Goose- Branta canadensis
- Mourning Dove- Zenaida macroura
- Robin- Turdus migratorius
- Brown Pelican- Pelecanus occidentalis
- Cardinal- Richmondia cardinalis
- Cedar Waxwing- Bombycilla cedrorum
- Blue-grey Gnatcatcher- Poliophtila caerulea
- Yellowthroat- Geothlypis trichas
- Grackle- Quiscalus quiscula
- Yellow Warbler- Dendroica petechia
- Pied-bill Grebe- Podilymbus podiceps
- Red-cockaded Woodpecker- Picoides borealis

The water birds were observed in or along Brinson Creek, while the other birds were observed throughout the site.

Signs of mammals were also noted during the field study. Tracks, a buck-rubbed tree, and a trail, all signs of deer (Odocoileus virginianus) were observed as were tracks and droppings of raccoons (Procyon lotor). A squirrel nest (Scuirus sp.) was found in the mixed forest and tunnels of a mole (Scalopus aquaticus) were also observed.

Reptiles and amphibians were seen during the field study. Green tree frogs (Hyla cinera) were observed both in the mixed forest and in the open area. Anoles (Anolis carolinensis) were present in the forested areas and green frogs (Rana clamitans) were noted in the tributaries to Brinson Creek.

2.8 References

Barnhill, W.L. 1984. Soil Survey of Camp Lejeune, North Carolina. USDA, Soil Conservation Service.

Cardinell, A.P., Berg, S.A., and Lloyd O.B. Jr. 1993. Hydrogeologic Framework of U.S. Marine Corps Base at Camp Lejeune, North Carolina. USGS. Water-Resources Investigations Report 93-4049.

Fetter, C.W. 1986. Applied Hydrogeology. Charles E. Merrill Publishing Co., Columbus, Ohio.

Geophex, Ltd. 1992. Wellhead Management Program Engineering Study 91-36. Prepared for Marine Corps Base, Camp Lejeune, North Carolina. January 22, 1992.

Greenhorne & O'Mara. 1992. Preliminary Draft Report Wellhead Monitoring Study. Prepared for the Department of the Navy, Civil Branch. December, 1992.

Harned, D.A., Lloyd, O.B., Jr., and Treece, M.W., Jr. 1989. Assessment of Hydrologic and Hydrogeologic Data at Camp Lejeune Marine Corps Base, North Carolina. USGS. Water-Resources Investigations Report 89-4096.

LeBlond, Richard. 1991. Critical Species List - Camp Lejeune Endangered Species and Special-Interest Communities Survey. Principal Investigator.

SECTION 2.0 TABLES

TABLE 2-1

SUMMARY OF SOIL PHYSICAL PROPERTIES AT SITE 36
 REMEDIAL INVESTIGATION CTO - 0303
 MCB, CAMP LEJEUNE, NORTH CAROLINA

Soil Name	Soil Symbol	USCS Classification	Depth (inches)	Moist Bulk Density (g/cc)	Permeability (cm/s)	Soil Reaction (pH)	Shrink-Swell Potential	Organic Matter (percent)
Baymeade-Urban	BaB	SM, SP-SM	0 - 30	1.60 - 1.75	4.2×10^{-3} - 1.37×10^{-2}	4.5 - 6.5	Low	0.5 - 1.0
Marvyn	MAC	SM	0 - 12	--	1.37×10^{-3} - 4.2×10^{-3}	4.5 - 6.0	Low	<2.0

Source: Soil Survey: Camp Lejeune, North Carolina, U. S. Department of Agriculture - Soil Conservation Service, 1984.

Notes:

- ML = Loam
- SM = Loamy Fine Sand
- SP = Fine Sand
- = Not Estimated
- SC = Fine Sandy Loam

TABLE 2-2

**SUMMARY OF GROUNDWATER AND SURFACE WATER ELEVATIONS
SITE 36, CAMP GEIGER AREA DUMP
REMEDIAL INVESTIGATION, CTO-0303
MCB, CAMP LEJEUNE, NORTH CAROLINA**

Well No.	Casing Elevation	Static Water Levels (TOC)					Static Water Elevations				
		3/23/95	4/10/95	5/9/95	8/18/95	10/15/95	3/23/95	4/10/95	5/9/95	8/18/95	10/15/95
36-GW01	8.93	6.31	6.95	7.31	7.08	NA	2.62	1.98	1.62	1.85	NA
36-GW02	8.80	6.39	7.00	7.20	NA	NA	2.41	1.80	1.60	NA	NA
36-GW03	8.70	6.26	6.95	7.15	6.40	NA	2.44	1.75	1.55	2.30	NA
36-GW04	14.24	5.51	6.64	7.94	8.90	NA	8.73	7.60	6.30	5.34	NA
36-GW05	16.50	6.50	7.49	8.75	9.21	NA	10.00	9.01	7.75	7.29	NA
36-GW06	19.06	6.52	7.53	8.59	9.22	8.11	12.54	11.53	10.47	9.84	10.95
36-GW06DW	19.00	10.26	11.09	12.06	14.92	11.82	8.74	7.91	6.94	4.08	7.18
36-GW07	11.51	2.75	3.76	5.38	5.94	3.49	8.76	7.75	6.13	5.57	8.02
36-GW07DW	11.26	3.05	3.86	4.95	5.70	4.25	8.21	7.40	6.31	5.56	7.01
36-GW08	18.42	9.43	10.70	12.40	12.98	NA	8.99	7.72	6.02	5.44	NA
36-GW09	13.52	8.62	8.85	9.79	9.63	NA	4.90	4.67	3.73	3.89	NA
36-GW10	9.04	6.81	7.38	7.51	7.26	6.62	2.23	1.66	1.53	1.78	2.42
36-GW10IW	9.88	NA	NA	8.35	8.11	7.61	NA	NA	1.53	1.77	2.27
36-GW10DW	9.55	NA	NA	NA	7.46	7.17	NA	NA	NA	2.09	2.38
36-GW11	17.65	14.34	15.69	16.01	15.76	15.27	3.31	1.96	1.64	1.89	2.38
36-GW11DW	18.08	15.30	15.90	16.31	16.18	15.69	2.78	2.18	1.77	1.90	2.39
36-GW12	11.64	NA	NA	10.02	9.72	NA	NA	NA	1.62	1.92	NA
36-GW12IW	12.15	NA	NA	10.54	10.24	NA	NA	NA	1.61	1.91	NA
36-GW13	6.19	NA	NA	4.67	4.42	NA	NA	NA	1.52	1.77	NA
36-GW13IW	5.98	NA	NA	4.45	4.24	NA	NA	NA	1.53	1.74	NA
36-GW14	16.25	NA	NA	12.95	13.24	NA	NA	NA	3.30	3.01	NA
36-SG01	3.18	1.02	NA	1.67	NA	NA	2.16	NA	1.51	NA	NA

Notes:

TOC = Top of Casing
NA = Data Not Available

TABLE 2-3

HYDRAULIC PROPERTIES SUMMARY
 SITE 36, CAMP GEIGER AREA DUMP
 REMEDIAL INVESTIGATION, CTO-0303
 MCB, CAMP LEJEUNE, NORTH CAROLINA

Well ID	Conductivity		Transmissivity		Conductivity		Transmissivity		General Soil Description
	Rising Head (ft/day)	Falling Head (ft/day)	Rising Head (ft ² /day)	Falling Head (ft ² /day)	Rising Head (cm/day)	Falling Head (cm/day)	Rising Head (cm ² /day)	Falling Head (cm ² /day)	
36-GW06	0.6	--	18	--	2.12e-04	--	0.2	--	F sand, trace to some silt
36-GW07	4.2	4.7	126	141	1.48e-03	1.66e-03	1.4	1.5	F sand, some silty clay, w/ med. sand layer
36-GW09	1.3	--	39	--	4.59e-04	--	0.4	--	F sand, some clayey silt w/ silty clay layers
36-GW11	3.4	--	102	--	1.20e-03	--	1.1	--	F sand & clayey silt, w/ med. sand layer
MAXIMUM	4.2	--	126	--	1.48e-03	--	1.4	--	
MINIMUM	0.6	--	18	--	2.12e-04	--	0.2	--	
AVERAGE	2.4	--	71.3	--	8.38e-04	--	0.8	--	
36-GW06DW	6.3	6.1	1,260.0	1,220.0	2.22e-03	2.15e-03	13.6	13.1	Clayey silt & fine sand, some shell frag.
36-GW07DW	7.8	4.3	1,560.0	860.0	2.75e-03	1.52e-03	16.8	9.3	F/M sand, trace to some clayey silt
36-GW11DW	3.0	3.6	600.0	720.0	1.06e-03	1.27e-03	6.5	7.7	Silt & F sand, some shell frag.
MAXIMUM	7.8	6.1	1,560.0	1,220.0	2.75e-03	2.15e-03	16.8	13.1	
MINIMUM	3.0	3.6	600.0	720.0	1.06e-03	1.27e-03	6.5	7.7	
AVERAGE	5.7	4.7	1,140.0	933.3	2.01e-03	1.65e-03	12.3	10.0	

Notes:

"--" Falling head slug test not performed as well level was within screened interval.
 Transmissivity calculation assumed 35 ft thickness for surficial aquifer
 Transmissivity calculation assumed 200 ft thickness for the Castle Hayne aquifer.

TABLE 2-4

**SUMMARY OF POTABLE WATER SUPPLY WELLS
WITHIN A ONE-MILE RADIUS OF SITE 36
REMEDIAL INVESTIGATION CTO-0303
MCB, CAMP LEJEUNE, NORTH CAROLINA**

Supply Well Number	Well Depth (ft)	Screened Interval (ft)	Well Dia. (in)	Approx. Dist. and Dir.	Status of Well	Al (µg/L)	Cu (µg/L)	Fe (µg/L)	Pb (µg/L)	Mn (µg/L)	Zn (µg/L)	Chloride (µg/L)	Fluoride (µg/L)	Nitrite (µg/L)	Sulfate (µg/L)	TDS
TC-502	184	110-184	10	1 mile/ENE	On	340 (5)	ND (3)	ND	ND	ND	ND	160,000	2,200 (6)	20	41,000	840,000 (4)
NC-52	70	25-66	NA	5,000ft/ENE	-1	NA	NA	NA	NA	NA	NA	NA	NA	NA	NA	NA
TC-600	70	48-70	8	5,000ft/ENE	On	290 (5)	ND	9,800 (4)	ND	100 (4)	ND	25,000	300	80	86,000	430,000 (4)
TC-700	76	27.5-76	18	4,600ft/E	-1	270 (5)	ND	9,300 (4)	ND	120 (4)	ND	11,000	20	80	200,000	250,000
TC-901	77	46-56	8	5,000ft/ESE	Off	NA	NA	NA	NA	NA	NA	NA	NA	NA	NA	NA
TC-1251	240	120-140	NA	4,300ft/SE	On	260 (5)	ND	490 (4)	ND	120 (4)	ND	170,000	500	30	6,000	660,000 (4)
TC-1253	250	120-135	NA	1 mile/ESE	Off	330 (5)	ND	40	ND	ND	ND	60,000	1,200	ND	5,800	500,000
MCAS-106	NA (2)	NA	NA	4,000ft/SSW	Off	NA	NA	NA	NA	NA	NA	NA	NA	NA	NA	NA
MCAS-203	173	NA	NA	4,000ft/SSW	On	360 (5)	ND	470 (4)	ND	ND	ND	180,000	1,400	ND	22,000	760,000 (4)
MCAS-131	200	NA	NA	5,000ft/SSW	On	ND	60	540 (4)	7	50	20	110,000	400	50	28,000	550,000 (4)

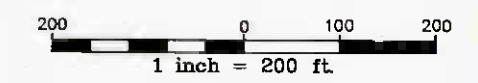
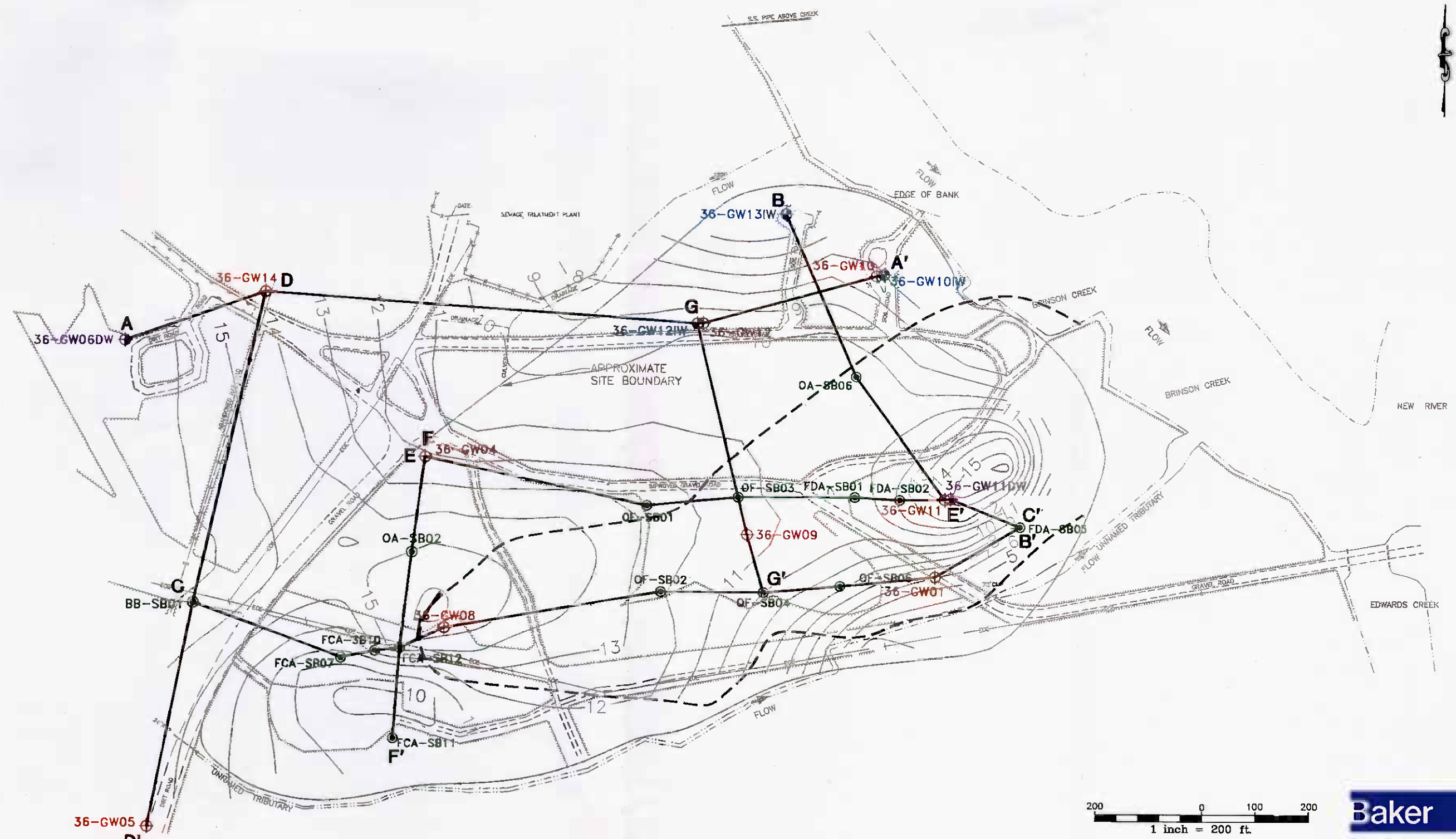
Notes:

The analytical data presented in this table represent detected analytes.

- (1) Status not available
- (2) Not available
- (3) Not detected
- (4) Above USEPA & NC SMCL/Standard (Fe=300 µg/L, Mn=50 µg/L, TDS=500,000 µg/L)
- (5) Above USEPA SMCL (AL=200 µg/L)
- (6) Above NC Standard (Fl=2,000 µg/L)

See Figure 2-6 for well locations.

SECTION 2.0 FIGURES

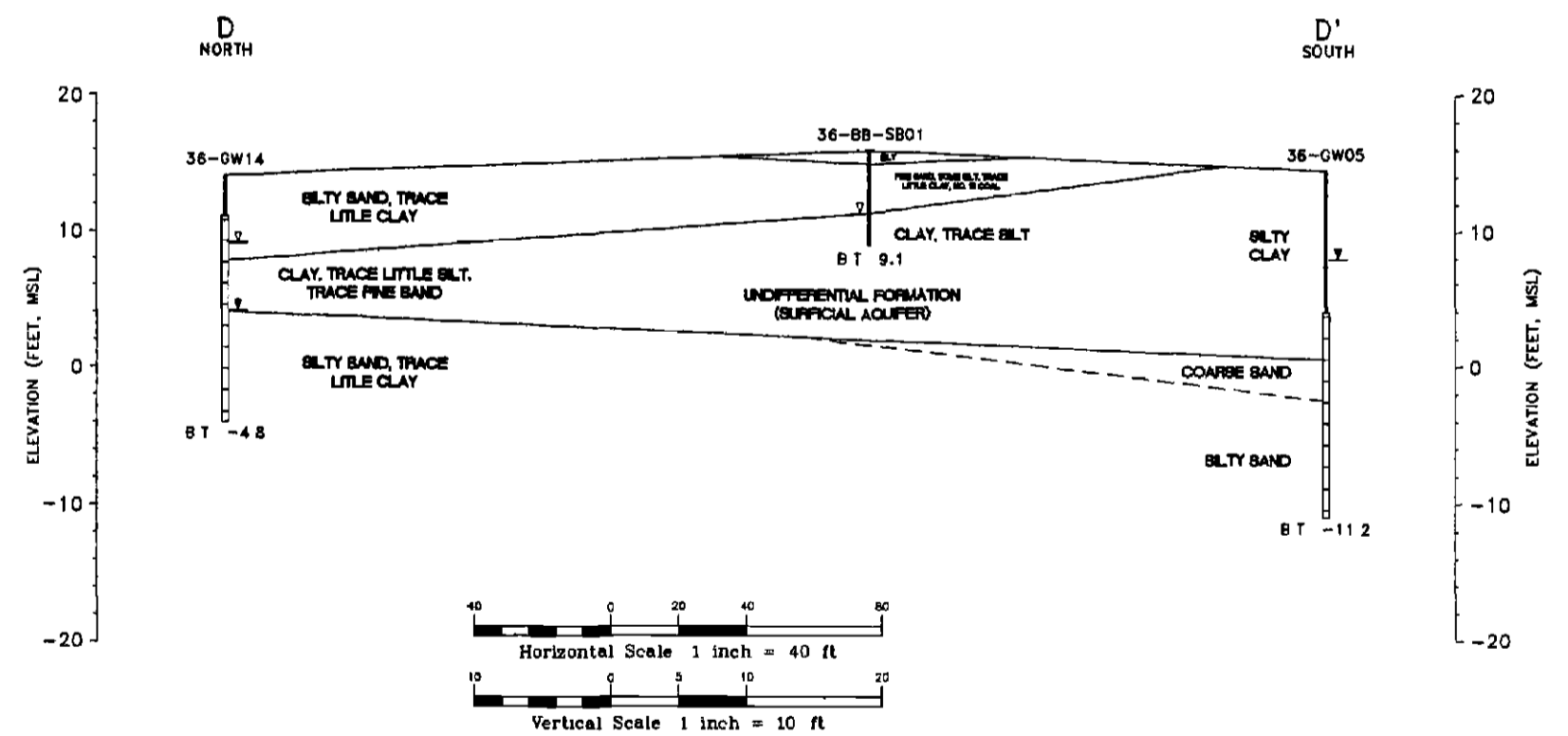
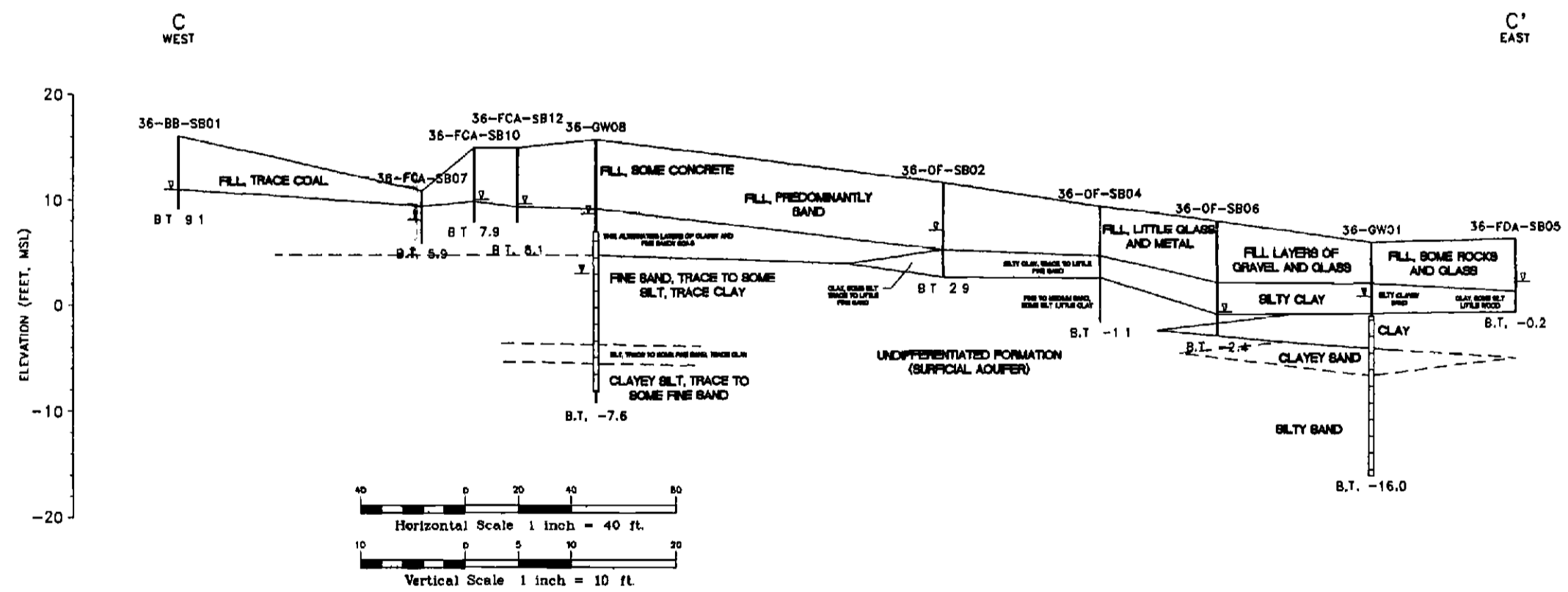
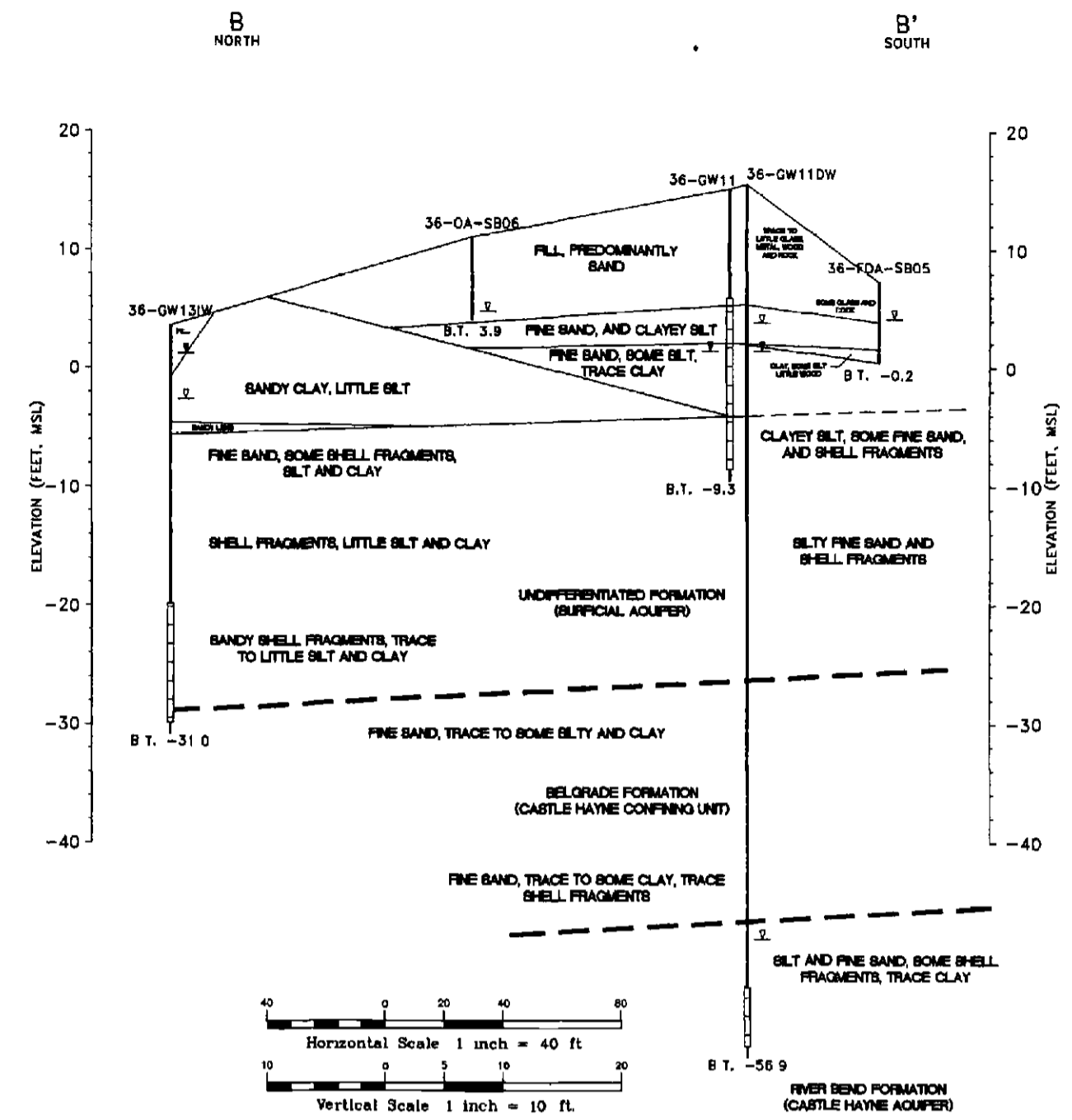
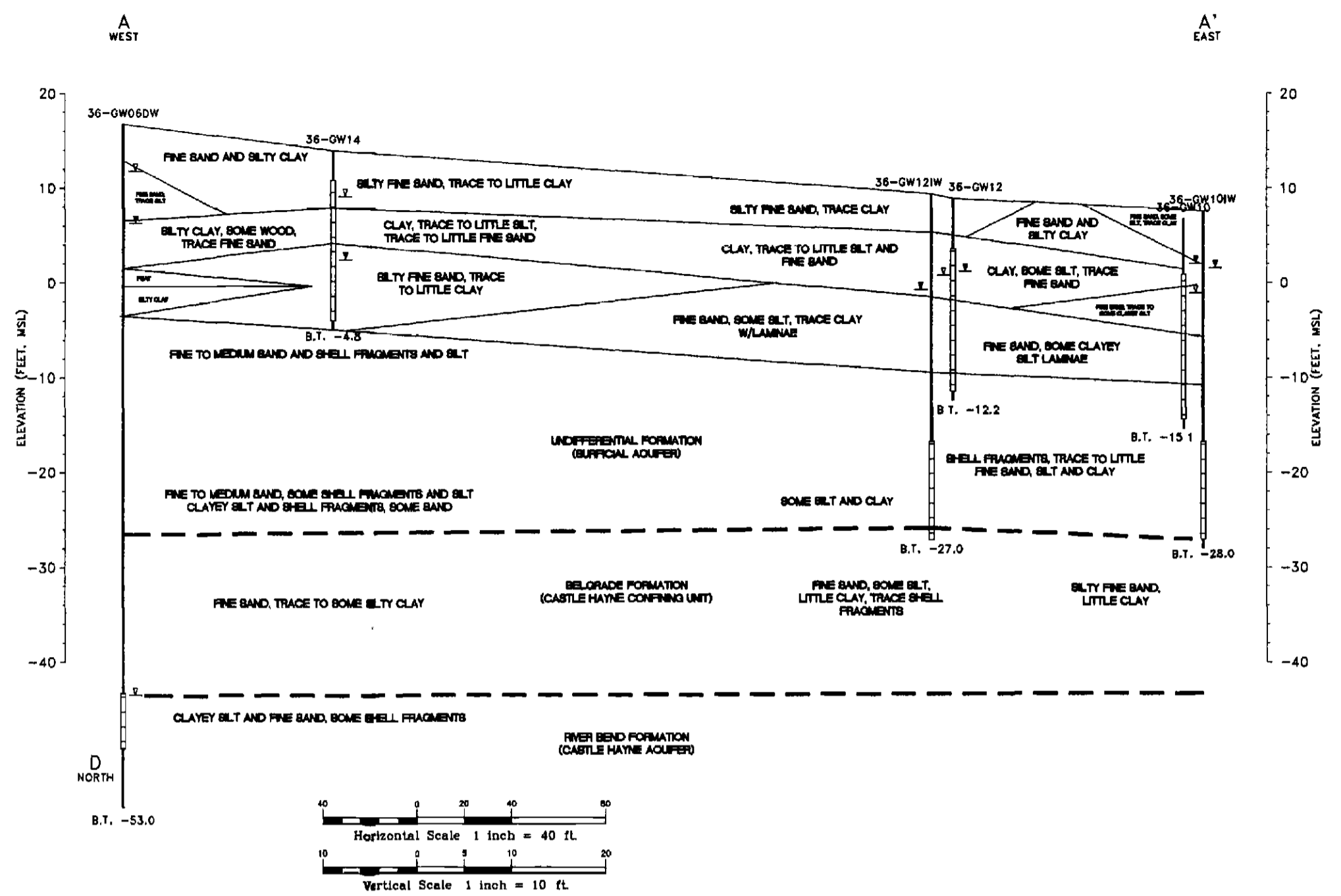


LEGEND

<p>36-GW14 ⊕</p> <p>36-GW12IW ⊕</p> <p>36-GW06DW ⊕</p> <p>OA-SB02 ⊙</p> <p>A—A' —</p> <p>--- ---</p>	<p>SHALLOW MONITORING WELL</p> <p>INTERMEDIATE MONITORING WELL</p> <p>DEEP MONITORING WELL</p> <p>SOIL BORING LOCATION</p> <p>CROSS SECTION TRAVERSE</p> <p>APPROXIMATE LIMIT OF FILL AND/OR DEBRIS, BASED ON BORING LOGS</p>	<p>→ FLOW</p> <p>— EOE</p> <p>* * *</p> <p>///</p> <p>---</p> <p>~</p>	<p>DIRECTION OF SURFACE WATER FLOW</p> <p>OVERHEAD ELECTRIC LINE & UTILITY POLE</p> <p>FENCE</p> <p>ASPHALT ROAD</p> <p>GRAVEL ROAD</p> <p>EDGE OF DRAINAGE DITCH</p> <p>TREE LINE</p>
--	---	--	--

FIGURE 2-1
CROSS SECTION LOCATION AND APPROXIMATE SURFACE ELEVATION CONTOUR MAP
SITE 36, CAMP GEIGER AREA DUMP
REMEDIAL INVESTIGATION, CTO-0303
MARINE CORPS BASE, CAMP LEJEUNE
NORTH CAROLINA

01710401Y



- LEGEND**
- GROUNDWATER ELEVATION (5/9/95)
 - GROUNDWATER ENCOUNTERED DURING DRILLING
 - BORING TERMINATED, ELEVATION MSL
 - WELL SCREEN INTERVAL
 - ESTIMATED
 - PROJECTED
 - FORMATION CONTACT
 - NOT TO SCALE

NOTE:
-THE SOIL BORING INFORMATION IS CONSIDERED TO BE REPRESENTATIVE OF SUBSURFACE CONDITIONS AT THE RESPECTIVE BORING LOCATIONS. SUBSURFACE CONDITIONS INTERPOLATED BETWEEN BORINGS ARE ESTIMATED BASED ON ACCEPTED SOIL ENGINEERING PRINCIPLES AND GEOLOGIC JUDGEMENT.

REVISIONS

DRAWN WJH
REVIEWED MKD
S.O.# 62470-303-0000-05200
CADD# 303012RI

NORTH



REMEDIAL INVESTIGATION - CTO-0303
MARINE CORPS BASE, CAMP LEJEUNE
NORTH CAROLINA

BAKER ENVIRONMENTAL, Inc.
Coraopolis, Pennsylvania

Baker
Baker Environmental, Inc.

GEOLOGIC CROSS SECTIONS A-A',
B-B', C-C' & D-D'
SITE 36, CAMP GEIGER AREA DUMP

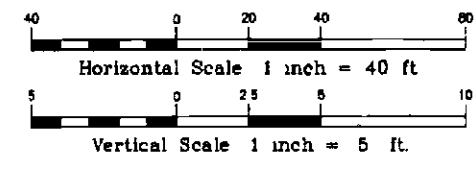
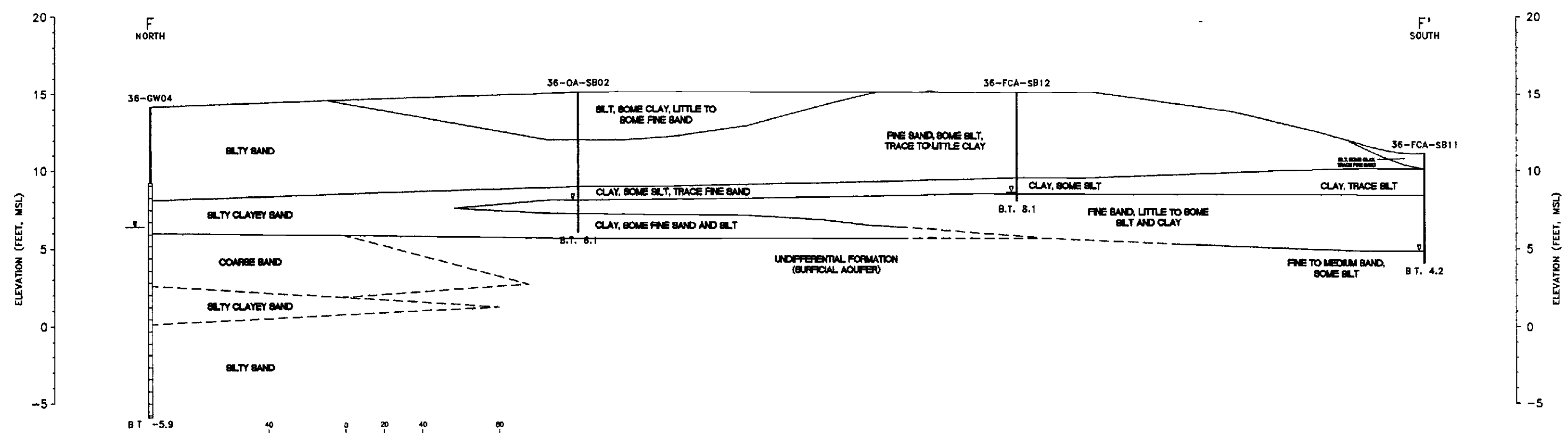
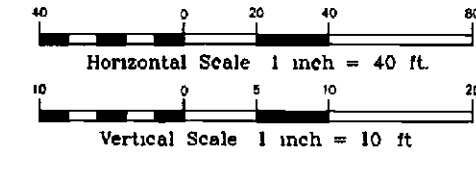
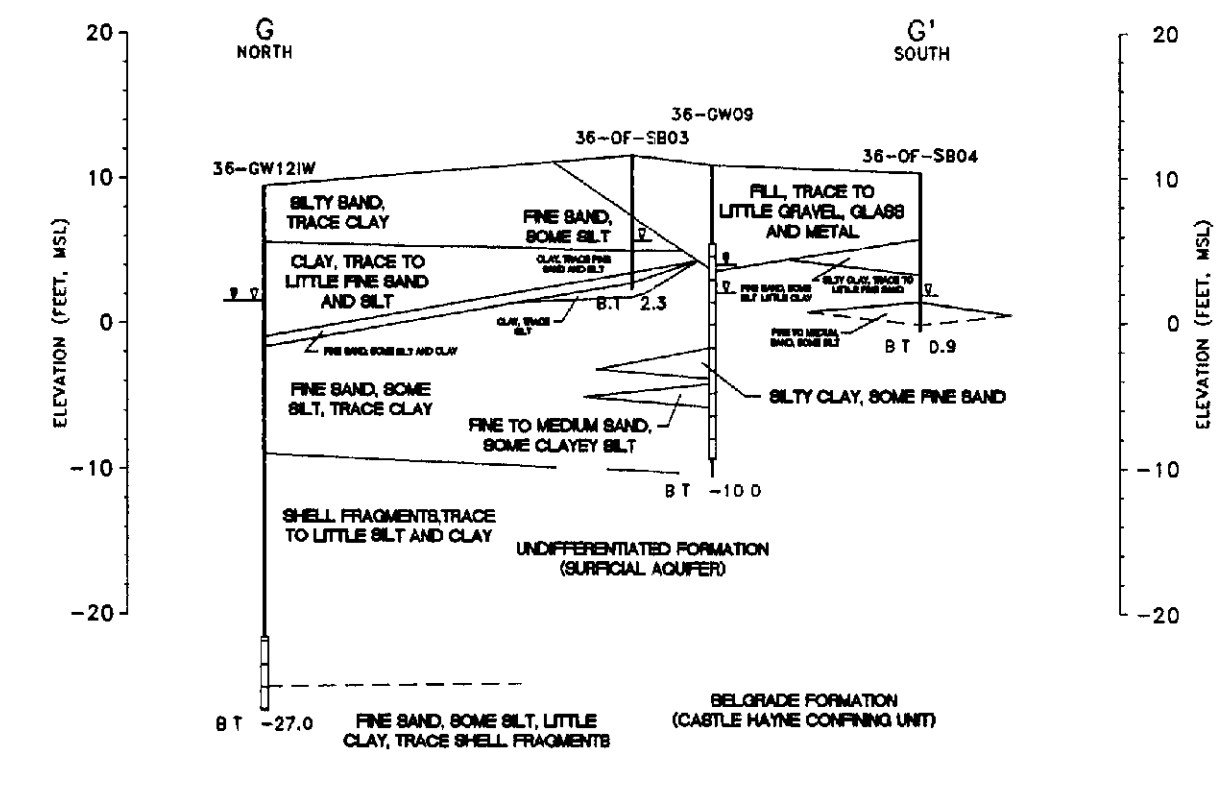
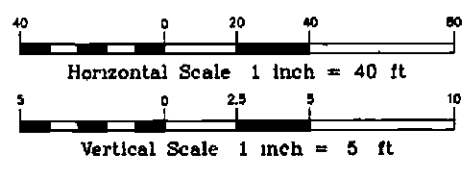
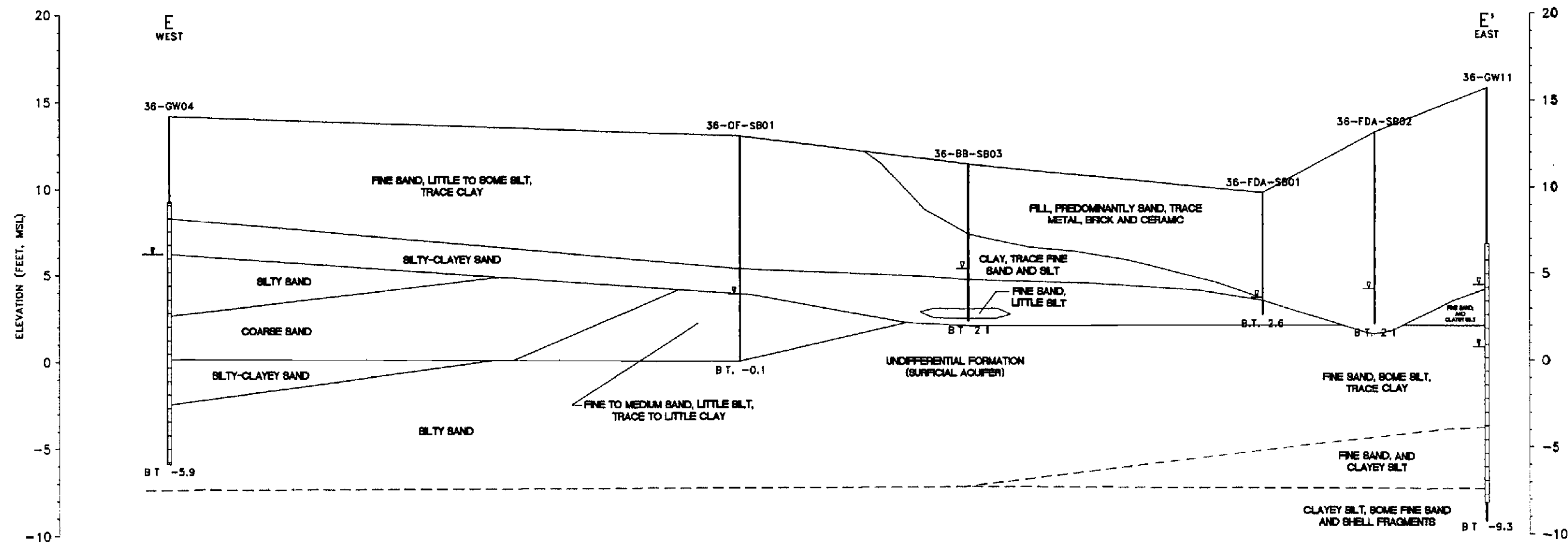
FIGURE No

2-2

SCALE AS SHOWN

DATE JANUARY 1996

01710YB4X



- LEGEND**
- GROUNDWATER ELEVATION (5/9/95)
 - GROUNDWATER ENCOUNTERED DURING DRILLING BORING TERMINATED, ELEVATION MSL
 - BT — WELL SCREEN INTERVAL
 - NOT DETECTED AT METHOD DETECTION LIMITS
 - ESTIMATED
 - - - PROJECTED
 - NTS NOT TO SCALE

NOTE:
 -THE SOIL BORING INFORMATION IS CONSIDERED TO BE REPRESENTATIVE OF SUBSURFACE CONDITIONS AT THE RESPECTIVE BORING LOCATIONS. SUBSURFACE CONDITIONS INTERPOLATED BETWEEN BORINGS ARE ESTIMATED BASED ON ACCEPTED SOIL ENGINEERING PRINCIPLES AND GEOLOGIC JUDGEMENT.

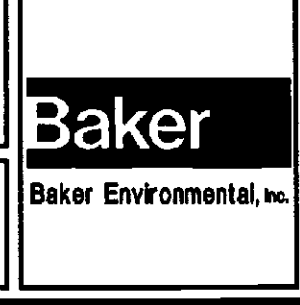
REVISIONS	
DRAWN	WAC
REVIEWED	MKD
S.O.#	62470-303-0000-05200
CAD0#	303011R1

NORTH	

--	--

REMEDIAL INVESTIGATION, CTO-0303
 MARINE CORPS BASE, CAMP LEJEUNE
 NORTH CAROLINA

BAKER ENVIRONMENTAL, Inc.
 Coraopolis, Pennsylvania



GEOLOGIC CROSS SECTIONS E-E', F-F' & G-G'
 SITE 36, CAMP GEIGER AREA DUMP

 SCALE AS SHOWN DATE JANUARY 1996

FIGURE No
2-2
 (cont'd)

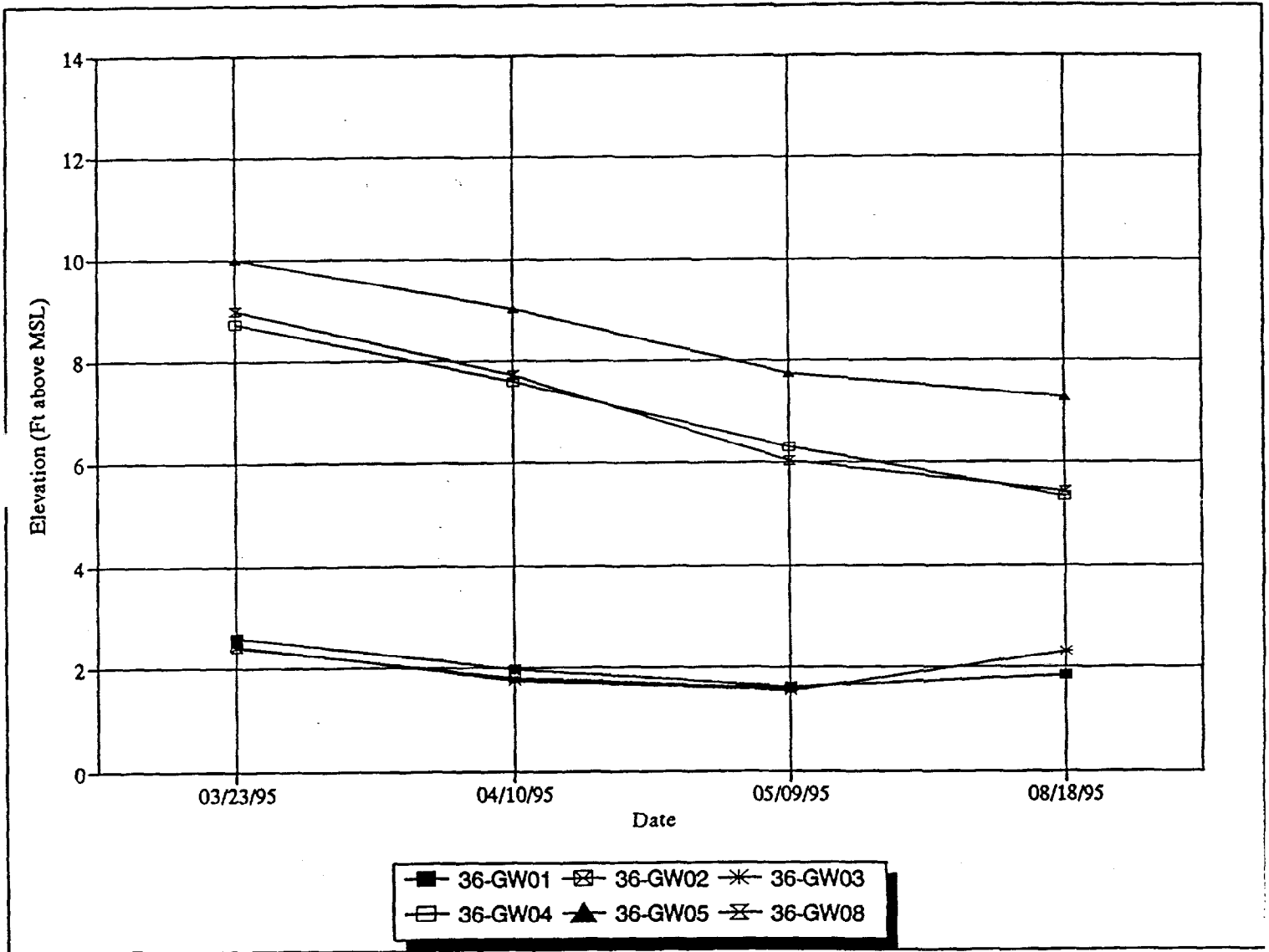


FIGURE 2-3A
GROUNDWATER ELEVATION TRENDS
AT SITE 36
REMEDIAL INVESTIGATION CTO-0303
MCB CAMP LEJEUNE, NORTH CAROLINA

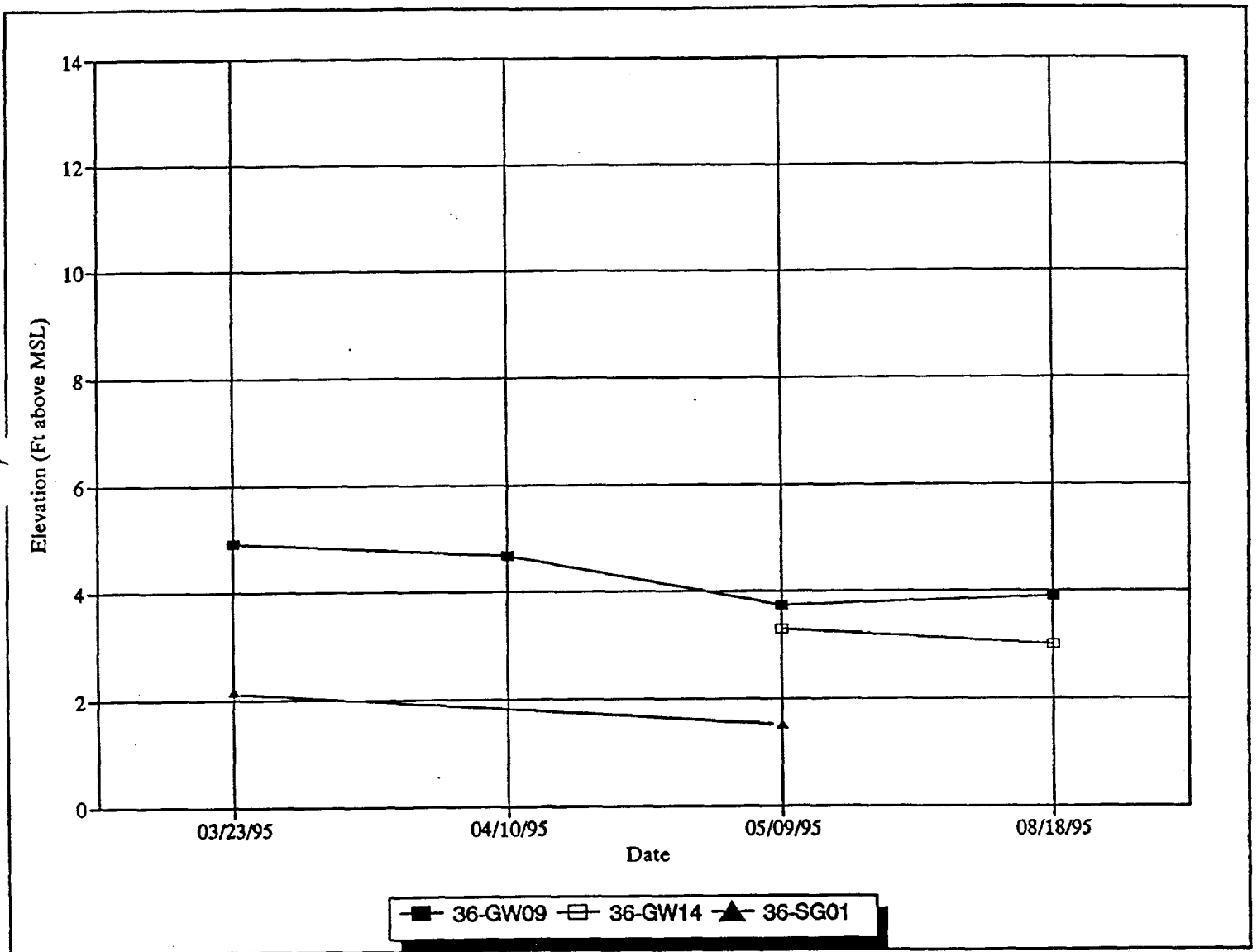


FIGURE 2-3B
GROUNDWATER ELEVATION TRENDS
AT SITE 36
REMEDIAL INVESTIGATION CTO-0303
MCB CAMP LEJEUNE, NORTH CAROLINA

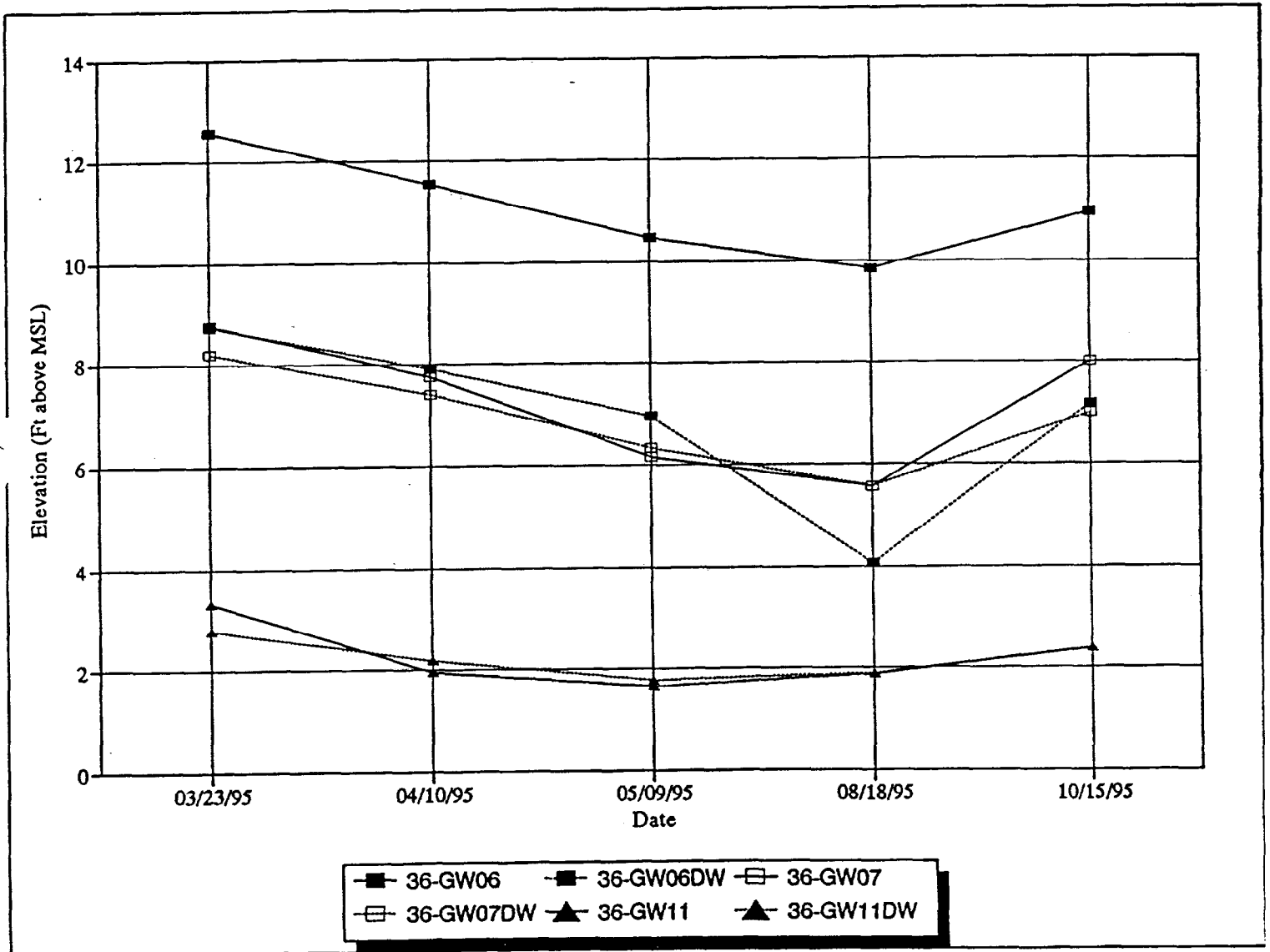


FIGURE 2-3C
 GROUNDWATER ELEVATION TRENDS
 AT SITE 36
 REMEDIAL INVESTIGATION CTO-0303
 MCB CAMP LEJEUNE, NORTH CAROLINA

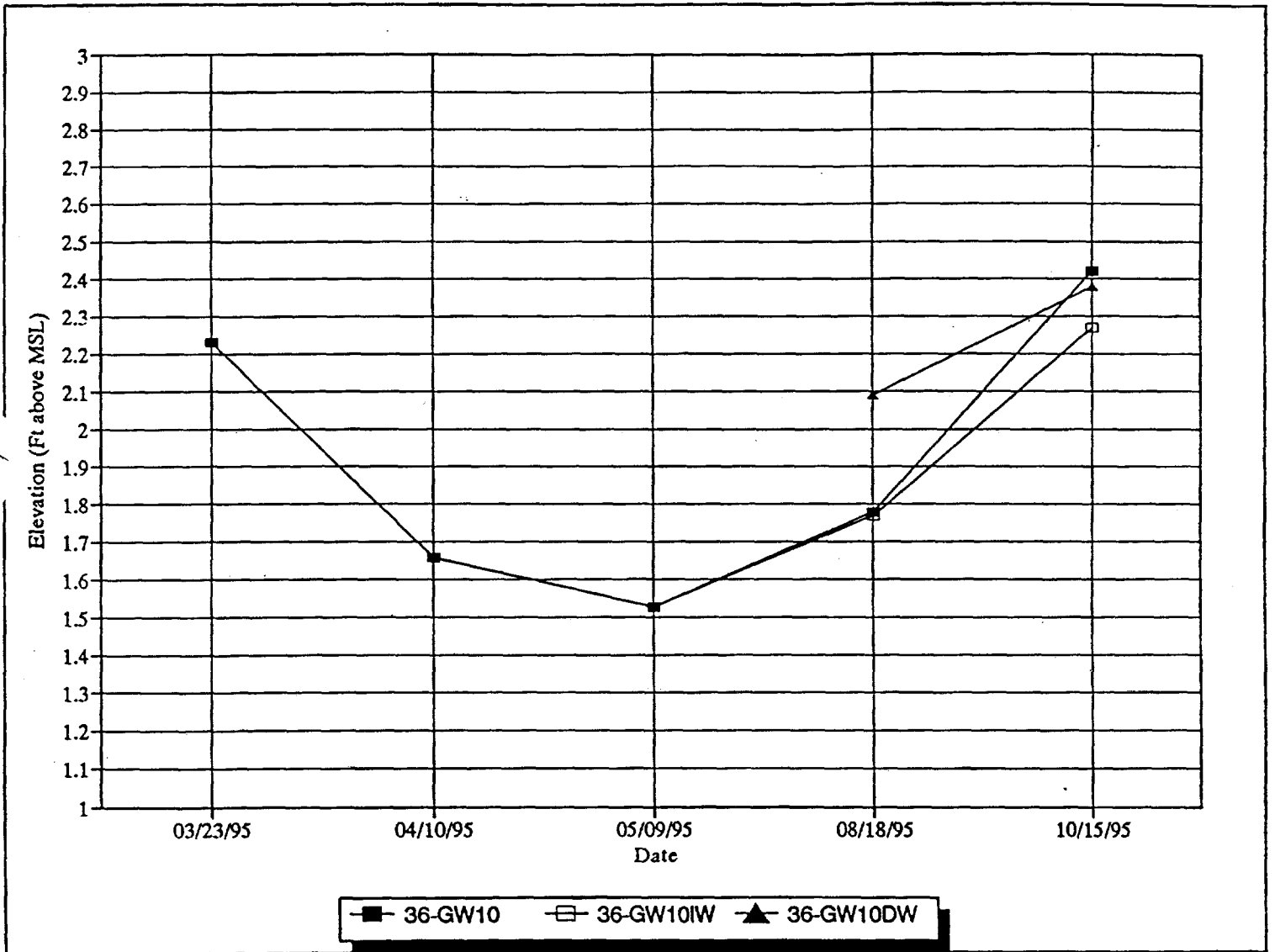


FIGURE 2-3D
GROUNDWATER ELEVATION TRENDS
AT SITE 36
REMEDIAL INVESTIGATION CTO-0303
MCB CAMP LEJEUNE, NORTH CAROLINA

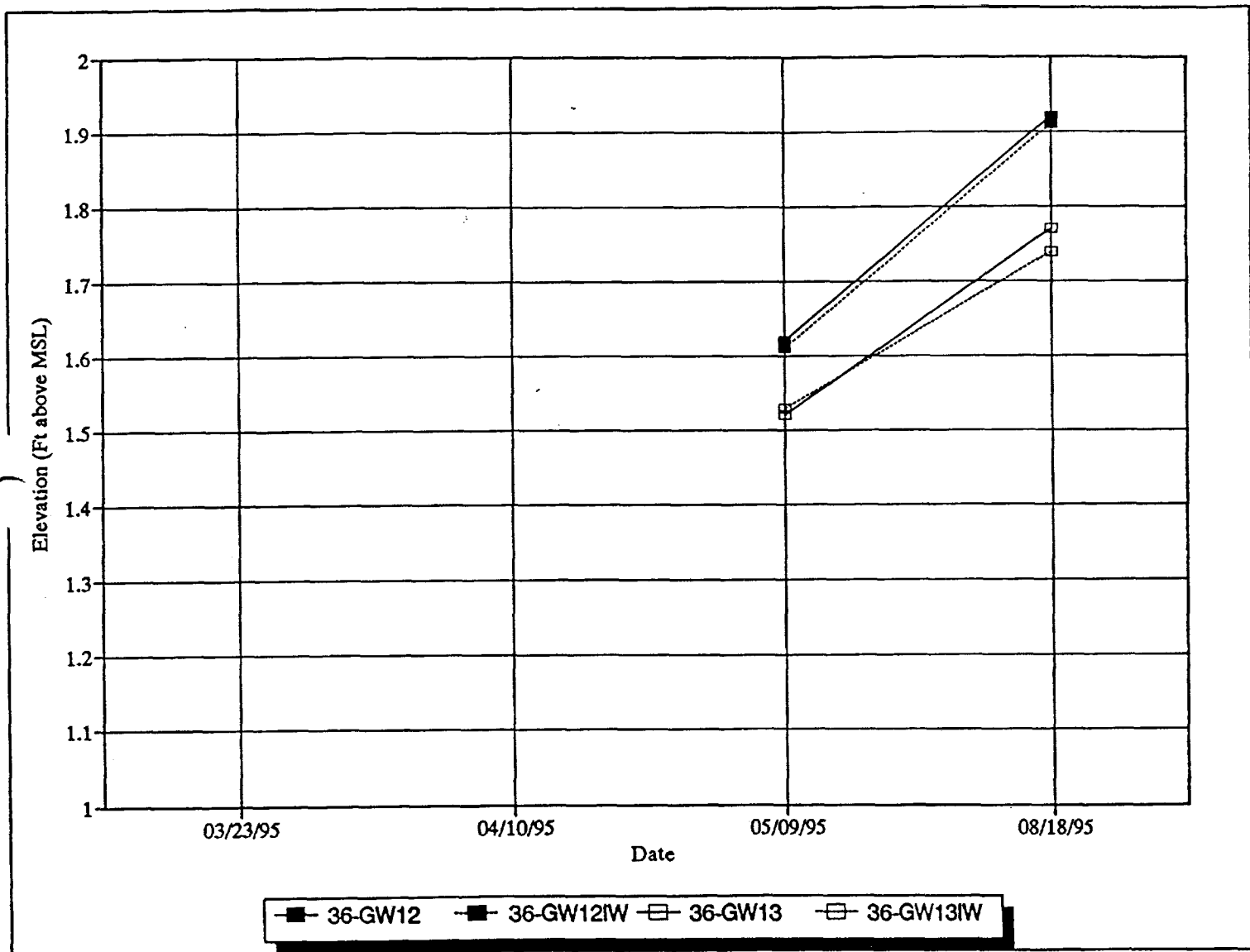
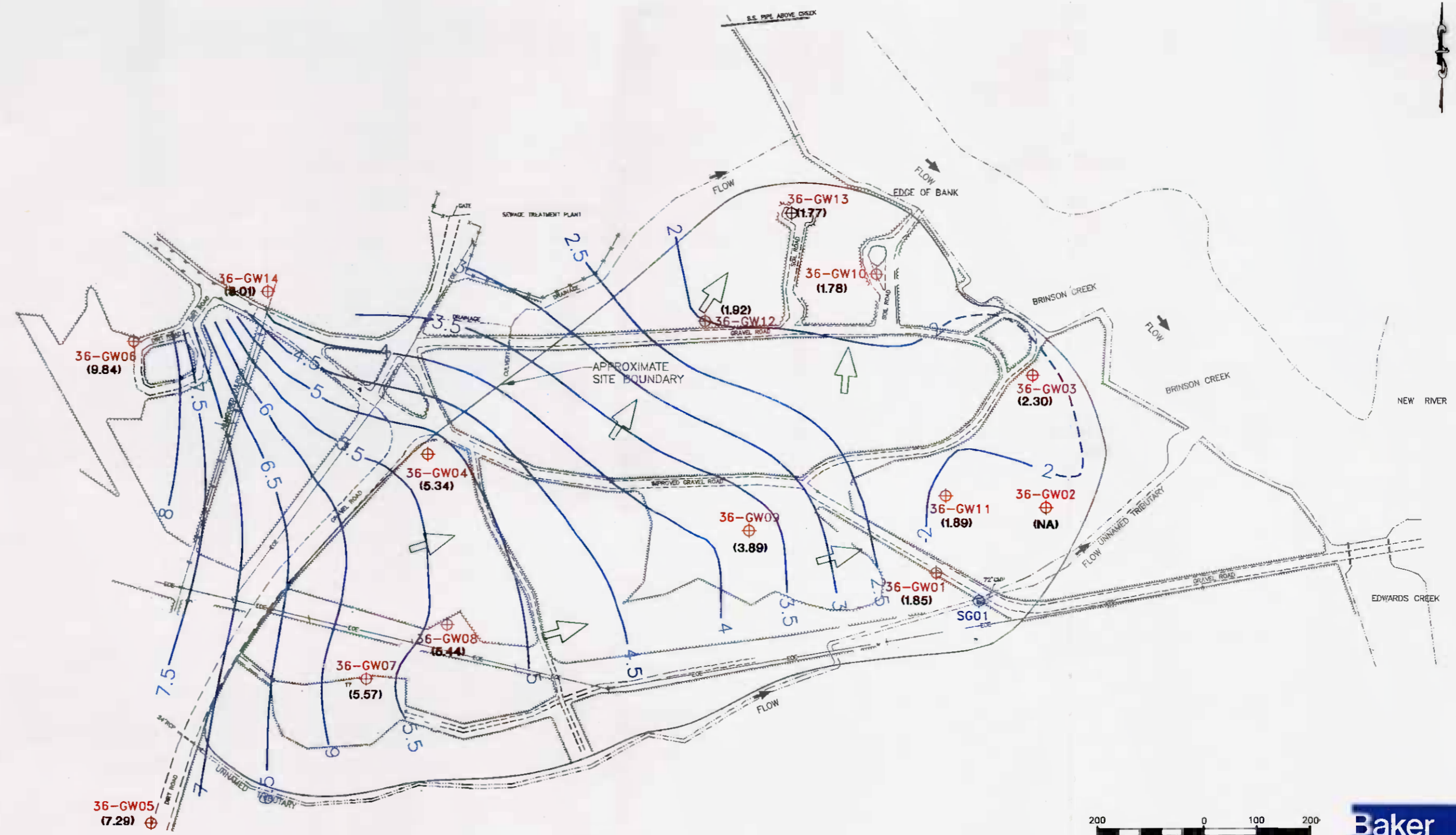


FIGURE 2-3E
 GROUNDWATER ELEVATION TRENDS
 AT SITE 36
 REMEDIAL INVESTIGATION CTO-0303
 MCB CAMP LEJEUNE, NORTH CAROLINA



LEGEND

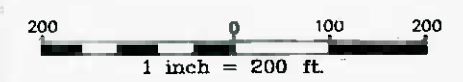
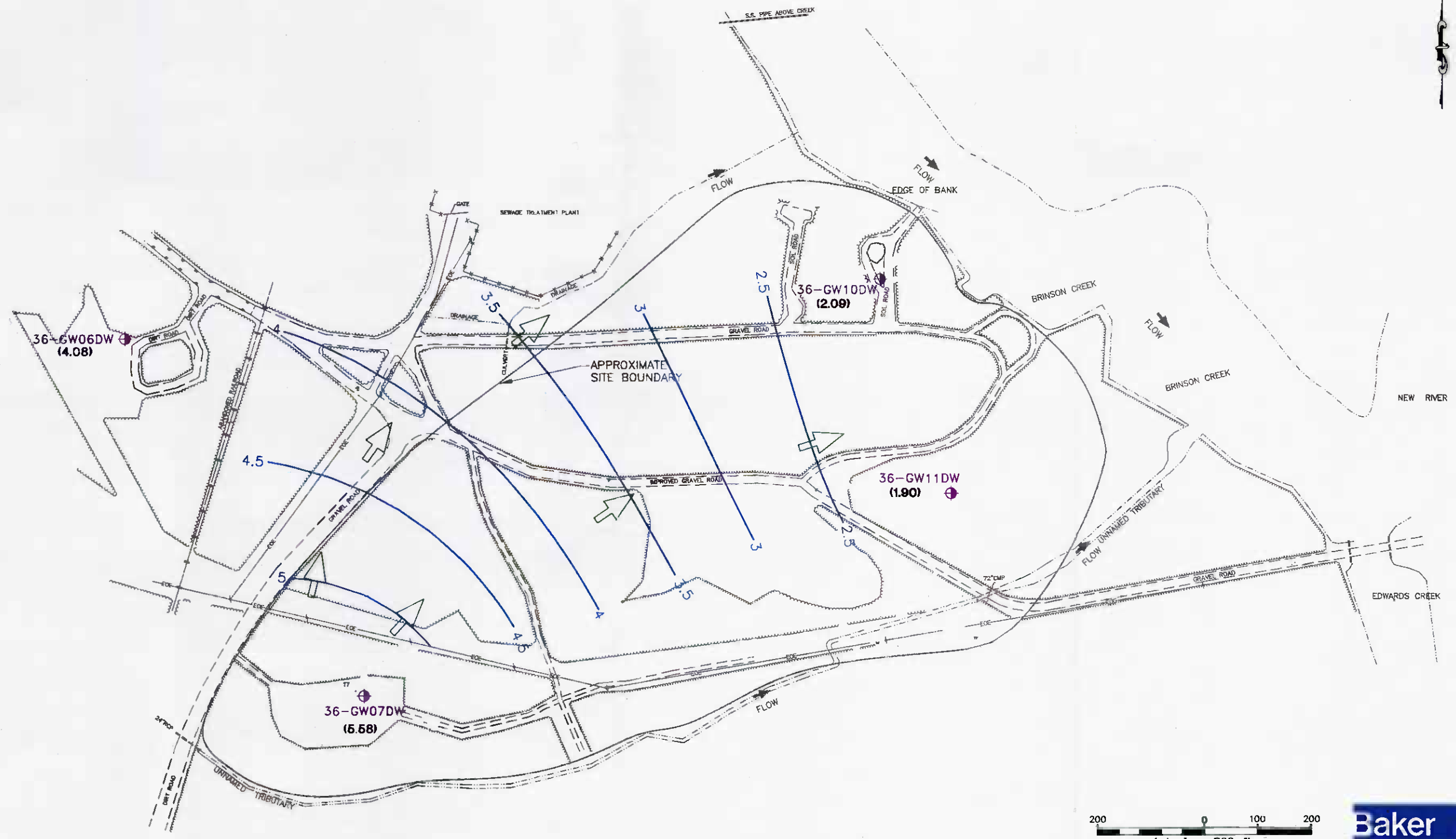
- | | | | |
|---------|-------------------------------|-------|---------------------------------------|
| 36-GW14 | SHALLOW MONITORING WELL | → | DIRECTION OF SURFACE WATER FLOW |
| SG01 | STAFF GAUGE | -EOE- | OVERHEAD ELECTRIC LINE & UTILITY POLE |
| (7.29) | GROUNDWATER ELEVATION | -X-X- | FENCE |
| 7.5 | GROUNDWATER ELEVATION CONTOUR | | ASPHALT ROAD |
| → | GROUNDWATER FLOW DIRECTION | ---- | GRAVEL ROAD |
| | | --- | EDGE OF DRAINAGE DITCH |
| | | ~~~~~ | TREE LINE |

200 0 100 200
1 inch = 200 ft.



FIGURE 2-4
SURFICIAL AQUIFER GROUNDWATER
CONTOUR MAP (AUGUST 1995)
SITE 36, CAMP GEIGER DUMP AREA
REMEDIAL INVESTIGATION, CTO-0303
MARINE CORPS BASE, CAMP LEJEUNE
NORTH CAROLINA

01710YB5Y



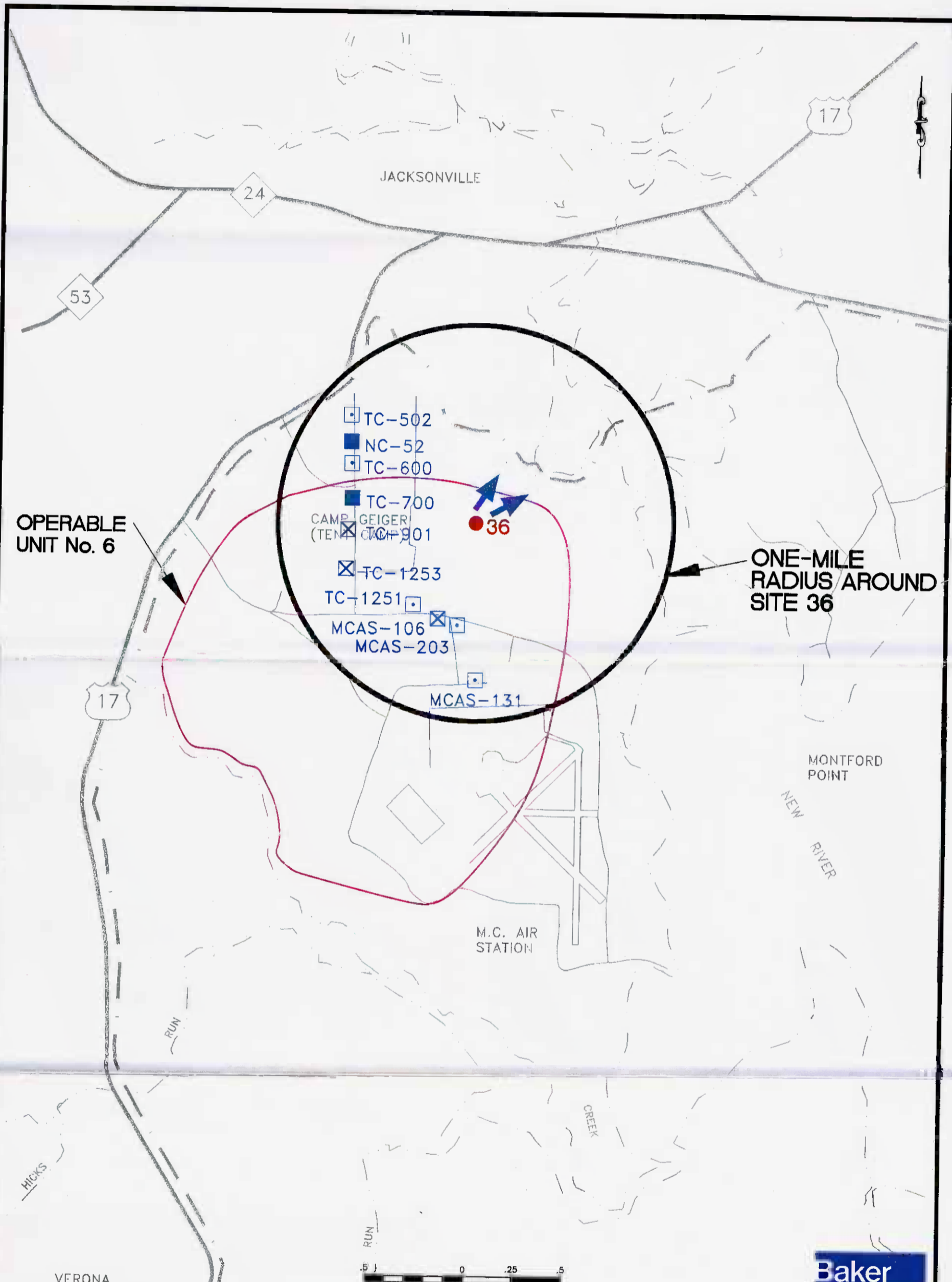
Baker
Baker Environmental, Inc.

- 36-GW06DW DEEP MONITORING WELL
- (4.08) GROUNDWATER ELEVATION
- 5 GROUNDWATER ELEVATION CONTOUR
- GROUNDWATER FLOW DIRECTION

LEGEND

- FLOW
- EOE- OVERHEAD ELECTRIC LINE & UTILITY POLE
- X-X- FENCE
- /// ASPHALT ROAD
- - - - - GRAVEL ROAD
- - - - - EDGE OF DRAINAGE DITCH
- ~ ~ ~ ~ ~ TREE LINE

FIGURE 2-5
CASTLE HAYNE AQUIFER GROUNDWATER
CONTOUR MAP (AUGUST 1995)
SITE 36, CAMP GEIGER DUMP AREA
REMEDIAL INVESTIGATION, CTO-0303
MARINE CORPS BASE, CAMP LEJEUNE
NORTH CAROLINA



OPERABLE
UNIT No. 6

ONE-MILE
RADIUS AROUND
SITE 36



303093RI





VERONA

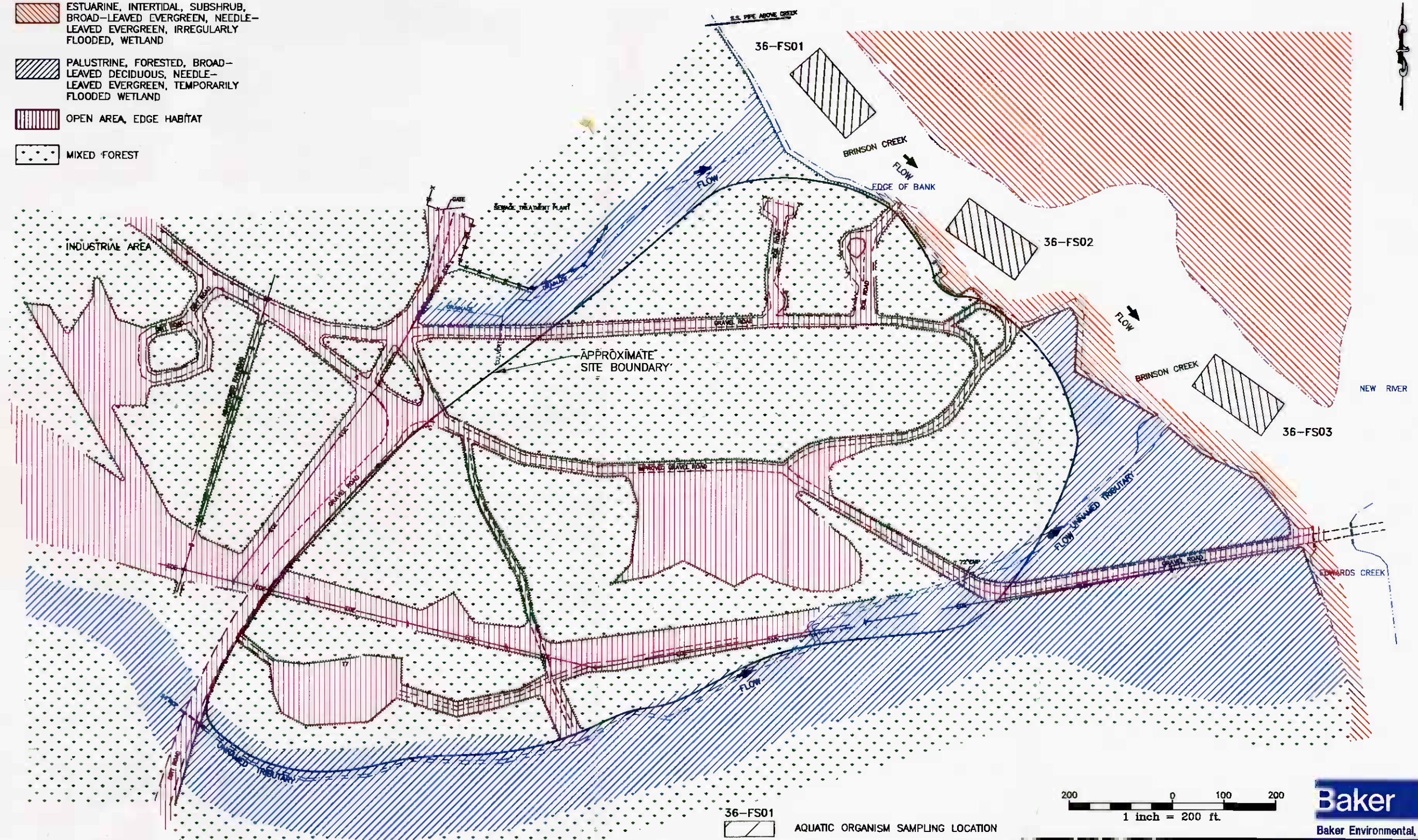
LEGEND



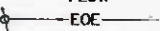

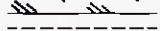


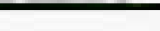


TC-502	□	- WATER SUPPLY WELL IN SERVICE
NC-52	■	- WATER SUPPLY WELL, STATUS NOT AVAILABLE
TC-901	⊗	- WATER SUPPLY WELL OUT OF SERVICE
	➔	- APPROXIMATE DIRECTION OF GROUNDWATER FLOW FROM SITE

SOURCE: LANTDIV, OCT. 1991

FIGURE 2-6
POTABLE WATER SUPPLY WELLS
WITHIN A ONE-MILE RADIUS
SITE 36, CAMP GEIGER AREA DUMP
REMEDIAL INVESTIGATION, CTO-0303
MARINE CORPS BASE, CAMP LEJEUNE
NORTH CAROLINA

-  ESTUARINE, INTERTIDAL, SUBSHRUB, BROAD-LEAVED EVERGREEN, NEEDLE-LEAVED EVERGREEN, IRREGULARLY FLOODED, WETLAND
-  PALUSTRINE, FORESTED, BROAD-LEAVED DECIDUOUS, NEEDLE-LEAVED EVERGREEN, TEMPORARILY FLOODED WETLAND
-  OPEN AREA, EDGE HABITAT
-  MIXED FOREST



-  36-FS01
-  FLOW
-  OVERHEAD ELECTRIC LINE & UTILITY POLE
-  FENCE
-  ASPHALT ROAD
-  GRAVEL ROAD
-  EDGE OF DRAINAGE DITCH OR CREEK
-  TREE LINE
-  AQUATIC ORGANISM SAMPLING LOCATION
-  DIRECTION OF SURFACE WATER FLOW

200 0 100 200
1 inch = 200 ft.

Baker
Baker Environmental, Inc.

FIGURE 2-7
BIOHABITAT MAP
SITE 36, CAMP GEIGER AREA DUMP
REMEDIAL INVESTIGATION, CTO-0303
MARINE CORPS BASE, CAMP LEJEUNE
NORTH CAROLINA

3.0 STUDY AREA INVESTIGATIONS

The field investigation program at OU No. 6, Site 36, was initiated to detect and characterize potential impacts to human health and the environment resulting from past waste management activities. This section discusses the site-specific RI field investigation activities that were conducted to fulfill the objective. The RI field investigation of OU No. 6 commenced on February 20, 1995 and continued through May 10, 1995. An additional deep monitoring well was installed and a second round of groundwater samples were collected from a total of seven wells in July of 1995. A total of five additional soil borings and two sediment samples were collected in October of 1995 to confirm the presence of contamination encountered during the initial investigation. The RI field program at Site 36 consisted of a site survey; a soil investigation, which included sampling and test pit excavations; a groundwater investigation, which included monitoring well installation, sampling, and aquifer testing; a surface water and sediment investigation; an aquatic investigation; and a habitat evaluation. The following sections detail the various investigation activities carried out during the RI.

3.1 Site Survey

The site survey task was performed in two phases: Phase I - Initial Survey of Site Features; and Phase II - Post Investigation Survey of Monitoring Wells and Sampling Locations. Phase I of the survey task was conducted at Site 36 during December of 1994. Based upon information supplied in the Final Site Summary Report (ESE, 1990), surface features within and surrounding the suspected disposal areas were surveyed. The proposed soil boring and monitoring well locations identified in the Final RI/FS Work Plan for OU No. 6 (Baker, 1994), were subsequently located as part of the Phase I survey and marked with wooden stakes. Each sample location was assigned a unique identification number that corresponded to the site and media to be sampled.

Phase II of the site survey task was completed at Site 36 during the week of July 10, 1995. During Phase II, all existing and newly installed monitoring wells were surveyed. Supplemental or relocated soil borings and exploratory test pits completed during the investigation were also surveyed. A number of soil borings were relocated from the locations proposed in the project plans (i.e., moved more than ten feet from their proposed locations) due to the presence of either underground or overhead utilities. In addition, a staff gauge installed in the unnamed tributary that borders the southern portion of the study area was surveyed. Latitude, longitude, and elevation in feet above mean sea level (msl) were recorded for each surveyed point.

3.2 Soil Investigation

The soil investigation performed at Site 36 was intended to:

- Assess the nature and extent of contamination that may have resulted from previous disposal practices or site activities;
- Assess the human health, ecological, and environmental risks associated with exposure to surface and subsurface soils; and
- Characterize the geologic setting of the study area.

The subsections which follow describe soil sample collection procedures, soil boring locations, and the analytical program initiated during the soil investigation at Site 36.

3.2.1 Soil Sampling Procedures

Sampling activities at Site 36 commenced on February 20, 1995. Soil collection was performed using a direct-push (GeoProbe™) sampling system. Borings were advanced by either a truck-mounted rig or by a hand sampler unit. The direct-push sampling system employed a stainless steel cutting shoe and collection tube. A dedicated acetate liner, inserted into the stainless steel collection tube, was used to collect and then extrude soil samples for field and laboratory analyses. All soil sampling activities conducted at Site 36 were performed in Level D personnel protection. Soil cuttings obtained during the soil investigation were collected, handled, and stored according to the procedures outlined in Section 3.8.

Two types of borings were installed during the soil investigation: exploratory test borings (i.e., borings installed for sample collection and description of subsurface units) and borings advanced for the purpose of monitoring well installation. Selected soil samples from each of the two types of borings were submitted for laboratory analysis (see Section 3.2.4). Soils obtained from exploratory borings were collected from the surface (i.e., ground surface to a depth of twelve inches) and at continuous two-foot intervals starting at one foot below ground surface. Continuous sample collection proceeded until the boring was terminated at the approximate depth of the water table which varied at Site 36 from 1 to 15 feet below ground surface. An additional soil sample was collected from below the water table to confirm groundwater depth and ensure that the true water table (i.e., not a perched zone) had been encountered.

Samples were collected for soil description from the ground surface and at continuous two-foot intervals to the water table. Each soil was classified in the field by a geologist using the Unified Soil Classification System (USCS) in accordance with the visual-manual methods described by the American Society for Testing and Materials (ASTM D-2488, 1993). Descriptions were recorded in a field logbook and later transposed onto boring log records. Soil classification included characterization of soil type, grain size, color, moisture content, relative density, plasticity, and other pertinent information such as indications of contamination. Descriptions of site soils are provided on Test Boring Records in Appendix A and on Test Boring and Well Construction Records in Appendix B.

Surface and selected subsurface (i.e., greater than one foot below ground surface) soil samples were retained for laboratory analysis from each of the soil borings. Both surface and subsurface samples were collected to evaluate the nature and extent of potentially impacted soils and to perform the human health risk assessment; however, only the surface soils were employed for the ecological risk assessment. A summary of test boring identification numbers, boring depths, sampling intervals, and laboratory analyses for Site 36 soil samples is provided in Tables 3-1 and 3-2.

Where conditions warranted (i.e., when groundwater was encountered at depths greater than four feet bgs) a minimum of two samples were retained for laboratory analysis from each of the boring locations. In addition, a third sample from the borehole was submitted for analysis if indications of contamination (i.e., elevated photoionization detector (PID) readings or visible contamination) were noted or if the groundwater table was more than ten feet below ground surface. Soil samples retained for analysis were prepared and handled according to USEPA Region IV Standard Operating Procedures (SOPs). Samples collected for volatile organic analysis were extracted with a

stainless-steel spoon from different sections of extruded soil core so that the resulting composite was representative of the entire sampling interval. Precautions were taken not to aerate the sample, minimizing volatilization. Samples retained for other analytical parameters (e.g., semivolatiles, pesticides, PCBs, and inorganics) were thoroughly homogenized prior to being placed in the appropriate laboratory containers.

Following sample collection, each sample retained for laboratory analysis was stored on ice in a cooler. Sample preparation also included documentation of sample number, depth, location, date, time, and analytical parameters in a field logbook. Chain-of-Custody documentation, copies of which are provided in Appendix D, included information such as sample number, date, time of sampling, and sampling personnel, accompanied the samples to the laboratory. Samples were shipped by overnight courier to the laboratory.

3.2.2 Sampling Locations

Representative samples from the study area were collected and submitted for laboratory analysis of target compound list (TCL) organics (i.e., volatiles, semivolatiles, pesticides, and PCBs) and target analyte list (TAL) metals. A total of 69 test borings were sampled during the soil investigation.

Soil samples were collected throughout Site 36 as shown on Figure 3-1. The sampling distribution employed was intended to identify if contamination was present and, if so, to evaluate the vertical and horizontal extent within the study area. The soil sampling program at Site 36 focused on known or suspected disposal areas. Historic aerial photographs from the USEPA's Environmental Photographic Interpretation Center (EPIC), previous investigatory data, and background reports were used to locate potential sampling locations. In addition, evidence of soil disturbance, stressed vegetative cover, and historic aerial photographs were also employed to locate potential soil and exploratory test pit locations.

A total of 66 borings were advanced to assess suspected waste disposal at Site 36; 8 of those borings were utilized for the installation of monitoring wells (refer to Figure 3-1). Nine of the boring locations were advanced within the Former Disposal Area, identified in the IAS report, including one monitoring well test boring. A total of 14 soil borings and one monitoring well test boring were advanced within a cleared area located in the southwestern portion of the study area. Within the northern portion of Site 36, soil samples from six borings and three monitoring well test borings were collected. Six soil borings and one monitoring well test boring were completed in the open field located in the central portion of Site 36. The remaining soil borings were completed at the various locations throughout the site shown on Figure 3-1. Three additional borings, to the west of the study area, were advanced to assess background contaminant concentrations (36-BB-SB01, 36-BB-SB02, and 36-BB-SB03).

Three potentially impacted areas were preliminarily identified through seven-day soil and groundwater sample analyses performed while investigation activities continued elsewhere. Twenty-two of the 66 soil borings mentioned above were added to the investigation as a result of these sample analyses. Additional soil borings were completed at two suspect soil boring locations, 36-OA-SB01 and 36-OF-SB06. A total of nine borings were completed in an area immediately adjacent to 36-OA-SB01, and an additional four borings were placed within 15 feet of 36-OF-SB06. The northern portion of the study area was also determined to be of potential concern and was identified through groundwater analysis from a newly-installed monitoring well. Six soil borings

and three monitoring well test borings were advanced beyond the northern site boundary to provide adequate coverage of the area (refer to Figure 3-1).

In May of 1996 an additional 12 surface samples were collected to further delineate potentially impacted areas immediately adjacent to soil borings 36-OF-SB03, 36-OF-SB04, and 36-OA-SB01. The 12 confirmatory samples were used to confirm the presence of specific organic compounds detected during the initial sampling activities.

3.2.3 Exploratory Test Pits

A total of seven exploratory test pits were completed in conjunction with the soil investigation at Site 36 (refer to Figure 3-1). The exploratory test pit investigation was conducted to assess the nature of any buried material within suspected disposal areas. Excavation logs, provided in Appendix C, describing the contents of each test pit were maintained during field operations. Soil samples from selected exploratory test pits were submitted for laboratory analysis of compounds associated with toxicity characteristic leaching procedure (TCLP) and Resource Conservation and Recovery Act (RCRA) hazardous waste characteristics. Laboratory confirmation analysis of excavated soil was necessary when staining was evident or when organic contamination was indicated through field screening.

Potential test pit locations were identified through visual site inspection and use of a hand-held magnetometer. The visual site inspection sought to identify signs of contamination or waste disposal activity such as soil staining, debris, fill areas, or depressions. In conjunction with the visual site inspection, a magnetometer was employed during the test pit investigation to identify buried metallic objects. Because of the presence and wide distribution of metallic debris throughout the study area, only locations with magnetic detections indicating metallic objects greater than three feet in length were selected for excavation activities.

During the excavation of exploratory test pits by backhoe, Level B personal protective equipment (e.g., supplied air) was employed. In general, test pit dimensions measured 10 to 15 feet in length and 2 to 3 feet in width. The depth of each test pit varied according to the depth of the encountered water table and the total depth of fill material.

3.2.4 Analytical Program

The analytical program initiated during the soil investigation at Site 36 focused on the suspected contaminants of concern, as indicated by information regarding previous disposal practices. Soils collected from the former disposal areas were analyzed for the full TCL organics (i.e., volatile, semivolatile, pesticide, and PCB fractions) and TAL metals as were samples obtained from monitoring well test borings. Additional soil borings and monitoring well test borings, located within the northern portion of the study area, were analyzed for TCL volatiles and TCL semivolatiles only. Five of the nine additional borings placed in the vicinity of 36-OA-SB01 were analyzed for pesticides and PCBs only. The 12 confirmatory surface samples, collected in May of 1996, were analyzed for the corresponding organic compounds identified during the initial field program; the confirmatory results were not validated.

In addition to analyzing for the contaminants of concern, one composite soil sample was collected for analysis of engineering parameters (i.e., particle size, and Atterberg limits). The engineering sample was comprised of individual grab samples collected from the ground surface to the water

table. Soil samples from selected exploratory test pits were submitted for laboratory analysis of the compounds reported as part of TCLP and RCRA hazardous waste characteristics. Laboratory confirmation analysis of excavated soil was requested when staining was evident or when organic contamination was indicated by field screening. The TCLP samples were employed to characterize the nature of the visually contaminated material. Samples were prepared and handled as described in the previous section. Tables 3-1 through 3-3 present a summary of requested soil analyses.

3.2.5 Quality Assurance and Quality Control

Field Quality Assurance/Quality Control (QA/QC) samples were collected during the soil investigation. These samples were obtained to: (1) monitor that decontamination procedures were properly implemented (equipment rinsate samples); (2) evaluate field methodologies (duplicate samples); (3) establish field background conditions (field blanks); and (4) evaluate whether cross-contamination occurred during sampling and shipping (trip blanks). Data Quality Objectives (DQOs) for the QA/QC samples were implemented in accordance with DQO Level IV as defined in the Environmental Compliance Branch SOPs and Quality Assurance Manual, USEPA Region IV (USEPA, 1991). This DQO level is equivalent to the Naval Facilities Engineering Service Center (NFESC) DQO Level D, as specified in the "Sampling and Chemical Analysis Quality Assurance Requirements for the Navy Installation Restoration Programs" document (NEESA, 1988).

Four types of field QA/QC samples were collected and analyzed including: duplicate samples; equipment rinsates samples; field blanks; and trip blanks. The definition of each is listed below (USEPA, 1991):

- Duplicate Sample: Two or more samples collected simultaneously into separate containers from the same source under identical conditions.
- Equipment Blanks: Equipment field blanks (or rinsate blanks) are defined as samples which are obtained by running organic free water over/through sample collection equipment after it has been cleaned. These samples are used to determine if decontamination procedures were adequate. A minimum of one equipment blank per sample media was collected daily, however, only every other blank was analyzed.
- Field Blanks: Organic-free water is taken to the field in sealed containers and poured into the appropriate sample containers at designated locations. This is done to determine if contaminants present in the area may have an affect on the sample integrity.
- Trip Blanks: Trip blanks are prepared prior to the sampling event, placed in the actual sample container, and kept with the investigative samples throughout the sampling event. They are then packaged for shipment with the other samples and sent for analysis. At no time after their preparation are the sample containers to be opened before they return to the laboratory. Field sampling teams utilize volatile organic trip blanks to determine if samples were contaminated during storage and transportation back to the laboratory. If samples are to be shipped, trip blanks are to be provided for each shipment but not necessarily for each cooler (i.e., trip blanks in coolers with samples for VOC analyses only).

Table 3-4 summarizes field QA/QC sample types, sample frequencies, the number of QA/QC samples, and parameters analyzed. Field QA/QC samples were collected at Site 36 according to the procedures outlined in the USEPA Region IV SOPs.

3.2.6 Air Monitoring and Field Screening

Several air monitoring and field screening procedures were implemented during soil investigation activities at Site 36. Ambient air monitoring for volatile contaminants was performed at each open borehole using a PID. During exploratory test pit operations, the ambient air was monitored for volatile organics with both a PID and a flame ionization detector (FID).

Soil samples were field screened for volatile organic contaminants with a PID. Excavated soil from exploratory test pits was screened with both PID and FID. Measurements obtained in the field were recorded in a logbook and later transposed onto the Test Boring Records and the Well Construction Records (provided in Appendices A and B). Prior to daily monitoring, the field instruments were calibrated and documentation was recorded in a field logbook and on appropriate calibration forms.

3.3 Groundwater Investigation

The groundwater investigation performed at Site 36 was intended to:

- Assess the nature and extent of contamination that may have resulted from previous disposal practices or site activities;
- Assess human health and environmental risks associated with exposure to groundwater; and
- Characterize the hydrogeologic setting of the study area.

The subsections which follow describe well installation procedures, sample collection procedures, the analytical program, and hydraulic conductivity test procedures employed during the groundwater investigation at Site 36.

3.3.1 Monitoring Well Installation

Nine shallow and three intermediate Type II monitoring wells (i.e., wells installed without casing to seal off a semi-confining or confining layer) were installed at Site 36 from February through April of 1995. Locations of the newly installed monitoring wells are depicted on Figure 3-2. The nine shallow and three intermediate monitoring wells were situated spatially to intercept potentially impacted groundwater from the suspected disposal areas, and to characterize the nature and horizontal extent of possible contamination. The existing and newly-installed monitoring wells were also used to evaluate groundwater flow patterns within the upper and lower portions of the surficial aquifer. In addition to the shallow and intermediate wells, four deep Type III monitoring wells (i.e., wells installed with casing to seal off a confining or semi-confining layer) were installed during February, March, and July of 1995, at Site 36 (refer to Figure 3-2). The four deep wells were installed to assess the nature and vertical extent of contamination and to evaluate the flow pattern of the deeper aquifer (i.e., the Castle Hayne aquifer). Placement of the newly installed monitoring wells was based on review of historical aerial photographs, previous investigations, and analytical data generated during the initial phase of the RI (i.e., seven-day soil and groundwater data).

A total of seven monitoring wells were added to the investigation of Site 36 beyond the initial work scope, based upon results of seven-day groundwater analyses. As previously mentioned, an area beyond what was thought to be the northern boundary of the study area was identified during the preliminary evaluation of laboratory analytical results from 36-GW10 (refer to Figure 3-2). Three shallow, three intermediate, and one deep monitoring well was added to the northern portion of the study area as a result of these analyses.

Shallow monitoring wells were installed after the pilot test boring was advanced to the desired depth. Each borehole was reamed with 6-1/4-inch internal diameter (ID) hollow stem augers prior to shallow well installation. Shallow well depths ranged from 18 to 24 feet below ground surface and deep well depths ranged from 63 to 72 feet below ground surface. In general, the shallow wells were installed approximately 10 feet below the water table encountered during the pilot hole test boring. Shallow monitoring wells were installed with screened intervals bisecting the water table sufficiently to compensate for seasonal variations in the water table which is known to fluctuate from two to four feet. Well construction details are summarized in Table 3-5, and well construction diagrams are shown on the Test Boring and Well Construction Records provided in Appendix B.

The intermediate and deep monitoring wells were installed upon completion of pilot hole test borings which were advanced using mud and wash rotary drilling methods. Each borehole was drilled with a 6-inch wing bit prior to well installation. The three intermediate wells were screened at intervals from approximately 25 to 35 feet below ground surface, resting upon semi-confining, less permeable, geologic material (i.e., a combination of sand, silt, and clay) at the bottom of the surficial aquifer. The four deep monitoring wells were screened at intervals just below the semi-confining unit in the upper portion of the Castle Hayne aquifer. Screened intervals for the deep wells ranged from approximately 62 to 72 feet below ground surface (refer to Table 3-5 and Appendix B for well construction details).

All of the permanent monitoring wells were constructed of two-inch nominal diameter, Schedule 40, flush-joint and threaded, polyvinyl chloride (PVC) casing. Justification for the use of PVC casing is provided in Appendix B of the Field Sampling and Analysis Plan for Operable Unit No. 6 (Baker, 1994). Each shallow well utilized a 15-foot screened interval comprised of a 10- and 5-foot long No. 10 (i.e., 0.01 inch) slotted screen sections. Intermediate and deep monitoring wells were constructed with ten-foot and five-foot No. 10 slotted screen sections, respectively. A fine-grained sand pack (i.e., No. 1 silica sand), extending approximately 2 feet above the top of the screen, was placed in the annulus between the screen and the borehole wall from inside the augers during shallow well installation. The sand pack was poured manually down the borehole during deep well installation and checked continuously with a weighted tape measure to determine sand pack depth. A two- to three-foot sodium bentonite pellet seal was placed above the sand pack by dropping pellets down the borehole. The bentonite pellets were hydrated with potable water after placement. A sodium bentonite slurry was used to backfill the annular space from above the bentonite pellet seal to the bottom of the steel casing (i.e., above the semi-confining unit). The remaining annular space was backfilled with a mixture of Portland cement and five percent powdered bentonite. During construction of the Type III deep wells, Portland cement was used to secure the six-inch steel casing to the uppermost portion of the semi-confining layer. A five-foot by five-foot concrete pad was placed around the protective well casing and four protective bollard posts were installed around the corners of the concrete pad. A four-inch protective well casing with locking cover was placed over the well and set into the cement. Well tags, which provide construction information, were installed at the top of each well. Typical shallow and intermediate Type II well construction details are

shown on Figures 3-3 and 3-4. Figure 3-5 depicts the construction details of a typical Type III deep monitoring well.

Two temporary wells were employed to assess groundwater conditions in a low-lying area adjacent to the southern boundary and unnamed tributary which was not suited for permanent well construction. The temporary wells were constructed of one-inch nominal diameter, Schedule 40, flush-joint and threaded PVC casing placed in an open borehole. A filter sock was used to filter fine materials from the surrounding formation. Immediately following sample acquisition the two temporary wells were removed.

3.3.2 Monitoring Well Development

Following well construction and curing of the bentonite seal and cement grout, each newly installed monitoring well was developed to remove fine-grained sediment from the screen/sandpack and to establish interconnection between the well and the surrounding formation. The shallow wells were developed by a combination of surging and pumping. The intermediate and deep wells were developed using a forced air system (with filter) and "lifting" the water out of the well. Typically, 20 to 40 gallons of water were evacuated from the shallow wells, followed by 10 minutes of surging, then continued pumping. Three to five borehole volumes were evacuated from each deep well, approximately 100 to 250 gallons. Groundwater recovered during well development was temporarily stored in drums, then transferred into on-site storage tanks (refer to Section 3.8). Pumping hoses, constructed of flexible PVC, were used once and discarded to minimize the potential for cross contamination.

Three to five borehole volumes were removed from each well, where conditions permitted, until the groundwater was essentially sediment-free. Measurements of pH, specific conductance, and temperature were recorded after each volume was removed to assist in assessing well stabilization. Additionally, periodic flow and volume measurements were also recorded during development to evaluate flow rates of the shallow water-bearing zone. Well Development Records that summarize this information are provided in Appendix E.

3.3.3 Water Level Measurements

Static water level measurements were collected after all well development activities had been completed. Measurements were recorded from top-of-casing (TOC) reference points marked on the PVC casing at each existing and newly-installed well. Water level measurements were collected on March 23, April 10, May 9, and August 18, 1995. Groundwater measurements were recorded using an electric measuring tape which were recorded to the nearest 0.01 foot. Water level data from site monitoring wells and staff gauges were collected within a three-hour period. A summary of water level measurements is provided in Table 3-6.

3.3.4 Aquifer Testing

Well-head tests (i.e., slug tests) were performed on selected wells at Site 36 as part of the groundwater investigation. Aquifer testing results are provided in Appendix N. Both falling- and rising-head tests were performed to approximate individual well characteristics and to provide generalized information regarding aquifer parameters within the study area.

3.3.5 Sampling Locations

Round one groundwater samples were collected from five existing shallow wells (36-GW01 through 36-GW05), the six newly installed shallow wells (36-GW06 through 36-GW11), two temporary wells (36-TW01 and 36-TW02), and the three newly installed deep wells (36-GW06DW, 36-GW07DW, and 36-GW11DW) at Site 36. The locations of the newly installed, temporary, and existing monitoring wells are shown on Figure 3-2.

The first groundwater sampling round, which included sample collection from existing and newly installed wells, was conducted at Site 36 in March of 1995. Based upon the analytical results generated during the March sampling round, an additional three shallow (36-GW12, 36-GW13, and 36-GW14) and three intermediate monitoring wells (36-GW10IW, 36-GW12IW, and 36-GW13IW) were installed in April and sampled in May of 1995.

A second round of groundwater sampling was performed in July of 1995 that included the sampling of one newly installed deep monitoring well (36-GW10DW) and the resampling of the supplemental monitoring wells installed in April. The second round was conducted to confirm the presence of VOCs detected in samples retained from the northern portion of the study area.

3.3.6 Sampling Procedures

Groundwater samples were collected to assess whether contamination was present in the shallow and deep aquifers resulting from previous site disposal practices at Site 36. Based upon previous investigative results and historical records, the contaminants of concern were volatiles, polynuclear aromatic hydrocarbons (PAHs), and metals. Accordingly, the sampling program initiated at Site 36 focused on these contaminants.

Prior to groundwater purging, a water level measurement from each well was obtained according to procedures outlined in Section 3.3.3. The total well depth was also recorded from each well to the nearest 0.1 foot using a decontaminated steel tape. Water level and well depth measurements were used to calculate the volume of water in each well and the volume of water necessary to purge the well.

A minimum of three to five well volumes were purged from each well prior to sampling. Measurements of pH, specific conductance, temperature, and turbidity were taken after each well volume was purged to ensure that the groundwater characteristics had stabilized before sampling. These measurements were recorded in a field logbook and are provided in Tables 3-7 and 3-8. Purge water was contained and handled as described in Section 3.8.

During both groundwater sampling events, a low flow well purging and sampling technique was employed. The sampling methodology was developed in response to conversations with USEPA Region IV personnel in Athens, Georgia. A peristaltic pump (GeoPump), with the intake set two to three feet into the static water column, was used to purge each of the wells. While purging groundwater from each of the monitoring wells, a flow rate of less than 0.25 gpm was maintained. Samples collected for both organic and metal analyses were obtained directly from the pump discharge. The Teflon™ tubing was decontaminated with a Liquinox soap solution and thoroughly rinsed with deionized water (refer to Section 3.7 for decontamination procedures). A dedicated one-foot section of silicon pump-head tubing was used during purge and sampling activities at each well.

Rinsate blanks were collected from the Teflon™ and silicon tubing to verify that proper decontamination procedures were being followed.

Preparation of groundwater samples incorporated procedures similar to those described for soil samples. Sample information, including well number, sample identification, time and date of sample collection, samplers, analytical parameters, and required laboratory turnaround time, was recorded in a field logbook and on the sample labels. Chain-of-custody documentation (provided in Appendix D) accompanied the samples to the laboratory.

3.3.7 Analytical Program

Groundwater samples from five existing shallow wells, six newly installed shallow wells, three newly installed deep wells, and two temporary wells were analyzed as part of the first sampling round. During the first round, samples were analyzed for full TCL organics, TAL total metals, total suspended solids (TSS), and total dissolved solids (TDS). During a supplemental sampling round in May 1995, groundwater samples from three additional shallow and three additional intermediate wells were analyzed for TCL volatiles, TAL total metals, TSS, and TDS. During each of the sampling rounds, a limited number of samples were also analyzed for TAL dissolved metals.

Groundwater samples from three shallow wells, three intermediate wells, and a newly installed deep well were again analyzed during a second sampling round. The second sampling round focused on the presence of VOCs that were initially detected in the northern portion of the study area. Tables 3-9 and 3-10 provide summaries of groundwater samples submitted for laboratory analysis during the first and second sampling rounds. The groundwater samples were analyzed using Contract Laboratory Program (CLP) protocols and Level IV data quality.

3.3.8 Quality Assurance and Quality Control

Field QA/QC samples were also submitted for analyses during the groundwater investigation. These samples included trip blanks, equipment rinsates, and duplicates. Equipment rinsates were collected from the peristaltic pump and Teflon™ tubing after decontamination was completed and prior to reuse. Section 3.2.5 provides a summary of QA/QC samples collected during the investigation. Table 3-11 summarizes the QA/QC sampling program employed for the groundwater investigation conducted at Site 36.

3.3.9 Field Screening and Air Monitoring

Air monitoring and field screening procedures for volatile organic vapors implemented at Site 36 included the screening of well heads and the purged groundwater with a PID. Measurements obtained in the field were recorded in a field logbook. Prior to daily monitoring, the field instruments were calibrated and documentation was recorded in a field logbook and on calibration forms.

3.4 Surface Water and Sediment Investigations

An overview of the surface water and sediment investigations conducted at Site 36 is provided in this section. Surface water and sediment samples were collected at Site 36 during April and May of 1994, during RI activities at OU No. 10 (Site 35). A supplemental round of surface water samples were collected in April of 1995 and submitted for dissolved metal laboratory analyses. Two

additional sediment samples were collected in October of 1995 and submitted for analysis of TAL metals only. The subsections which follow describe the surface water and sediment sampling locations, sampling procedures, analytical program, and quality assurance and quality control program for Site 36.

3.4.1 Sampling Locations

A total of 7 surface water and 15 sediment samples were collected at Site 36 with most sampling stations yielding one surface water and two sediment samples. Three of the sampling stations were located in Brinson Creek and four were located in an unnamed tributary to Brinson Creek. Based upon results of the initial investigation, two additional sediment samples were collected to confirm the presence of metal concentrations at location 36-SD06. Figure 3-6 depicts the locations of the surface water and sediment sampling locations. Surface water samples were assigned the designation "SW" and "SD" was specified for identification of sediment samples.

3.4.2 Sampling Procedures

At each of the seven surface water sampling stations, samples were collected by dipping containers directly into the water surface. Samples to be analyzed for volatiles were obtained first with samples for additional analytical fractions collected immediately following. Care was taken to avoid excessive agitation that could result in loss of VOCs. Water quality readings were taken at each sampling station (i.e., pH, dissolved oxygen, salinity, specific conductance, and temperature). The water quality readings compiled during the surface water and sediment investigation are presented in Table 3-12.

Sediment samples were collected below the aqueous layer by driving a sediment corer, equipped with a disposable tube, into the sediments. The sediment was extruded from the disposable sampling tube and placed into the appropriate sample containers. Sampling containers were provided by the laboratory and certified to be contaminant free. The volatile fraction was collected first, followed by the remaining analytical parameters. Samples to be analyzed for TCL semivolatile, pesticides, PCBs, total organic carbon (TOC), and TAL metals were thoroughly homogenized before the sample jars were filled. The first six inches of sediment at each station were submitted for analyses separately from sediments collected in the 6- to 12-inch depth range. Surface water and sediment samples were collected at downstream sampling locations first. All sample locations were marked by placing a pin flag or wooden stake at the nearest point along the bank.

3.4.3 Analytical Program

The analytical program at Site 36 was intended to assess the nature and extent of contamination in surface waters and sediments that may have resulted from past disposal practices. As a result, the analytical program focused on suspected contaminants of concern, based upon knowledge of suspected wastes and the overall quality of surface water and sediment. Both surface water and sediment samples were analyzed for full TCL organics and TAL metals. Surface water samples were also analyzed for TAL dissolved metals and hardness. In addition to organic and inorganic analyses, sediment samples were also analyzed for TOC and grain size. Two additional sediment stations, 36-SD08 and 36-SD09, were sampled for TAL metals only, based upon the detection of lead above federal standards in one of the initial samples from 36-SD06. A summary of the surface water and sediment analytical program is provided in Table 3-13.

3.4.4 Quality Assurance and Quality Control

Field QA/QC samples were collected during the surface water and sediment investigation at Site 36, including duplicate samples, equipment rinsate samples, and trip blanks. Table 3-14 provides a summary of the QA/QC sampling program conducted during the surface water and sediment investigation. Section 3.2.5 lists the various QA/QC samples collected during the sampling program at Site 36 and the frequency at which they were obtained.

3.5 Aquatic Investigation

An aquatic investigation of Site 36 was conducted in conjunction with the surface water and sediment investigation at Site 35, during April and May of 1994. The subsections which follow discuss the type of media sampled, sampling locations, sampling procedures, and the analytical program.

3.5.1 Media Types

Biological samples collected at Site 36 were comprised of fish, crabs, and benthic macroinvertebrates. The biological samples were collected to obtain population statistics of fish and benthic macroinvertebrates and to obtain fish and crab tissue samples for chemical analysis.

3.5.2 Sampling Locations

In Brinson Creek, fish were collected from three stations adjacent to Site 36 (36-FS01, 36-FS02, and 36-FS03). Benthic macroinvertebrates were also collected from three stations adjacent to Site 36 in Brinson Creek (36-BN01, 36-BN02, and 36-BN03). Figure 3-6 shows the approximate locations of the three fish and three benthic sampling stations.

3.5.3 Sampling Procedures

Fish were collected at 36-FS01, 36-FS02 and 36-FS03 using a combination of gill nets, hoop nets, catfish traps, and minnow traps. Crabs were collected at 36-FS02 and 36-FS03 using crab pots. Crabs were not collected at 36-FS01, due to the low level of salinity.

The gill nets used to collect the fish were constructed of monofilament nylon, 50 or 100 feet in length, six-foot deep, and had a stretch mesh size ranging from 3 to 4 inches. The nets were deployed by securing the ends in the creek with 6-foot poles. Two yellow buoys marked with a phone number and the scientific collection permit number were attached to the end of each net.

The gill nets were deployed either in the morning or evening, and checked the following morning or evening. Fish that were dead for an extended period of time were not used for tissue analysis because of the potential for decomposition and leaching of contaminants from the organs into the edible portions of the fish.

The hoop nets ranged from 2 to 3.5 feet in diameter, and were 4.5 to 14 feet in length. The square mesh size was 1 to 1.5 inches. The nets were used with either 10, 25 or 40 foot wings. The hoop nets were deployed by attaching each wing to a 6.5 foot long post that was driven into the sediment, with the wings forming a 45 to 90 degree angle. The back of the hoop net was attached to a 6-foot fence

post and the net was stretched to pull the wings taught. This post then was driven into the sediment to secure the net in place. The nets were checked at least once daily; hoop nets typically do not kill the captured fish.

Catfish traps were deployed at each station. The catfish traps were approximately four to five feet in length and 15 inches in diameter. The traps were weighted and then set in the channel. Each was marked with a yellow buoy, for easy retrieval.

Minnow traps, baited with dog food, were deployed at each station along the right bank facing downstream. The traps were checked periodically during the sampling event.

Crabpots were used to collect blue crabs at each of the stations. The crab pots were either baited with chicken necks or dead fish obtained during the fish sampling. The crabpots were checked periodically throughout the sampling event.

Benthic macroinvertebrates were collected from a boat using a standard ponar sampler. The dimensions of the ponar sampler are 23 x 23 cm (9 x 9 in.) for a sampling area of 529 cm² or 0.0523 m² (81 in²). The ponar sampler was deployed from a boat which was positioned in slightly different locations for each replicate to avoid re-sampling the same area. After retrieving the ponar, it was opened into a clean tub and the sediments were removed with a Teflon™ spatula. The sediments were transferred to a 0.5 mm sieve that was agitated by hand in water to remove small particles. The remaining contents in the sieve were transferred into 16-ounce plastic sample jars. The jars were filled to one-half full with sediment and buffered formalin solution (10 percent by weight) was added to the remainder of the jar to preserve the benthic macroinvertebrates contained in the sediment. A 100 percent cotton paper label, marked in pencil with the sample number, was placed inside the jar. The outside of the jar was labeled with the sample number using a black permanent marker to identify the sample containers.

3.5.4 Analytical Program

The analytical program at Site 36 was intended to accurately represent the nature of contamination in biotic organisms which may have resulted from past disposal practices at Site 36. The analytical program focused on suspected contaminants of concern and species diversity. Fish tissue samples were analyzed for full TCL organics and TAL inorganics. A taxonomic identification of benthic macroinvertebrates was also performed.

3.6 Habitat Evaluation

During the habitat evaluation at Site 36, dominant vegetation types and species were identified in the field; those plants that could not be readily identified were collected for further examination in the office. Amphibians, reptiles, birds, and mammals were also identified as visual sightings or evidence allowed. In many cases, the animals themselves were not seen, but scat, tracks, feeding areas, or remains were noted. From this information, ecological communities were established and biohabitat maps developed (see Section 2.0).

3.7 Decontamination Procedures

Decontamination procedures performed in the field were initiated in accordance with USEPA Region IV SOPs. Sampling and drilling equipment were divided into two decontamination groups, heavy equipment and routine sample collection equipment. Heavy equipment included the drill rig, hollow-stem augers, and drill and sampling rods. Routine sample collection equipment included split spoons, stainless steel core barrels (used with the GeoProbe™), and stainless steel spoons and bowls, and Teflon™ tubing.

The following procedures were implemented for heavy equipment:

- Removal of caked-on soil with brush
- Steam clean with high-pressure steam
- Air dry

The following procedures were implemented for routine sample collection equipment:

- Clean with distilled water and laboratory detergent (Liquinox soap solution)
- Rinse thoroughly with distilled water
- Rinse twice with isopropol alcohol
- Air dry
- Wrap in aluminum foil, if appropriate

Temporary decontamination pads, constructed of wood and plastic, were constructed to prevent spillage of fluids onto the ground surface. Decontamination fluids generated during the field program were containerized and handled according to the procedures outlined in Section 3.8.

3.8 Investigation Derived Waste (IDW) Handling

Field investigation activities at Site 36 resulted in the generation of various IDW. This IDW included drilling mud, soil cuttings, well development and purge water, and solutions used to decontaminate non-disposable sampling equipment. The general management techniques utilized for the IDW were:

1. Collection and containerization of IDW material.
2. Temporary storage of IDW while awaiting confirmatory analytical data.
3. Final disposal of aqueous and solid IDW material.

The management of the IDW was performed in accordance with guidelines developed by the USEPA Office of Emergency and Remedial Response, Hazardous Site Control Division (USEPA, 1992). Both the IDW soils and water were returned, based on confirmatory analytical data, to their respective source areas. Contaminated wastewater was sent off site to a licensed hazardous waste disposal facility. Appendix F provides information regarding the management and disposal of the IDW.

3.9 References

American Society for Testing and Materials (ASTM). 1993. Standard Practice for Description and Identification of Soils (Visual Manual Procedure). ASTM D-2488-93. American Society for Testing and Materials, Philadelphia, Pennsylvania.

Baker Environmental, Inc. 1994. Remedial Investigation/Feasibility Study Work Plan for Operable Unit No. 6 (Sites 43, 43, 54, 54, and 86), Marine Corps Base Camp Lejeune, North Carolina. Final. Prepared for the Department of the Navy, Naval Facilities Engineering Command, Atlantic Division, Norfolk, Virginia. December 1994.

Environmental Science and Engineering, Inc. (ESE) 1990. Site Summary Report. Final. Marine Corps Base, Camp Lejeune, North Carolina. Prepared for the Department of the Navy, Naval Facilities Engineering Command, Atlantic Division, Norfolk, Virginia. ESE Project No. 49-02043. September 1990.

Naval Energy and Environmental Support Activity (NEESA). 1988. Sampling and Chemical Analysis Quality Assurance Requirements for the Navy Installation Restoration Program. Department of the Navy, Naval Energy and Environmental Support Activity, Port Hueneme, California. NEESA 20.2-047B.

United States Environmental Protection Agency (USEPA). 1991. National Functional Guidelines for Organic Data Review. Draft. USEPA Contract Laboratory Program. June 1991.

United States Environmental Protection Agency (USEPA). 1992. Guide to Management of Investigation-Derived Wastes. Office of Emergency and Remedial Response Hazardous Site Control Division. Washington, D.C. OS-220W. April 1992.

SECTION 3.0 TABLES

TABLE 3-1

SOIL SAMPLING SUMMARY
 TEST BORINGS
 SITE 36, CAMP GEIGER AREA DUMP
 REMEDIAL INVESTIGATION, CTO-0303
 MCB, CAMP LEJEUNE, NORTH CAROLINA

Sample Location	Depth of Borehole (feet, below ground surface)	Sampling Interval (feet, below ground surface)	Analytical Parameters					
			TCL Pest/PCB	TAL Metals	TCL VOC	TCL SVOC	Duplicate Sample	MS/MSD
36-DAB-SB01	5	0-1	X	X	X	X		
		1-3	X	X	X	X	X	X
36-DAB-SB02	9	0-1	X	X	X	X		
		3-5	X	X	X	X		
36-DAB-SB03	7	0-1	X	X	X	X		
		3-5	X	X	X	X		
36-DAD-SB01	1	0-1	X	X	X	X		
36-DAD-SB02	3	0-1	X	X	X	X	X	
		1-3	X	X	X	X		
36-DAD-SB03	7	0-1	X	X	X	X		
36-FCA-SB01	9	0-1	X	X	X	X		
		7-9	X	X	X	X		
36-FCA-SB02	11	0-1	X	X	X	X		
		7-9	X	X	X	X		
36-FCA-SB03	7	0-1	X	X	X	X		
		3-5	X	X	X	X		
36-FCA-SB04	7	0-1	X	X	X	X		
		3-5	X	X	X	X		
36-FCA-SB05	7	0-1	X	X	X	X		
		3-5	X	X	X	X		
36-FCA-SB06	9	0-1	X	X	X	X		
		5-7	X	X	X	X		
36-FCA-SB07	5	0-1	X	X	X	X		
		1-3	X	X	X	X		X
36-FCA-SB08	5	0-1	X	X	X	X		
		1-3	X	X	X	X		
36-FCA-SB09	7	0-1	X	X	X	X		
		3-5	X	X	X	X		
36-FCA-SB10	7	0-1	X	X	X	X		
		3-5	X	X	X	X		
36-FCA-SB11	7	0-1	X	X	X	X		
		5-7	X	X	X	X		
36-FCA-SB12	5.5	0-1	X	X	X	X		
		5-7	X	X	X	X		
36-FCA-SB13	5	0-1	X	X	X	X	X	X
		1-3	X	X	X	X		
36-FCA-SB14	5	0-1	X	X	X	X		
		1-3	X	X	X	X		

TABLE 3-1 (Continued)

**SOIL SAMPLING SUMMARY
TEST BORINGS
SITE 36, CAMP GEIGER AREA DUMP
REMEDIAL INVESTIGATION, CTO-0303
MCB, CAMP LEJEUNE, NORTH CAROLINA**

Sample Location	Depth of Borehole (feet, below ground surface)	Sampling Interval (feet, below ground surface)	Analytical Parameters					
			TCL Pest/PCB	TAL Metals	TCL VOC	TCL SVOC	Duplicate Sample	MS/MSD
36-FDA-SB01	7	0-1	X	X	X	X		
		3-5	X	X	X	X		
36-FDA-SB02	11	0-1	X	X	X	X		
		7-9	X	X	X	X		
36-FDA-SB03	11	0-1	X	X	X	X		
		7-9	X	X	X	X		
36-FDA-SB04	7	0-1	X	X	X	X	X	X
		1-3	X	X	X	X		
36-FDA-SB05	7	0-1	X	X	X	X		
		1-3	X	X	X	X		
36-FDA-SB06	17	0-1	X	X	X	X		
		13-15	X	X	X	X		
36-OA-SB01	5	0-1	X	X	X	X		
		1-3	X	X	X	X		
36-OA-SB01A	5	0-1	X	X	X	X		
		1-3	X	X	X	X		
36-OA-SB01B	3	0-1	X	X	X	X		
		1-3	X	X	X	X		X
36-OA-SB01C	5	0-1	X	X	X	X		
		1-3	X	X	X	X		
36-OA-SB01D	5	0-1	X	X	X	X		
		1-3	X	X	X	X		
36-OA-SB01E	5	0-1	X					
		3-5	X					
36-OA-SB01F	5	0-1	X					
		3-5	X					
36-OA-SB01G	5	0-1	X					
		3-5	X					
36-OA-SB01H	5	0-1	X					
		3-5	X					
36-OA-SB01I	5	0-1	X					
		3-5	X					
36-OA-SB01J ⁽²⁾	1	0-1	X					
36-OA-SB01K ⁽²⁾	1	0-1	X					
36-OA-SB01L ⁽²⁾	1	0-1	X					
36-OA-SB01M ⁽²⁾	1	0-1	X					

TABLE 3-1 (Continued)

**SOIL SAMPLING SUMMARY
TEST BORINGS
SITE 36, CAMP GEIGER AREA DUMP
REMEDIAL INVESTIGATION, CTO-0303
MCB, CAMP LEJEUNE, NORTH CAROLINA**

Sample Location	Depth of Borehole (feet, below ground surface)	Sampling Interval (feet, below ground surface)	Analytical Parameters					
			TCL Pest/PCB	TAL Metals	TCL VOC	TCL SVOC	Duplicate Sample	MS/MSD
36-OA-SB02	9	0-1	X	X	X	X		X
		5-7	X	X	X	X		
36-OA-SB03	11	0-1	X	X	X	X		
		5-7	X	X	X	X		
36-OA-SB04	7	0-1	X	X	X	X		
		3-5	X	X	X	X		
36-OA-SB06	7	0-1	X	X	X	X		
		3-5	X	X	X	X		
36-OA-SB07	4	0-1	X	X	X	X		
		1-3	X	X	X	X		
36-OA-SB08	5	0-1	X	X	X	X		
		1-3	X	X	X	X		
36-OF-SB01	13	0-1	X	X	X	X		
		7-9	X	X	X	X		
36-OF-SB02	9	0-1	X	X	X	X		
		3-5	X	X	X	X		
36-OF-SB03	9	0-1	X	X	X	X		
		5-7	X	X	X	X		
36-OF-SB03A ⁽²⁾	1	0-1	X					
36-OF-SB03B ⁽²⁾	1	0-1	X					
36-OF-SB03C ⁽²⁾	1	0-1	X					
36-OF-SB03D ⁽²⁾	1	0-1	X					
36-OF-SB04	11	0-1	X	X	X	X		
		5-7	X	X	X	X		
36-OF-SB04A ⁽²⁾	1	0-1				X		
36-OF-SB04B ⁽²⁾	1	0-1				X		
36-OF-SB04C ⁽²⁾	1	0-1				X		
36-OF-SB04D ⁽²⁾	1	0-1				X		
36-OF-SB05	13	0-1	X	X	X	X		X
		11-3	X	X	X	X		
36-OF-SB06	11	0-1	X	X	X	X		
		5-7	X	X	X	X		
36-OF-SB06A	9	0-1	X	X	X	X		
		1-3	X	X	X	X		
36-OF-SB06B	7	0-1	X	X	X	X		
		3-5	X	X	X	X		
36-OF-SB06C	9	0-1	X	X	X	X		
		3-5	X	X	X	X		

TABLE 3-1 (Continued)

**SOIL SAMPLING SUMMARY
TEST BORINGS
SITE 36, CAMP GEIGER AREA DUMP
REMEDIAL INVESTIGATION, CTO-0303
MCB, CAMP LEJEUNE, NORTH CAROLINA**

Sample Location	Depth of Borehole (feet, below ground surface)	Sampling Interval (feet, below ground surface)	Analytical Parameters					
			TCL Pest/PCB	TAL Metals	TCL VOC	TCL SVOC	Duplicate Sample	MS/MSD
36-OF-SB06D	7	0-1	X	X	X	X		
		3-5	X	X	X	X		
36-GS-SB01	9	0-1			X	X		
		7-9			X	X		
36-GS-SB02	9	0-1			X	X		
		7-9			X	X		
36-GS-SB03	5	0-1			X	X		
		3-5			X	X		
36-GS-SB04	7	0-1			X	X		
		5-7			X	X		
36-GS-SB05	7	0-1			X	X		
		1-3			X	X	X	X
		5-7			X	X	X	
36-GS-SB06	5	0-1			X	X		
		3-5			X	X		
36-BB-SB01 ⁽¹⁾	7	0-1	X	X	X	X		
		3-5	X	X	X	X		
36-BB-SB02 ⁽¹⁾	7	0-1	X	X	X	X		
		3-5	X	X	X	X		
36-BB-SB03 ⁽¹⁾	7	0-1	X	X	X	X		
		3-5	X	X	X	X		

Notes:

- (1) Background or control sample location.
- (2) Confirmatory samples, results not validated.

TABLE 3-2

**SOIL SAMPLING SUMMARY
MONITORING WELL TEST BORINGS
SITE 36, CAMP GEIGER AREA DUMP
REMEDIAL INVESTIGATION, CTO-0303
MCB, CAMP LEJEUNE, NORTH CAROLINA**

Sample Location	Depth of Borehole (feet, below ground surface)	Sampling Interval (feet, below ground surface)	Analytical Parameters							
			TCL Pest/PCB	TAL Metals	TCL VOC	TCL SVOC	RCRA	TCLP	Engineering Parameters ⁽¹⁾	Duplicate Sample
36-GW07	19	0-1	X	X	X	X				
		1-3	X	X	X	X				
36-GW-07DW	64	0-10							X	
36-GW09	13	0-1	X	X	X	X				
		7-9	X	X	X	X				
36-GW10	21.5	0-1	X	X	X	X				X
		5-7	X	X	X	X				
36-GW11	13	0-1	X	X	X	X				X
		7-9	X	X	X	X				
		11-13	X	X	X	X				
36-GW12	21	0-1			X					
		5-7			X					
36-GW13	20	0-1			X					
		3-5			X					
		5-7			X					
36-GW14	19	0-1			X					
		3-5			X					

Notes:

⁽¹⁾ Engineering parameters include grain size and Atterberg limits of composite sample.

TABLE 3-3

**SOIL SAMPLING SUMMARY
EXPLORATORY TEST PITS
SITE 36, CAMP GEIGER AREA DUMP
REMEDIAL INVESTIGATION, CTO-0303
MCB, CAMP LEJEUNE, NORTH CAROLINA**

Sample Location	Depth/Length of Excavation (feet)	Sampling Interval (feet)	Analytical Parameters					
			TCL Pest/PCB	TAL Metals	RCRA	TCL VOC	TCL SVOC	TCLP
36-TP02	5.3/25	1 - 2			X			X
36-TP03	7/20	5	X	X		X	X	
36-TP07	8/20	0 - 3			X			X

Notes:

RCRA - Resource Conservation and Recovery Act
Hazardous Waste Characteristics

TCLP - Full Toxicity Characteristic Leaching Procedure Analysis (Volatiles, Semivolatiles, Pesticides, PCBs, and Metals)

TABLE 3-4

QUALITY ASSURANCE/QUALITY CONTROL SAMPLING PROGRAM
 SOIL INVESTIGATION
 SITE 36, CAMP GEIGER AREA DUMP
 REMEDIAL INVESTIGATION, CTO-0303
 MCB, CAMP LEJEUNE, NORTH CAROLINA

QA/QC Sample ⁽¹⁾	Frequency of Collection	Number of Samples	Analytical Parameters
Trip Blanks ⁽²⁾	One per collar	9	TCL Volatiles
Field Blanks ⁽³⁾	One per event	1	TCL VOC, TCL SVOC, TCL PEST/PCB, TAL Metals
Equipment Rinsates ⁽⁴⁾	One per day	5	TCL VOC, TCL SVOC, TCL PEST/PCB, TAL Metals
Field Duplicates ⁽⁵⁾	10% of sample frequency	13	TCL VOC, TCL SVOC, TCL PEST/PCB, TAL Metals

- Notes: (1) QA/QC sample types defined in Section 3.2.5 in text.
 (2) Trip blanks submitted with coolers which contained samples for volatile analysis. Samples analyzed for TCL Volatiles only.
 (3) Field blank collected during the soil investigation from water source used for decontamination.
 (4) Equipment rinsates collected from various sampling equipment (e.g., stainless steel core barrels).
 (5) Field duplicate samples presented in Appendix J.

TABLE 3-5

SUMMARY OF WELL CONSTRUCTION DETAILS
 SITE 36, CAMP GEIGER AREA DUMP
 REMEDIAL INVESTIGATION, CTO-0303
 MCB, CAMP LEJEUNE, NORTH CAROLINA

Well No.	Date Installed	Top of PVC Casing Elevation (feet, above msl) ⁽¹⁾	Ground Surface Elevation (feet, above msl)	Boring Depth (feet, below ground surface)	Well Depth (feet, below ground surface)	Screen Interval Depth (feet, below ground surface)	Sand Pack Interval Depth (feet, below ground surface)	Bentonite Interval Depth (feet, below ground surface)
36-TW01	3/14/95	NA	2.60	8	8	3-8	NA	NA
36-TW02	3/14/95	NA	3.40	8	5.5	0.5-5.5	NA	NA
36-GW06	2/28/95	19.06	16.9	19	18	3-18	2-18.5	0-2
36-GW06DW	2/23/95	19.00	16.6	71	70	65-70	63-71	57-63
36-GW07	3/7/95	11.51	9.4	19	18	3-18	2-19	0-2
36-GW07DW	3/7/95	11.26	9.2	64	63	58-63	55.8-64	51-55.8
36-GW08	2/28/95	18.42	16.2	25	24	9-24	6.5-24	0-6.5
36-GW09	3/9/95	13.52	11.8	21.5	20.5	5.5-20.5	3.5-21	0-3.5
36-GW10	3/9/95	9.04	7.3	21.5	20.5	5.5-20.5	3-20.5	0-3
36-GW10IW	4/22/95	9.88	7.1	35	34	24-34	22-35	19-22
36-GW10DW	6/28/95	9.55	7.2	68	67.1	62-67	60-68	39-60
36-GW11	3/9/95	17.65	15.2	25	24	9-24	7-25	0-7
36-GW11DW	2/25/95	18.08	15.9	73	72	67-72	64-73	55-64
36-GW12	4/23/95	11.64	9.9	21	20	5-20	3-21	1-3
36-GW12IW	4/23/95	12.15	9.9	36	36	26-36	21-36	17-21
36-GW13	4/24/95	6.19	4.0	20	19	4-19	3-20	0.5-3
36-GW13IW	4/24/95	5.98	3.8	34	33	23-33	18-34	15-18
35-GW14	4/24/95	16.25	13.9	19	18	3-18	1-19	0-1

Notes: ⁽¹⁾ msl = mean sea level

Horizontal positions are referenced to N.C. State Plane Coordinate System (NAD 27) CF = 0.9999216 from USMC Monument Toney.

Vertical datum NGVD 29.

NA - Not Applicable

TABLE 3-6

SUMMARY OF WATER LEVEL MEASUREMENTS
 SITE 36, CAMP GEIGER AREA DUMP
 REMEDIAL INVESTIGATION, CTO-0303
 MCB, CAMP LEJEUNE, NORTH CAROLINA

Well No.	Top of PVC Casing Elevation (feet, above msl) ⁽¹⁾	Depth to Groundwater (feet, below top of casing) March 23, 1995	Depth to Groundwater (feet, below top of casing) April 10, 1995	Depth to Groundwater (feet, below top of casing) May 9, 1994	Depth to Groundwater (feet, below top of casing) August 18, 1995	Groundwater Elevation (feet, above msl) March 23, 1995	Groundwater Elevation (feet, above msl) April 10, 1995	Groundwater Elevation (feet, above msl) May 9, 1995	Groundwater Elevation (feet, above msl) August 18, 1995
36-GW01	8.93	6331	6.95	7.31	7.08	2.62	1.98	1.62	1.85
36-GW02	8.80	6.39	7.00	7.20	NA	2.41	1.80	1.60	NA
36-GW03	8.70	6.26	6.95	7.15	6.40	2.44	1.75	1.55	2.30
36-GW04	14.24	5.51	6.64	7.94	8.90	8.73	7.60	6.30	5.34
36-GW05	16.50	6.50	7.49	8.75	9.21	10.00	9.01	7.75	7.29
36-GW06	19.06	6.52	7.53	8.59	9.22	12.54	11.53	10.47	9.84
36-GW06DW ⁽²⁾	19.00	10.26	11.09	12.06	14.92	8.74	7.91	6.94	4.08
36-GW07	11.51	2.75	3.76	5.38	5.94	8.76	7.75	6.13	5.57
36-GW07DW ⁽²⁾	11.26	3.05	3.86	4.95	5.70	8.21	7.40	6.31	5.56
36-GW08	18.42	9.43	10.70	12.40	12.98	8.99	7.72	6.02	5.44
36-GW09	13.52	8.62	8.85	9.79	9.63	4.90	4.67	3.73	3.89
36-GW10	9.04	6.81	7.38	7.51	7.26	2.23	1.66	1.53	1.78
36-GW10IW ⁽⁴⁾	9.88	NA	NA	8.35	8.11	NA	NA	1.53	1.77
36-GW11	17.65	14.34	15.69	16.01	15.76	3.31	1.96	1.64	1.89
36-GW11DW ⁽²⁾	18.08	15.30	15.90	16.31	16.18	2.78	2.18	1.77	1.90
36-GW12	1.64	NA	NA	10.02	9.72	NA	NA	1.64	1.92
36-GW12IW ⁽⁴⁾	12.15	NA	NA	10.54	10.24	NA	NA	1.61	1.91
36-GW13	6.19	NA	NA	4.67	4.42	NA	NA	1.52	1.77
36-GW13IW ⁽⁴⁾	5.98	NA	NA	4.45	4.24	NA	NA	1.53	1.74
36-GW14	16.25	NA	NA	12.95	13.24	NA	NA	3.30	3.01
36-SG01 ⁽³⁾	3.18	1.02	NA	1.67	NA	2.16	NA	1.51	NA

Notes:

- (1) msl = mean sea level
- (2) Deep monitoring well
- (3) Intermediate monitoring well
- (4) Staff gauge
- NA Data not available

TABLE 3-7

**SUMMARY OF GROUNDWATER FIELD PARAMETERS
ROUND ONE
SITE 36, CAMP GEIGER AREA DUMP
REMEDIAL INVESTIGATION, CTO-0303
MCB, CAMP LEJEUNE, NORTH CAROLINA**

Well No.	Depth of Well (ft.)	Purge Volume (gals.)	Field Parameters				
Date of Measurement			Well Volume	Specific Conductance at 25°C (micromhos/cm)	Temperature (°C)	pH (S.U.)	Turbidity (T.U.)
36-GW01	23.03	7.8	0.5	768.0	15.0	7.05	17.0
3/28/95			1.0	830.0	15.0	7.06	15.1
			1.5	861.0	15.0	7.11	9.2
			2.0	826.0	17.0	7.08	4.8
			2.5	861.0	15.0	7.08	2.8
			3.0	861.0	15.0	7.09	1.9
36-GW02	22.04	8.75	0.5	1020.0	16.5	6.78	16.6
3/27/95			1.0	1020.0	16.5	6.76	41.0
			2.0	973.0	17.0	6.89	10.8
			3.0	944.0	17.0	6.83	4.4
			3.5	960.0	16.5	6.58	2.8
36-GW03	20.98	12.5	0	215.0	15.0	6.49	44.1
3/26/95			1.0	230.0	16.0	6.46	51.5
			2.0	228.0	16.0	6.50	14.7
			3.0	224.0	16.5	6.46	4.4
			4.0	224.0	17.0	6.44	2.6
			5.0	224.0	17.0	6.43	2.0
36-GW04	21.9	10.8	0	275.0	14.5	6.08	46.5
3/26/95			1.0	252.0	14.0	5.98	3.1
			2.0	253.0	13.5	6.00	2.0
			3.0	253.0	13.4	6.01	1.8
			3.5	243.0	13.5	6.00	1.6
			4.0	245.0	13.0	6.00	1.7
36-GW05	27.69	10.8	0	205.0	15.9	5.89	5.6
3/26/95			1.0	196.0	16.5	5.97	1.5
			2.0	210.0	16.0	5.99	1.3
			3.0	204.0	16.0	6.02	0.8
36-GW06	18.0	9.0	1.0	340.0	14.0	4.91	1.07
3/27/95			2.0	333.0	14.0	4.97	0.70
			3.0	333.0	14.0	4.95	0.70
			4.0	327.0	14.0	4.91	0.57
			5.0	340.0	14.0	4.90	0.39

TABLE 3-7 (Continued)

SUMMARY OF GROUNDWATER FIELD PARAMETERS
 ROUND ONE
 SITE 36, CAMP GEIGER AREA DUMP
 REMEDIAL INVESTIGATION, CTO-0303
 MCB, CAMP LEJEUNE, NORTH CAROLINA

Well No.	Depth of Well (ft.)	Purge Volume (gals.)	Field Parameters				
Date of Measurement			Well Volume	Specific Conductance at 25°C (micromhos/cm)	Temperature (°C)	pH (S.U.)	Turbidity (T.U.)
36-GW06DW	67.5	27.42	0.5	632.0	20.0	7.64	7.9
3/26/95			1.0	715.0	20.0	7.45	3.1
			1.5	672.0	19.0	7.43	1.7
			2.0	672.0	19.0	7.48	1.4
			2.5	672.0	18.5	7.42	0.8
			3.0	772.0	18.0	7.43	0.7
36-GW07	18.0	7.26	1.0	712.0	18.5	6.68	7.8
3/26/95			1.5	805.0	18.0	6.60	6.6
			2.0	754.0	17.5	6.60	5.3
			2.5	805.0	18.0	6.53	5.0
			3.0	716.0	19.0	6.53	4.1
36-GW07DW	65.0	35.25	0.5	1254.0	18.5	7.63	8.6
3/26/95			1.0	1232.0	19.0	7.65	3.0
			1.5	912.0	18.5	7.55	2.0
			2.0	784.0	19.0	7.51	1.4
			2.5	660.0	20.0	7.51	1.2
			3.0	660.0	20.0	7.47	0.9
			3.25	605.0	20.0	NA	0.9
36-GW08	24.0	9.6	0.0	371.0	17.5	6.19	49.1
3/27/95			1.0	336.0	17.5	6.09	2.1
			2.0	312.0	17.5	6.04	0.9
			2.5	322.0	17.5	6.06	1.3
			3.0	307.0	17.5	6.08	1.0
			3.5	301.0	17.5	6.04	0.8
			4.0	305.0	17.0	6.06	0.9
			36-GW09	20.5	6.65	1.0	1485.0
3/27/95	2.0	1540.0	20.0			6.60	15.2
	2.5	1350.0	21.0			6.76	9.1
	3.0	1100.0	20.0			6.74	7.8
	3.5	1375.0	20.0			6.71	3.2

TABLE 3-7 (Continued)

SUMMARY OF GROUNDWATER FIELD PARAMETERS
 ROUND ONE
 SITE 36, CAMP GEIGER AREA DUMP
 REMEDIAL INVESTIGATION, CTO-0303
 MCB, CAMP LEJEUNE, NORTH CAROLINA

Well No.	Depth of Well (ft.)	Purge Volume (gals.)	Field Parameters				
Date of Measurement			Well Volume	Specific Conductance at 25°C (micromhos/cm)	Temperature (°C)	pH (S.U.)	Turbidity (T.U.)
36-GW10	21.86	12.5	0	738.0	15.0	6.58	23.8
3/25/95			1.0	840.0	16.0	6.49	31.0
			2.0	837.0	16.2	6.44	12.4
			3.0	821.0	16.5	6.48	5.4
			4.0	725.0	16.5	6.50	3.5
			5.0	732.0	16.0	6.51	0.7
36-GW10IW	36.9	15.0	0	883.0	19.8	6.90	42.3
5/9/95			0.5	872.0	19.9	6.95	16.3
			1.0	860.0	20.0	6.93	14.9
			1.5	932.0	20.1	6.91	12.7
			2.0	929.0	20.9	6.91	8.7
			2.5	928.0	21.0	6.90	5.1
			3.0	926.0	21.0	6.91	NA
36-GW10DW	67.2	35.0	0.5	21.5	19.2	9.48	2.28
7/12/95			1.0	21.2	18.8	10.08	6.25
			1.5	21.2	18.8	9.64	4.67
			2.0	21.3	19.1	9.33	2.22
			2.5	21.2	19.0	9.06	2.21
			3.0	21.6	19.5	8.89	1.75
			3.5	21.8	19.7	8.78	1.67
			36-GW11	25.7	5.37	0	1265.0
3/27/95	0.5	1232.0	20.0			7.38	3.2
	1.0	1210.0	19.9			7.33	2.0
	1.5	1210.0	20.0			7.34	1.3
	2.0	1221.0	20.0			7.34	0.8
	2.5	1210.0	20.1			7.31	0.5
	3.0	1210.0	20.0			7.26	0.4
36-GW11DW	72.0	28.8	0	NA	16.3	8.43	1.8
3/27/95			0.5	702.0	17.2	7.77	2.9
			1.0	696.0	17.7	7.58	1.5
			1.5	690.0	18.0	7.93	1.0
			2.0	686.0	18.3	8.32	0.7
			2.5	786.0	18.3	8.33	0.4
			3.0	741.0	18.4	8.32	0.3

TABLE 3-7 (Continued)

SUMMARY OF GROUNDWATER FIELD PARAMETERS
 ROUND ONE
 SITE 36, CAMP GEIGER AREA DUMP
 REMEDIAL INVESTIGATION, CTO-0303
 MCB, CAMP LEJEUNE, NORTH CAROLINA

Well No.	Depth of Well (ft.)	Purge Volume (gals.)	Field Parameters				
Date of Measurement			Well Volume	Specific Conductance at 25°C (micromhos/cm)	Temperature (°C)	pH (S.U.)	Turbidity (T.U.)
36-GW12	21.8	12.0	0	538.0	21.4	6.71	71.9
5/8/95			1.0	542.0	20.5	6.80	69.3
			2.0	555.0	21.6	6.87	97.9
			3.0	537.0	21.3	6.94	36.6
			4.0	547.0	21.5	6.95	15.1
			5.0	551.0	21.3	6.93	9.9
			6.0	521.0	22.3	7.01	9.1
36-GW12IW	38.2	15.0	0	568.0	20.8	7.08	17.5
5/8/95			0.5	564.0	20.5	7.13	11.6
			1.0	560.0	20.8	7.13	3.1
			1.5	552.0	20.9	7.14	2.0
			2.0	545.0	21.2	7.16	1.5
			2.5	564.0	21.5	7.21	1.1
			3.0	553.0	22.8	7.25	0.7
36-GW13	21.7	20.0	0	655.0	15.5	6.92	>200
5/9/95			1.0	619.0	16.8	7.00	>200
			2.0	605.0	16.8	7.02	65.2
			3.0	632.0	16.2	7.09	16.3
			4.0	637.0	16.2	7.07	9.8
			5.0	627.0	16.3	7.08	7.0
36-GW13IW	35.7	15.9	0	621.0	19.1	7.31	75.1
5/8/95			0.5	624.0	18.0	7.33	59.6
			1.0	609.0	18.4	7.37	16.8
			1.5	605.0	18.6	7.37	11.7
			2.0	604.0	18.4	7.39	6.9
			2.5	604.0	18.5	7.36	5.3
			3.0	599.0	18.2	7.38	5.3

TABLE 3-7 (Continued)

SUMMARY OF GROUNDWATER FIELD PARAMETERS
 ROUND ONE
 SITE 36, CAMP GEIGER AREA DUMP
 REMEDIAL INVESTIGATION, CTO-0303
 MCB, CAMP LEJEUNE, NORTH CAROLINA

Well No.	Depth of Well (ft.)	Purge Volume (gals.)	Field Parameters				
Date of Measurement			Well Volume	Specific Conductance at 25°C (micromhos/cm)	Temperature (°C)	pH (S.U.)	Turbidity (T.U.)
36-GW14	21.5	7.5	0	302.0	17.5	6.39	5.94
5/8/95			1.0	303.0	17.9	6.42	2.4
			2.0	302.0	17.9	6.43	2.8
			3.0	302.0	17.7	6.44	4.3
			4.0	303.0	18.1	6.48	5.1
			5.0	295.0	19.0	6.50	5.3

Notes:

- S.U. Standard Units
- °C Degrees centigrade
- T.U. Turbidity Units

TABLE 3-8

**SUMMARY OF GROUNDWATER FIELD PARAMETERS
ROUND TWO
SITE 36, CAMP GEIGER AREA DUMP
REMEDIAL INVESTIGATION, CTO-0303
MCAS, NEW RIVER, NORTH CAROLINA**

Well No.	Depth of Well (ft.)	Purge Volume (gals.)	Field Parameters				
Date of Measurement			Well Volume	Specific Conductance at 25°C (micromhos/cm)	Temperature (°C)	pH (S.U.)	Turbidity (T.U.)
36-GW10	21.0	9.5	0.5	22.5	20.9	6.62	192.5
7/11/95			1.0	22.0	20.0	6.69	50.4
			2.0	21.8	19.7	6.83	5.70
			3.5	21.8	19.7	6.85	2.68
			4.0	21.6	19.5	6.81	1.96
36-GW10IW	34.5	14.5	0.5	20.8	18.3	6.93	6.70
7/11/95			1.0	20.8	18.3	6.87	.46
			1.5	20.9	18.4	6.84	.31
			2.0	20.7	18.2	6.83	.25
			2.5	21.0	18.5	6.81	.54
			3.0	20.7	18.2	6.81	.29
36-GW12	21.5	12.5	1.0	22.8	19.5	6.34	8.71
7/11/95			2.0	21.3	18.9	6.76	27.8
			3.0	21.7	19.4	6.85	4.62
			3.5	21.5	19.2	6.89	3.98
			4.0	21.8	19.7	6.88	6.88
			5.0	21.6	19.3	6.91	6.04
			5.5	21.8	19.7	6.91	5.74
36-GW12IW	36.5	16.0	0.5	20.7	18.2	7.21	.54
7/11/95			1.0	20.7	18.2	7.17	.22
			1.5	20.9	18.4	7.19	.21
			2.0	20.9	18.4	7.18	.18
			3.0	21.0	18.5	7.18	.28
			3.5	21.0	18.5	7.22	.24
36-GW13	2.49	10.2	0.5	21.7	19.4	7.02	3.18
7/11/95			1.0	20.8	18.3	7.04	1.86
			2.0	20.8	18.1	7.05	.63
			2.5	20.7	18.2	7.06	.47
			3.0	20.8	18.3	7.03	.33

TABLE 3-8 (Continued)

SUMMARY OF GROUNDWATER FIELD PARAMETERS
 ROUND TWO
 SITE 36, CAMP GEIGER AREA DUMP
 REMEDIAL INVESTIGATION, CTO-0303
 MCAS, NEW RIVER, NORTH CAROLINA

Well No.	Depth of Well (ft.)	Purge Volume (gals.)	Field Parameters				
Date of Measurement			Well Volume	Specific Conductance at 25°C (micromhos/cm)	Temperature (°C)	pH (S.U.)	Turbidity (T.U.)
36-GW131W	4.79	16.0	0.5	20.7	18.0	7.37	1.03
7/11/95			1.0	20.8	18.1	7.34	.77
			2.0	20.7	18.2	7.37	.76
			2.5	21.0	18.5	7.33	.31
			3.0	21.0	18.5	7.35	.36

Notes:

- S.U. Standard Units
- °C degrees centigrade
- T.U. Turbidity Units

TABLE 3-9

**GROUNDWATER SAMPLING SUMMARY
ROUND ONE
SITE 36, CAMP GEIGER AREA DUMP
REMEDIAL INVESTIGATION, CTO-0303
MCB, CAMP LEJEUNE, NORTH CAROLINA**

Sample Location	Analytical Parameters								
	TCL VOC	TCL SVOC	TCL Pest./ PCB	TAL Metals	Dissolved TAL Metals	TSS	TDS	Duplicate Sample	MS/ MSD
36-TW01	X	X	X						
36-TW02	X	X	X	X	X	X	X		
36-GW01	X	X	X	X	X	X	X		
36-GW02	X	X	X	X		X	X	X	
36-GW03	X	X	X	X		X	X		
36-GW04	X	X	X	X		X	X		
36-GW05	X	X	X	X		X	X		
36-GW06	X	X	X	X		X	X	X	X
36-GW016DW	X	X	X	X		X	X		
36-GW07	X	X	X	X		X	X		
36-GW07DW	X	X	X	X		X	X		
36-GW08	X	X	X	X	X	X	X		
36-GW09	X	X	X	X		X	X		
36-GW10	X	X	X	X		X	X		
36-GW10IW	X			X		X	X	X	
36-GW11	X	X	X	X		X	X		
36-GW11DW	X	X	X	X		X	X		
36-GW12	X			X		X	X		
36-GW12IW	X			X		X	X		
36-GW13	X			X		X	X		
36-GW13IW	X			X		X	X		
36-GW14	X			X	X	X	X		

Notes:

TSS = Total Suspended Solids

TDS = Total Dissolved Solids

TABLE 3-10

**GROUNDWATER SAMPLING SUMMARY
ROUND TWO
SITE 36, CAMP GEIGER AREA DUMP
REMEDIAL INVESTIGATION, CTO-0303
MCB, CAMP LEJEUNE, NORTH CAROLINA**

Sample Location	Analytical Parameters	
	TCL VOC	TCL Pest/PCB
36-GW10	X	X
36-GW10IW	X	
36-GW12	X	
36-GW12IW	X	
36-GW13	X	
36-GW13IW	X	

TABLE 3-11

QUALITY ASSURANCE/QUALITY CONTROL SAMPLING PROGRAM
 GROUNDWATER INVESTIGATION
 SITE 36, CAMP GEIGER AREA DUMP
 REMEDIAL INVESTIGATION, CTO-0303
 MCB, CAMP LEJEUNE, NORTH CAROLINA

QA/QC Sample ⁽¹⁾	Frequency of Collection	Number of Samples	Analytical Parameters
Trip Blanks ⁽²⁾	One per cooler	5	TCL Volatiles
Field Blanks ⁽³⁾	One per event	1	TCL VOC, TCL SVOC, TCL Pest/PCB, TAL Metals, TSS, TDS
Equipment Rinsates ⁽⁴⁾	One per day	4	TCL VOC, TCL SVOC, TCL Pest/PCB, TAL Metals, TSS, TDS
Field Duplicates ⁽⁵⁾	10 % of sample frequency	4	TCL VOC, TCL SVOC, TCL Pest/PCB, TAL Metals, TSS, TDS

- Notes:
- (1) QA/QC sample types defined in Section 3.3.8 in text.
 - (2) Trip blanks submitted with coolers which contained samples for volatile analysis. Samples analyzed for TCL Volatiles only.
 - (3) Field blank collected during the groundwater investigation from water source used for decontamination.
 - (4) Equipment rinsates collected from various sampling equipment (e.g., peristaltic pump).
 - (5) Field duplicate samples presented in Appendix J.

TABLE 3-12

**SUMMARY OF SURFACE WATER FIELD PARAMETERS
SITE 36, CAMP GEIGER AREA DUMP
REMEDIAL INVESTIGATION, CTO-0303
MCB, CAMP LEJEUNE, NORTH CAROLINA**

Station	Temperature (deg. C)	pH (S.U.)	Dissolved Oxygen (mg/L)	Conductivity (micromhos/cm)	Salinity (ppt)
Site 36 Stations					
36-SW/SD01	18.8	9.5	6.3	1287*	0.75*
36-SW/SD02	20	7.0	4.5	596	0
36-SW/SD03	21.9	6.8	2.4	518	0
36-SW/SD04	24	7.7	10.1	610	0
36-SW/SD05	23.0-25.0	8.2-8.8	12.0-18.0**	1,044-3,320	0.6-1.2
36-SW/SD06	23.3-25.3	7.6-8.8	10.3-17.9**	703-1,700	0.4-1.0
36-SW/SD07	19.2-24.7	7.4-8.4	6.9-18.6**	570-886	0.2-0.8
Upstream Stations					
35-SW/SD01	18.2	7.4	8.8	506	0
35-SW/SD02	17.8-19.7	7.3-7.4	8.9-9.8	282-489	0
35-SW03	17.3-21.0	7.3	8.1-8.2	510-572	0-0.1
35-SW/SD04	16.7-19.4	7.0-7.2	5.1-7.8	269-583	0
35-SW/SD05	16.5-18.0	7.2-7.3	7.8-7.9	450-500	0-0.1
35-SW/SD06	17.7-19.5	7.3	4.7-11.0	541-670	0-0.1
35-SW/SD07	19.2-21.9	7.1-7.3	5.4-7.5	291-505	0-0.2

Notes:

* Possible instrument malfunction, station is not tidally influenced.

** Possible instrument malfunction, it is unlikely that the DO would be greater than 17 mg/L.

ppt - parts per thousand

S.U. - Standard Units

NA - Not Analyzed

SW/SD - Surface water/sediment sample

°C - Degrees Centigrade

mg/L - Milligrams per Liter

TABLE 3-13

**SURFACE WATER AND SEDIMENT SAMPLING SUMMARY
SITE 36, CAMP GEIGER AREA DUMP
REMEDIAL INVESTIGATION, CTO-0303
MCB, CAMP LEJEUNE, NORTH CAROLINA**

Sample Location	Sample Matrix	Sample Depth ⁽¹⁾	Analytical Parameters							
			TCL Organics	Dissolved TAL Metals	TAL Metals	Water Hardness	Grain Size	TOC	Duplicate Sample	MS/MSD
36-SW/SD01	SW	NA	X	X	X	X				
	SD	0-6"	X		X		X	X	X	X
36-SW/SD02	SW	NA	X	X	X	X				
	SD	0-6"	X		X		X	X		
	SD	6-12"	X		X			X		
36-SW/SD03	SW	NA	X	X	X	X				
	SD	0-6"	X		X		X	X	X	
	SD	6-12"	X		X			X		
36-SW/SD04	SW	NA	X	X	X	X				
	SD	0-6"	X		X		X	X		
	SD	6-12"	X		X			X		
36-SW/SD05	SW	NA	X	X	X	X				
	SD	0-6"	X		X		X	X		
	SD	6-12"	X		X			X		
36-SW/SD06	SW	NA	X	X	X	X	X			
	SD	0-6"	X		X			X	X	X
	SD	6-12"	X		X			X		
36-SW/SD07	SW	NA	X	X	X	X				
	SD	0-6"	X		X		X	X		
	SD	6-12"	X		X			X		
36-SD08	SD	0-6"			X					
36-SD09	SD	0-6"			X					

Notes:

⁽¹⁾NA - Not applicable for surface water samples.

SW - Surface Water

SD - Sediment

TCL - TCL organics include volatiles, semivolatiles, pesticides, and PCBs.

TOC - Total organic carbon

TABLE 3-14

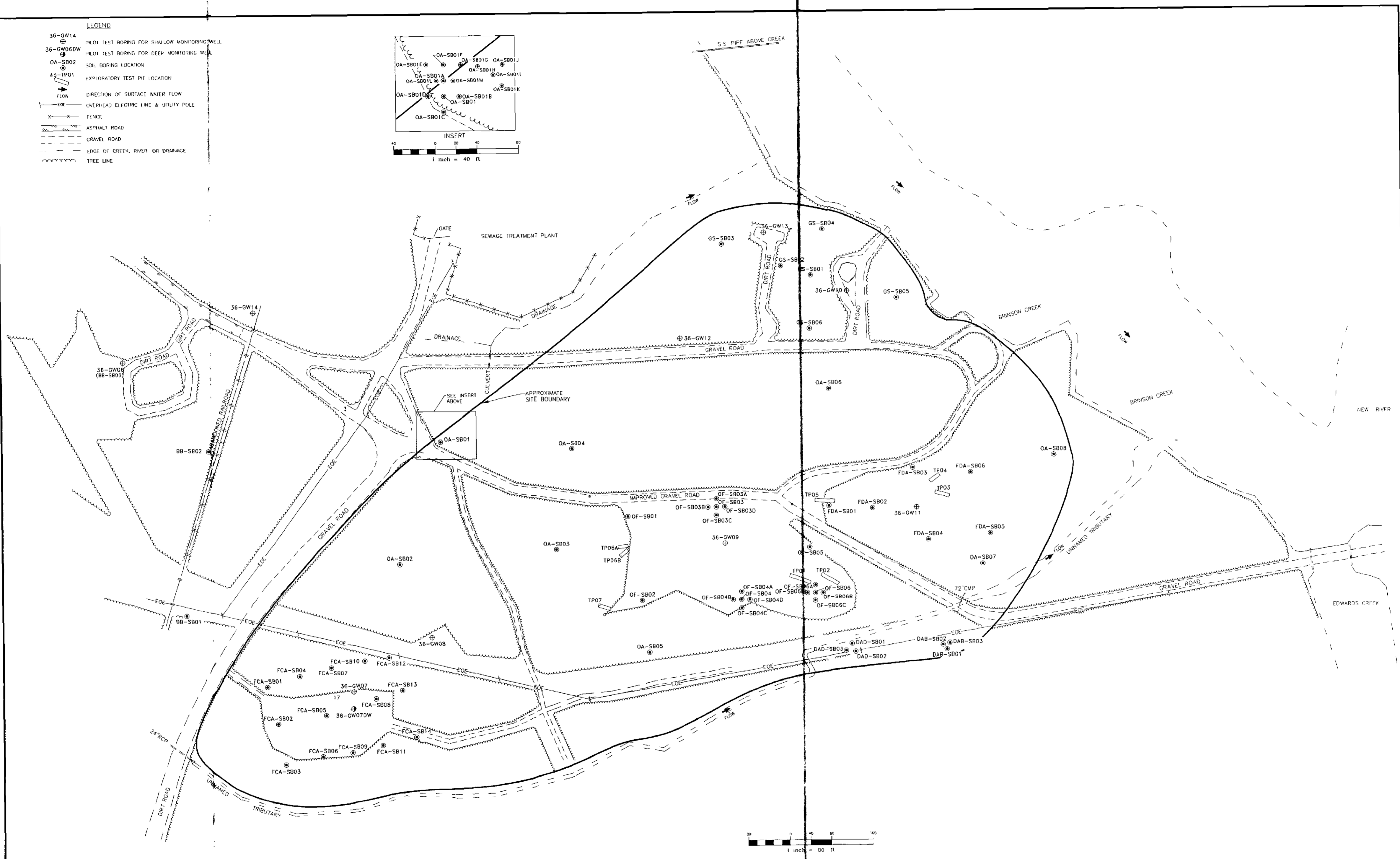
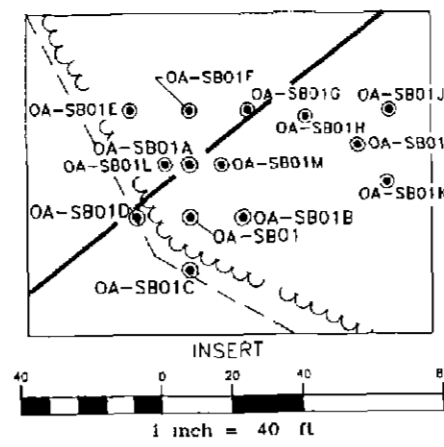
QUALITY ASSURANCE/QUALITY CONTROL SAMPLING PROGRAM
 SURFACE WATER AND SEDIMENT INVESTIGATION
 SITE 36, CAMP GEIGER AREA DUMP
 REMEDIAL INVESTIGATION, CTO-0303
 MCB, CAMP LEJEUNE, NORTH CAROLINA

QA/QC Sample ⁽¹⁾	Frequency of Collection	Number of Samples	Analytical Parameters
Trip Blanks ⁽²⁾	One per cooler	2	TCL Volatiles
Field Blanks ⁽³⁾	One per event	--	--
Equipment Rinsates ⁽⁴⁾	One per day	1	TCL VOC, TCL SVOC, TCL Pest/PCB, and TAL Metals
Field Duplicates ⁽⁵⁾	10% of sample frequency	3	TCL VOC, TCL SVOC, TCL Pest/PCB, and TAL Metals

- Notes:
- (1) QA/QC sample types defined in Section 3.4.4 in text.
 - (2) Trip blanks submitted with coolers which contained samples for volatile analysis. Samples analyzed for TCL Volatiles only.
 - (3) Field blank not collected during surface water and sediment investigation.
 - (4) Equipment rinsates collected from various sampling equipment (e.g., sediment corer).
 - (5) Field duplicate samples presented in Appendix J.

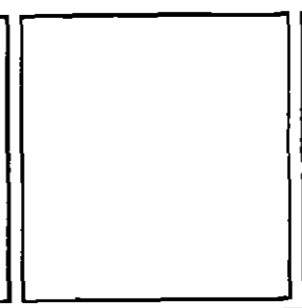
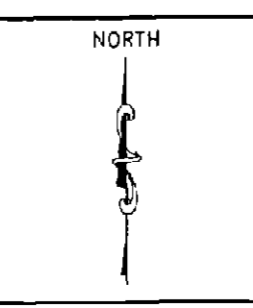
SECTION 3.0 FIGURES

- LEGEND**
- 36-GW14 PILOT TEST BORING FOR SHALLOW MONITORING WELL
 - 36-GW06DW PILOT TEST BORING FOR DEEP MONITORING WELL
 - OA-SB02 SOIL BORING LOCATION
 - 43-TP01 EXPLORATORY TEST PIT LOCATION
 - FLOW DIRECTION OF SURFACE WATER FLOW
 - EOE OVERHEAD ELECTRIC LINE & UTILITY POLE
 - X-X FENCE
 - ASPHALT ROAD
 - GRAVEL ROAD
 - EDGE OF CREEK, RIVER OR DRAINAGE
 - TREE LINE



REVISIONS	

DRAWN	REL
REVIEWED	TFT/JEZ
S.O.#	62470-303
CADD#	303024R1



REMEDIAL INVESTIGATION, CTO-0303
MARINE CORPS BASE, CAMP LEJEUNE
NORTH CAROLINA

BAKER ENVIRONMENTAL, Inc.
Coraopolis, Pennsylvania

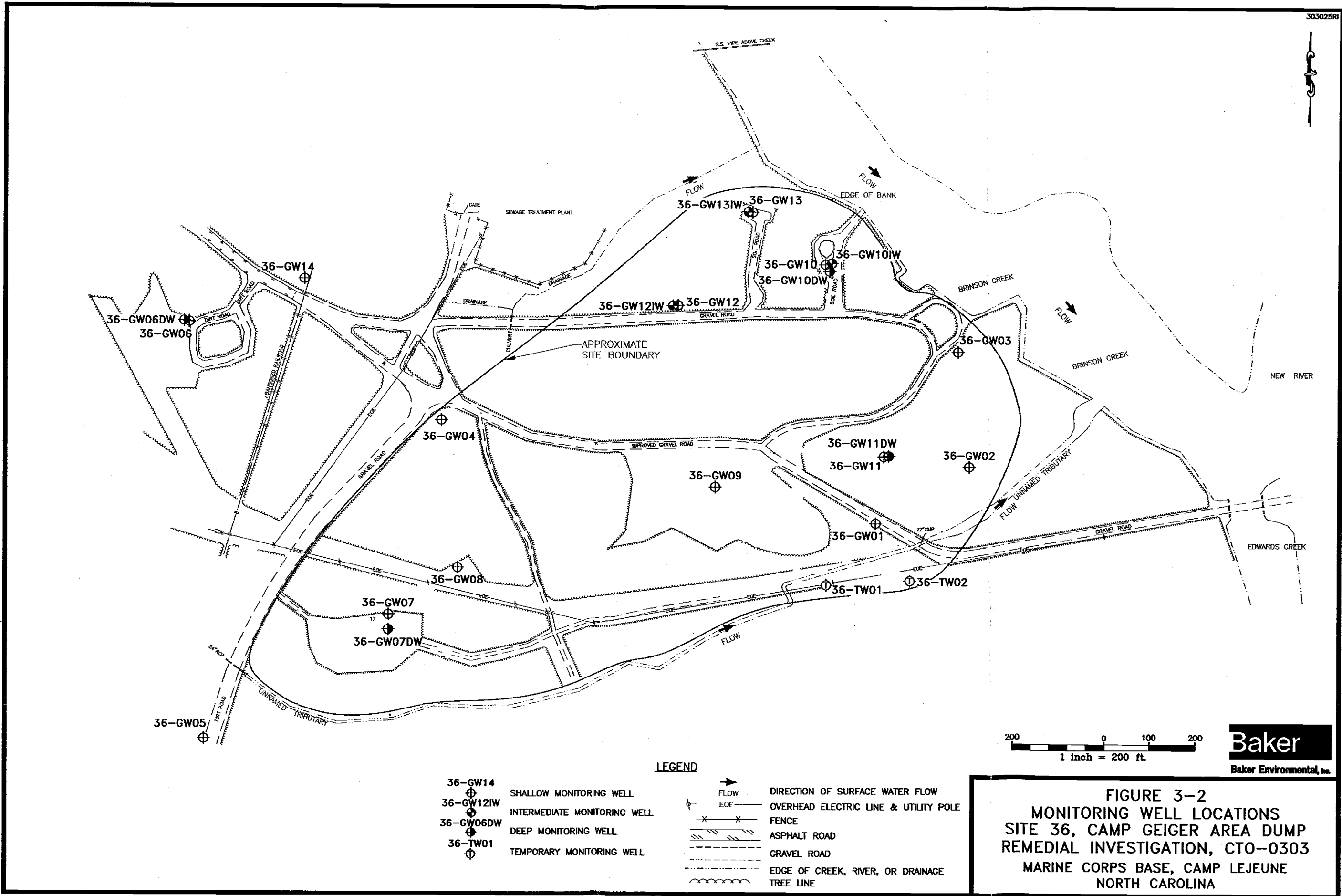


SURFACE AND SUBSURFACE SOIL SAMPLING LOCATIONS	
SITE 36, CAMP GEIGER AREA DUMP	
SCALE	1 = 80'
DATE	JANUARY 1996

FIGURE No.
3-1

01710402X

DATE PLOTTED: 1/23/96
 DRAWN BY: J. L. HARRIS
 CHECKED BY: J. L. HARRIS
 DATE: 1/23/96



- 36-GW14 SHALLOW MONITORING WELL
- 36-GW12IW INTERMEDIATE MONITORING WELL
- 36-GW06DW DEEP MONITORING WELL
- 36-TW01 TEMPORARY MONITORING WELL

LEGEND

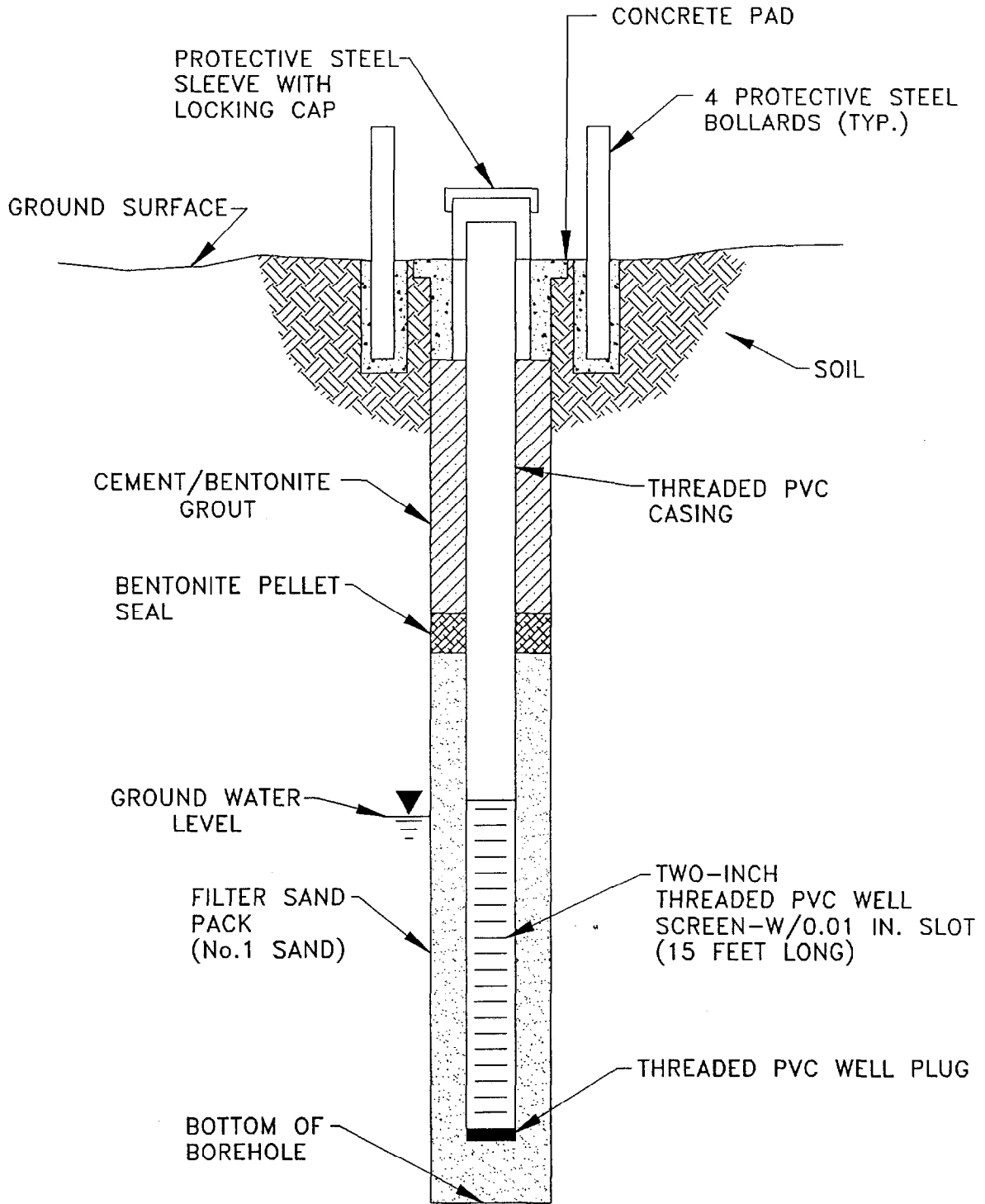
- FLOW DIRECTION OF SURFACE WATER FLOW
- O/E OVERHEAD ELECTRIC LINE & UTILITY POLE
- x-x- FENCE
- ==== ASPHALT ROAD
- GRAVEL ROAD
- - - - EDGE OF CREEK, RIVER, OR DRAINAGE
- ~~~~~ TREE LINE

200 0 100 200
1 inch = 200 ft.

Baker
Baker Environmental, Inc.

FIGURE 3-2
MONITORING WELL LOCATIONS
SITE 36, CAMP GEIGER AREA DUMP
REMEDIAL INVESTIGATION, CTO-0303
MARINE CORPS BASE, CAMP LEJEUNE
NORTH CAROLINA

01710403Z

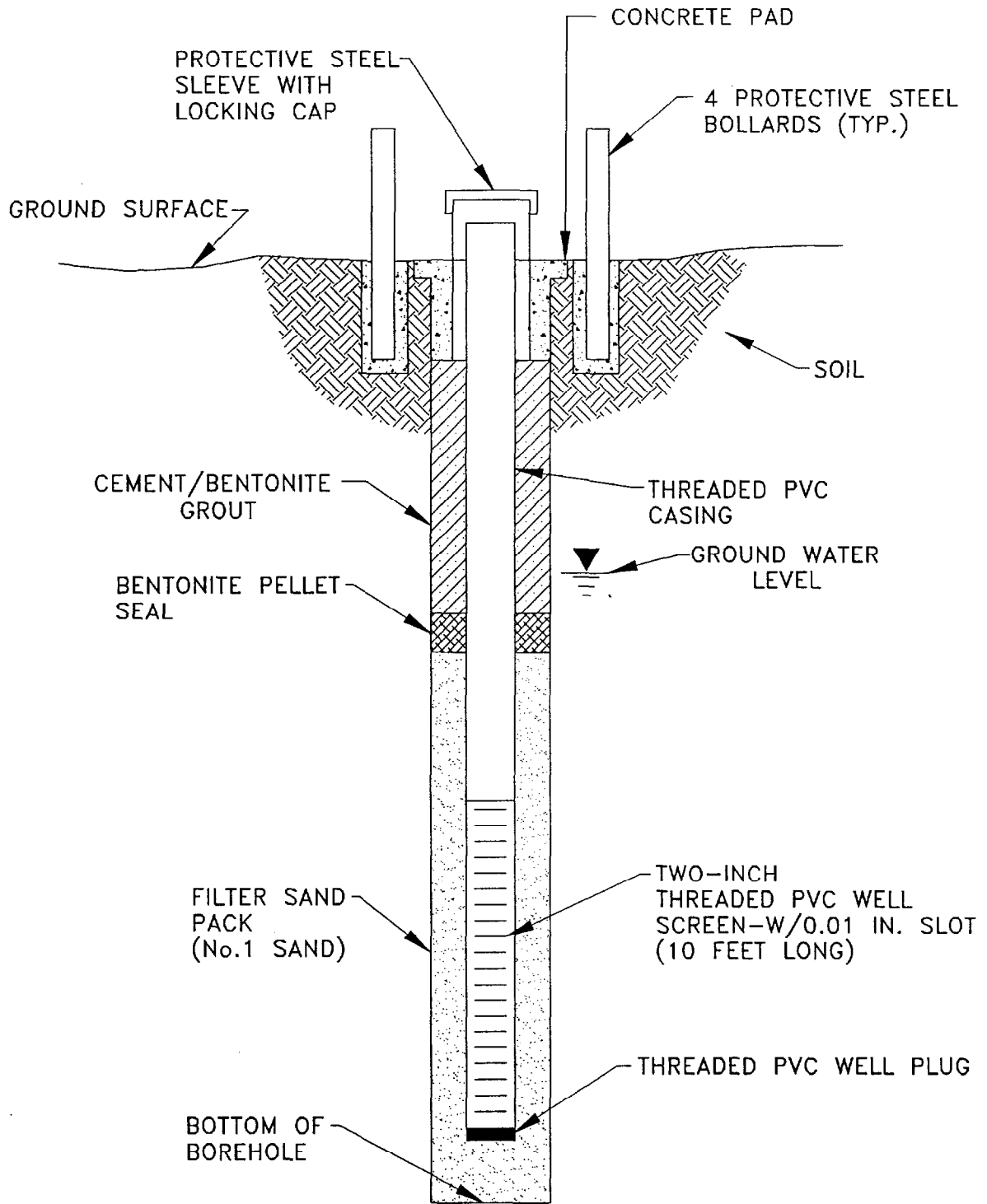


N.T.S.



FIGURE 3-3
TYPICAL SHALLOW TYPE II GROUNDWATER
MONITORING WELL CONSTRUCTION DIAGRAM
REMEDIAL INVESTIGATION CTO-0303

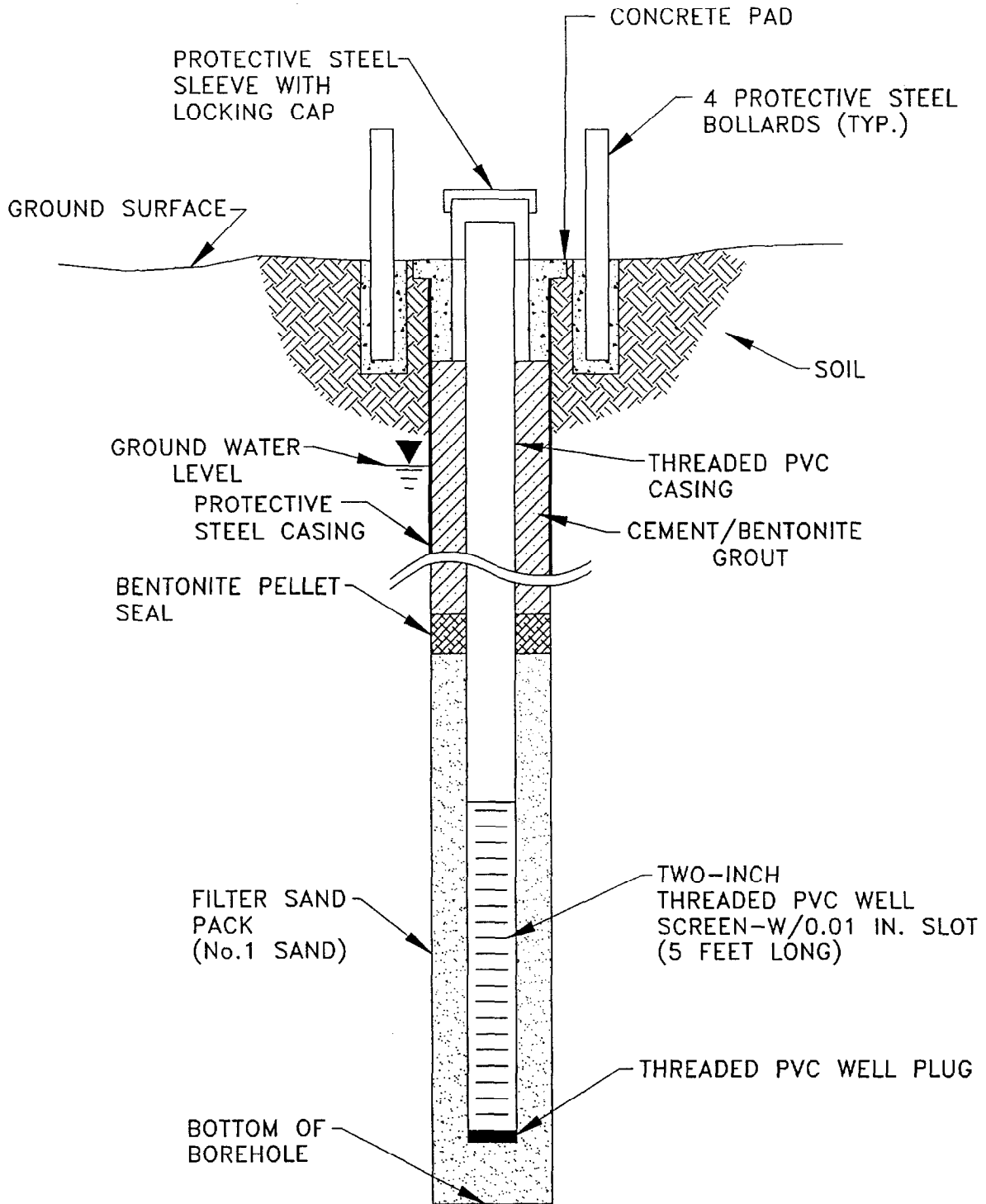
MARINE CORPS BASE, CAMP LEJEUNE
NORTH CAROLINA



N.T.S.



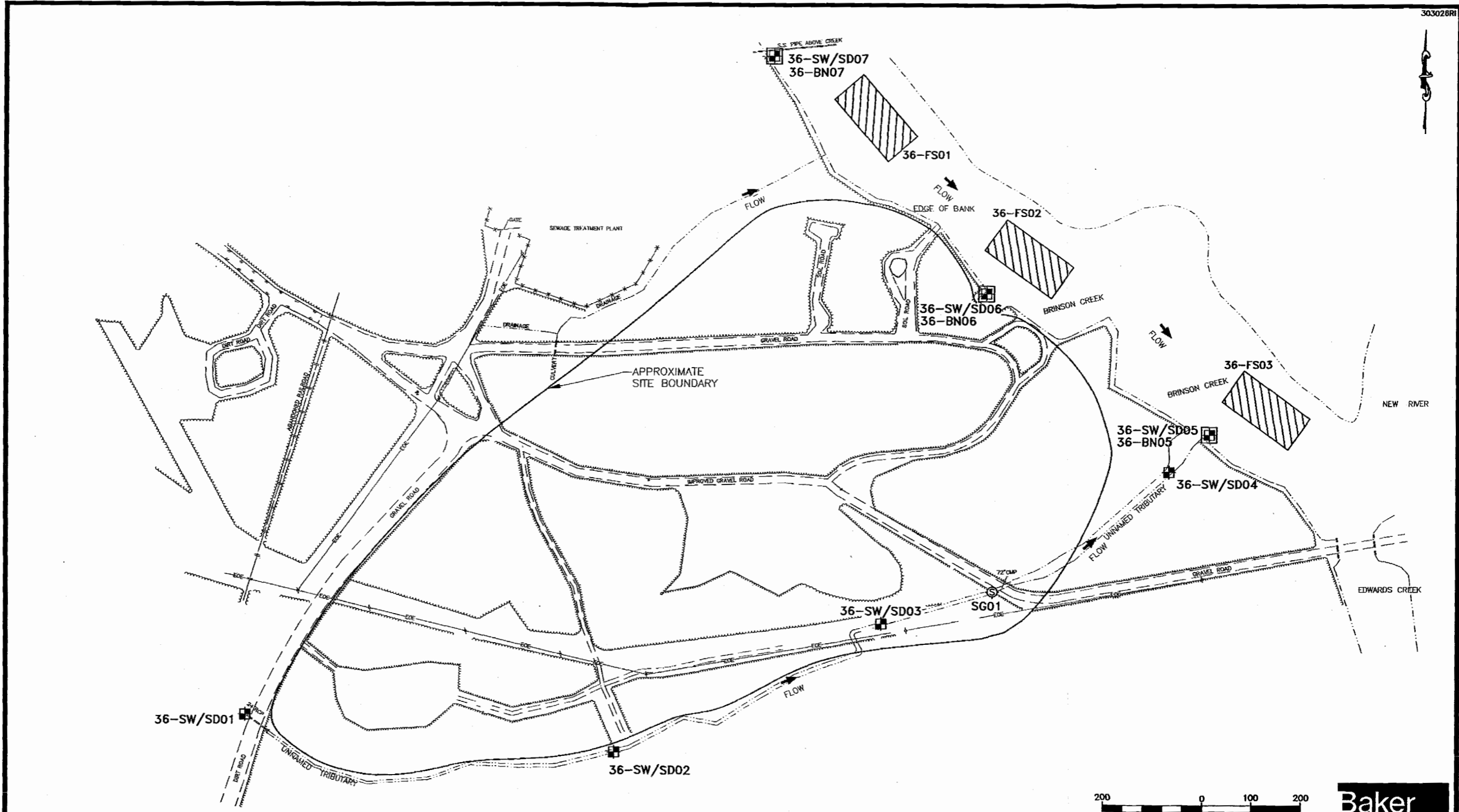
FIGURE 3-4
TYPICAL INTERMEDIATE TYPE II GROUNDWATER
MONITORING WELL CONSTRUCTION DIAGRAM
REMEDIAL INVESTIGATION CTO-0303
MARINE CORPS BASE, CAMP LEJEUNE
NORTH CAROLINA



N.T.S.

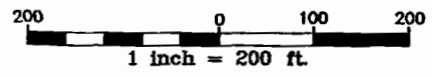


FIGURE 3-5
TYPICAL DEEP TYPE III GROUNDWATER
MONITORING WELL CONSTRUCTION DIAGRAM
REMEDIAL INVESTIGATION CTO-0303
MARINE CORPS BASE, CAMP LEJEUNE
NORTH CAROLINA



- LEGEND**
- 36-SW/SD01 SURFACE WATER AND SEDIMENT SAMPLE LOCATION
 - 36-SW/SD05 SURFACE WATER, SEDIMENT, AND BENTHIC SAMPLE LOCATIONS
 - 36-BN05
 - SG01 STAFF GAUGE LOCATION
 - 36-FS01 AQUATIC ORGANISM SAMPLING LOCATION

- FLOW DIRECTION OF SURFACE WATER FLOW
- X — X — OVERHEAD ELECTRIC LINE & UTILITY POLE
- X — X — FENCE
- / — / — ASPHALT ROAD
- - - - - GRAVEL ROAD
- ~ ~ ~ ~ EDGE OF CREEK, RIVER, OR DRAINAGE
- () — () — TREE LINE



Baker
Baker Environmental, Inc.

FIGURE 3-6
SURFACE WATER, SEDIMENT, AND
AQUATIC SAMPLING LOCATIONS
SITE 36, CAMP GEIGER AREA DUMP
REMEDIAL INVESTIGATION, CTO-0303
MARINE CORPS BASE, CAMP LEJEUNE
NORTH CAROLINA

01710404Z

4.0 NATURE AND EXTENT OF CONTAMINATION

This section presents the nature and extent of contamination at OU No. 6, Site 36. The objective of this section is to characterize the nature and extent of any contamination which may be present as a result of past waste management activities. The characterization of contaminants at Site 36 was performed by sampling and laboratory analysis of soil, groundwater, surface water, sediment, and biota environmental media. Appendices G through M present the Sampling Summaries; Data and Frequency Summaries; Statistical Summaries; Field Duplicate Summaries; Quality Assurance and Quality Control Summaries; TCLP and RCRA Results; and Engineering Parameter Results for the various media at Site 36.

4.1 Data Quality

The majority of data generated during the RI was submitted for third-party validation; wet chemistry, TCLP, RCRA, grain size, and permeability results were not validated. The usability of the data was determined by the third party data validator, Heartland Environmental Services, Inc. Procedures stipulated by the National Functional Guidelines for Organic (USEPA, 1991) and Inorganic (USEPA, 1988) Analyses were observed during the validation process. Validation of the analytical data serves to reduce the inherent uncertainties associated with its usability. Data qualified as "J" were retained as estimated. Estimated analytical results within a data set are common and considered to be usable by the USEPA (USEPA, 1989). Data may be qualified as estimated for several reasons including an exceedance of holding times, high or low surrogate recovery or intra-sample variability. In addition, values may be assigned an estimated "J" qualifier if the reported value is below the Contract Required Detection Limit (CRDL) or the Contract Required Quantitation Limit (CRQL). Data assigned a rejected "R" qualifier was excluded from the usable data set. Under these conditions estimated positive results were designated with "J" qualifiers and all rejected data were assigned "R" qualifiers. Table 4-1 provides a summary of all rejected Site 36 data.

Additional qualifiers were employed during the validation of data. The "NJ" qualifier denotes that a compound was tentatively identified, but the reported value may not be accurate or precise. Compounds that were not detected and had inaccurate or imprecise quantitation limits were assigned the "UJ" qualifier.

4.1.1 Data Management and Tracking

The management and tracking of data, from time of field collection to receipt of validation report, is of primary importance to the overall quality of laboratory analytical results. Field samples and their corresponding analyses were recorded on chain-of-custody forms, provided in Appendix D. Chain-of-custody forms were compared to the Field Sampling and Analysis Plan (Baker, 1994); this comparison was used to verify that appropriate laboratory analyses had been requested. Upon receipt of laboratory analytical results, a further comparison was performed to verify that each sample received by the laboratory was analyzed for the correct parameters. Finally, the validation report was compared to the requested laboratory analyses.

The management and tracking of data was used to determine the following items:

- Identify and correct chain-of-custody discrepancies prior to laboratory analysis
- Verify the receipt of all samples by the laboratory

- Confirm that requested sample analyses and validation were performed
- Ensure the delivery of a complete data set

4.2 Non-Site Related Analytical Results

Many of the organic compounds and inorganic analytes detected in environmental media at Site 36 may be attributable to non-site related conditions or activities. Two primary sources of non-site related analytical results include laboratory contaminants and naturally-occurring inorganic species. In addition, non-site related operational activities and conditions may contribute to "on-site" contamination. A discussion of non-site related analytical results for Site 36 is provided in the subsections which follow.

4.2.1 Laboratory Contaminants

Field blank and trip blank samples provide a measure of contamination that has been introduced into a sample set during the collection, transportation, preparation, or analysis of samples. To remove non-site related constituents from further consideration, the concentrations of chemicals detected in blanks were compared with concentrations of the same chemicals detected in environmental samples.

Common laboratory contaminants (i.e., acetone, 2-butanone, chloroform, methylene chloride, toluene, and phthalate esters) were retained for use in interpreting site conditions only when observed concentrations in any environmental sample exceeded ten times the maximum concentration detected in any blank. If the concentration of a common laboratory contaminant was less than ten times the maximum blank concentration, its presence among the data set was attributed to laboratory contamination in that particular sample (USEPA, 1989) and excluded from further evaluation. The maximum concentrations of detected common laboratory contaminants in blanks were as follows:

● Acetone	24 J $\mu\text{g/L}$
● Chloroform	13 $\mu\text{g/L}$
● 2-Butanone	32 $\mu\text{g/L}$
● bis-(2-Ethylhexyl)phthalate	280 J $\mu\text{g/L}$

Blanks containing organic constituents that were not considered common laboratory contaminants (i.e., all other TCL compounds) were retained in the site analytical database only when observed concentrations exceeded five times the maximum concentration detected in any QA/QC blank (USEPA, 1989). All TCL compounds detected at less than five times the maximum level of contamination noted in any QA/QC blank were attributed to blank contamination and excluded from further evaluation. The maximum concentrations of all other detected blank contaminants were as follows:

● Bromodichloromethane	13 $\mu\text{g/L}$
● Dibromochloromethane	10 $\mu\text{g/L}$

A limited number of environmental samples that exhibited high concentrations of tentatively identified compounds (TICs) were subjected to an additional sample preparation. Medium level sample preparation provides a corrected CRQL based on the volume of sample used for analysis. The corrected CRQL produces higher detection limits than the low level sample preparation. A

comparison to laboratory blanks used in the medium level preparation was used to evaluate the relative amount of contamination within these samples.

4.2.2 Naturally-Occurring Inorganic Analytes

In order to differentiate between inorganic contamination due to site operations and naturally-occurring inorganic analytes in site media, the results of the sample analyses were compared to information regarding background conditions at MCB, Camp Lejeune. The following guidelines were used for each media:

Soil:	MCB, Camp Lejeune Background Soil Samples
Groundwater:	MCB, Camp Lejeune Background Groundwater Samples
Surface Water:	MCB, Camp Lejeune Background Surface Water Samples
Sediment:	MCB, Camp Lejeune Background Sediment Samples

The following subsections address the various comparison criteria used to evaluate soil, groundwater, surface water, and sediment analytical results from samples collected at Site 36.

4.2.2.1 Soil

In general, applicable or relevant and appropriate requirements (ARARs) are not available for specific contaminants in soil. As a result, base-specific background concentrations have been compiled from a number of locations throughout MCB, Camp Lejeune to evaluate reference levels of inorganic analytes in the surface and subsurface soil.

Typical background concentration values for inorganic analytes in soils at MCB, Camp Lejeune are presented in Appendix P. These ranges are based on analytical results of background samples collected in areas not known to have been impacted by operations or disposal activities adjacent to Sites 1, 2, 6, 7, 16, 28, 30, 35, 36, 41, 43, 44, 54, 69, 74, 78, 80, and 86 (refer to Figure 1-2 for site locations throughout MCB, Camp Lejeune). Subsequent discussions of the analytical results from samples collected during the soil investigation only consider those inorganic analytes with concentrations exceeding twice the average base-specific background concentration, as recommended by USEPA Region IV.

In general, background soil samples have been collected outside the known boundaries of those sites listed above in areas with similar soil types. According to the Soil Conservation Service (SCS) Soil Survey, the greatest portion of MCB, Camp Lejeune is underlain by a number of similar soil units. Soils found on this portion of the coastal plain are moderately to strongly acidic in nature and are classified under the USCS as SM, SM-SP (i.e., fine sand or loamy fine sand). Section 3.0 provides the locations of background soil borings completed at Site 36 during this investigation.

4.2.2.2 Groundwater

Chemical-specific ARARs are available for evaluation of analytical results from groundwater samples. In the subsequent sections which address the analytical results of samples collected during the groundwater investigation, only those inorganic parameters with concentrations exceeding applicable state or federal regulations will be discussed.

Groundwater samples were analyzed for total inorganic parameters. In addition, a limited number of selected groundwater samples were submitted for dissolved (i.e., "filtered") inorganic analyses. Concentrations of dissolved inorganics were found to be generally lower than total inorganic concentrations, particularly for metals such as chromium, iron, lead, and manganese. A 0.45-micron filter was used in the field to remove small particles of silt and clay that would otherwise be dissolved during sample preservation, resulting in higher concentrations of inorganic analytes. The total metal analyses from unfiltered samples is considered to reflect the concentrations of inorganics in the natural lithology and inorganic analytes dissolved in the groundwater.

Higher concentrations of certain metals in unfiltered groundwater samples collected at MCB, Camp Lejeune are not considered atypical based on experience gained during other studies. The difference between the two analytical results (i.e., total and filtered) is important in terms of understanding and separating naturally-occurring elements (e.g., lead) from contamination by site operations (e.g., lead in gasoline). An evaluation report which pertains to naturally occurring metals in groundwater at MCB, Camp Lejeune is provided in Appendix P.

USEPA Region IV requires that unfiltered inorganic concentrations be used in evaluating ARARs and risk to human health and the environment. In the subsequent sections, which discuss the groundwater sample analytical results, both total and dissolved inorganics (which exceed applicable state or federal limits) will be presented and discussed for comparison purposes.

Groundwater in the MCB, Camp Lejeune area is naturally rich in iron and manganese. Iron and manganese concentrations, both for total and filtered samples, in groundwater at MCB, Camp Lejeune often exceed the North Carolina Water Quality Standards (NCWQS) of 300 and 50 µg/L, respectively. Elevated levels of iron and manganese, at concentrations above the NCWQS, were reported in samples collected from a number of base potable water supply wells which are installed at depths greater than 162 feet below ground surface (Greenhorne and O'Mara, 1992). Iron and manganese concentrations from several wells at Site 36 exceeded the NCWQS but fell within the range of concentrations for samples collected elsewhere at MCB, Camp Lejeune. There is no record of any historical use of iron or manganese at Site 36. In light of this, it is assumed that iron and manganese are naturally-occurring inorganic analytes in groundwater, and their presence is not attributable to site operations.

4.2.2.3 Surface Water

In the sections which address the analytical results of samples collected during the surface water investigation, only those inorganic parameters with concentrations exceeding applicable state or federal regulatory limits will be discussed. Base-specific background concentrations have been compiled from a number of locations throughout MCB, Camp Lejeune to supplement the evaluation of detected inorganic analytes in surface water. Typical inorganic background concentration values for surface waters at MCB, Camp Lejeune are presented in Appendix P. These values are based on analytical results of background samples collected upgradient of areas known or suspected to have been impacted by operations or disposal activities. Inorganic parameters detected below these levels are assumed to be naturally-occurring elements.

4.2.2.4 Sediment

Base-specific inorganic background concentrations have been compiled from a number of locations throughout MCB, Camp Lejeune to supplement the evaluation of detected inorganic analytes in

sediment. Those inorganic analytes that exceed applicable state or federal regulatory limits are compared to base-specific background concentrations in subsequent sections. Typical inorganic background concentration values for sediments at MCB, Camp Lejeune are presented in Appendix P. These values are based on analytical results of background samples collected upgradient of areas known or suspected to have been impacted by operations or disposal activities. Inorganic parameters detected below these levels are assumed to be naturally-occurring elements.

4.3 Analytical Results

This section presents the results of the soil, groundwater, surface water, and sediment investigations performed at Site 36. A summary of site contamination, by media, is provided in Table 4-2.

4.3.1 Soil Investigation

Unique sample notations were employed to identify soil sampling locations and sample depths at Site 36. Samples designated by "FCA," "FDA," "OA," and "OF" were collected from specific portions of the site (as described in Section 3.0). Samples designated with the prefix "GW" were collected from monitoring well pilot test borings. The suffix "DW" after the monitoring well number indicates that the sample was obtained from a deep monitoring well test boring. The following suffix designations refer to the depth at which a sample was obtained:

00	-	ground surface to 12 inches bgs
01	-	1 to 3 feet bgs
02	-	3 to 5 feet bgs
03	-	5 to 7 feet bgs
04	-	7 to 9 feet bgs
05	-	9 to 11 feet bgs

Surface soil positive detection summaries for organic compounds and inorganic analytes are presented in Tables 4-3 and 4-4. Positive detection summaries of organic compounds in subsurface soils are presented in Table 4-5; summaries for inorganic analytes are provided in Table 4-6. The majority of soil samples collected at Site 36 were analyzed for full TCL organics and TAL inorganics using CLP protocols and Level IV data quality (refer to Section 3.0). Soil samples obtained from monitoring well test borings were also analyzed for full TCL organics and TAL inorganics. In addition, a limited number of soil samples underwent analyses for total petroleum hydrocarbons (TPH).

4.3.1.1 Surface Soil

A total of 66 surface soil samples were collected at Site 36; 52 of the 66 samples were analyzed for full TCL organics and TAL inorganics; 6 samples were submitted for TCL volatile and semivolatile analyses only; 5 samples were submitted for TCL pesticides and PCBs only; and 3 samples were analyzed for TCL volatiles only. As indicated in Table 4-2, volatile, semivolatile, pesticide, and PCB organic compounds were detected in surface soils at Site 36.

The volatile compounds trichloroethene, tetrachloroethene, toluene, styrene, and total xylenes were detected among 9 of the 61 surface soils samples submitted for these analyses. Positive VOC detections primarily were in samples obtained from the north and south-central portions of the study

area. As presented on Table 4-2, concentrations of VOCs in surface soil ranged from 2 µg/kg of tetrachloroethene to 98 µg/kg of toluene.

A total of 20 semivolatile compounds were detected among 11 of the 57 surface soil samples. A majority of positive SVOC detections were within soil samples obtained from the southeastern portion of the study area. Fifteen of the 20 semivolatile contaminants detected were polynuclear aromatic hydrocarbons (PAHs). Semivolatile concentrations ranged from 40 µg/kg of benzo(a)pyrene to 11,000 µg/kg of pyrene. Fluoranthene, pyrene, and chrysene were detected the most frequently, among SVOCs. As presented in Table 4-2, each of the 15 PAH compounds were detected at maximum concentrations within a surface soil sample obtained from the test boring OF-SB04. Four confirmatory surface samples were obtained from an area immediately surrounding OF-SB04 in May 1996. As provided in Table 4-3, the unvalidated results confirm the presence of PAH compounds at this location.

Pesticides were detected in 52 of the 57 surface soil samples submitted for analyses from Site 36. Unlike the SVOC detections, pesticides were widely scattered at varying concentrations throughout the site. As indicated in Table 4-2, 4,4'-DDE, 4,4'-DDT, 4,4'-DDD, and dieldrin (in decreasing order of frequency) were the most prevalent among the 15 pesticide contaminants detected, each with at least 21 positive detections. Pesticide concentrations ranged from 1.2 µg/kg of alpha-chlordane and gamma-chlordane to 16,000 µg/kg of dieldrin. Test borings OA-SB01A, OA-SB05, and OF-SB03 each had three of the maximum pesticide concentrations.

Two polychlorinated biphenyls (PCBs) were detected within a 30-foot diameter area surrounding test boring OA-SB01, located near the western site boundary. Nine of the ten soil borings surrounding test boring OA-SB01 had detections of Aroclor-1248 at concentrations ranging from 68 to 24,000 µg/kg. Aroclor-1254 was detected at three separate locations with concentrations ranging from 92 to 530 µg/kg. No other surface soil samples had detectable concentrations of PCBs.

Confirmatory samples were also obtained from the areas adjacent to borings OA-SB01 and OF-SB03 during May 1996. The results suggest that elevated pesticide detections, similar to those pesticides verified during the initial sampling event, do not extend outward from the suspect locations. Two additional surface samples were also retained for PCB analyses. The unvalidated results of those analyses, coupled with existing analytical data, imply that the presence of PCBs may not be limited to the current group of sampling locations that surround OA-SB01. Although the occurrence of PCBs may not be restricted to the existing sampling locations, concentrations of both Aroclor-1248 and Aroclor-1254 tend to have decreased with distance. Unvalidated results from the May 1996 supplemental event are presented in Table 4-3.

Twenty-two of 23 possible TAL inorganics were detected among the 52 surface soil samples collected at Site 36 (beryllium was not detected in any of the 52 samples). Table 4-2 provides a summary of the priority pollutant inorganic analytes found within soil samples at Site 36. Priority pollutant metals are a subset of TAL metals which include antimony, arsenic, beryllium, cadmium, chromium, copper, lead, mercury, nickel, selenium, silver, thallium, and zinc. Antimony, arsenic, chromium, copper, lead, mercury, nickel, silver, and zinc were each detected at concentrations exceeding twice their average base-specific background levels (refer to Appendix P for base-specific inorganic background concentrations). Five positive detections of copper, lead, and mercury were found, among all surface samples, at concentrations greater than one order of magnitude above twice their average base-specific background level. Zinc was detected at concentrations greater than one order of magnitude above twice the average base-specific background level in eleven surface soil

samples retained from Site 36. Although inorganics were detected in soil samples collected throughout the site, consistently higher concentrations of metals were identified in samples collected from the eastern portion of the study area.

4.3.1.2 Subsurface Soil

A total of 67 subsurface (i.e., collected at depths greater than one-foot bgs) soil samples from Site 36 were submitted for laboratory analyses; 53 of the 65 samples were analyzed for full TCL organics and TAL inorganics; 6 samples were submitted for TCL volatile and semivolatile analyses only; 5 samples were submitted for TCL pesticides and PCBs only; and 3 samples were analyzed for TCL volatiles only. The results indicate the presence of organic compounds and inorganic analytes.

Acetone, 1,2-dichloroethene (total), trichloroethene, benzene, toluene, and total xylenes were detected at least once among the samples submitted for analyses from Site 36 (refer to Table 4-2). Positive VOC detections ranged from 2 µg/kg of total xylenes to 480 µg/kg of acetone, which exceeded 10 times the level of acetone found in investigation blanks. The majority of subsurface VOC detections were observed in samples obtained from the eastern (i.e., the former disposal area), southeastern (i.e., drum/container area), northern, and central portions of the study area.

Eighteen semivolatile organic compounds were detected among 12 of 57 subsurface soil samples obtained from Site 36. With the exception of two soil borings, all semivolatile compounds were detected within soil samples collected from portions of the site that corresponded to positive VOC detections. Eleven of the 15 SVOCs detected were PAHs. Semivolatile concentrations ranged from 41 µg/kg of naphthalene and chrysene to 2,100 µg/kg of isophorone in sample DAB-SB01. As provided in Table 4-2, 9 of the 11 PAH compounds were detected at maximum concentrations within a subsurface soil sample obtained from boring OA-SB07, located within the former disposal area. The PAHs pyrene and chrysene were detected the most frequently, each detected in at least 5 of 57 subsurface soil samples.

Twelve pesticide compounds were detected in subsurface soils at Site 36. Positive detections of pesticides were more prevalent in subsurface soils obtained from the eastern portion of the study area. In general, concentrations of pesticides were higher in samples obtained from the former disposal area and the area surrounding test boring OA-SB01. As depicted in Table 4-2, pesticide concentrations ranged from 1.5 µg/kg of aldrin to 3,100 µg/kg of 4,4'-DDT in sample OA-SB01A.

Aroclor-1248 was detected in five subsurface soil samples from the area surrounding OA-SB01; the same location where positive PCB detections in the surface soil were observed. Aroclor-1248 was detected at concentrations ranging from 19 to 850 µg/kg in sample OA-SB01. Aroclor-1254 was not detected any of the subsurface samples, unlike one surface sample obtained from the same area.

Twenty-two of 23 TAL inorganics were detected in subsurface soils at Site 36 (thallium was not detected). As presented in Table 4-2, antimony, arsenic, cadmium, chromium, copper, lead, mercury, nickel, selenium, and zinc were each detected at concentrations exceeding twice the average base-specific background levels. Arsenic, cadmium, mercury, and nickel were found in samples at concentrations greater than one order of magnitude above twice their average base-specific background levels for subsurface soil (refer to Appendix P for base-specific inorganic background concentrations). Additionally, copper, lead, and zinc were observed at concentrations greater than two orders of magnitude above twice their respective average base-specific background

levels. As with surface soils, inorganics were detected at consistently higher concentrations in subsurface samples obtained from the eastern, southeastern, and central portions of Site 36.

4.3.1.3 Summary

VOCs and SVOCs detected in soil samples at Site 36 appear to be the most directly linked, among organic compounds, to past disposal practices. Several SVOCs were identified in both surface and subsurface soil samples obtained primarily from the eastern, southeastern, and central portions of the study area. A majority of SVOCs detected in soil samples were PAH compounds, which probably resulted from combustion of waste material or refuse. As provided in Table 4-2, several of the SVOCs were detected at concentrations greater than 1,000 µg/kg.

Inorganic analytes were detected in both surface and subsurface soil samples from the eastern portion of the study area at concentrations greater than one order of magnitude above twice the average base-specific background levels. In general, elevated metal concentrations were limited to soils obtained from the eastern, southeastern, and central portions of the study area. Copper, lead, and zinc were observed at maximum concentrations greater than two orders of magnitude above twice their average base-specific background levels. The same three metals had several positive detections in excess of the one order of magnitude level.

Dieldrin, 4,4'-DDE, 4,4'-DDD, and 4,4'-DDT appear to be the most widely scattered pesticides within soils at Site 36. Each of the four pesticides was detected in at least 35 of 103 soil samples. The pesticide 4,4'-DDE was the most prevalent, with 72 positive detections at concentrations ranging from 2.2 to 2,600 µg/kg in surface soil. The highest pesticide concentration was that of dieldrin in a surface soil sample at 16,000 µg/kg. In general, higher concentrations of those pesticides more frequently detected, were limited to the eastern and central portions of the study area, and in particular among borings 36-GW11, OA-SB05, and FDA-SB05. A number of maximum pesticide detections were also observed in samples from the western portion of the site, immediately surrounding OA-SB01.

Two PCBs, Aroclor-1248 and 1254, were detected in 14 soil samples obtained within a 30-foot diameter area surrounding OA-SB01 at Site 36. The maximum Aroclor-1248 concentration was 24,000 µg/kg in sample OA-SB01I. Two other PCB detections of Aroclor 1254 were observed in surface samples obtained from the central portion of the site.

Volatile compounds were found in surface and subsurface samples at concentrations generally lower than 20 µg/kg. Based upon their detection within areas reported or suspected of receiving waste and the number of years since disposal operations reportedly transpired, the occurrence of volatile compounds in soils at Site 36 appears to be the result of past disposal practices in specific portions of the study area. In general, volatile, semivolatile, and higher pesticide concentrations were observed in similar areas of the site.

4.3.2 **Groundwater Investigation**

The groundwater investigation at Site 36 included the collection of 23 groundwater samples obtained from two temporary, fourteen shallow, three intermediate, and four deep monitoring wells. Seventeen of the 23 groundwater samples collected at Site 36 were analyzed for full TCL organics and TAL total inorganics using CLP protocols and Level III data quality. Pesticide and PCB analyses were not requested for the additional three shallow and three intermediate monitoring wells

installed during supplemental RI activities. In addition, four of the groundwater samples were submitted for dissolved TAL metal analyses. (Dissolved or filtered TAL inorganic results are presented in this report for quantitative comparison purposes only. These results were not used to evaluate site-related risks or to determine compliance with groundwater standards.)

Round one groundwater samples were collected from five existing shallow wells (36-GW01 through 36-GW05), the six newly installed shallow wells (36-GW06 through 36-GW11), two temporary wells (36-TW01 and 36-TW02), and the three newly installed deep wells (36-GW06DW, 36-GW07DW, and 36-GW11DW) at Site 36. Based upon the analytical results generated during the initial phase of groundwater sampling activities, an additional three shallow (36-GW12, 36-GW13, and 36-GW14) and three intermediate monitoring wells (36-GW10IW, 36-GW12IW, and 36-GW13IW) were installed in the northern portion of the study area during the latter phase of RI sampling activities.

A second, supplemental, round of groundwater sampling was performed in July of 1995 that included the sampling of one newly installed deep monitoring well (36-GW10DW) and the resampling of the supplemental shallow and intermediate monitoring wells. The second round was conducted to confirm the presence of VOCs detected in samples obtained in the northern portion of the study area. The analytical results from both sampling rounds are discussed in subsequent sections. A positive detection summary of organic compounds from the first sampling round is provided in Table 4-7. Total and dissolved metal results from the first sampling round are presented in Tables 4-8 and 4-9, respectively. Organic compounds detected in samples acquired during the second sampling round are presented in Table 4-10. Inorganic analyses were not requested during the second sampling round.

4.3.2.1 Shallow Groundwater

Groundwater conditions within the upper and lower portions of the surficial aquifer were evaluated through collection and analysis of samples from both shallow and intermediate monitoring wells (refer to Section 3.0 and Appendix B for well construction details).

Round One

A total of 16 shallow and 3 intermediate groundwater samples from Site 36 were submitted for laboratory analysis. The samples were collected from both the upper and lower portions of the surficial aquifer. As indicated in Table 4-7, volatile organic detections were limited to the northern and western portions of the study area. The volatile compounds 1,2-dichloroethene, trichloroethene, and 1,1,2,2-tetrachloroethane were detected during the first sampling round at their respective maximum concentrations of 31, 70 and 10 µg/L within a sample obtained from 36-GW10IW. With the exception of two 1,2-dichloroethene detections in samples from wells 36-GW04 and 36-GW08, volatile detections were limited to the northern portion of the study area. No semivolatile or PCB contaminants were detected in any of the 19 groundwater samples submitted from the shallow aquifer.

4,4'-DDD was detected at a concentration of 0.056 µg/L in one groundwater sample obtained from monitoring well 36-GW10, located in the northern portion of the study area. No other detections of pesticides were observed in any of the groundwater samples obtained from Site 36.

TAL total metals were detected in each of the temporary, shallow, and intermediate monitoring wells at Site 36. Dissolved metals were also detected in each of the four groundwater samples submitted for filtered analysis. Complete positive detection summaries for total and dissolved metals are provided in Tables 4-8 and 4-9. Sixteen of the 23 TAL total metals were detected within at least one groundwater sample at Site 36 (antimony, beryllium, chromium, cobalt, copper, silver, and thallium were not detected). Only ten of 23 TAL metals were detected within at least one of the 4 groundwater samples submitted for dissolved analyses (in addition to the total metals that were not detected; aluminum, cadmium, lead, mercury, selenium, and vanadium were not detected in the samples submitted for dissolved analysis). Iron and manganese were detected with the greatest frequency among groundwater samples and at concentrations in excess of NCWQS levels, as depicted in Table 4-2. Iron exceeded the NCWQS of 300 µg/L in 12 of the 19 groundwater samples obtained from the surficial aquifer, with a maximum concentration of 16,900 µg/L. Manganese was detected at concentrations exceeding the NCWQS of 50 µg/L in groundwater samples from 11 of the 19 surficial aquifer monitoring wells, with a maximum concentration of 3,180 µg/L. Mercury was detected once among the sample set, from temporary well 36-TW02, at a concentration of 1.4 µg/L which slightly exceeded the NCWQS of 1 µg/L.

Round Two

During the second sampling round, groundwater samples from three shallow and three intermediate monitoring wells at Site 36 were submitted for laboratory analysis of TCL organics. A single groundwater sample from 36-GW10 was also submitted for pesticide analysis. The additional analyses were obtained from monitoring wells located in the northern portion of the study, the portion of the site that had exhibited contamination during the first sampling round. Similar levels of volatile organic compounds were detected among groundwater samples submitted for analysis from the second sampling event. No pesticides were detected in the confirmatory groundwater sample obtained from 36-GW10.

As Table 4-10 indicates, methylene chloride, 1,2-dichloroethene, trichloroethene, tetrachloroethene, and 1,1,2,2-tetrachloroethane were detected during the second sampling round at maximum concentrations of 1, 37, 97, 2, and 8 µg/L, respectively. Four of the five VOCs were detected at their respective maximum concentrations in a sample obtained from 36-GW10IW, a similar result to that of the first round. Methylene chloride and tetrachloroethene were not detected during the first sampling round.

4.3.2.2 Deep Groundwater

A total of four groundwater samples were obtained from the deep aquifer at Site 36. Deep monitoring wells were screened at intervals just below the semi-confining unit, into the upper portion of the Castle Hayne aquifer. Volatile, semivolatile, pesticide, and PCB organic compounds were not detected in any of the four samples obtained from the deep aquifer.

TAL total metals were detected in each of the four deep monitoring wells at Site 36. Eleven of the 23 TAL total metals were detected within at least one of the deep groundwater samples. None of the deep aquifer samples were submitted for dissolved metal analyses. Manganese was detected in well 36-GW11DW at a concentration of 84 µg/L that exceeded the NCWQS of 50 µg/L. None of the other TAL total metals that were detected in the deep aquifer exceeded MCL or NCWQS levels.

4.3.2.3 Summary

Inorganics were the most prevalent and widely distributed constituents detected in both shallow and deep groundwater at Site 36. Concentrations of TAL total metals were generally higher in groundwater samples from the shallow aquifer than in samples collected from the deeper aquifer. Iron and manganese were the most prevalent inorganic analytes, detected at concentrations that exceeded state standards within 12 groundwater samples. Table 4-2 presents a summary of inorganic analytes in excess of applicable state standards.

Positive detections of organic compounds were limited to the northern and western portions of the study area. The presence of volatile compounds in the northern portion of the study area, as indicated by the initial round of sampling results, were confirmed by results of the second sampling round. Six positive detections of trichloroethene from four separate monitoring wells exceeded the NCWQS of 5 µg/L. The maximum trichloroethene detection was 97 µg/L from well 36-GW10IW collected during the second sampling round.

4.3.3 **Surface Water Investigation**

Environmental samples were collected from Brinson Creek and an unnamed tributary to Brinson Creek as part of the surface water investigation at Site 36. A total of seven surface water samples were collected at Site 36. Three of the seven samples were retained from Brinson Creek and the remaining four were obtained from the unnamed tributary to Brinson Creek that borders the southern portion of the study area. Each of the seven surface water samples were analyzed for full TCL organics and TAL inorganics (both total and dissolved fractions), using CLP protocols and Level III data quality.

A discussion of the analytical results from the surface water investigation at Site 36 is provided in subsequent sections. Table 4-2 provides a summary of results of surface water contamination. A positive detection summary of organic compounds found in surface water samples is provided in Table 4-11. Total and dissolved metal results from surface water samples collected at Site 36 are presented in Tables 4-12 and 4-13, respectively. Semivolatile, pesticide, and PCB organic compounds were not detected in any of 7 surface water samples and, therefore, were not considered further. VOCs were not detected in the three surface water samples retained from Brinson Creek and, correspondingly, were not addressed.

4.3.3.1 Brinson Creek

Ten of 23 TAL total metals were positively identified in the three surface water samples obtained from Brinson Creek (36-SW05, 36-SW06, and 36-SW07) as presented in Table 4-12. None of the positive metal detections exceeded either state or federal standards for surface water. Positive detections of metals were compared to contaminant standards for water bodies classified as tidally influenced (i.e., containing at least five percent saltwater).

4.3.3.2 Unnamed Tributary

A positive detection of one volatile organic compound was observed among the four surface water samples retained from the unnamed tributary. The VOC 1,2-dichloroethene was detected at a concentration of 7 µg/L in sample 36-SW02, located adjacent to the southwestern portion of study area near an unimproved vehicle access road.

Laboratory analyses of four surface water samples retained from the unnamed tributary indicate that 14 of 23 total metals were positively detected. As indicated in Table 4-2, copper, iron, and nickel were the only metals identified at concentrations in excess of either NCWQS screening values or National Oceanic and Atmospheric Administration (NOAA) chronic screening values. Nickel was detected at a concentration in excess of the 8.3 µg/L screening value in the surface water sample obtained from 36-SW04. Copper was detected only once among the entire sample set from an upgradient sampling station. The concentration of copper at 36-SW01 was 56.5 µg/L, which exceeded the 3.0 µg/L standard. However, this copper detection did not exceed the maximum base-specific surface water background concentration of 129 µg/L (refer to Appendix P). Iron was detected in each of the samples collected from both Brinson Creek and the unnamed tributary. Positive detections of iron at the three freshwater sampling stations exceeded the 1,000 µg/L screening value and the 1,416 µg/L maximum base-specific background concentration. No other total metal concentrations in the four surface water samples exceeded state of federal screening values.

4.3.4 Sediment Investigation

Environmental samples were collected from Brinson Creek and an unnamed tributary to Brinson Creek as part of the sediment investigation at Site 36. A total of 15 sediment samples were collected at Site 36; 2 vertically separated samples were collected from 6 of the 9 sampling stations and only one sample was collected at stations 36-SD01, 36-SD08, and 36-SD09. At six of the sampling stations a sample was collected from zero to six inches and also from six to twelve inches. Eight of the 15 samples were obtained from Brinson Creek, the remaining 7 samples were obtained from the unnamed tributary that borders the southern portion of the site. Thirteen of the 15 sediment samples was analyzed for full TCL organics and TAL inorganics, using CLP protocols and Level III data quality. The remaining two confirmatory samples were submitted for laboratory analysis of TAL metals only.

Analytical results from the sediment investigation at Site 36 are discussed in the subsections which follow. Table 4-2 provides a summary of sediment contamination. A positive detection summary of organic compounds found in Brinson Creek and the unnamed tributary is provided in Table 4-14. Total metal results from Site 36 sediment samples are presented in Table 4-15. PCB compounds were not detected in any of sediment samples and, therefore, were not addressed.

4.3.4.1 Brinson Creek

VOCs were not detected among the samples analyzed from Brinson Creek. Diethylphthalate and di-n-butylphthalate were each detected once among the six sediment samples, at concentrations of 2,135 and 218 µg/kg. No other SVOCs were detected in sediment samples.

The pesticides 4,4'-DDE, 4,4'-DDD, and 4,4'-DDT were each detected in at least five of the six Brinson Creek sediment samples. Each of the three pesticides were detected at their respective maximum concentrations within a sample retained from station 36-SD05, located adjacent to the mouth of an unnamed tributary that borders the southern portion of the site. As indicated in Table 4-2, each of the detections were in excess of NOAA Effects Range-Low (ER-L) screening values. Detections of the three most frequently detected organic pesticide compounds ranged from 3 µg/kg of 4,4'-DDT to 1,200 µg/kg of 4,4'-DDE. The pesticides dieldrin, endrin aldehyde, and alpha-chlordane were also detected among the six sediment samples from Brinson Creek. Alpha-chlordane was observed in two samples from an upstream sampling location at

concentrations of 6.5 and 13 µg/kg, which exceeded the NOAA screening value of 0.5 µg/kg. Dieldrin was detected twice among samples retained from Brinson Creek at concentrations of 0.8 and 52 µg/kg. Endrin aldehyde was detected once among the six sediment samples at a concentration of 7.6 µg/kg.

Nineteen of 23 TAL total metals were positively identified in the ten Brinson Creek sediment samples (antimony, cadmium, selenium, and silver were not detected; six of eight mercury and zinc analyses were rejected). Lead and mercury were identified at concentrations in excess of their respective NOAA screening values. As provided in Table 4-15, the two detections of mercury from Brinson Creek exceeded the 0.15 mg/kg sediment screening value. Three detections of lead among eight samples from Brinson Creek exceeded the 35 mg/kg standard. Only one of the three lead detections exceeded the base background concentration (refer to Appendix P). Lead was detected at a concentration of 15,100 mg/kg at sample station 36-SD06, located adjacent to the former wharf on Brinson Creek. This concentration of lead represents an exceedance of the NOAA screening value by more than two orders of magnitude. Two supplemental samples (36-SD08 and 36-SD09) were later collected from the former wharf area to confirm the presence of lead; however, lead was not detected in excess of the 35 mg/kg standard.

4.3.4.2 Unnamed Tributary

Tetrachloroethane was the only volatile organic compound detected among the 7 unnamed tributary sediment samples. Tetrachloroethane was identified at a concentration of 4 µg/kg within sample 36-SD04, collected approximately 100 feet upstream of Brinson Creek.

Three SVOCs were identified within sediment samples obtained in the unnamed tributary. As provided in Table 4-14, diethylphthalate, anthracene, and pyrene were detected among the seven samples retained from the unnamed tributary. The maximum semivolatile concentration, 896 µg/kg, was that of diethylphthalate. Diethylphthalate was positively detected within two of the seven samples. Anthracene and pyrene were detected only once among the unnamed tributary samples submitted for laboratory analysis. None of the detections exceeded applicable NOAA screening values.

The pesticides 4,4'-DDD, and 4,4'-DDT were each detected in six of the seven unnamed tributary sediment samples. As indicated in Table 4-14, 4,4'-DDD and 4,4'-DDT were detected at maximum concentrations of 1,030 and 27 µg/kg. The pesticide 4,4'-DDE was detected within three of the seven samples at a maximum concentration of 169 µg/kg. The maximum concentrations of both 4,4'-DDD and 4,4'-DDE were detected in samples obtained at sampling location 36-SD03. The pesticides aldrin, dieldrin, endrin, endosulfan sulfate, endrin ketone, and endrin aldehyde were detected once among the seven sediment samples from the unnamed tributary. The maximum concentrations of these pesticides ranged from 0.8 µg/kg of dieldrin to 11 µg/kg of endrin ketone.

Twenty of 23 TAL total metals were positively identified in the seven sediment samples from the unnamed tributary (antimony, selenium, and silver were not detected; five of the seven mercury and zinc detections were rejected). Cadmium, lead, mercury, nickel, and zinc were each identified at concentrations in excess of NOAA ER-L screening values. As provided in Table 4-2, each of the five metal analytes were detected in excess of sediment screening values in at least one of the unnamed tributary samples. Lead was detected with the greatest frequency among the sample set and at concentrations that exceeded the NOAA screening value of 35 mg/kg in four of the seven samples. Concentrations of lead in samples retained from the unnamed tributary ranged from 17.9 to

148 mg/kg. A single detection of cadmium, mercury, nickel, and zinc exceeded NOAA screening values. All concentrations of TAL metals detected in sediment samples from the unnamed tributary were within base-specific background concentrations, however.

4.4 Extent of Contamination

This section addresses the extent of contamination within soil, groundwater, surface water, and sediment at OU No. 6, Site 36.

4.4.1 Extent of Soil Contamination

Positive detections of organic compounds in surface and subsurface soil samples collected at Site 36 are depicted on Figures 4-1 and 4-2, respectively. The following subsections detail the presence of both organic compounds and inorganic analytes in soil samples from Site 36.

4.4.1.1 Volatiles

Volatile compounds in both surface and subsurface soils at Site 36 appear to be the result of limited site activities within certain portions of the study area. VOCs were detected in 19 of the 123 soil samples collected throughout Site 36. The positive detections were identified in samples from central, northern, western, eastern, and southeastern portions of Site 36. The VOCs 1,2-dichloroethene, trichloroethene, benzene, tetrachloroethene, and total xylenes were each detected at low maximum concentrations (i.e., less than 10 µg/kg). Given the limited extent and concentration of volatile compounds at Site 36, their presence is most likely not the result of previous site operations.

4.4.1.2 Semivolatiles

The presence and dispersion of SVOCs in soil, particularly PAH compounds, are most likely the result of former burning operations at Site 36. Concentrations of PAH compounds in soil samples are consistent with the historical use of the site as a dump and indicative of waste or refuse incineration. Semivolatile compounds were identified in both surface and subsurface soil samples throughout the site; however, considerably higher concentrations of SVOCs were limited to the eastern, southeastern, and central portion of the study area. As depicted on Figures 4-1 and 4-2, concentrations of SVOCs were typically higher in surface samples than in those samples obtained from the subsurface. In general, soil analytical results correspond directly to the visual identification of fill and burn material recorded during the field investigation of the study area (see Appendices A, B, and C for soil descriptions).

4.4.1.3 Pesticides

Positive detections of pesticides were observed in both surface and subsurface soil samples throughout Site 36. As Figures 4-1 and 4-2 depict, the detected pesticide levels were generally low and most likely the result of routine pesticide application. A number of the higher pesticide detections were observed in surface samples obtained from the central and a small area near the western site boundary. Soil samples obtained from the eastern portion had a majority of the higher subsurface pesticide concentrations. As described in Section 2.0, the eastern and central portions of the study area are composed of fill and burned material that may have also included residual

concentrations of pesticides. The frequency and overall concentration of pesticides in soil, however, does not suggest routine or widespread pesticide disposal activities.

4.4.1.4 Polychlorinated Biphenyls

Fourteen of 16 positive detections of PCBs were observed in samples obtained from soil borings located along the western boundary of the site, immediately adjacent to the main site access road. Each of the positive detections of a PCB was observed in conjunction with positive pesticide detections. At one time it was not uncommon to use oil, possibly containing PCBs, as a dust suppressor on roads. The occurrence of both pesticides and PCBs in soil samples suggests that these organic compounds may have been introduced to the site concurrently. The observed levels of PCB contaminants from soil analyses at Site 36 are not characteristic of PCB disposal activities.

4.4.1.5 Metals

As addressed in Section 4.3.1 and depicted in Tables 4-4 and 4-6, fewer than 15 of the 103 samples submitted for analysis had TAL metal concentrations greater than one order of magnitude above base-specific background levels. Inorganic analytes were detected in both surface and subsurface soil samples from the eastern, southeastern, and central portions of the study area at concentrations greater than one order of magnitude above twice the average base-specific background levels. The metals copper, lead, and zinc were observed at maximum concentrations greater than two orders of magnitude above base-specific background levels in a limited number of soil samples from the eastern portion of the study area. Findings from the analytical program are consistent with visual observations of buried metallic objects and fill material recorded during the field investigation (see Appendices A, B, and C). Concentrations of metals in samples obtained from these portions of the study area coincide with areas of fill and buried material. The buried metal, in the presence of naturally-occurring acidic soils, is most probably the source of elevated metal concentrations.

4.4.2 **Extent of Groundwater Contamination**

Positive detections of organic compounds in groundwater samples collected at Site 36 are depicted on Figure 4-3. Figure 4-4 presents TAL metal sampling results in excess of either Federal MCL or NCWQS levels. As addressed in Section 4.3.2, organic semivolatile and PCB compounds were not detected in any of the shallow or deep aquifer samples submitted for analysis from Site 36. As a result of those analyses, the extent of semivolatile and PCB contamination in groundwater will not be addressed.

4.4.2.1 Volatiles

Positive detections of volatile compounds were limited to samples obtained from the shallow aquifer. The lack of positive VOC detections in samples obtained from the deep aquifer suggests that these contaminants have not migrated vertically from the surficial aquifer. The majority of volatile detections were observed in samples from intermediate and shallow wells in the northern portion of the study area; however, two monitoring wells located on the western portion of the site did have low concentrations of 1,2-dichloroethene. The highest concentration of a single VOC, trichloroethene at 97 µg/L, was detected in well 36-GW10IW. Monitoring well 36-GW10IW lies within the northern portion of the study area, as depicted on Figure 4-3. Four other volatile compounds were detected in the shallow and intermediate wells in that vicinity.

The lack of positive VOC detections in other wells, which are hydraulically upgradient of the northern portion of the site, suggests that the extent of VOC contamination in groundwater is limited to the area of the observed locations. Moreover, the limited extent of VOC contamination (i.e., in both soil and groundwater) suggests that the source may have resulted from spillage or limited disposal rather than from long-term disposal or buried containers.

4.4.2.2 Pesticides

The pesticide 4,4'-DDD was detected in only one of the 17 groundwater samples submitted for analysis from Site 36. A sample obtained from monitoring well 36-GW10, located in the northern portion of the study area, exhibited a 0.056 µg/L concentration of 4,4'-DDD. No pesticides were detected in a confirmatory sample retained from the same monitoring well. Subsurface soil analytical results throughout the site indicate the presence of pesticides. Pesticides tend to adhere to soil material; suspended soil particles (colloids) in groundwater samples are likely to have introduced pesticide into the sample. Due to a lack of additional detections, the extent of groundwater pesticide contamination will not be considered further.

4.4.2.3 Metals

Inorganic analytes were detected in each of the 22 groundwater samples submitted for analysis from Site 36. Iron and manganese were the only TAL total metals detected, among samples obtained from the 21 permanent monitoring wells, at levels in excess of either federal MCL or NCWQS (see Figure 4-4). Positive detections of both iron and manganese were distributed throughout the site, indicative of natural site conditions rather than disposal activities. Mercury was detected within a sample obtained from a temporary well at a concentration which exceeded the NCWQS of 1 µg/L by only 0.4 µg/L. Generally, concentrations of TAL metals in shallow groundwater at Site 36 appear to be higher in samples obtained from the western portion of the study area.

Elevated total metal observations have been recorded at other MCB, Camp Lejeune sites and have been attributed as the likely consequence of loose surficial soils. During sampling, a low flow purge method was utilized to minimize the presence suspended solids or colloids in samples that are associated with the surficial soils. The DoN is currently evaluating the presence and distribution of total and dissolved metals in groundwater throughout the facility. The draft report entitled "Evaluation of Metals in Groundwater at MCB, Camp Lejeune, North Carolina," (provided as Appendix P) addresses the pervasiveness of total metals in groundwater and identifies a number of potential causes. Preliminary conclusions of the study support the opinion that total metal concentrations in groundwater are due more to geologic conditions (i.e., naturally occurring concentrations and unconsolidated soils) and sample acquisition methods than to mobile metal concentrations in the surficial aquifer.

4.4.3 Extent of Surface Water Contamination

Positive detections of organic compounds in surface water samples collected at Site 36 are depicted on Figure 4-5. Figure 4-6 presents TAL metal sampling results in excess of state or federal surface water screening values. A summary of site analytical data is presented in Table 4-2. As addressed in Section 4.3.3, semivolatile, pesticide, and PCB organic contaminants were not detected in any of the 7 surface water samples submitted for analysis from Site 36. As a result of those analyses, the extent of semivolatile, pesticide, and PCB organic contamination in surface water will not be addressed. Volatile organic compounds were not detected in the three surface water samples retained from Brinson Creek, correspondingly, the extent of volatile contamination in Brinson Creek will not be addressed.

4.4.3.1 Volatiles

Unnamed Tributary

One volatile contaminant, 1,2-dichloroethene, was detected at a concentration of 7 µg/L. Sediment results from the same sample location exhibited positive detections of semivolatile compounds. As depicted on Figure 4-5, the sampling station is located along the southern boundary of the study area. The occurrence of one positive detection suggests that volatile compounds are not migrating from surface and subsurface soils or sediments at Site 36 via surface water, particularly from areas identified with positive volatile detections in soil.

4.4.3.2 Metals

Brinson Creek

As depicted on Figure 4-6, none of the TAL metals identified in the three Brinson Creek surface water samples were detected at concentrations in excess of screening values. Positive detections of metals were compared to contaminant standards for water bodies classified as tidally influenced (i.e., containing at least five percent saltwater).

Unnamed Tributary

Copper, iron, and nickel were the only TAL metals identified among the four unnamed tributary samples that exceeded state or federal chronic screening values. As depicted on Figure 4-6, three of the unnamed tributary samples had positive detections of iron above the 1,000 µg/L screening value and the maximum base-specific background concentration of 1,416 µg/L. Iron concentrations among the three samples ranged from 2,320 to 4,840 µg/L. Nickel was detected in one downgradient sample at a concentration of 23.2 µg/L which exceeded the 8.3 µg/L screening value. Copper was detected in an upgradient sample at a concentration of 56.5 mg/L which exceeded the 3.0 µg/L screening value. The frequency and concentrations of TAL metals that were detected in excess of screening criteria are not indicative of disposal-related operations. The unnamed tributary that borders the southern portion of the study area serves as one of the many drainage for nearby roadways, parking lots, and operational areas. The location of the unnamed tributary, relative to these operational areas, may account for the metals observed in surface water samples.

4.4.4 Extent of Sediment Contamination

Positive detections of organic compounds in sediment samples collected at Site 36 are depicted on Figure 4-7. Figure 4-8 presents TAL metal sampling results in excess of federal sediment screening values. A summary of site contamination is presented in Table 4-2. As addressed in Section 4.3.4, PCBs were not detected in any of the 13 sediment samples submitted for analysis from Site 36. In addition, volatile compounds were not detected in any of the Brinson Creek samples. As a result of those analyses, the extent of PCB contamination and Brinson Creek volatile contamination of sediments will not be addressed.

4.4.4.1 Volatiles

Unnamed Tributary

Tetrachloroethane was the only VOC detected in the seven unnamed tributary sediment samples collected at Site 36. As Figure 4-7 depicts, the only detection of tetrachloroethane, 4 µg/kg, was observed in a sample collected approximately 100 feet upstream of Brinson Creek. The sample location is also within two-hundred feet of the New River and Edwards Creek. The isolated detection and low concentration of tetrachloroethane suggests that its presence may be the result of migration from the northern portion of Site 36. Tetrachloroethene was detected in both surface soils and groundwater samples retained from the northern portion of the study area.

4.4.4.2 Semivolatiles

Brinson Creek

Two semivolatile organic compounds were identified within the six Brinson Creek sediment samples, as shown on Figure 4-7. Diethylphthalate and di-n-butylphthalate were identified in two samples retained from locations adjacent to the northern portion of the study area. The localized occurrence of SVOCs in sediment at Site 36 may indicate that semivolatile contaminants have migrated to the sediments of Brinson Creek. Soil erosion may provide one possible explanation for the presence of SVOCs in the sediment. At these locations soil from the northern portion of the study area, or from other upstream sources may have been washed into the creek channel.

Unnamed Tributary

Three semivolatile compounds were detected within the seven sediment samples obtained from the unnamed tributary that borders the southern portion of Site 36. As Figure 4-7 suggests, the highest concentrations of SVOCs were detected in sediment samples located adjacent to the study area. The maximum semivolatile concentration was that of diethylphthalate, 896 µg/kg, at a sampling station located adjacent to a known fill area and former drum area. Soil erosion from areas known to have semivolatile contaminants provides one possible explanation for the presence of these compounds in sediments.

4.4.4.3 Pesticides

Brinson Creek

The pesticides dieldrin, 4,4'-DDE, 4,4'-DDD, 4,4'-DDT, endrin aldehyde, and alpha-chlordane were detected within sediment samples from analysis from Brinson Creek. As depicted on Figure 4-7, the maximum concentrations of 4,4'-DDE, 4,4'-DDD, and 4,4'-DDT were obtained from a sample located just downstream of the unnamed tributary's outlet into Brinson Creek. The maximum detections observed at this downstream location may be the result of particles settling out of suspension as they reach this area of lesser hydraulic gradient. In general, higher detections of pesticides were observed in samples retained from Brinson Creek. The detection of organic pesticide contaminants at Site 36 was anticipated, based upon their frequent detection and wide dispersion in environmental media throughout MCB, Camp Lejeune.

Unnamed Tributary

The pesticides aldrin, dieldrin, 4,4'-DDE, endrin, endosulfan sulfate, 4,4'-DDD, 4,4'-DDT, endrin ketone, and endrin aldehyde were detected within sediment samples from the unnamed tributary. As depicted on Figure 4-7, the maximum concentrations of pesticides in these samples were generally less than Brinson Creek samples. The maximum pesticide concentration was that of 4,4'-DDD at 1,030 µg/kg. Concentrations of organic pesticides observed in sediment samples collected at Site 36 are comparable to those seen throughout MCB, Camp Lejeune.

4.4.4.4 Metals

Brinson Creek

A single lead concentration in one of the six Brinson Creek sediment samples exceeded NOAA chronic screening values by more than two orders of magnitude. As depicted in Figure 4-8, only two other sediment samples from Brinson Creek had a concentration of lead that exceeded the screening value. The single detection of lead at 15,100 µg/kg from station 36-SD06 also exceeded base background concentrations (see Appendix P). Two confirmatory sediment samples, collected within the wharf area, did not exhibit lead concentrations above the 35 µg/kg screening value. As mentioned in Section 4.3.4, the area from which this particular sediment sample was collected served as a boat wharf from approximately the 1940s to the 1970s. The construction or maintenance of the wharf area may account for the localized presence of lead at this location.

Unnamed Tributary

Cadmium, lead, mercury, and zinc were each identified at concentrations in excess of NOAA ER-L screening values. As shown on Figure 4-8, each of the four metals were detected in excess of sediment screening values within at least one of the samples from the unnamed tributary. Lead was detected at three locations adjacent to and downstream of the central and southeastern portions of the study area. Cadmium, mercury, and zinc were each detected at concentrations that exceeded NOAA screening values only once among samples retained from the unnamed tributary. No other total metal concentrations, among the seven sediment samples, exceeded screening values. The limited dispersion of TAL metals in sediment samples from the unnamed tributary do not appear to

be the result of disposal operations, however, those results may reflect the presence of surficial and buried metallic debris.

4.5 References

Baker Environmental, Inc. December 1994. Remedial Investigation/Feasibility Study Work Plan for Operable Unit No. 6 (Sites 36, 43, 44, 54, and 86), Marine Corps Base Camp Lejeune, North Carolina. Final. Prepared for the Department of the Navy, Naval Facilities Engineering Command, Atlantic Division, Norfolk, Virginia.

Greenhorne & O'Mara, Inc. 1992. Wellhead Monitoring Study Marine Corps Base, Camp Lejeune, North Carolina. Preliminary Draft. Prepared for Department of the Navy, Naval Facilities Engineering Command, Atlantic Division, Norfolk, Virginia.

United States Environmental Protection Agency (USEPA). 1988. Laboratory Guidelines for Evaluating Inorganics Analysis. Prepared for: Hazardous Site Evaluation Division, U.S. Environmental Protection Agency. Compiled by: Ruth Bleyley. Prepared by: The USEPA Data Review Work Group.

USEPA. 1989. United States Environmental Protection Agency. Risk Assessment Guidance for Superfund Volume II. Environmental Evaluation Manual Interim Final. Office of Solid Waste and Emergency Response. Washington, D.C. EPA/540/1-89-001. May 1989.

USEPA. 1991. National Functional Guidelines for Organic Data Review. Draft. USEPA Contract Laboratory Program.

SECTION 4.0 TABLES

TABLE 4-1

SUMMARY OF REJECTED DATA
 SITE 36, CAMP GEIGER AREA DUMP
 REMEDIAL INVESTIGATION, CTO-0303
 MCB, CAMP LEJEUNE, NORTH CAROLINA

Media	Sample Number	Chemical/Category	Comment
Soils	36-FCA-SB07-01DL	VOCs	1
	36-OA-SB04-00	VOCs	2
	36-FCA-SB07-01	VOCs	3
	36-OA-SB07-01	VOCs	4
	36-FDA-SB01-02		
	36-DAB-SB03-00		
	36-OF-SB04-00	SVOCs	1
	36-FDA-SB01-02	SVOCs	5
	36-DA-SB04-00		
	36-DAD-SB02-01		
	36-DAB-SB03-00		
	36-OA-SB07-00		
	36-OA-SB07-01		
	36-OA-SB001-00	4,4'-DDE Aroclor-1248	6
	36-FDA-SB01-00	4,4'-DDE	6
	36-FDA-SB06-07		
	36-OA-SB04-00		
	36-OF-SB05-00		
	36-OF-SB05-00D		
	36-FCA-SB10-00		
36-DAD-SB02-01	4,4'-DDD	6	
36-DAB-SB03-01	4,4'-DDE 4,4'-DDD	6	
36-OF-SB06-00			
36-OA-SB07-01			
36-OA-SB07-00	4,4'-DDE	6	
36-FDA-SB04-01	4,4'-DDT		
36-OF-SB04-00	4,4'-DDE 4,4'-DDD 4,4'-DDT	6	
36-OA-SB08-00	4,4'-DDE 4,4'-DDD 4,4'-DDT	3	
36-OF-SB03-00	Aldrin Dieldrin	6	

TABLE 4-1 (Continued)

**SUMMARY OF REJECTED DATA
SITE 36, CAMP GEIGER AREA DUMP
REMEDIAL INVESTIGATION, CTO-0303
MCB, CAMP LEJEUNE, NORTH CAROLINA**

Media	Sample Number	Chemical/Category	Comment
Soils (Continued)	36-FDA-SB05-01	Dieldrin 4,4'-DDE 4,4'-DDD 4,4'-DDT alpha-Chlordane gamma-Chlordane	3
	36-OA-SB08-00 36-FDA-SB05-01	All Pesticides/PCBS	7
	36-FCA-SB12-00 36-OF-SB02-00D	All Pesticides/PCBs	8
	36-FCA-SB01-00 36-FCA-SB01-04 36-FCA-SB05-00 36-FCA-SB05-02 36-FCA-SB05-02MS 36-FCA-SB05-02MD 36-FCA-SB08-00 36-FCA-SB08-01 36-OA-SB05-00 36-OA-SB05-02 36-OA-SB06-00 36-OA-SB06-02	Antimony	9

Comments:

1. Reject all results except for the D-flagged results that correspond with E-flagged results in the original sample.
2. Reject all results for the re-analyzed samples in favor of the original samples due to noncompliant internal standard areas.
3. Reject results in favor of the diluted analysis for the sample.
4. Reject all results for the original samples in favor of the re-analyzed samples due to noncompliant internal standard areas.
5. Reject all results due to noncompliant internal standard areas.
6. For the specified compounds, reject results in favor of the diluted analysis for the sample. Results for all other compounds are from the undiluted analysis.
7. Reject results of all compounds except those noted in favor of the undiluted analysis of the sample.
8. Reject results in favor of the results reported in the undiluted analysis of the sample.
9. Matrix spike recovery was below 30%. All nondetected results are rejected.

TABLE 4-2

**SUMMARY OF SITE CONTAMINATION
SITE 36, CAMP GEIGER AREA DUMP
REMEDIAL INVESTIGATION, CTO-0303
MCB, CAMP LEJEUNE, NORTH CAROLINA**

Media	Fraction	Detected Contaminants	Comparison Criteria		Site Contamination				
			Standard	Base Background	Min.	Max.	Max. Location	Detection Frequency	Distribution
Surface Soil (1)	Volatiles	Trichloroethene	NA	NA	4	4	FDA-SB03	1/61	eastern, former disposal area
		Tetrachloroethene	NA	NA	2	3	36-GW12	3/61	northern, ground scar area
		Toluene	NA	NA	8	98	OF-SB01	4/61	south central, open field
		Styrene	NA	NA	39	39	GS-SB03	1/61	northern, ground scar area
		Xylene (total)	NA	NA	7	7	OF-SB06B	1/61	south central, open field
	Semivolatiles	n-Nitro-di-n-propylamine	NA	NA	320	320	DAB-SB03	1/57	southeastern, drum area
		Naphthalene (PAH)	NA	NA	48	120	OF-SB04	2/57	1 south central, 1 western
		2-Methylnaphthalene	NA	NA	54	82	OA-SB01A	2/57	1 south central, 1 western
		Acenaphthene (PAH)	NA	NA	330	330	OF-SB04	1/57	south central, open field
		Dibenzofuran	NA	NA	150	150	OF-SB04	1/57	south central, open field
		Fluorene (PAH)	NA	NA	200	200	OF-SB04	1/57	south central, open field
		Phenanthrene (PAH)	NA	NA	59	2,500	OF-SB04	4/57	scattered
		Anthracene (PAH)	NA	NA	780	780	OF-SB04	1/57	south central, open field
		Carbazole	NA	NA	240	240	OF-SB04	1/57	south central, open field
		Fluoranthene (PAH)	NA	NA	54	5,500	OF-SB04	5/57	4 southeastern, drum area
		Pyrene (PAH)	NA	NA	41	11,000	OF-SB04	8/57	5 southeastern, drum area
		Butylbenzylphthalate	NA	NA	51	290	OA-SB03	3/57	western
		B(a)anthracene (PAH)	NA	NA	46	3,900	OF-SB04	2/57	1 south central, 1 southeastern
		Chrysene (PAH)	NA	NA	51	4,600	OF-SB04	5/57	3 southeastern, drum area
		B(b)fluoranthene (PAH)	NA	NA	51	3,600	OF-SB04	3/57	scattered
		B(k)fluoranthene (PAH)	NA	NA	39	1,500	OF-SB04	2/57	1 south central, 1 southeastern
		Benzo(a)pyrene (PAH)	NA	NA	40	3,300	OF-SB04	2/57	1 south central, 1 western
		I(1,2,3-cd)pyrene (PAH)	NA	NA	46	2,700	OF-SB04	3/57	scattered
D(a,h)anthracene (PAH)	NA	NA	720	720	OF-SB04	1/57	south central, open field		
B(g,h,i)perylene (PAH)	NA	NA	2,400	2,400	OF-SB04	1/57	south central, open field		

TABLE 4-2 (Continued)

**SUMMARY OF SITE CONTAMINATION
SITE 36, CAMP GEIGER AREA DUMP
REMEDIAL INVESTIGATION, CTO-0303
MCB, CAMP LEJEUNE, NORTH CAROLINA**

Media	Fraction	Detected Contaminants	Comparison Criteria		Site Contamination				
			Standard	Base Background	Min.	Max.	Max. Location	Detection Frequency	Distribution
Surface Soil (Continued)	Pesticides	gamma-BHC (Lindane)	NA	NA	4.0	4.0	OF-SB06D	1/57	south central, open field
		Heptachlor	NA	NA	1.9	1.9	FCA-SB12	1/57	southwestern, former cleared area
		Aldrin	NA	NA	5.5	1,400	OF-SB03	3/57	1 open field, 2 adjacent to SB01
		Heptachlor epoxide	NA	NA	2	67	OA-SB01I	10/57	scattered, 3 adjacent to SB01
		Endosulfan I	NA	NA	8.3	36	OA-SB01E	3/57	all adjacent to SB01
		Dieldrin	NA	NA	2	16,000	OF-SB03	21/57	scattered
		4-4'-DDE	NA	NA	2.2	2,600	OA-SB01A	49/57	widely scattered, prevalent
		Endrin	NA	NA	9.9	9.9	OA-SB08	1/57	eastern, former disposal area
		4-4'-DDD	NA	NA	2.8	550	OA-SB01A	37/57	widely scattered, prevalent
		Endosulfan Sulfate	NA	NA	2.5	4.2	OF-SB06	2/57	1 south central, 1 western
		4-4'-DDT	NA	NA	1.8	12,000	OA-SB01A	48/57	widely scattered, prevalent
		Endrin Ketone	NA	NA	15	15	OF-SB03	1/57	south central, open field
		Endrin aldehyde	NA	NA	12	12	OF-SB02	1/57	south central, open field
		alpha-Chlordane	NA	NA	1.2	980	OA-SB05	15/57	scattered
		gamma-Chlordane	NA	NA	1.2	840	OA-SB05	10/57	scattered
	PCBs	Aroclor 1248	NA	NA	68	24,000	OA-SB01I	9/57	western, surrounding SB01
		Aroclor 1254	NA	NA	92	530	OA-SB01	3/57	western, surrounding SB01
	Metals (2)	Antimony	NA	5.3	3.3	31.7	OA-SB08	7/46	5 exceed BB, scattered
		Arsenic	NA	1.3	0.4	10.4	OA-SB08	43/52	22 exceed BB, scattered
		Cadmium	NA	0.7	0.7	6.3	OA-SB08	8/52	7 exceed BB, scattered
		Chromium	NA	6.7	1.6	51.6	OA-SB08	52/52	27 exceed BB, scattered
		Copper	NA	7.2	0.6	445	OA-SB08	39/52	25 exceed BB, scattered
		Lead	NA	23.7	4.3	836	OA-SB08	48/52	24 exceed BB, scattered
		Mercury	NA	0.1	0.1	2.4	OA-SB05	18/52	18 exceed BB, scattered
		Nickel	NA	3.4	1	48.3	OA-SB08	26/52	13 exceed BB, scattered
		Silver	NA	0.9	0.6	12	OF-SB04	8/48	5 exceed BB, 3 south central
		Zinc	NA	13.9	2.1	1,320	OA-SB08	50/52	34 exceed BB, scattered

TABLE 4-2 (Continued)

SUMMARY OF SITE CONTAMINATION
 SITE 36, CAMP GEIGER AREA DUMP
 REMEDIAL INVESTIGATION, CTO-0303
 MCB, CAMP LEJEUNE, NORTH CAROLINA

Media	Fraction	Detected Contaminants	Comparison Criteria		Site Contamination				
			Standard	Base Background	Min.	Max.	Max. Location	Detection Frequency	Distribution
Subsurface Soil	Volatiles	Acetone	NA	NA	12	480	GS-SB03	8/62	1 exceeds blank, ground scar area
		1,2-Dichloroethene (total)	NA	NA	4	4	OA-SB01	1/62	western
		Trichloroethene	NA	NA	3	5	FDA-SB01	3/62	2 eastern, 1 western
		Benzene	NA	NA	3	3	FDA-SB01	1/62	eastern, former disposal area
		Toluene	NA	NA	5	17	OF-SB06	5/62	south central, open field
		Xylene (total)	NA	NA	2	6	FDA-SB06	8/62	scattered
	Semivolatiles	1,4-Dichlorobenzene	NA	NA	97	97	DAB-SB02	1/57	southeastern, drum area
		2-Methylphenol	NA	NA	510	510	DAB-SB01	1/58	southeastern, drum area
		4-Methylphenol	NA	NA	43	43	DAB-SB01	1/58	southeastern, drum area
		Isophorone	NA	NA	2,100	2,100	DAB-SB01	1/58	southeastern, drum area
		Naphthalene (PAH)	NA	NA	41	41	OA-SB01A	1/57	western
		2-Methylnaphthalene	NA	NA	65	85	FDA-SB02	2/57	1 eastern, 1 western
		Phenanthrene (PAH)	NA	NA	48	190	OA-SB07	3/57	scattered
		Di-n-butylphthalate	NA	NA	56	56	OA-SB01	1/58	western
		Fluoranthene (PAH)	NA	NA	130	320	OA-SB07	3/57	2 eastern, 1 south central
		Pyrene (PAH)	NA	NA	59	320	OA-SB07	5/57	scattered
		Butylbenzylphthalate	NA	NA	42	170	OA-SB03	3/57	scattered
		B(a)anthracene (PAH)	NA	NA	69	140	OA-SB07	3/57	scattered
		Chrysene (PAH)	NA	NA	41	200	OA-SB07	5/57	3 eastern, former disposal area
		B(b)fluoranthene (PAH)	NA	NA	44	170	OA-SB07	5/57	4 eastern, 1 south central
		B(k)fluoranthene (PAH)	NA	NA	42	68	OA-SB07	3/57	eastern, former disposal area
		Benzo(a)pyrene (PAH)	NA	NA	72	450	GS-SB03	4/57	3 eastern, 1 northern
		I(1,2,3-cd)pyrene (PAH)	NA	NA	48	110	OA-SB07	3/57	eastern, former disposal area
B(g,h,i)perylene (PAH)	NA	NA	42	89	OA-SB07	2/57	eastern, former disposal area		

TABLE 4-2 (Continued)

**SUMMARY OF SITE CONTAMINATION
SITE 36, CAMP GEIGER AREA DUMP
REMEDIAL INVESTIGATION, CTO-0303
MCB, CAMP LEJEUNE, NORTH CAROLINA**

Media	Fraction	Detected Contaminants	Comparison Criteria		Site Contamination				
			Standard	Base Background	Min.	Max.	Max. Location	Detection Frequency	Distribution
Subsurface Soil (Continued)	Pesticides	gamma-BHC (Lindane)	NA	NA	4	4	OF-SB06D	1/56	open field
		Aldrin	NA	NA	1.5	16	36-GW11	5/56	3 southeastern, 2 eastern
		Heptachlor Epoxide	NA	NA	3.4	14	36-GW11	3/56	3 eastern, former disposal area
		Dieldrin	NA	NA	2.2	1,200	FDA-SB05	17/56	scattered
		4,4'-DDE	NA	NA	2.3	1,700	OA-SB01A	29/56	widely scattered, prevalent
		Endrin	NA	NA	2.4	5	OF-SB06B	5/56	scattered
		Endosulfan II	NA	NA	2.0	2.0	OF-SB06B	1/56	south central, open field
		4,4'-DDD	NA	NA	2.3	1,300	FDA-SB05	30/56	widely scattered, prevalent
		4,4'-DDT	NA	NA	2.8	3,100	OA-SB01A	28/56	widely scattered, prevalent
		Endrin Aldehyde	NA	NA	3.5	32	FDA-SB05	3/56	2 south central, 1 eastern
		alpha-Chlordane	NA	NA	1.6	750	36-GW11	12/56	primarily eastern
	gamma-Chlordane	NA	NA	2.3	770	36-GW11	9/56	primarily eastern	
	PCBs	Aroclor 1248	NA	NA	19	850	OA-SB01	5/56	western, adjacent to SB01
	Metals (2)	Antimony	NA	6.4	4.9	21.6	36-GW11	7/44	3 exceed BB, eastern
		Arsenic	NA	1.9	0.2	25.9	FDA-SB01	41/51	18 exceed BB, eastern and central
		Cadmium	NA	0.7	0.7	42.8	36-GW11	11/51	9 exceed BB, eastern and central
		Chromium	NA	12.6	1.4	71.9	36-GW11	50/51	14 exceed BB, eastern and central
		Copper	NA	2.4	0.5	1,320	OF-SB06B	31/51	25 exceed BB, scattered
		Lead	NA	8.3	1.2	2,680	OA-SB07	50/51	32 exceed BB, scattered
		Mercury	NA	0.1	0.1	3.9	OA-SB07	13/51	12 exceed BB, east/southeastern
Nickel		NA	3.7	1.1	72.1	DAD-SB02	24/51	19 exceed BB, scattered	
Selenium		NA	0.8	0.4	1.2	OF-SB06	4/51	1 exceeds BB, southcentral	
Zinc	NA	6.7	0.9	2,580	FDA-SB05	41/51	28 exceed BB, scattered		
Groundwater	Volatiles (3)	Methylene Chloride	NCWQS - 5	NA	1	1	36-GW10	1/29	does not exceed standard
		1,2-Dichloroethene (total)	MCL - 70	NA	4	37	36-GW10IW	8/29	none exceed standard
		Trichloroethene	NCWQS - 2.8	NA	3	97	36-GW10IW	10/29	10 exceed standard, 8 northern
		Tetrachloroethene	NCWQS - 0.7	NA	1	2	36-GW10IW	2/29	both exceed standard, northern
		1,1,2,2-Tetrachloroethane	NA	NA	3	10	36-GW10IW	6/29	northern, former ground scar area

TABLE 4-2 (Continued)

SUMMARY OF SITE CONTAMINATION
 SITE 36, CAMP GEIGER AREA DUMP
 REMEDIAL INVESTIGATION, CTO-0303
 MCB, CAMP LEJEUNE, NORTH CAROLINA

Media	Fraction	Detected Contaminants	Comparison Criteria		Site Contamination				
			Standard	Base Background	Min.	Max.	Max. Location	Detection Frequency	Distribution
Groundwater (Continued)	Semivolatiles	ND	NCWQS/MCL	NA				0/17	
	Pesticides	4,4'-DDD	NA	NA	0.06	0.06	36-GW10	1/18	northern, during Round One only
	PCBs	ND	NCWQS/MCL	NA				0/18	
	Total Metals	Iron	NCWQS - 300	NA	3.3	16,900	36-GW02	20/22	12 exceed standard, scattered
		Manganese	NCWQS - 50	NA	19.2	3,180	36-GW09	20/22	12 exceed standard, scattered
	Mercury	NCWQS - 1.1	NA	1.4	1.4	36-TW02	1/22	1 exceeds standard, southern	
Surface Water (4)	Volatiles	1,2-Dichloroethene (total)	NCWQS - 7.0	NA	7	7	36-SW02	1/7	UT, upgradient of open field
	Semivolatiles	ND	NCWQS/NOAA	NA				0/7	
	Pesticides	ND	NCWQS/NOAA	NA				0/7	
	PCBs	ND	NCWQS/NOAA	NA				0/7	
	Metals (5)	Copper	NCWQS - 3.0	129	56.5	56.5	36-SW01	1/7	1 exceeds standard, not BB
		Iron	NOAA - 1,000	1416	967	4840	36-SW03	7/7	3 exceed standard and BB
Nickel		NCWQS - 8.3	ND	16.4	31.4	36-SW02	4/7	4 exceed standard	
Sediment	Volatiles	Tetrachloroethane	NA	NA	4	4	36-SD04	1/13	near mouth of UT at BC
	Semivolatiles	Diethylphthalate	NA	NA	330	2,135	36-SD05	3/13	UT and near mouth of UT
		Anthracene	NOAA - 85	NA	46	46	36-SD04	1/13	does not exceed standard, UT
		Di-n-butylphthalate	NA	NA	218	218	36-SD06	1/13	BC, adjacent to ground scar area
		Pyrene (PAH)	NOAA - 350	NA	316	316	36-SD02	1/13	UT, does not exceed standard
	Pesticides	Aldrin	NA	NA	0.9	0.9	36-SD01	1/13	UT, upgradient
		Dieldrin	NA	NA	0.8	52	36-SD06	3/13	2 from BC, minimum from UT
		4,4'-DDE	NOAA - 2	NA	32	1,200	36-SD05	9/13	9 exceed standard, higher in BC
		Endrin	NOAA - 0.02	NA	6.6	6.6	36-SD02	1/13	UT, upgradient of open field
		4,4'-DDD	NOAA - 2	NA	14	1,140	36-SD05	12/13	12 exceed standard
		Endosulfan Sulfate	NA	NA	3	3	36-SD02	1/13	UT, upgradient of open field
		4,4'-DDT	NOAA - 1	NA	3	46	36-SD05	11/13	11 exceed standard
		Endrin Ketone	NA	NA	11	11	36-SD03	1/13	UT, adjacent to open field
		Endrin Aldehyde	NA	NA	3.5	7.6	36-SD05	2/13	1 from BC, 1 from UT
alpha-Chlordane		NOAA - 0.5	NA	6.5	13	36-SD07	2/13	2 exceed standard, upgradient BC	

TABLE 4-2 (Continued)

SUMMARY OF SITE CONTAMINATION
 SITE 36, CAMP GEIGER AREA DUMP
 REMEDIAL INVESTIGATION, CTO-0303
 MCB, CAMP LEJEUNE, NORTH CAROLINA

Media	Fraction	Detected Contaminants	Comparison Criteria		Site Contamination				
			Standard	Base Background	Min.	Max.	Max. Location	Detection Frequency	Distribution
Sediment (Continued)	PCBs	ND	NOAA	NA				0/13	
	Metals (5)	Cadmium	NOAA - 5	1.3	1.4	8.7	36-SD02	2/15	1 exceeds standard and BB, UT
		Lead	NOAA - 35	314	7.1	15,100	36-SD06	12/15	7 exceed standard, 1 exceeds BB
		Mercury	NOAA - 0.15	ND	0.2	0.7	36-SD04	3/4	3 exceed standard, 11 rejected
		Nickel	NOAA - 30	6.0	2.1	77.1	36-SD03	11/15	1 exceeds standard, from UT
Zinc	NOAA - 120	926	25.3	140	36-SD02	5/5	1 exceeds standard, not BB, UT		

Notes:

- Concentrations are presented in µg/L for liquid and µg/Kg for solids (ppb), metal concentrations for soils and sediments are presented in mg/Kg (ppm).
 - (1) Detection frequencies for surface soil do not include confirmatory, unvalidated, analytical results from samples collected in May 1996.
 - (2) Metals in both surface and subsurface soils were compared to twice the average base background positive concentrations for priority pollutant metals only (i.e., antimony, arsenic, beryllium, cadmium, chromium, copper, lead, mercury, nickel, selenium, silver, thallium, zinc).
 - (3) An additional round of groundwater samples were collected from wells which exhibited concentrations of volatiles during the first round.
 - (4) Surface water detections were compared to appropriate NCWQS and NOAA screening values, based upon the observed percentage of saltwater at each sampling location.
 - (5) Total metals in surface water and sediment were compared to the maximum positive detections in upgradient samples at MCB, Camp Lejeune.
- BB - Base background, value equals two times average value for soil and the maximum value for surface water and sediment (refer to Appendix P)
- BC - Brinson Creek
- BEHP - bis(2-ethylhexyl)phthalate
- NA - Not applicable
- NCWQS - North Carolina Water Quality Standard
- ND - Not detected
- NOAA - National Oceanic and Atmospheric Administration
- MCL - Federal Maximum Contaminant Level
- PAH - Polynuclear aromatic hydrocarbon
- UT - Unnamed Tributary

TABLE 4-3
SURFACE SOIL - POSITIVE DETECTION SUMMARY
SITE 36, CAMP GEIGER AREA DUMP
REMEDIAL INVESTIGATION, CTO-0303
MCB, CAMP LEJEUNE, NORTH CAROLINA
TCL ORGANICS

LOCATION	36-DAB-SB01-00	36-DAB-SB02-00	36-DAB-SB03-00	36-DAD-SB01-00	36-DAD-SB02-00	36-DAD-SB03-00
DATE SAMPLED	02/24/95	02/24/95	02/24/95	02/24/95	02/24/95	02/24/95
DEPTH	0-12"	0-12"	0-12"	0-12"	0-12"	0-12"
VOLATILES (ug/kg)						
ACETONE	12 U	12 U	130 U	19 U	14 U	15 U
TRICHLOROETHENE	12 U	12 U	130 U	17 U	14 U	15 U
TETRACHLOROETHENE	12 U	12 U	130 U	17 UJ	14 U	15 U
TOLUENE	12 U	12 U	130 U	17 UJ	14 U	15 U
STYRENE	12 U	12 U	130 U	17 UJ	14 U	15 U
XYLENE (TOTAL)	12 U	12 U	130 U	17 UJ	14 U	15 U
SEMIVOLATILES (ug/kg)						
N-NITROSO-DI-N-PROPYLAMINE	390 U	400 U	320 J	560 U	450 U	500 U
NAPHTHALENE	390 U	400 U	440 U	560 U	450 U	500 U
2-METHYLNAPHTHALENE	390 U	400 U	440 U	560 U	450 U	500 U
ACENAPHTHENE	390 U	400 U	440 U	560 U	450 U	500 U
DIBENZOFURAN	390 U	400 U	440 U	560 U	450 U	500 U
DIETHYLPHTHALATE	390 U	400 U	440 U	560 U	450 U	500 U
FLUORENE	390 U	400 U	440 U	560 U	450 U	500 U
PHENANTHRENE	390 U	400 U	68 J	560 U	59 J	500 U
ANTHRACENE	390 U	400 U	440 U	560 U	450 U	500 U
CARBAZOLE	390 U	400 U	440 U	560 U	450 U	500 U
FLUORANTHENE	390 U	400 U	88 J	100 J	140 J	54 J
PYRENE	41 J	400 U	120 J	110 J	130 J	140 J
BUTYLBENZYLPHTHALATE	390 U	400 U	440 UJ	560 U	450 U	500 UJ
BENZO(A)ANTHRACENE	390 U	400 U	46 J	560 U	450 U	500 UJ
CHRYSENE	390 U	400 U	51 J	60 J	73 J	500 UJ
BIS(2-ETHYLHEXYL)PHTHALATE	390 U	400 U	440 UJ	560 U	450 U	180 J
BENZO(B)FLUORANTHENE	390 U	400 U	440 U	560 UJ	81 J	500 U
BENZO(K)FLUORANTHENE	39 J	400 U	440 U	560 UJ	450 U	500 U
BENZO(A)PYRENE	390 U	400 U	440 U	560 UJ	450 U	500 U
INDENO(1,2,3-CD)PYRENE	390 U	400 U	58 J	560 UJ	450 U	500 U
DIBENZO(A,H)ANTHRACENE	390 U	400 U	440 U	560 UJ	450 U	500 U
BENZO(G,H,I)PERYLENE	390 U	400 U	440 U	560 UJ	450 U	500 U

UG/KG - microgram per kilogram

J - value is estimated

U - not detected

UJ - not detected, value is estimated

* Data Not Validated

TABLE 4-3
SURFACE SOIL - POSITIVE DETECTION SUMMARY
SITE 36, CAMP GEIGER AREA DUMP
REMEDIAL INVESTIGATION, CTO-0303
MCB, CAMP LEJEUNE, NORTH CAROLINA
TCL ORGANICS

LOCATION	36-DAB-SB01-00	36-DAB-SB02-00	36-DAB-SB03-00	36-DAD-SB01-00	36-DAD-SB02-00	36-DAD-SB03-00
DATE SAMPLED	02/24/95	02/24/95	02/24/95	02/24/95	02/24/95	02/24/95
DEPTH	0-12"	0-12"	0-12"	0-12"	0-12"	0-12"
PESTICIDES/PCBs (ug/kg)						
GAMMA-BHC (LINDANE)	19 U	2 UJ	2.2 U	2.8 UJ	2.2 UJ	2.5 UJ
HEPTACHLOR	19 U	2 UJ	2.2 U	2.8 UJ	2.2 UJ	2.5 UJ
ALDRIN	19 U	2 UJ	2.2 U	2.8 UJ	2.2 UJ	2.5 UJ
HEPTACHLOR EPOXIDE	19 U	2 UJ	2.2 U	2.8 UJ	2.2 UJ	3 J
ENDOSULFAN I	19 U	2 UJ	2.2 U	2.8 UJ	2.2 UJ	2.5 UJ
DIELDRIN	39 U	8.9 J	4.4 U	5.6 UJ	4.4 UJ	5 UJ
4,4'-DDE	960	67 J	55 J	530 J	31 J	61 J
ENDRIN	39 U	4.1 UJ	4.4 U	5.6 UJ	4.4 UJ	5 UJ
4,4'-DDD	120 J	16 J	6.1 J	39 J	4.9 J	7.4 J
ENDOSULFAN SULFATE	39 U	4.1 UJ	4.4 U	5.6 UJ	4.4 UJ	5 UJ
4,4'-DDT	3300 J	7.7 J	17	60 J	10 J	17 J
ENDRIN KETONE	39 U	4.1 UJ	4.4 U	5.6 UJ	4.4 UJ	5 UJ
ENDRIN ALDEHYDE	39 U	4.1 UJ	4.4 U	5.6 UJ	4.4 UJ	5 UJ
ALPHA-CHLORDANE	19 U	2 UJ	2.2 U	2.8 UJ	2.2 UJ	2.5 UJ
GAMMA-CHLORDANE	19 U	2 UJ	2.2 U	2.8 UJ	2.2 UJ	2.5 UJ
AROCLOR-1248	390 U	41 UJ	44 U	56 UJ	44 UJ	50 UJ
AROCLOR-1254	390 U	41 UJ	44 U	56 UJ	44 UJ	50 UJ

UG/KG - microgram per kilogram
 J - value is estimated
 U - not detected
 UJ - not detected, value is estimated
 * Data Not Validated

TABLE 4-3
SURFACE SOIL - POSITIVE DETECTION SUMMARY
SITE 36, CAMP GEIGER AREA DUMP
REMEDIAL INVESTIGATION, CTO-0303
MCB, CAMP LEJEUNE, NORTH CAROLINA
TCL ORGANICS

LOCATION	36-FCA-SB01-00	36-FCA-SB02-00	36-FCA-SB03-00	36-FCA-SB04-00	36-FCA-SB05-00	36-FCA-SB06-00
DATE SAMPLED	02/27/95	02/22/95	02/23/95	02/25/95	02/27/95	02/23/95
DEPTH	0-12"	0-12"	0-12"	0-12"	0-12"	0-12"
VOLATILES (ug/kg)						
ACETONE	14 U	16 U	12 U	12 U	14 U	14 U
TRICHLOROETHENE	14 U	16 U	12 U	12 U	14 U	14 U
TETRACHLOROETHENE	14 U	16 U	12 U	12 U	14 U	14 U
TOLUENE	14 U	16 U	12 U	12 U	14 U	14 U
STYRENE	14 U	16 U	12 U	12 U	14 U	14 U
XYLENE (TOTAL)	14 U	16 U	12 U	12 U	14 U	14 U
SEMIVOLATILES (ug/kg)						
N-NITROSO-DI-N-PROPYLAMINE	470 U	520 U	410 U	400 U	460 U	460 U
NAPHTHALENE	470 U	520 U	410 U	400 U	460 U	460 U
2-METHYLNAPHTHALENE	470 U	520 U	410 U	400 U	460 U	460 U
ACENAPHTHENE	470 U	520 U	410 U	400 U	460 U	460 U
DIBENZOFURAN	470 U	520 U	410 U	400 U	460 U	460 U
DIETHYLPHTHALATE	470 U	520 U	410 U	400 U	460 U	460 U
FLUORENE	470 U	520 U	410 U	400 U	460 U	460 U
PHENANTHRENE	470 U	520 U	410 U	400 U	460 U	460 U
ANTHRACENE	470 U	520 U	410 U	400 U	460 U	460 U
CARBAZOLE	470 U	520 U	410 U	400 U	460 U	460 U
FLUORANTHENE	470 U	520 U	410 U	400 U	460 U	460 U
PYRENE	470 UJ	520 UJ	410 U	400 U	460 UJ	460 U
BUTYLBENZYLPHTHALATE	470 UJ	520 UJ	410 U	400 U	460 UJ	460 U
BENZO(A)ANTHRACENE	470 UJ	520 UJ	410 U	400 U	460 UJ	460 U
CHRYSENE	470 UJ	520 UJ	410 U	400 U	460 UJ	460 U
BIS(2-ETHYLHEXYL)PHTHALATE	200 J	520 UJ	90 J	400 U	460 UJ	460 U
BENZO(B)FLUORANTHENE	470 U	520 U	410 U	400 U	460 U	460 U
BENZO(K)FLUORANTHENE	470 U	520 U	410 U	400 U	460 U	460 U
BENZO(A)PYRENE	470 U	520 U	410 U	400 U	460 U	460 U
INDENO(1,2,3-CD)PYRENE	470 U	520 U	410 U	400 U	460 U	460 U
DIBENZO(A,H)ANTHRACENE	470 U	520 U	410 U	400 U	460 U	460 U
BENZO(G,H,I)PERYLENE	470 U	520 U	410 U	400 U	460 U	460 U

UG/KG - microgram per kilogram

J - value is estimated

U - not detected

UJ - not detected, value is estimated

* Data Not Validated

TABLE 4-3
SURFACE SOIL - POSITIVE DETECTION SUMMARY
SITE 36, CAMP GEIGER AREA DUMP
REMEDIAL INVESTIGATION, CTO-0303
MCB, CAMP LEJEUNE, NORTH CAROLINA
TCL ORGANICS

LOCATION	36-FCA-SB01-00	36-FCA-SB02-00	36-FCA-SB03-00	36-FCA-SB04-00	36-FCA-SB05-00	36-FCA-SB06-00
DATE SAMPLED	02/27/95	02/22/95	02/23/95	02/25/95	02/27/95	02/23/95
DEPTH	0-12"	0-12"	0-12"	0-12"	0-12"	0-12"
PESTICIDES/PCBs (ug/kg)						
GAMMA-BHC (LINDANE)	2.3 UJ	2.6 UJ	2 UJ	2 UJ	2.3 U	2.3 U
HEPTACHLOR	2.3 UJ	2.6 UJ	2 U	2 UJ	2.3 U	2.3 U
ALDRIN	2.3 UJ	2.6 UJ	2 U	2 UJ	2.3 U	2.3 U
HEPTACHLOR EPOXIDE	2.3 UJ	2.6 UJ	2 U	2 UJ	2.3 U	2.3 U
ENDOSULFAN I	2.3 UJ	2.6 UJ	2 U	2 UJ	2.3 U	2.3 U
DIELDRIN	4.2 J	11 J	12	4 UJ	4.7 U	4.6 U
4,4'-DDE	27 J	12 J	12 J	33 J	3.3 J	4.6 U
ENDRIN	4.6 UJ	5.2 UJ	4.1 U	4 UJ	4.7 U	4.6 U
4,4'-DDD	2.8 J	5.2 UJ	4.9 J	4.8 J	4.7 U	4.6 U
ENDOSULFAN SULFATE	4.6 UJ	5.2 UJ	4.1 U	4 UJ	4.7 U	4.6 U
4,4'-DDT	15 J	4.2 J	13 J	23 J	4.7 U	4.6 U
ENDRIN KETONE	4.6 UJ	5.2 UJ	4.1 U	4 UJ	4.7 U	4.6 U
ENDRIN ALDEHYDE	4.6 UJ	5.2 UJ	4.1 U	4 UJ	4.7 U	4.6 U
ALPHA-CHLORDANE	17 J	2.6 UJ	2 U	2 UJ	2.3 U	2.3 U
GAMMA-CHLORDANE	13 J	2.6 UJ	2 U	2 UJ	2.3 U	2.3 U
AROCLOR-1248	46 UJ	52 UJ	41 U	40 UJ	47 U	46 U
AROCLOR-1254	46 UJ	52 UJ	41 U	40 UJ	47 U	46 U

UG/KG - microgram per kilogram

J - value is estimated

U - not detected

UJ - not detected, value is estimated

* Data Not Validated

TABLE 4-3
SURFACE SOIL - POSITIVE DETECTION SUMMARY
SITE 36, CAMP GEIGER AREA DUMP
REMEDIAL INVESTIGATION, CTO-0303
MCB, CAMP LEJEUNE, NORTH CAROLINA
TCL ORGANICS

LOCATION	36-FCA-SB07-00	36-FCA-SB08-00	36-FCA-SB09-00	36-FCA-SB10-00	36-FCA-SB11-00	36-FCA-SB12-00
DATE SAMPLED	02/22/95	02/27/95	02/22/95	02/22/95	02/23/95	02/22/95
DEPTH	0-12"	0-12"	0-12"	0-12"	0-12"	0-12"
VOLATILES (ug/kg)						
ACETONE	13 U	14 U	14 U	12 U	13 U	12 U
TRICHLOROETHENE	13 U	14 U	14 U	12 U	13 U	12 U
TETRACHLOROETHENE	13 U	14 U	14 U	12 U	13 U	12 U
TOLUENE	13 U	14 U	14 U	12 U	13 U	12 U
STYRENE	13 U	14 U	14 U	12 U	13 U	12 U
XYLENE (TOTAL)	13 U	14 U	14 U	12 U	13 U	12 U
SEMIVOLATILES (ug/kg)						
N-NITROSO-DI-N-PROPYLAMINE	420 U	400 U	440 U	400 U	420 U	390 U
NAPHTHALENE	420 U	400 U	440 U	400 U	420 U	390 U
2-METHYLNAPHTHALENE	420 U	400 U	440 U	400 U	420 U	390 U
ACENAPHTHENE	420 U	400 U	440 U	400 U	420 U	390 U
DIBENZOFURAN	420 U	400 U	440 U	400 U	420 U	390 U
DIETHYLPHTHALATE	420 U	400 U	440 U	400 U	420 U	390 U
FLUORENE	420 U	400 U	440 U	400 U	420 U	390 U
PHENANTHRENE	420 U	400 U	440 U	400 U	420 U	390 U
ANTHRACENE	420 U	400 U	440 U	400 U	420 U	390 U
CARBAZOLE	420 U	400 U	440 U	400 U	420 U	390 U
FLUORANTHENE	420 U	400 U	440 U	400 U	420 U	390 U
PYRENE	420 U	400 UJ	440 U	400 U	420 U	390 U
BUTYLBENZYLPHTHALATE	420 U	400 UJ	440 U	400 U	420 U	390 U
BENZO(A)ANTHRACENE	420 U	400 UJ	440 U	400 U	420 U	390 U
CHRYSENE	420 U	400 UJ	440 U	400 U	420 U	390 U
BIS(2-ETHYLHEXYL)PHTHALATE	140 J	400 UJ	140 J	400 U	420 U	390 U
BENZO(B)FLUORANTHENE	420 U	400 U	440 U	400 U	420 U	390 U
BENZO(K)FLUORANTHENE	420 U	400 U	440 U	400 U	420 U	390 U
BENZO(A)PYRENE	420 U	400 U	440 U	400 U	420 U	390 U
INDENO(1,2,3-CD)PYRENE	420 U	400 U	440 U	400 U	420 U	390 U
DIBENZO(A,H)ANTHRACENE	420 U	400 U	440 U	400 U	420 U	390 U
BENZO(G,H,I)PERYLENE	420 U	400 U	440 U	400 U	420 U	390 U

UG/KG - microgram per kilogram

J - value is estimated

U - not detected

UJ - not detected, value is estimated

* Data Not Validated

TABLE 4-3
SURFACE SOIL - POSITIVE DETECTION SUMMARY
SITE 36, CAMP GEIGER AREA DUMP
REMEDIAL INVESTIGATION, CTO-0303
MCB, CAMP LEJEUNE, NORTH CAROLINA
TCL ORGANICS

LOCATION	36-FCA-SB07-00	36-FCA-SB08-00	36-FCA-SB09-00	36-FCA-SB10-00	36-FCA-SB11-00	36-FCA-SB12-00
DATE SAMPLED	02/22/95	02/27/95	02/22/95	02/22/95	02/23/95	02/22/95
DEPTH	0-12"	0-12"	0-12"	0-12"	0-12"	0-12"
PESTICIDES/PCBs (ug/kg)						
GAMMA-BHC (LINDANE)	2.1 UJ	2 UJ	2.3 UJ	2 UJ	2 UJ	1.9 UJ
HEPTACHLOR	2.1 U	2 UJ	2.3 U	2 UJ	2 UJ	1.9 U
ALDRIN	2.1 U	2 UJ	2.3 U	2 UJ	2 UJ	1.9 U
HEPTACHLOR EPOXIDE	2.1 U	2 UJ	2.3 U	2 UJ	2 UJ	10 J
ENDOSULFAN I	2.1 U	2 UJ	2.3 U	2 UJ	2 UJ	1.9 U
DIELDRIN	4.3 U	4 UJ	4.5 U	47 J	4.1 UJ	3.8 U
4,4'-DDE	11 J	4.8 J	4.5 UJ	150	4.1 UJ	3.8 J
ENDRIN	4.3 U	4 UJ	4.5 U	4 UJ	4.1 UJ	3.8 U
4,4'-DDD	4.3 U	4 UJ	4.5 U	4 UJ	4.1 UJ	3.8 U
ENDOSULFAN SULFATE	4.3 U	4 UJ	4.5 U	4 UJ	4.1 UJ	3.8 U
4,4'-DDT	9.4	4.4 J	4.5 U	51 J	4.1 UJ	2.7 J
ENDRIN KETONE	4.3 U	4 UJ	4.5 U	4 UJ	4.1 UJ	3.8 U
ENDRIN ALDEHYDE	4.3 U	4 UJ	4.5 U	4 UJ	4.1 UJ	3.8 U
ALPHA-CHLORDANE	2.1 U	2 UJ	2.3 U	2 UJ	2 UJ	50 J
GAMMA-CHLORDANE	2.1 U	2 UJ	2.3 U	2 UJ	2 UJ	37
AROCLOR-1248	43 U	40 UJ	45 U	40 UJ	41 UJ	38 U
AROCLOR-1254	43 U	40 UJ	45 U	40 UJ	41 UJ	38 U

UG/KG - microgram per kilogram

J - value is estimated

U - not detected

UJ - not detected, value is estimated

* Data Not Validated

TABLE 4-3
SURFACE SOIL - POSITIVE DETECTION SUMMARY
SITE 36, CAMP GEIGER AREA DUMP
REMEDIAL INVESTIGATION, CTO-0303
MCB, CAMP LEJEUNE, NORTH CAROLINA
TCL ORGANICS

LOCATION	36-FCA-SB13-00	36-FCA-SB14-00	36-FDA-SB01-00	36-FDA-SB02-00	36-FDA-SB03-00	36-FDA-SB04-00
DATE SAMPLED	02/27/95	02/23/95	02/23/95	02/27/95	02/22/95	02/24/95
DEPTH	0-12"	0-12"	0-12"	0-12"	0-12"	0-12"
VOLATILES (ug/kg)						
ACETONE	12 U	13 U	13 U	13 U	28	11 U
TRICHLOROETHENE	12 U	13 U	13 U	13 U	4 J	11 U
TETRACHLOROETHENE	12 U	13 U	13 U	13 U	12 UJ	11 U
TOLUENE	12 U	13 U	13 U	13 U	12 U	11 U
STYRENE	12 U	13 U	13 U	13 U	12 U	11 U
XYLENE (TOTAL)	12 U	13 U	13 U	13 U	12 U	11 U
SEMIVOLATILES (ug/kg)						
N-NITROSO-DI-N-PROPYLAMINE	400 U	410 U	420 U	430 U	410 U	370 R
NAPHTHALENE	400 U	410 U	420 U	430 U	410 U	370 R
2-METHYLNAPHTHALENE	400 U	410 U	420 U	430 U	410 U	370 R
ACENAPHTHENE	400 U	410 U	420 U	430 U	410 U	370 R
DIBENZOFURAN	400 U	410 U	420 U	430 U	410 U	370 R
DIETHYLPHTHALATE	400 U	410 U	420 U	430 U	410 U	370 R
FLUORENE	400 U	410 U	420 U	430 U	410 U	370 R
PHENANTHRENE	400 U	410 U	420 U	430 U	410 U	370 R
ANTHRACENE	400 U	410 U	420 U	430 U	410 U	370 R
CARBAZOLE	400 U	410 U	420 U	430 U	410 U	370 R
FLUORANTHENE	400 U	410 U	420 U	430 U	410 U	370 R
PYRENE	400 U	410 U	420 U	430 U	410 U	370 R
BUTYLBENZYLPHTHALATE	400 U	410 U	420 U	430 U	410 U	370 R
BENZO(A)ANTHRACENE	400 U	410 U	420 U	430 U	410 U	370 R
CHRYSENE	400 U	410 U	420 U	430 U	410 U	370 R
BIS(2-ETHYLHEXYL)PHTHALATE	400 U	410 U	420 U	430 U	250 J	370 R
BENZO(B)FLUORANTHENE	400 U	410 U	420 U	430 U	410 U	370 R
BENZO(K)FLUORANTHENE	400 U	410 U	420 U	430 U	410 U	370 R
BENZO(A)PYRENE	400 U	410 U	420 U	430 U	410 U	370 R
INDENO(1,2,3-CD)PYRENE	400 U	410 U	420 U	430 U	410 U	370 R
DIBENZO(A,H)ANTHRACENE	400 U	410 U	420 U	430 U	410 U	370 R
BENZO(G,H,I)PERYLENE	400 U	410 U	420 U	430 U	410 U	370 R

UG/KG - microgram per kilogram
 J - value is estimated
 U - not detected
 UJ - not detected, value is estimated
 * Data Not Validated

TABLE 4-3
SURFACE SOIL - POSITIVE DETECTION SUMMARY
SITE 36, CAMP GEIGER AREA DUMP
REMEDIAL INVESTIGATION, CTO-0303
MCB, CAMP LEJEUNE, NORTH CAROLINA
TCL ORGANICS

LOCATION	36-FCA-SB13-00	36-FCA-SB14-00	36-FDA-SB01-00	36-FDA-SB02-00	36-FDA-SB03-00	36-FDA-SB04-00
DATE SAMPLED	02/27/95	02/23/95	02/23/95	02/27/95	02/22/95	02/24/95
DEPTH	0-12"	0-12"	0-12"	0-12"	0-12"	0-12"
PESTICIDES/PCBs (ug/kg)						
GAMMA-BHC (LINDANE)	2 U	2.1 UJ	2.1 U	2.2 U	2.1 UJ	1.8 U
HEPTACHLOR	2 U	2.1 U	2.1 U	2.2 UJ	2.1 U	1.8 U
ALDRIN	2 U	2.1 U	2.1 U	2.2 U	2.1 U	1.8 U
HEPTACHLOR EPOXIDE	2 U	2.1 U	2.1 U	2.2 U	2.1 U	1.8 U
ENDOSULFAN I	2 U	2.1 U	2.1 U	2.2 U	2.1 U	1.8 U
DIELDRIN	4 U	4.3 U	4.2 U	4.3 U	27	3.7 U
4,4'-DDE	4 U	5.1 J	100 J	3.5 J	50 J	2.2 J
ENDRIN	4 U	4.3 U	4.2 U	4.3 U	4.2 U	3.7 U
4,4'-DDD	4 U	4.3 U	13 J	4.3 U	43 J	3.7 U
ENDOSULFAN SULFATE	4 U	4.3 U	4.2 U	4.3 U	4.2 U	3.7 U
4,4'-DDT	4 U	6.8 J	49 J	3.9 J	18 J	5.9
ENDRIN KETONE	4 U	4.3 U	4.2 U	4.3 U	4.2 U	3.7 U
ENDRIN ALDEHYDE	4 U	4.3 U	4.2 U	4.3 U	4.2 U	3.7 U
ALPHA-CHLORDANE	2 U	2.1 U	1.7 J	2.2 U	2.1 U	1.8 U
GAMMA-CHLORDANE	2 U	2.1 U	1.3 J	2.2 U	2.1 U	1.8 U
AROCLOR-1248	40 U	43 U	42 U	43 U	42 U	37 U
AROCLOR-1254	40 U	43 U	42 U	43 U	42 U	37 U

UG/KG - microgram per kilogram
 J - value is estimated
 U - not detected
 UJ - not detected, value is estimated
 * Data Not Validated

TABLE 4-3
SURFACE SOIL - POSITIVE DETECTION SUMMARY
SITE 36, CAMP GEIGER AREA DUMP
REMEDIAL INVESTIGATION, CTO-0303
MCB, CAMP LEJEUNE, NORTH CAROLINA
TCL ORGANICS

LOCATION	36-FDA-SB05-00	36-FDA-SB06-00	36-GS-SB01-00	36-GS-SB02-00	36-GS-SB03-00	36-GS-SB04-00
DATE SAMPLED	02/27/95	02/25/95	05/06/95	05/06/95	05/07/95	05/06/95
DEPTH	0-12"	0-12"	0-12"	0-12"	0-12"	0-12"
VOLATILES (ug/kg)						
ACETONE	11 U	12 U	11 U	11 U	11 U	11 U
TRICHLOROETHENE	11 U	12 U	11 U	11 U	11 U	11 U
TETRACHLOROETHENE	11 U	12 U	11 U	11 U	11 UJ	11 UJ
TOLUENE	11 U	12 U	11 U	11 U	11 UJ	11 UJ
STYRENE	11 U	12 U	11 U	11 U	39 J	11 UJ
XYLENE (TOTAL)	11 U	12 U	11 U	11 U	11 UJ	11 UJ
SEMIVOLATILES (ug/kg)						
N-NITROSO-DI-N-PROPYLAMINE	370 U	390 U	370 U	350 U	360 U	360 U
NAPHTHALENE	370 U	390 U	370 U	350 U	360 U	360 U
2-METHYLNAPHTHALENE	370 U	390 U	370 U	350 U	360 U	360 U
ACENAPHTHENE	370 U	390 U	370 U	350 U	360 U	360 U
DIBENZOFURAN	370 U	390 U	370 U	350 U	360 U	360 U
DIETHYLPHTHALATE	370 U	390 U	370 U	350 U	360 U	360 U
FLUORENE	370 U	390 U	370 U	350 U	360 U	360 U
PHENANTHRENE	370 U	390 U	370 U	350 U	360 U	360 U
ANTHRACENE	370 U	390 U	370 U	350 U	360 U	360 U
CARBAZOLE	370 U	390 U	370 U	350 U	360 U	360 U
FLUORANTHENE	370 U	390 U	370 U	350 U	360 U	360 U
PYRENE	370 U	390 U	370 U	350 U	360 U	360 U
BUTYLBENZYLPHTHALATE	370 U	390 U	370 U	350 U	360 U	360 U
BENZO(A)ANTHRACENE	370 U	390 U	370 U	350 U	360 U	360 U
CHRYSENE	370 U	390 U	370 U	350 U	360 U	360 U
BIS(2-ETHYLHEXYL)PHTHALATE	370 U	390 U	370 U	350 U	360 U	360 U
BENZO(B)FLUORANTHENE	370 U	390 U	370 U	350 U	360 U	360 U
BENZO(K)FLUORANTHENE	370 U	390 U	370 U	350 U	360 U	360 U
BENZO(A)PYRENE	370 U	390 U	370 U	350 U	360 U	360 U
INDENO(1,2,3-CD)PYRENE	370 U	390 U	370 U	350 U	360 U	360 U
DIBENZO(A,H)ANTHRACENE	370 U	390 U	370 U	350 U	360 U	360 U
BENZO(G,H,I)PERYLENE	370 U	390 U	370 U	350 U	360 U	360 U

UG/KG - microgram per kilogram

J - value is estimated

U - not detected

UJ - not detected, value is estimated

* Data Not Validated

**TABLE 4-3
SURFACE SOIL - POSITIVE DETECTION SUMMARY
SITE 36, CAMP GEIGER AREA DUMP
REMEDIAL INVESTIGATION, CTO-0303
MCB, CAMP LEJEUNE, NORTH CAROLINA
TCL ORGANICS**

LOCATION	36-FDA-SB05-00	36-FDA-SB06-00	36-GS-SB01-00	36-GS-SB02-00	36-GS-SB03-00	36-GS-SB04-00
DATE SAMPLED	02/27/95	02/25/95	05/06/95	05/06/95	05/07/95	05/06/95
DEPTH	0-12"	0-12"	0-12"	0-12"	0-12"	0-12"
PESTICIDES/PCBs (ug/kg)						
GAMMA-BHC (LINDANE)	1.8 UJ	2 U	NA	NA	NA	NA
HEPTACHLOR	1.8 UJ	2 U	NA	NA	NA	NA
ALDRIN	1.8 UJ	2 U	NA	NA	NA	NA
HEPTACHLOR EPOXIDE	1.8 UJ	2 U	NA	NA	NA	NA
ENDOSULFAN I	1.8 UJ	2 U	NA	NA	NA	NA
DIELDRIN	3.7 UJ	2 J	NA	NA	NA	NA
4,4'-DDE	3.7 UJ	6.7	NA	NA	NA	NA
ENDRIN	3.7 UJ	3.9 U	NA	NA	NA	NA
4,4'-DDD	3.7 UJ	3.5 J	NA	NA	NA	NA
ENDOSULFAN SULFATE	3.7 UJ	3.9 U	NA	NA	NA	NA
4,4'-DDT	1.8 J	7.1	NA	NA	NA	NA
ENDRIN KETONE	3.7 UJ	3.9 U	NA	NA	NA	NA
ENDRIN ALDEHYDE	3.7 UJ	3.9 U	NA	NA	NA	NA
ALPHA-CHLORDANE	1.8 UJ	2 U	NA	NA	NA	NA
GAMMA-CHLORDANE	1.8 UJ	2 U	NA	NA	NA	NA
AROCLOR-1248	37 UJ	39 U	NA	NA	NA	NA
AROCLOR-1254	37 UJ	39 U	NA	NA	NA	NA

UG/KG - microgram per kilogram
 J - value is estimated
 U - not detected
 UJ - not detected, value is estimated
 * Data Not Validated

TABLE 4-3
SURFACE SOIL - POSITIVE DETECTION SUMMARY
SITE 36, CAMP GEIGER AREA DUMP
REMEDIAL INVESTIGATION, CTO-0303
MCB, CAMP LEJEUNE, NORTH CAROLINA
TCL ORGANICS

LOCATION	36-GS-SB05-00	36-GS-SB06-00	36-GW07-00	36-GW09-00	36-GW10-00	36-GW11-00	36-GW12-00
DATE SAMPLED	05/06/95	05/07/95	03/07/95	03/09/95	03/09/95	03/09/95	04/23/95
DEPTH	0-12"	0-12"	0-12"	0-12"	0-12"	0-12"	0-12"
VOLATILES (ug/kg)							
ACETONE	12 U	11 U	12 U	16 U	12 U	12 U	11 U
TRICHLOROETHENE	12 U	11 U	12 U	16 U	12 U	12 U	11 U
TETRACHLOROETHENE	12 U	11 U	12 U	16 UJ	12 U	12 U	3 J
TOLUENE	12 U	11 U	12 U	16 UJ	12 U	12 U	11 U
STYRENE	12 U	11 U	12 U	16 UJ	12 U	12 U	11 U
XYLENE (TOTAL)	12 U	11 U	12 U	16 UJ	12 U	12 U	11 U
SEMIVOLATILES (ug/kg)							
N-NITROSO-DI-N-PROPYLAMINE	380 U	350 U	390 U	510 U	390 U	400 U	NA
NAPHTHALENE	380 U	350 U	390 U	510 U	390 U	400 U	NA
2-METHYLNAPHTHALENE	380 U	350 U	390 U	510 U	390 U	400 U	NA
ACENAPHTHENE	380 U	350 U	390 U	510 U	390 U	400 U	NA
DIBENZOFURAN	380 U	350 U	390 U	510 U	390 U	400 U	NA
DIETHYLPHTHALATE	380 U	350 U	390 U	510 U	390 U	400 U	NA
FLUORENE	380 U	350 U	390 U	510 U	390 U	400 U	NA
PHENANTHRENE	380 U	350 U	390 U	510 U	390 U	400 U	NA
ANTHRACENE	380 U	350 U	390 U	510 U	390 U	400 U	NA
CARBAZOLE	380 U	350 U	390 U	510 U	390 U	400 U	NA
FLUORANTHENE	380 U	350 U	390 U	510 U	390 U	400 U	NA
PYRENE	380 U	350 U	390 U	510 U	390 U	400 U	NA
BUTYLBENZYLPHTHALATE	380 U	350 U	390 U	510 U	390 U	400 U	NA
BENZO(A)ANTHRACENE	380 U	350 U	390 U	510 U	390 U	400 U	NA
CHRYSENE	380 U	350 U	390 U	510 U	390 U	400 U	NA
BIS(2-ETHYLHEXYL)PHTHALATE	380 U	350 U	360 J	160 J	390 U	400 U	NA
BENZO(B)FLUORANTHENE	380 U	350 U	390 U	510 U	390 U	400 U	NA
BENZO(K)FLUORANTHENE	380 U	350 U	390 U	510 U	390 U	400 U	NA
BENZO(A)PYRENE	380 U	350 U	390 U	510 U	390 U	400 U	NA
INDENO(1,2,3-CD)PYRENE	380 U	350 U	390 U	510 U	390 U	400 U	NA
DIBENZO(A,H)ANTHRACENE	380 U	350 U	390 U	510 U	390 U	400 U	NA
BENZO(G,H,I)PERYLENE	380 U	350 U	390 U	510 U	390 U	400 U	NA

UG/KG - microgram per kilogram

J - value is estimated

U - not detected

UJ - not detected, value is estimated

* Data Not Validated

TABLE 4-3
SURFACE SOIL - POSITIVE DETECTION SUMMARY
SITE 36, CAMP GEIGER AREA DUMP
REMEDIAL INVESTIGATION, CTO-0303
MCB, CAMP LEJEUNE, NORTH CAROLINA
TCL ORGANICS

LOCATION	36-GS-SB05-00	36-GS-SB06-00	36-GW07-00	36-GW09-00	36-GW10-00	36-GW11-00	36-GW12-00
DATE SAMPLED	05/06/95	05/07/95	03/07/95	03/09/95	03/09/95	03/09/95	04/23/95
DEPTH	0-12"	0-12"	0-12"	0-12"	0-12"	0-12"	0-12"
PESTICIDES/PCBs (ug/kg)							
GAMMA-BHC (LINDANE)	NA	NA	2 U	2.6 UJ	2 U	2 UJ	NA
HEPTACHLOR	NA	NA	2 U	2.6 UJ	2 U	2 UJ	NA
ALDRIN	NA	NA	2 U	2.6 UJ	2 U	2 UJ	NA
HEPTACHLOR EPOXIDE	NA	NA	2 U	2.6 UJ	2 U	2 UJ	NA
ENDOSULFAN I	NA	NA	2 U	2.6 UJ	2 U	2 UJ	NA
DIELDRIN	NA	NA	3.9 U	5.2 UJ	3.9 U	4 UJ	NA
4,4'-DDE	NA	NA	13	10 J	3.9 U	30 J	NA
ENDRIN	NA	NA	3.9 U	5.2 UJ	3.9 U	4 UJ	NA
4,4'-DDD	NA	NA	3.9 U	3.7 J	3.9 U	15 J	NA
ENDOSULFAN SULFATE	NA	NA	3.9 U	5.2 UJ	3.9 U	4 UJ	NA
4,4'-DDT	NA	NA	5.1	5.2 UJ	3.9 U	18 J	NA
ENDRIN KETONE	NA	NA	3.9 U	5.2 UJ	3.9 U	4 UJ	NA
ENDRIN ALDEHYDE	NA	NA	3.9 U	5.2 UJ	3.9 U	4 UJ	NA
ALPHA-CHLORDANE	NA	NA	2 U	2.6 UJ	2 U	1.2 J	NA
GAMMA-CHLORDANE	NA	NA	2 U	2.6 UJ	2 U	1.2 J	NA
AROCLOR-1248	NA	NA	39 U	52 UJ	39 U	40 UJ	NA
AROCLOR-1254	NA	NA	39 U	52 UJ	39 U	40 UJ	NA

UG/KG - microgram per kilogram
 J - value is estimated
 U - not detected
 UJ - not detected, value is estimated
 * Data Not Validated

TABLE 4-3
SURFACE SOIL - POSITIVE DETECTION SUMMARY
SITE 36, CAMP GEIGER AREA DUMP
REMEDIAL INVESTIGATION, CTO-0303
MCB, CAMP LEJEUNE, NORTH CAROLINA
TCL ORGANICS

LOCATION	36-GW13-00	36-GW14-00	36-OA-SB01-00	36-OA-SB01A-00	36-OA-SB01B-00	36-OA-SB01C-00
DATE SAMPLED	04/24/95	04/24/95	02/22/95	03/09/95	03/09/95	03/09/95
DEPTH	0-12"	0-12"	0-12"	0-12"	0-12"	0-12"
VOLATILES (ug/kg)						
ACETONE	11 U	10 U	12 U	12 U	12 U	12 U
TRICHLOROETHENE	11 U	10 U	12 U	12 U	12 U	12 U
TETRACHLOROETHENE	2 J	2 J	12 U	12 UJ	12 U	12 U
TOLUENE	11 U	10 U	12 U	12 UJ	12 U	12 U
STYRENE	11 U	10 U	12 U	12 UJ	12 U	12 U
XYLENE (TOTAL)	11 U	10 U	12 U	12 UJ	12 U	12 U
SEMIVOLATILES (ug/kg)						
N-NITROSO-DI-N-PROPYLAMINE	NA	NA	400 U	400 U	400 U	410 U
NAPHTHALENE	NA	NA	400 U	48 J	400 U	410 U
2-METHYLNAPHTHALENE	NA	NA	400 U	82 J	400 U	410 U
ACENAPHTHENE	NA	NA	400 U	400 U	400 U	410 U
DIBENZOFURAN	NA	NA	400 U	400 U	400 U	410 U
DIETHYLPHTHALATE	NA	NA	400 U	400 U	400 U	410 U
FLUORENE	NA	NA	400 U	400 U	400 U	410 U
PHENANTHRENE	NA	NA	400 U	120 J	400 U	410 U
ANTHRACENE	NA	NA	400 U	400 U	400 U	410 U
CARBAZOLE	NA	NA	400 U	400 U	400 U	410 U
FLUORANTHENE	NA	NA	400 U	400 U	400 U	410 U
PYRENE	NA	NA	400 U	400 U	400 U	410 U
BUTYLBENZYLPHthalATE	NA	NA	400 U	400 U	400 U	410 U
BENZO(A)ANTHRACENE	NA	NA	400 U	400 U	400 U	410 U
CHRYSENE	NA	NA	400 U	91 J	400 U	410 U
BIS(2-ETHYLHEXYL)PHTHALATE	NA	NA	46 J	400 U	400 U	410 U
BENZO(B)FLUORANTHENE	NA	NA	400 U	51 J	400 U	410 U
BENZO(K)FLUORANTHENE	NA	NA	400 U	400 U	400 U	410 U
BENZO(A)PYRENE	NA	NA	400 U	40 J	400 U	410 U
INDENO(1,2,3-CD)PYRENE	NA	NA	400 U	400 U	400 U	410 U
DIBENZO(A,H)ANTHRACENE	NA	NA	400 U	400 U	400 U	410 U
BENZO(G,H,I)PERYLENE	NA	NA	400 U	400 U	400 U	410 U

UG/KG - microgram per kilogram
 J - value is estimated
 U - not detected
 UJ - not detected, value is estimated
 * Data Not Validated

TABLE 4-3
SURFACE SOIL - POSITIVE DETECTION SUMMARY
SITE 36, CAMP GEIGER AREA DUMP
REMEDIAL INVESTIGATION, CTO-0303
MCB, CAMP LEJEUNE, NORTH CAROLINA
TCL ORGANICS

LOCATION	36-GW13-00	36-GW14-00	36-OA-SB01-00	36-OA-SB01A-00	36-OA-SB01B-00	36-OA-SB01C-00
DATE SAMPLED	04/24/95	04/24/95	02/22/95	03/09/95	03/09/95	03/09/95
DEPTH	0-12"	0-12"	0-12"	0-12"	0-12"	0-12"
PESTICIDES/PCBs (ug/kg)						
GAMMA-BHC (LINDANE)	NA	NA	2 UJ	100 U	2 U	2 U
HEPTACHLOR	NA	NA	2 U	100 U	2 U	2 U
ALDRIN	NA	NA	2 U	100 U	2 U	2 U
HEPTACHLOR EPOXIDE	NA	NA	2 U	100 U	3.9 J	2.4 J
ENDOSULFAN I	NA	NA	2 U	100 U	2 U	2 U
DIELDRIN	NA	NA	58 J	200 U	6.3	3.6 J
4,4'-DDE	NA	NA	110 J	2600	42 J	300
ENDRIN	NA	NA	4 U	200 U	3.9 U	4 U
4,4'-DDD	NA	NA	22	550 J	4.7 J	21 J
ENDOSULFAN SULFATE	NA	NA	4 U	200 U	3.9 U	4 U
4,4'-DDT	NA	NA	61 J	12000	20	170
ENDRIN KETONE	NA	NA	4 U	200 U	3.9 U	4 U
ENDRIN ALDEHYDE	NA	NA	4 U	200 U	3.9 U	4 U
ALPHA-CHLORDANE	NA	NA	2 U	100 U	2.4 J	2 U
GAMMA-CHLORDANE	NA	NA	2 U	100 U	2 U	2 U
AROCLOR-1248	NA	NA	1400	2000 U	810	440
AROCLOR-1254	NA	NA	530 J	2000 U	39 U	40 U

UG/KG - microgram per kilogram
 J - value is estimated
 U - not detected
 UJ - not detected, value is estimated
 * Data Not Validated

TABLE 4-3
SURFACE SOIL - POSITIVE DETECTION SUMMARY
SITE 36, CAMP GEIGER AREA DUMP
REMEDIAL INVESTIGATION, CTO-0303
MCB, CAMP LEJEUNE, NORTH CAROLINA
TCL ORGANICS

LOCATION	36-OA-SB01D-00	36-OA-SB01E-00	36-OA-SB01F-00	36-OA-SB01G-00	36-OA-SB01H-00	36-OA-SB01I-00
DATE SAMPLED	03/09/95	10/09/95	10/09/95	10/09/95	10/09/95	10/09/95
DEPTH	0-12"	0-12"	0-12"	0-12"	0-12"	0-12"
VOLATILES (ug/kg)						
ACETONE	12 U	NA	NA	NA	NA	NA
TRICHLOROETHENE	12 U	NA	NA	NA	NA	NA
TETRACHLOROETHENE	12 U	NA	NA	NA	NA	NA
TOLUENE	12 U	NA	NA	NA	NA	NA
STYRENE	12 U	NA	NA	NA	NA	NA
XYLENE (TOTAL)	12 U	NA	NA	NA	NA	NA
SEMIVOLATILES (ug/kg)						
N-NITROSO-DI-N-PROPYLAMINE	390 U	NA	NA	NA	NA	NA
NAPHTHALENE	390 U	NA	NA	NA	NA	NA
2-METHYLNAPHTHALENE	390 U	NA	NA	NA	NA	NA
ACENAPHTHENE	390 U	NA	NA	NA	NA	NA
DIBENZOFURAN	390 U	NA	NA	NA	NA	NA
DIETHYLPHTHALATE	390 U	NA	NA	NA	NA	NA
FLUORENE	390 U	NA	NA	NA	NA	NA
PHENANTHRENE	390 U	NA	NA	NA	NA	NA
ANTHRACENE	390 U	NA	NA	NA	NA	NA
CARBAZOLE	390 U	NA	NA	NA	NA	NA
FLUORANTHENE	390 U	NA	NA	NA	NA	NA
PYRENE	390 U	NA	NA	NA	NA	NA
BUTYLBENZYLPHTHALATE	390 U	NA	NA	NA	NA	NA
BENZO(A)ANTHRACENE	390 U	NA	NA	NA	NA	NA
CHRYSENE	390 U	NA	NA	NA	NA	NA
BIS(2-ETHYLHEXYL)PHTHALATE	390 U	NA	NA	NA	NA	NA
BENZO(B)FLUORANTHENE	390 U	NA	NA	NA	NA	NA
BENZO(K)FLUORANTHENE	390 U	NA	NA	NA	NA	NA
BENZO(A)PYRENE	390 U	NA	NA	NA	NA	NA
INDENO(1,2,3-CD)PYRENE	390 U	NA	NA	NA	NA	NA
DIBENZO(A,H)ANTHRACENE	390 U	NA	NA	NA	NA	NA
BENZO(G,H,I)PERYLENE	390 U	NA	NA	NA	NA	NA

UG/KG - microgram per kilogram
J - value is estimated
U - not detected
UJ - not detected, value is estimated
* Data Not Validated

TABLE 4-3
SURFACE SOIL - POSITIVE DETECTION SUMMARY
SITE 36, CAMP GEIGER AREA DUMP
REMEDIAL INVESTIGATION, CTO-0303
MCB, CAMP LEJEUNE, NORTH CAROLINA
TCL ORGANICS

LOCATION	36-OA-SB01D-00	36-OA-SB01E-00	36-OA-SB01F-00	36-OA-SB01G-00	36-OA-SB01H-00	36-OA-SB01I-00
DATE SAMPLED	03/09/95	10/09/95	10/09/95	10/09/95	10/09/95	10/09/95
DEPTH	0-12"	0-12"	0-12"	0-12"	0-12"	0-12"
PESTICIDES/PCBs (ug/kg)						
GAMMA-BHC (LINDANE)	2 U	2 UJ	2.2 U	2 U	2 UJ	22 U
HEPTACHLOR	2 U	2 UJ	2.2 U	2 U	2 UJ	22 U
ALDRIN	2 U	7.1 J	2.2 U	2 U	5.5 J	22 U
HEPTACHLOR EPOXIDE	2 J	6.7 J	2.2 U	2 U	6.3 J	67 J
ENDOSULFAN I	2 U	36 J	8.3 J	2 U	31 J	430 U
DIELDRIN	3.9 U	36 J	5.2 J	4 U	30 J	430 U
4,4'-DDE	29 J	59 J	42 J	40 UJ	65 J	420 J
ENDRIN	3.9 U	4 UJ	4.4 U	4 U	4 UJ	43 U
4,4'-DDD	6.7 J	14 J	13 J	4 U	12 J	99
ENDOSULFAN SULFATE	3.9 U	4 UJ	4.4 U	4 U	4 UJ	43 U
4,4'-DDT	20	25 J	16 J	19 J	20 J	340 J
ENDRIN KETONE	3.9 U	4 UJ	4.4 U	4 U	4 UJ	43 U
ENDRIN ALDEHYDE	3.9 U	4 UJ	4.4 U	4 U	4 UJ	43 U
ALPHA-CHLORDANE	2 U	29 J	7 J	12 J	34 J	430 U
GAMMA-CHLORDANE	2 U	2 UJ	2.2 U	6.7 J	2 UJ	22 U
AROCLOR-1248	350	2400	350 J	68 J	1500	24000
AROCLOR-1254	39 U	40 UJ	44 U	40 U	40 UJ	430 U

UG/KG - microgram per kilogram

J - value is estimated

U - not detected

UJ - not detected, value is estimated

* Data Not Validated

TABLE 4-3
SURFACE SOIL - POSITIVE DETECTION SUMMARY
SITE 36, CAMP GEIGER AREA DUMP
REMEDIAL INVESTIGATION, CTO-0303
MCB, CAMP LEJEUNE, NORTH CAROLINA
TCL ORGANICS

LOCATION	36-OA-SB02-00	36-OA-SB03-00	36-OA-SB04-00	36-OA-SB05-00	36-OA-SB06-00	36-OA-SB07-00
DATE SAMPLED	02/25/95	02/25/95	02/24/95	02/28/95	02/27/95	02/24/95
DEPTH	0-12"	0-12"	0-12"	0-12"	0-12"	0-12"
VOLATILES (ug/kg)						
ACETONE	14 U	12 U	12 U	12 U	12 U	13 U
TRICHLOROETHENE	14 U	12 U	12 UJ	12 U	12 UJ	13 U
TETRACHLOROETHENE	14 U	12 U	12 UJ	12 UJ	12 UJ	13 U
TOLUENE	14 U	12 U	12 UJ	12 UJ	12 UJ	13 U
STYRENE	14 U	12 U	12 UJ	12 UJ	12 UJ	13 U
XYLENE (TOTAL)	14 U	12 U	12 UJ	12 UJ	12 UJ	13 U
SEMIVOLATILES (ug/kg)						
N-NITROSO-DI-N-PROPYLAMINE	460 U	380 U	410 U	470 U	410 U	420 U
NAPHTHALENE	460 U	380 U	410 U	470 U	410 U	420 U
2-METHYLNAPHTHALENE	460 U	380 U	410 U	470 U	410 U	420 U
ACENAPHTHENE	460 U	380 U	410 U	470 U	410 U	420 U
DIBENZOFURAN	460 U	380 U	410 U	470 U	410 U	420 U
DIETHYLPHTHALATE	460 U	380 U	410 U	470 U	410 U	420 U
FLUORENE	460 U	380 U	410 U	470 U	410 U	420 U
PHENANTHRENE	460 U	380 U	410 U	470 U	410 U	420 U
ANTHRACENE	460 U	380 U	410 U	470 U	410 U	420 U
CARBAZOLE	460 U	380 U	410 U	470 U	410 U	420 U
FLUORANTHENE	460 U	380 U	410 U	470 U	410 U	420 U
PYRENE	460 U	380 U	53 J	470 UJ	410 UJ	420 UJ
BUTYLBENZYLPHTHALATE	110 J	290 J	51 J	470 UJ	410 UJ	420 UJ
BENZO(A)ANTHRACENE	460 U	380 U	410 UJ	470 UJ	410 UJ	420 UJ
CHRYSENE	460 U	380 U	410 UJ	470 UJ	410 UJ	420 UJ
BIS(2-ETHYLHEXYL)PHTHALATE	460 U	380 U	630 J	670 J	410 UJ	55 J
BENZO(B)FLUORANTHENE	460 U	380 U	410 U	470 U	410 U	420 U
BENZO(K)FLUORANTHENE	460 U	380 U	410 U	470 U	410 U	420 U
BENZO(A)PYRENE	460 U	380 U	410 U	470 U	410 U	420 U
INDENO(1,2,3-CD)PYRENE	460 U	380 U	46 J	470 U	410 U	420 U
DIBENZO(A,H)ANTHRACENE	460 U	380 U	410 U	470 U	410 U	420 U
BENZO(G,H,I)PERYLENE	460 U	380 U	410 U	470 U	410 U	420 U

UG/KG - microgram per kilogram

J - value is estimated

U - not detected

UJ - not detected, value is estimated

* Data Not Validated

TABLE 4-3
SURFACE SOIL - POSITIVE DETECTION SUMMARY
SITE 36, CAMP GEIGER AREA DUMP
REMEDIAL INVESTIGATION, CTO-0303
MCB, CAMP LEJEUNE, NORTH CAROLINA
TCL ORGANICS

LOCATION	36-OA-SB02-00	36-OA-SB03-00	36-OA-SB04-00	36-OA-SB05-00	36-OA-SB06-00	36-OA-SB07-00
DATE SAMPLED	02/25/95	02/25/95	02/24/95	02/28/95	02/27/95	02/24/95
DEPTH	0-12"	0-12"	0-12"	0-12"	0-12"	0-12"
PESTICIDES/PCBs (ug/kg)						
GAMMA-BHC (LINDANE)	2.3 U	1.9 U	2.1 U	2.4 UJ	2.1 UJ	2.1 U
HEPTACHLOR	2.3 U	1.9 UJ	2.1 U	2.4 UJ	2.1 UJ	2.1 U
ALDRIN	2.3 U	1.9 U	2.1 U	2.4 UJ	2.1 UJ	2.1 U
HEPTACHLOR EPOXIDE	2.3 U	1.9 U	2.1 U	24 J	2.1 UJ	2.1 U
ENDOSULFAN I	2.3 U	1.9 U	2.1 U	2.4 UJ	2.1 UJ	2.1 U
DIELDRIN	27	3.8 U	4.1 U	160 J	4.1 J	4.2 U
4,4'-DDE	170 J	3.8 U	95 J	1000	18 J	210
ENDRIN	4.6 U	3.8 U	4.1 U	4.8 UJ	4.1 UJ	4.2 U
4,4'-DDD	4.6 U	3.8 U	9.4 J	230 J	4.1 UJ	37
ENDOSULFAN SULFATE	4.6 U	3.8 U	2.5 J	4.8 UJ	4.1 UJ	4.2 U
4,4'-DDT	84 J	3.8 U	49 J	420	17 J	120
ENDRIN KETONE	4.6 U	3.8 U	4.1 U	4.8 UJ	4.1 UJ	4.2 U
ENDRIN ALDEHYDE	4.6 U	3.8 U	4.1 U	4.8 UJ	4.1 UJ	4.2 U
ALPHA-CHLORDANE	2.3 U	1.9 U	2.1 U	980	2.1 UJ	2.5
GAMMA-CHLORDANE	2.3 U	1.9 U	2.1 U	840	2.1 UJ	2.1 U
AROCLOR-1248	46 U	38 U	41 U	48 UJ	41 UJ	42 U
AROCLOR-1254	46 U	38 U	41 U	48 UJ	41 UJ	42 U

UG/KG - microgram per kilogram
 J - value is estimated
 U - not detected
 UJ - not detected, value is estimated
 * Data Not Validated

TABLE 4-3
SURFACE SOIL - POSITIVE DETECTION SUMMARY
SITE 36, CAMP GEIGER AREA DUMP
REMEDIAL INVESTIGATION, CTO-0303
MCB, CAMP LEJEUNE, NORTH CAROLINA
TCL ORGANICS

LOCATION	36-OA-SB08-00	36-OF-SB01-00	36-OF-SB02-00	36-OF-SB03-00	36-OF-SB04-00	36-OF-SB05-00
DATE SAMPLED	02/27/95	02/21/95	02/21/95	02/21/95	02/22/95	02/21/95
DEPTH	0-12"	0-12"	0-12"	0-12"	0-12"	0-12"
VOLATILES (ug/kg)						
ACETONE	24 J	12 U	12 U	12 U	12 U	11 U
TRICHLOROETHENE	12 UJ	12 UJ	12 U	12 U	12 U	11 U
TETRACHLOROETHENE	12 UJ	12 U	12 U	12 U	12 U	11 U
TOLUENE	12 UJ	98	12 U	8 J	12 U	11
STYRENE	12 UJ	12 U	12 U	12 U	12 U	11 U
XYLENE (TOTAL)	12 UJ	12 U	12 U	12 U	12 U	11 U
SEMIVOLATILES (ug/kg)						
N-NITROSO-DI-N-PROPYLAMINE	410 U	370 U	400 U	380 U	390 U	370 U
NAPHTHALENE	410 U	370 U	400 U	380 U	120 J	370 U
2-METHYLNAPHTHALENE	410 U	370 U	400 U	380 U	54 J	370 U
ACENAPHTHENE	410 U	370 U	400 U	380 U	330 J	370 U
DIBENZOFURAN	410 U	370 U	400 U	380 U	150 J	370 U
DIETHYLPHTHALATE	410 U	370 U	400 U	380 U	390 U	370 U
FLUORENE	410 U	370 U	400 U	380 U	200 J	370 U
PHENANTHRENE	410 U	370 U	400 U	380 UJ	2500	370 U
ANTHRACENE	410 U	370 U	400 U	380 UJ	780	370 U
CARBAZOLE	410 U	370 U	400 U	380 UJ	240 J	370 U
FLUORANTHENE	410 U	370 U	400 U	380 UJ	5500	370 U
PYRENE	410 U	370 U	400 U	380 UJ	11000 J	370 U
BUTYLBENZYLPHTHALATE	410 U	370 U	400 U	380 UJ	390 UJ	370 U
BENZO(A)ANTHRACENE	410 U	370 U	400 U	380 UJ	3900 J	370 U
CHRYSENE	410 U	370 U	400 U	380 UJ	4600 J	370 U
BIS(2-ETHYLHEXYL)PHTHALATE	410 U	380	190 J	380 UJ	480 J	370 U
BENZO(B)FLUORANTHENE	410 U	370 U	400 U	380 UJ	3600	370 U
BENZO(K)FLUORANTHENE	410 U	370 U	400 U	380 UJ	1500	370 U
BENZO(A)PYRENE	410 U	370 U	400 U	380 UJ	3300	370 U
INDENO(1,2,3-CD)PYRENE	410 U	370 U	400 U	380 UJ	2700	370 U
DIBENZO(A,H)ANTHRACENE	410 U	370 U	400 U	380 UJ	720	370 U
BENZO(G,H,I)PERYLENE	410 U	370 U	400 U	380 UJ	2400	370 U

UG/KG - microgram per kilogram

J - value is estimated

U - not detected

UJ - not detected, value is estimated

* Data Not Validated

TABLE 4-3
SURFACE SOIL - POSITIVE DETECTION SUMMARY
SITE 36, CAMP GEIGER AREA DUMP
REMEDIAL INVESTIGATION, CTO-0303
MCB, CAMP LEJEUNE, NORTH CAROLINA
TCL ORGANICS

LOCATION	36-OA-SB08-00	36-OF-SB01-00	36-OF-SB02-00	36-OF-SB03-00	36-OF-SB04-00	36-OF-SB05-00
DATE SAMPLED	02/27/95	02/21/95	02/21/95	02/21/95	02/22/95	02/21/95
DEPTH	0-12"	0-12"	0-12"	0-12"	0-12"	0-12"
PESTICIDES/PCBs (ug/kg)						
GAMMA-BHC (LINDANE)	2.1 UJ	1.9 UJ	2 UJ	1.9 UJ	1.9 UJ	1.8 UJ
HEPTACHLOR	2.1 UJ	1.9 U	2 UJ	1.9 UJ	1.9 UJ	1.8 UJ
ALDRIN	2.1 UJ	1.9 U	2 UJ	1400	1.9 UJ	1.8 UJ
HEPTACHLOR EPOXIDE	2.1 UJ	1.9 U	2 UJ	1.9 UJ	7.7 J	1.8 UJ
ENDOSULFAN I	2.1 UJ	1.9 U	2 UJ	1.9 UJ	1.9 UJ	1.8 UJ
DIELDRIN	4.1 UJ	3.8 U	4 UJ	16000	47 J	11 J
4,4'-DDE	650 J	12 J	41 J	11 J	1000	180 J
ENDRIN	9.9 J	3.8 U	4 UJ	3.9 UJ	3.9 UJ	3.7 UJ
4,4'-DDD	76 J	7.5 J	13 J	16 J	160	50 J
ENDOSULFAN SULFATE	4.1 UJ	3.8 U	4 UJ	3.9 UJ	3.9 UJ	3.7 UJ
4,4'-DDT	370	9 J	4 UJ	2.3 J	170	35 J
ENDRIN KETONE	4.1 UJ	3.8 U	4 UJ	15 J	3.9 UJ	3.7 UJ
ENDRIN ALDEHYDE	4.1 UJ	3.8 U	12 J	3.9 UJ	3.9 UJ	3.7 UJ
ALPHA-CHLORDANE	14 J	1.9 U	2 UJ	2.3 J	1.9 UJ	1.8 UJ
GAMMA-CHLORDANE	16 J	1.9 U	2 UJ	1.9 UJ	1.9 UJ	2.6 J
AROCLOR-1248	41 UJ	38 U	40 UJ	39 UJ	39 UJ	37 UJ
AROCLOR-1254	41 UJ	38 U	210 J	39 UJ	39 UJ	37 UJ

UG/KG - microgram per kilogram

J - value is estimated

U - not detected

UJ - not detected, value is estimated

* Data Not Validated

TABLE 4-3
SURFACE SOIL - POSITIVE DETECTION SUMMARY
SITE 36, CAMP GEIGER AREA DUMP
REMEDIAL INVESTIGATION, CTO-0303
MCB, CAMP LEJEUNE, NORTH CAROLINA
TCL ORGANICS

LOCATION	36-OF-SB06-00	36-OF-SB06A-00	36-OF-SB06B-00	36-OF-SB06C-00	36-OF-SB06D-00	36-OF-SB04A*
DATE SAMPLED	02/21/95	03/09/95	03/09/95	03/09/95	03/09/95	05/31/96
DEPTH	0-12"	0-12"	0-12"	0-12"	0-12"	0-12"
VOLATILES (ug/kg)						
ACETONE	13 U	15 U	18 U	13 U	16 U	NA
TRICHLOROETHENE	13 UJ	15 U	18 U	13 U	16 U	NA
TETRACHLOROETHENE	13 U	15 U	18 U	13 U	16 UJ	NA
TOLUENE	50	15 U	18 U	13 U	16 UJ	NA
STYRENE	13 U	15 U	18 U	13 U	16 UJ	NA
XYLENE (TOTAL)	13 U	15 U	7 J	13 U	16 UJ	NA
SEMIVOLATILES (ug/kg)						
N-NITROSO-DI-N-PROPYLAMINE	430 U	500 U	580 U	420 U	540 U	420 U
NAPHTHALENE	430 U	500 U	580 U	420 U	540 U	420 U
2-METHYLNAPHTHALENE	430 U	500 U	580 U	420 U	540 U	420 U
ACENAPHTHENE	430 U	500 U	580 U	420 U	540 U	150 J
DIBENZOFURAN	430 U	500 U	580 U	420 U	540 U	100 J
DIETHYLPHTHALATE	430 U	500 U	580 U	420 U	540 U	420 U
FLUORENE	430 U	500 U	580 U	420 U	540 U	100 J
PHENANTHRENE	430 U	500 U	580 U	420 U	540 U	2800
ANTHRACENE	430 U	500 U	580 U	420 U	540 U	740
CARBAZOLE	430 U	500 U	580 U	420 U	540 U	420 U
FLUORANTHENE	430 U	500 U	580 U	420 U	540 U	3400
PYRENE	430 U	500 U	580 U	420 U	90 J	3800
BUTYLBENZYLPHTHALATE	430 U	500 U	580 U	420 U	540 U	99 J
BENZO(A)ANTHRACENE	430 U	500 U	580 U	420 U	540 U	2100
CHRYSENE	430 U	500 U	580 U	420 U	540 U	1900
BIS(2-ETHYLHEXYL)PHTHALATE	410 J	500 U	580 U	420 U	540 U	690
BENZO(B)FLUORANTHENE	430 U	500 U	580 U	420 U	540 U	3000
BENZO(K)FLUORANTHENE	430 U	500 U	580 U	420 U	540 U	990
BENZO(A)PYRENE	430 U	500 U	580 U	420 U	540 U	1900
INDENO(1,2,3-CD)PYRENE	430 U	500 U	580 U	420 U	540 U	1300
DIBENZO(A,H)ANTHRACENE	430 U	500 U	580 U	420 U	540 U	360 J
BENZO(G,H,I)PERYLENE	430 U	500 U	580 U	420 U	540 U	980

UG/KG - microgram per kilogram

J - value is estimated

U - not detected

UJ - not detected, value is estimated

* Data Not Validated

TABLE 4-3
SURFACE SOIL - POSITIVE DETECTION SUMMARY
SITE 36, CAMP GEIGER AREA DUMP
REMEDIAL INVESTIGATION, CTO-0303
MCB, CAMP LEJEUNE, NORTH CAROLINA
TCL ORGANICS

LOCATION	36-OF-SB06-00	36-OF-SB06A-00	36-OF-SB06B-00	36-OF-SB06C-00	36-OF-SB06D-00	36-OF-SB04A*
DATE SAMPLED	02/21/95	03/09/95	03/09/95	03/09/95	03/09/95	05/31/96
DEPTH	0-12"	0-12"	0-12"	0-12"	0-12"	0-12"
PESTICIDES/PCBs (ug/kg)						
GAMMA-BHC (LINDANE)	2.1 UJ	2.5 UJ	2.9 UJ	2.1 UJ	4	NA
HEPTACHLOR	2.1 U	2.5 UJ	2.9 UJ	2.1 UJ	2.7 UJ	NA
ALDRIN	2.1 U	2.5 UJ	2.9 UJ	2.1 UJ	2.7 UJ	NA
HEPTACHLOR EPOXIDE	2.1 U	2.5 UJ	2.9 UJ	2.1 UJ	2.7 UJ	NA
ENDOSULFAN I	2.1 U	2.5 UJ	2.9 UJ	2.1 UJ	2.7 UJ	NA
DIELDRIN	6.3	5 UJ	5.8 UJ	11 J	5.4 UJ	NA
4,4'-DDE	100 J	23 J	14 J	110	11 J	NA
ENDRIN	4.2 U	5 UJ	5.8 UJ	4.1 UJ	5.4 UJ	NA
4,4'-DDD	85 J	11 J	5.2 J	240	3.2 J	NA
ENDOSULFAN SULFATE	4.2 J	5 UJ	5.8 UJ	4.1 UJ	5.4 UJ	NA
4,4'-DDT	26 J	30 J	23 J	120	7.6 J	NA
ENDRIN KETONE	4.2 U	5 UJ	5.8 UJ	4.1 UJ	5.4 UJ	NA
ENDRIN ALDEHYDE	4.2 U	5 UJ	5.8 UJ	4.1 UJ	5.4 UJ	NA
ALPHA-CHLORDANE	7.2	2.5 UJ	2.9 UJ	3.3 J	2.7 UJ	NA
GAMMA-CHLORDANE	7.6	2.5 UJ	2.9 UJ	1.7 J	2.7 UJ	NA
AROCLOR-1248	42 U	50 UJ	58 UJ	41 UJ	54 UJ	NA
AROCLOR-1254	92	50 UJ	58 UJ	41 UJ	54 UJ	NA

UG/KG - microgram per kilogram
 J - value is estimated
 U - not detected
 UJ - not detected, value is estimated
 * Data Not Validated

TABLE 4-3
SURFACE SOIL - POSITIVE DETECTION SUMMARY
SITE 36, CAMP GEIGER AREA DUMP
REMEDIAL INVESTIGATION, CTO-0303
MCB, CAMP LEJEUNE, NORTH CAROLINA
TCL ORGANICS

LOCATION	36-OF-SB04B*	36-OF-SB04C*	36-OF-SB04D*	36-OA-SB01L*	36-OA-SB01M*	36-OA-SB01J*
DATE SAMPLED	05/31/96	05/31/96	05/31/96	05/31/96	05/31/96	05/31/96
DEPTH	0-12"	0-12"	0-12"	0-12"	0-12"	0-12"
VOLATILES (ug/kg)						
ACETONE	NA	NA	NA	NA	NA	NA
TRICHLOROETHENE	NA	NA	NA	NA	NA	NA
TETRACHLOROETHENE	NA	NA	NA	NA	NA	NA
TOLUENE	NA	NA	NA	NA	NA	NA
STYRENE	NA	NA	NA	NA	NA	NA
XYLENE (TOTAL)	NA	NA	NA	NA	NA	NA
SEMIVOLATILES (ug/kg)						
N-NITROSO-DI-N-PROPYLAMINE	1800 U	390 U	380 U	NA	NA	NA
NAPHTHALENE	820 J	390 U	380 U	NA	NA	NA
2-METHYLNAPHTHALENE	1000 J	390 U	380 U	NA	NA	NA
ACENAPHTHENE	4200	390 U	380 U	NA	NA	NA
DIBENZOFURAN	2400	390 U	380 U	NA	NA	NA
DIETHYLPHTHALATE	1800 U	390 U	160 J	NA	NA	NA
FLUORENE	2200	390 U	380 U	NA	NA	NA
PHENANTHRENE	29000	390 U	76 J	NA	NA	NA
ANTHRACENE	8400	390 U	380 U	NA	NA	NA
CARBAZOLE	2600	390 U	380 U	NA	NA	NA
FLUORANTHENE	52000	61 J	160 J	NA	NA	NA
PYRENE	58000	63 J	170 J	NA	NA	NA
BUTYLBENZYLPHTHALATE	1800 U	390 U	380 U	NA	NA	NA
BENZO(A)ANTHRACENE	39000	39 J	120 J	NA	NA	NA
CHRYSENE	44000	62 J	160 J	NA	NA	NA
BIS(2-ETHYLHEXYL)PHTHALATE	1800 U	150 J	380 U	NA	NA	NA
BENZO(B)FLUORANTHENE	64000	84 J	180 J	NA	NA	NA
BENZO(K)FLUORANTHENE	12000	390 U	80 J	NA	NA	NA
BENZO(A)PYRENE	43000	50 J	110 J	NA	NA	NA
INDENO(1,2,3-CD)PYRENE	35000	390 U	71 J	NA	NA	NA
DIBENZO(A,H)ANTHRACENE	5700	390 U	380 U	NA	NA	NA
BENZO(G,H,I)PERYLENE	31000	390 U	70 J	NA	NA	NA

UG/KG - microgram per kilogram

J - value is estimated

U - not detected

UJ - not detected, value is estimated

* Data Not Validated

TABLE 4-3
SURFACE SOIL - POSITIVE DETECTION SUMMARY
SITE 36, CAMP GEIGER AREA DUMP
REMEDIAL INVESTIGATION, CTO-0303
MCB, CAMP LEJEUNE, NORTH CAROLINA
TCL ORGANICS

LOCATION	36-OF-SB04B*	36-OF-SB04C*	36-OF-SB04D*	36-OA-SB01L*	36-OA-SB01M*	36-OA-SB01J*
DATE SAMPLED	05/31/96	05/31/96	05/31/96	05/31/96	05/31/96	05/31/96
DEPTH	0-12"	0-12"	0-12"	0-12"	0-12"	0-12"
PESTICIDES/PCBs (ug/kg)						
GAMMA-BHC (LINDANE)	NA	NA	NA	1.8 U	1.8 U	NA
HEPTACHLOR	NA	NA	NA	1.8 U	1.8 U	NA
ALDRIN	NA	NA	NA	1.8 U	1.8 U	NA
HEPTACHLOR EPOXIDE	NA	NA	NA	49	180	NA
ENDOSULFAN I	NA	NA	NA	1.8 U	1.8 U	NA
DIELDRIN	NA	NA	NA	3.6 U	3.7 U	NA
4,4'-DDE	NA	NA	NA	250	200	NA
ENDRIN	NA	NA	NA	3.6 U	3.7 U	NA
4,4'-DDD	NA	NA	NA	21	50	NA
ENDOSULFAN SULFATE	NA	NA	NA	3.6 U	3.7 U	NA
4,4'-DDT	NA	NA	NA	73	110	NA
ENDRIN KETONE	NA	NA	NA	3.6 U	3.7 U	NA
ENDRIN ALDEHYDE	NA	NA	NA	3.6 U	3.7 U	NA
ALPHA-CHLORDANE	NA	NA	NA	1.8 U	1.8 U	NA
GAMMA-CHLORDANE	NA	NA	NA	1.8 U	1.8 U	NA
AROCLOR-1248	NA	NA	NA	NA	NA	4100
AROCLOR-1254	NA	NA	NA	NA	NA	180 U

UG/KG - microgram per kilogram
 J - value is estimated
 U - not detected
 UJ - not detected, value is estimated
 * Data Not Validated

TABLE 4-3
SURFACE SOIL - POSITIVE DETECTION SUMMARY
SITE 36, CAMP GEIGER AREA DUMP
REMEDIAL INVESTIGATION, CTO-0303
MCB, CAMP LEJEUNE, NORTH CAROLINA
TCL ORGANICS

LOCATION	36-OA-SB01K*	36-OF-SB03A*	36-OF-SB03B*	36-OF-SB03C*	36-OF-SB03D*
DATE SAMPLED	05/31/96	05/31/96	05/31/96	05/31/96	05/31/96
DEPTH	0-12"	0-12"	0-12"	0-12"	0-12"
VOLATILES (ug/kg)					
ACETONE	NA	NA	NA	NA	NA
TRICHLOROETHENE	NA	NA	NA	NA	NA
TETRACHLOROETHENE	NA	NA	NA	NA	NA
TOLUENE	NA	NA	NA	NA	NA
STYRENE	NA	NA	NA	NA	NA
XYLENE (TOTAL)	NA	NA	NA	NA	NA
SEMIVOLATILES (ug/kg)					
N-NITROSO-DI-N-PROPYLAMINE	NA	NA	NA	NA	NA
NAPHTHALENE	NA	NA	NA	NA	NA
2-METHYLNAPHTHALENE	NA	NA	NA	NA	NA
ACENAPHTHENE	NA	NA	NA	NA	NA
DIBENZOFURAN	NA	NA	NA	NA	NA
DIETHYLPHTHALATE	NA	NA	NA	NA	NA
FLUORENE	NA	NA	NA	NA	NA
PHENANTHRENE	NA	NA	NA	NA	NA
ANTHRACENE	NA	NA	NA	NA	NA
CARBAZOLE	NA	NA	NA	NA	NA
FLUORANTHENE	NA	NA	NA	NA	NA
PYRENE	NA	NA	NA	NA	NA
BUTYLBENZYLPHTHALATE	NA	NA	NA	NA	NA
BENZO(A)ANTHRACENE	NA	NA	NA	NA	NA
CHRYSENE	NA	NA	NA	NA	NA
BIS(2-ETHYLHEXYL)PHTHALATE	NA	NA	NA	NA	NA
BENZO(B)FLUORANTHENE	NA	NA	NA	NA	NA
BENZO(K)FLUORANTHENE	NA	NA	NA	NA	NA
BENZO(A)PYRENE	NA	NA	NA	NA	NA
INDENO(1,2,3-CD)PYRENE	NA	NA	NA	NA	NA
DIBENZO(A,H)ANTHRACENE	NA	NA	NA	NA	NA
BENZO(G,H,I)PERYLENE	NA	NA	NA	NA	NA

UG/KG - microgram per kilogram

J - value is estimated

U - not detected

UJ - not detected, value is estimated

* Data Not Validated

TABLE 4-3
SURFACE SOIL - POSITIVE DETECTION SUMMARY
SITE 36, CAMP GEIGER AREA DUMP
REMEDIAL INVESTIGATION, CTO-0303
MCB, CAMP LEJEUNE, NORTH CAROLINA
TCL ORGANICS

LOCATION	36-OA-SB01K*	36-OF-SB03A*	36-OF-SB03B*	36-OF-SB03C*	36-OF-SB03D*
DATE SAMPLED	05/31/96	05/31/96	05/31/96	05/31/96	05/31/96
DEPTH	0-12"	0-12"	0-12"	0-12"	0-12"
PESTICIDES/PCBs (ug/kg)					
GAMMA-BHC (LINDANE)	NA	1.8 U	2 U	2 U	1.9 U
HEPTACHLOR	NA	1.8 U	2 U	2 U	1.9 U
ALDRIN	NA	1.8 U	2 U	2 U	1.9 U
HEPTACHLOR EPOXIDE	NA	1.8	2 U	2	1.9
ENDOSULFAN I	NA	1.8 U	2 U	2 U	1.9 U
DIELDRIN	NA	3.6 U	4 U	4 U	3.9 U
4,4'-DDE	NA	27	26	36	80
ENDRIN	NA	3.6 U	4 U	4 U	3.9 U
4,4'-DDD	NA	14	26	28	120
ENDOSULFAN SULFATE	NA	3.6 U	4 U	4 U	3.9 U
4,4'-DDT	NA	12	15	6.8	15
ENDRIN KETONE	NA	3.6 U	4 U	4 U	3.9 U
ENDRIN ALDEHYDE	NA	3.6 U	4 U	4 U	3.9 U
ALPHA-CHLORDANE	NA	1.8 U	4	5.6	5.8
GAMMA-CHLORDANE	NA	1.8 U	2.4	4.4	5.1
AROCLOR-1248	20000	NA	NA	NA	NA
AROCLOR-1254	380 U	NA	NA	NA	NA

UG/KG - microgram per kilogram

J - value is estimated

U - not detected

UJ - not detected, value is estimated

* Data Not Validated

TABLE 4-4
 SURFACE SOIL - POSITIVE DETECTION SUMMARY
 SITE 36, CAMP GEIGER AREA DUMP
 REMEDIAL INVESTIGATION, CTO-0303
 MCB, CAMP LEJEUNE, NORTH CAROLINA
 TAL METALS

LOCATION	36-DAB-SB01-00	36-DAB-SB02-00	36-DAB-SB03-00	36-DAD-SB01-00	36-DAD-SB02-00	36-DAD-SB03-00
DATE SAMPLED	02/24/95	02/24/95	02/24/95	02/24/95	02/24/95	02/24/95
DEPTH	0-12"	0-12"	0-12"	0-12"	0-12"	0-12"
ANALYTES (mg/kg)						
ALUMINUM, TOTAL	2200	5890	3770	5510	3670	3460
ANTIMONY, TOTAL	2.2 UJ	2.4 UJ	4.8 UJ	3.3 J	2.6 UJ	8.4 J
ARSENIC, TOTAL	1.5	0.56	2.3	1.9	1.6	1.9
BARIUM, TOTAL	25.8	21.8	47.3	30.6	42.3	55.1
BERYLLIUM, TOTAL	0.06 U	0.07 U	0.21 U	0.08 U	0.07 U	0.23 U
CADMIUM, TOTAL	0.6 U	0.64 U	1.3 U	2.3	0.69 U	2.8 U
CALCIUM, TOTAL	519	1340	1390	3610	2630	2640
CHROMIUM, TOTAL	5.1 J	7 J	7.7	15 J	7.5 J	10.7
COBALT, TOTAL	0.47 U	0.5 U	1.4	3.1	1	1.6
COPPER, TOTAL	30.3	15.2	99.1	15	38.3	57.8
IRON, TOTAL	7190 J	4190 J	5810	84600 J	5020 J	13100
LEAD, TOTAL	71.3 J	33.4 J	91.9 J	111 J	86.3 J	222 J
MAGNESIUM, TOTAL	121	225	191	1020	299	440
MANGANESE, TOTAL	91.1	32	102	227	77.8	190
MERCURY, TOTAL	1.4 J	0.5 J	1.2	0.16 J	1.7 J	1.7
NICKEL, TOTAL	2.4	2	4.8	10.5	5.6	6.6
POTASSIUM, TOTAL	120	183	206	239	220	191
SELENIUM, TOTAL	0.28 U	0.29 U	0.38 U	0.49 U	0.29 U	0.43 U
SILVER, TOTAL	0.51 U	0.55 U	0.7 U	0.7 U	0.61	0.77 U
SODIUM, TOTAL	27.4	83.3	77.4	358	43.3	55
VANADIUM, TOTAL	5.9	8.7	9.1	43.9	13.8	18.2
ZINC, TOTAL	155	65.8	224	1090	227	303

MG/KG - milligram per kilogram
 J - value is estimated
 R - rejected
 U - not detected
 UJ - not detected, value is estimated

TABLE 4-4
 SURFACE SOIL - POSITIVE DETECTION SUMMARY
 SITE 36, CAMP GEIGER AREA DUMP
 REMEDIAL INVESTIGATION, CTO-0303
 MCB, CAMP LEJEUNE, NORTH CAROLINA
 TAL METALS

LOCATION	36-FCA-SB01-00	36-FCA-SB02-00	36-FCA-SB03-00	36-FCA-SB04-00	36-FCA-SB05-00	36-FCA-SB06-00
DATE SAMPLED	02/27/95	02/22/95	02/23/95	02/25/95	02/27/95	02/23/95
DEPTH	0-12"	0-12"	0-12"	0-12"	0-12"	0-12"
ANALYTES (mg/kg)						
ALUMINUM, TOTAL	5450	6760	7520	2760	12900	13800
ANTIMONY, TOTAL	2.8 R	6.2 UJ	5 UJ	4.8 UJ	2.5 R	2.5 UJ
ARSENIC, TOTAL	0.85 UJ	0.61	0.84	0.45 U	7.7 J	1.3
BARIUM, TOTAL	25	16.4	18.1	5.6	23.2	20
BERYLLIUM, TOTAL	0.08 U	0.27 U	0.22 U	0.21 U	0.16 U	0.07 U
CADMIUM, TOTAL	0.75 U	0.83 U	0.67 U	0.65 U	0.68 U	0.68 U
CALCIUM, TOTAL	8630	2240	595	405	1900	340
CHROMIUM, TOTAL	8.8	10	9.6	4.1	23.1	20.1 J
COBALT, TOTAL	1.1 U	1.1 U	0.72 U	0.7 U	1.1 U	0.54 U
COPPER, TOTAL	3.7 U	1.5 J	1 U	0.44 U	3.2 U	1.4
IRON, TOTAL	3370	7100	5930	2240	16100	14300 J
LEAD, TOTAL	21.7	13.5	14.2	8.6	15.8	12.7
MAGNESIUM, TOTAL	372	320	301	126	637	534
MANGANESE, TOTAL	29.1	5.4	6.6	4.9	13.9	8.1
MERCURY, TOTAL	0.11 U	0.16 U	0.1 U	0.09 U	0.14 U	0.12 UJ
NICKEL, TOTAL	1.9	3.2 U	2.6 U	2.5 U	1.4	1.2
POTASSIUM, TOTAL	270	233	165 U	160 U	676	554
SELENIUM, TOTAL	0.41 J	0.44 U	0.32 U	0.36 U	0.38 J	0.47
SILVER, TOTAL	0.65 U	0.89 UJ	0.72 U	0.7 R	0.58 U	0.58 U
SODIUM, TOTAL	32.2	44.4	36.5	20.6 U	25.2	21.5
VANADIUM, TOTAL	11.1	21.8	19.3	7.9	37.3	32.4
ZINC, TOTAL	31.4	9.3 J	6.9	2.1	9.1	5.4

MG/KG - milligram per kilogram
 J - value is estimated
 R - rejected
 U - not detected
 UJ - not detected, value is estimated

TABLE 4-4
 SURFACE SOIL - POSITIVE DETECTION SUMMARY
 SITE 36, CAMP GEIGER AREA DUMP
 REMEDIAL INVESTIGATION, CTO-0303
 MCB, CAMP LEJEUNE, NORTH CAROLINA
 TAL METALS

LOCATION	36-FCA-SB07-00	36-FCA-SB08-00	36-FCA-SB09-00	36-FCA-SB10-00	36-FCA-SB11-00	36-FCA-SB12-00
DATE SAMPLED	02/22/95	02/27/95	02/22/95	02/22/95	02/23/95	02/22/95
DEPTH	0-12"	0-12"	0-12"	0-12"	0-12"	0-12"
ANALYTES (mg/kg)						
ALUMINUM, TOTAL	1610	4800	17600	2630	9390	2710
ANTIMONY, TOTAL	4 UJ	1.8 R	5.3 UJ	3.8 UJ	2.4 UJ	3.6 UJ
ARSENIC, TOTAL	0.4	2.7 J	7.3	0.55	0.39 U	0.34 U
BARIUM, TOTAL	5.5 U	9.7	24.1	8.9	12.8	10.3
BERYLLIUM, TOTAL	0.17 U	0.06 U	0.23 U	0.18	0.07 U	0.16 U
CADMIUM, TOTAL	0.54 U	0.48 U	0.72 U	0.51 U	0.65 U	0.49 U
CALCIUM, TOTAL	506	691	106	239	150	313
CHROMIUM, TOTAL	2.3	9.2	27.2	4.1	10.1 J	2.5
COBALT, TOTAL	0.58 U	0.5 U	0.77 U	0.71 U	0.51 U	0.52 U
COPPER, TOTAL	0.47 U	0.94 U	2.3 U	4.1 J	0.9 U	1.2 U
IRON, TOTAL	1210	6470	14500	4070	5400 J	1220
LEAD, TOTAL	4.3	9.8 J	10.3	19.2	10.2	11.5 J
MAGNESIUM, TOTAL	84.1	238	750	77.1	260	78.9
MANGANESE, TOTAL	8.8	4.9	7.9	12.1	4.9	7
MERCURY, TOTAL	0.1 U	0.09 U	0.11 U	0.11 U	0.13 UJ	0.11 U
NICKEL, TOTAL	2.1 U	1	2.8 U	2 U	0.94 U	1.9 U
POTASSIUM, TOTAL	132 U	286	527	126 U	289	120 U
SELENIUM, TOTAL	0.3 U	0.26 UJ	0.4 U	0.33 U	0.31 U	0.27 U
SILVER, TOTAL	0.58 U	0.41 U	0.77 U	0.55 UJ	0.56 U	0.52 U
SODIUM, TOTAL	12.9	17.8	40.8	26.8 U	12	9.6
VANADIUM, TOTAL	5.6	16.4	36	7.3	16.3	5.5
ZINC, TOTAL	5.5 U	3.2	6.6	7.4 J	2.7	7.1

MG/KG - milligram per kilogram
 J - value is estimated
 R - rejected
 U - not detected
 UJ - not detected, value is estimated

TABLE 4-4
 SURFACE SOIL - POSITIVE DETECTION SUMMARY
 SITE 36, CAMP GEIGER AREA DUMP
 REMEDIAL INVESTIGATION, CTO-0303
 MCB, CAMP LEJEUNE, NORTH CAROLINA
 TAL METALS

LOCATION	36-FCA-SB13-00	36-FCA-SB14-00	36-FDA-SB01-00	36-FDA-SB02-00	36-FDA-SB03-00	36-FDA-SB04-00
DATE SAMPLED	02/27/95	02/23/95	02/23/95	02/27/95	02/22/95	02/24/95
DEPTH	0-12"	0-12"	0-12"	0-12"	0-12"	0-12"
ANALYTES (mg/kg)						
ALUMINUM, TOTAL	2300	4400	5920	3000	1470	2670
ANTIMONY, TOTAL	4.5 R	3.5 UJ	4.6 UJ	4.5 UJ	2.7 UJ	4.2 UJ
ARSENIC, TOTAL	1.6	1.5	1.1	0.44 U	0.46	0.34 U
BARIUM, TOTAL	5	10	30.9	12.3	9.3	10
BERYLLIUM, TOTAL	0.19 U	0.15 U	0.2 U	0.19 U	0.15 U	0.18 U
CADMIUM, TOTAL	0.6 U	0.48 U	0.95 U	0.6 U	0.71 U	0.56 U
CALCIUM, TOTAL	212 J	168	2630	654	347	416
CHROMIUM, TOTAL	5 J	6.1	9	3.6	3	2.5
COBALT, TOTAL	0.65 U	0.51 U	0.88	0.65 U	0.69 U	0.6 U
COPPER, TOTAL	0.56	1.1 U	27.1	4.2	5	0.84 U
IRON, TOTAL	3210	3520	5300	1740	1210	1390
LEAD, TOTAL	4.7	16	87.1 J	23.7	14.5	8.3
MAGNESIUM, TOTAL	108	146	232	127	52	93.8
MANGANESE, TOTAL	6 J	4.3	67.3	10.6	9	10
MERCURY, TOTAL	0.12 U	0.13 U	0.29	0.13 U	0.1 U	0.11 U
NICKEL, TOTAL	2.3	1.8 U	3.8	2.3 U	1.4	2.2 U
POTASSIUM, TOTAL	148 U	123	153 U	174	64.1 U	138 U
SELENIUM, TOTAL	0.53	0.36 U	0.36 U	0.35 U	0.33 UJ	0.27 U
SILVER, TOTAL	0.65 U	0.51 U	0.67 U	0.65 R	0.61 U	0.6 U
SODIUM, TOTAL	14.3	22.6	30.3 U	22.8 U	14 U	10.8 U
VANADIUM, TOTAL	7.9	13.3	15.4	7.2	4.8	4.7 U
ZINC, TOTAL	3.1	4.7 U	103	17.8	15.8	21.1

MG/KG - milligram per kilogram
 J - value is estimated
 R - rejected
 U - not detected
 UJ - not detected, value is estimated

TABLE 4-4
SURFACE SOIL - POSITIVE DETECTION SUMMARY
SITE 36, CAMP GEIGER AREA DUMP
REMEDIAL INVESTIGATION, CTO-0303
MCB, CAMP LEJEUNE, NORTH CAROLINA
TAL METALS

LOCATION	36-FDA-SB05-00	36-FDA-SB06-00	36-GW07-00	36-GW09-00	36-GW10-00	36-GW11-00
DATE SAMPLED	02/27/95	02/25/95	03/07/95	03/09/95	03/09/95	03/09/95
DEPTH	0-12"	0-12"	0-12"	0-12"	0-12"	0-12"
ANALYTES (mg/kg)						
ALUMINUM, TOTAL	1010	2610	5680	6370	2280	2790
ANTIMONY, TOTAL	2.3 UJ	4.8 J	2.6 UJ	3.1 UJ	2.4 UJ	4.2 UJ
ARSENIC, TOTAL	0.42 U	0.39 U	0.51 J	1.7	0.47	0.56
BARIIUM, TOTAL	4.5	10.7	8.8	17.9	5.3	18.2
BERYLLIUM, TOTAL	0.17 U	0.2 U	0.098 U	0.13 U	0.17 U	0.18 U
CADMIUM, TOTAL	0.61 U	0.62 U	0.68 U	0.84 U	0.65 U	0.56 U
CALCIUM, TOTAL	512	20400	134 J	14800 J	66.1 U	2110
CHROMIUM, TOTAL	1.6	3.9	5.2	13.8	2.3	5.1
COBALT, TOTAL	0.49 U	0.66 U	0.57 U	1.1 U	0.51 U	0.6 U
COPPER, TOTAL	1.6	6.7	0.94 U	12.5	0.89 U	9.9
IRON, TOTAL	863	1660	2960 J	3690 J	1330 J	2050
LEAD, TOTAL	14.5	51.9 J	7.8 U	19.2 U	4.7 U	35.3
MAGNESIUM, TOTAL	56	291	218	275	56.6	114
MANGANESE, TOTAL	14.3	24.2	3	45.8	2.1	25.9
MERCURY, TOTAL	0.1 U	0.1 U	0.11 U	0.16 U	0.088 U	0.11
NICKEL, TOTAL	0.89 U	2.4 U	0.98 U	1.2	0.94 U	2.2 U
POTASSIUM, TOTAL	33.7	152 U	174	279	53.4 U	186
SELENIUM, TOTAL	0.33 U	0.31 U	0.31 U	0.45 U	0.28 U	0.41 U
SILVER, TOTAL	0.53 U	0.66 U	0.59 U	0.72 U	0.56 U	0.6 U
SODIUM, TOTAL	6 U	46.6 U	21.6 U	20.2 U	4.3 U	30.1 U
VANADIUM, TOTAL	2.6 U	5.5	7.8	10.9	4.2	5.5
ZINC, TOTAL	17.2	27.5	2.2	18.8	2.8	45.8

MG/KG - milligram per kilogram
J - value is estimated
R - rejected
U - not detected
UJ - not detected, value is estimated

TABLE 4-4
 SURFACE SOIL - POSITIVE DETECTION SUMMARY
 SITE 36, CAMP GEIGER AREA DUMP
 REMEDIAL INVESTIGATION, CTO-0303
 MCB, CAMP LEJEUNE, NORTH CAROLINA
 TAL METALS

LOCATION	36-OA-SB01-00	36-OA-SB01A-00	36-OA-SB01B-00	36-OA-SB01C-00	36-OA-SB01D-00	36-OA-SB02-00
DATE SAMPLED	02/22/95	03/09/95	03/09/95	03/09/95	03/09/95	02/25/95
DEPTH	0-12"	0-12"	0-12"	0-12"	0-12"	0-12"
ANALYTES (mg/kg)						
ALUMINUM, TOTAL	6950	3840	1560	2830	3910	3560
ANTIMONY, TOTAL	2 UJ	4.7 UJ	4.4 UJ	4.7 UJ	4.4 UJ	4.8 UJ
ARSENIC, TOTAL	2.7	5.1	0.91 J	1.5 J	0.82 J	2.1
BARIUM, TOTAL	19.3	45.2	4.8	12.3	10.8	19.2
BERYLLIUM, TOTAL	0.11 U	0.2 U	0.19 U	0.2 U	0.19 U	0.21 U
CADMIUM, TOTAL	0.87	0.64 U	0.6 U	0.63 U	0.6 U	0.64 U
CALCIUM, TOTAL	35800	979	9070	26500	47400	1700
CHROMIUM, TOTAL	11.3	6.7	4.3	5.4	6.1	4.1
COBALT, TOTAL	0.84 U	0.68 U	0.64 U	0.68 U	0.64 U	0.69 U
COPPER, TOTAL	13.4	5.7	3.2	8.3	5.8	1.8
IRON, TOTAL	4660	4600	1380	2410	2690	4060
LEAD, TOTAL	62.6	28.6	11.7	119	19.5	28.8
MAGNESIUM, TOTAL	675	157	206	502	665	201
MANGANESE, TOTAL	33.7	8.5	7.4	38.6	36.6	68.7
MERCURY, TOTAL	0.09 U	0.09 U	0.09 U	0.09 U	0.1 U	0.13 U
NICKEL, TOTAL	2.8	2.5 U	2.3 U	2.4 U	2.3 U	2.5 U
POTASSIUM, TOTAL	280	156 U	147 U	155 U	146 U	157 U
SELENIUM, TOTAL	0.31 UJ	0.53	0.33 U	0.33 U	0.31 U	0.39
SILVER, TOTAL	0.46 U	0.68 U	0.64 U	0.68 U	0.64 U	0.69 R
SODIUM, TOTAL	120	30.4 U	20	37.8	89.1	19.1 U
VANADIUM, TOTAL	13.4	10	3.8	8.8	8.3	11.8
ZINC, TOTAL	51.3	13.7	15	43	25	74

MG/KG - milligram per kilogram
 J - value is estimated
 R - rejected
 U - not detected
 UJ - not detected, value is estimated

TABLE 4-4
 SURFACE SOIL - POSITIVE DETECTION SUMMARY
 SITE 36, CAMP GEIGER AREA DUMP
 REMEDIAL INVESTIGATION, CTO-0303
 MCB, CAMP LEJEUNE, NORTH CAROLINA
 TAL METALS

LOCATION	36-OA-SB03-00	36-OA-SB04-00	36-OA-SB05-00	36-OA-SB06-00	36-OA-SB07-00	36-OA-SB08-00
DATE SAMPLED	02/25/95	02/24/95	02/28/95	02/27/95	02/24/95	02/27/95
DEPTH	0-12"	0-12"	0-12"	0-12"	0-12"	0-12"
ANALYTES (mg/kg)						
ALUMINUM, TOTAL	4020	6220	5040	3340	3960	7010
ANTIMONY, TOTAL	3.5 UJ	6.3 J	2.8 R	2.5 R	6.3 J	31.7 J
ARSENIC, TOTAL	0.43 U	2.4	1.2 J	0.76 J	4.1	10.4
BARIUM, TOTAL	9.1	73	43.5	31.9	53.8	141
BERYLLIUM, TOTAL	0.15 U	0.21 U	0.18 U	0.07 U	0.19 U	0.25 U
CADMIUM, TOTAL	0.47 U	1.7 U	1.8	0.68 U	3.1 U	6.3
CALCIUM, TOTAL	502	59700	42000	2890	2240	4150
CHROMIUM, TOTAL	4.9	13.3	14.9	5.6	16.6	51.6
COBALT, TOTAL	0.51 U	1.6	1 U	0.75 U	2.7	9
COPPER, TOTAL	0.73	105	69.2	11.1	124	445
IRON, TOTAL	2870	10900	5100	2260	32200	86200
LEAD, TOTAL	7.1	477 J	116	35.6 J	299 J	836 J
MAGNESIUM, TOTAL	153	687	341	164	278	535
MANGANESE, TOTAL	4.9	89.9	49	31.7	267	940
MERCURY, TOTAL	0.11 U	0.84	2.4	0.29	0.3	1.4
NICKEL, TOTAL	1.8 U	6.5	15.8	1.4	8.3	48.3
POTASSIUM, TOTAL	221	157 U	150	136	271	277
SELENIUM, TOTAL	0.34 U	0.45	0.47 J	0.35 UJ	0.33 U	0.39
SILVER, TOTAL	0.51 R	3.8	3.1	0.58 U	0.62 U	0.7
SODIUM, TOTAL	20.2 U	86.7	37.8	12.2	49.2 U	83.5
VANADIUM, TOTAL	7.9	15	14.8	5.3	24.2	46
ZINC, TOTAL	2.3	396	422	52.6	449	1320

MG/KG - milligram per kilogram

J - value is estimated

R - rejected

U - not detected

UJ - not detected, value is estimated

TABLE 4-4
 SURFACE SOIL - POSITIVE DETECTION SUMMARY
 SITE 36, CAMP GEIGER AREA DUMP
 REMEDIAL INVESTIGATION, CTO-0303
 MCB, CAMP LEJEUNE, NORTH CAROLINA
 TAL METALS

LOCATION	36-OF-SB01-00	36-OF-SB02-00	36-OF-SB03-00	36-OF-SB04-00	36-OF-SB05-00	36-OF-SB06-00
DATE SAMPLED	02/21/95	02/21/95	02/21/95	02/22/95	02/21/95	02/21/95
DEPTH	0-12"	0-12"	0-12"	0-12"	0-12"	0-12"
ANALYTES (mg/kg)						
ALUMINUM, TOTAL	2560	6620	3990	5820	3650	8160
ANTIMONY, TOTAL	2.3 UJ	3.4 UJ	7 J	4.6 UJ	3.2 UJ	2.5 UJ
ARSENIC, TOTAL	0.39	1.2	1.9	1.4	0.5	0.92 J
BARIUM, TOTAL	8.8	43.4	20	69.3	21.9	27.1
BERYLLIUM, TOTAL	0.11 U	0.15 U	0.17 U	0.2 U	0.14 U	0.11 U
CADMIUM, TOTAL	0.61 U	0.67	0.53 U	2.1	0.44 U	1.4
CALCIUM, TOTAL	3150	40300	29300	9350	3120	103000
CHROMIUM, TOTAL	1.9	10.6	5.9	21.5	8.9	11.5
COBALT, TOTAL	0.49 U	1 U	0.85 U	2.9 U	1.1 U	0.92
COPPER, TOTAL	1	52.6 J	29 J	105 J	28.9 J	22.1
IRON, TOTAL	1140	5520	5220	6370	13000	5280
LEAD, TOTAL	4.5	69	41	234	43.3	21.7
MAGNESIUM, TOTAL	70.8	321	228	903	133	587
MANGANESE, TOTAL	9.2	40.6	54.9	188	46.1	35.4
MERCURY, TOTAL	0.09 U	0.38	0.12	0.1 U	0.15	0.23
NICKEL, TOTAL	0.89 U	4.7	2.1 U	10.5	6.5	2.5
POTASSIUM, TOTAL	72.4 U	113 U	185	315	107 U	249
SELENIUM, TOTAL	0.28 UJ	0.32	0.28 U	0.3 U	0.29 U	0.35 UJ
SILVER, TOTAL	0.53 U	3 J	0.72 J	12 J	0.47 UJ	2
SODIUM, TOTAL	20 U	40.6	41.7	144	22.9 U	95
VANADIUM, TOTAL	2.9	10.1	6	19	5.2	9.4
ZINC, TOTAL	4.7	276 J	108 J	434 J	53.8 J	58.4

MG/KG - milligram per kilogram

J - value is estimated

R - rejected

U - not detected

UJ - not detected, value is estimated

TABLE 4-4
 SURFACE SOIL - POSITIVE DETECTION SUMMARY
 SITE 36, CAMP GEIGER AREA DUMP
 REMEDIAL INVESTIGATION, CTO-0303
 MCB, CAMP LEJEUNE, NORTH CAROLINA
 TAL METALS

LOCATION	36-OF-SB06A-00	36-OF-SB06B-00	36-OF-SB06C-00	36-OF-SB06D-00
DATE SAMPLED	03/09/95	03/09/95	03/09/95	03/09/95
DEPTH	0-12"	0-12"	0-12"	0-12"
ANALYTES (mg/kg)				
ALUMINUM, TOTAL	4430	7390	4870	4540
ANTIMONY, TOTAL	3.3 UJ	6 UJ	4.9 UJ	6.2 UJ
ARSENIC, TOTAL	1.5	1.6 J	1	0.91
BARIUM, TOTAL	13.7	18.9	26	14.4
BERYLLIUM, TOTAL	0.23 U	0.26 U	0.21 U	0.27 U
CADMIUM, TOTAL	0.87 U	0.81 U	0.86	0.84 U
CALCIUM, TOTAL	10400 J	29800	21800	15600
CHROMIUM, TOTAL	6.1	7.8	7.6	5.2
COBALT, TOTAL	1.1 U	0.87 U	0.88	0.9 U
COPPER, TOTAL	12.6	12.4	19.8	9.8
IRON, TOTAL	3450 J	4920	29700	3010
LEAD, TOTAL	17.9 U	25.1	112	18.1
MAGNESIUM, TOTAL	185	354	251	257
MANGANESE, TOTAL	25.8	47.5	118	43.3
MERCURY, TOTAL	0.13 U	0.16 U	0.2	0.16 U
NICKEL, TOTAL	1.5	3.1 U	3.5	3.2 U
POTASSIUM, TOTAL	184	492	174	319
SELENIUM, TOTAL	0.47	0.62 U	0.33 U	0.53
SILVER, TOTAL	0.75 U	0.87 U	0.71 U	0.9 U
SODIUM, TOTAL	24.3 U	52.7	51.7 U	32.6 U
VANADIUM, TOTAL	9.1	13	6.7	8.4
ZINC, TOTAL	20.2	27.3	79	21.4

MG/KG - milligram per kilogram
 J - value is estimated
 R - rejected
 U - not detected
 UJ - not detected, value is estimated

TABLE 4-5
SUBSURFACE SOIL - POSITIVE DETECTION SUMMARY
SITE 36, CAMP GEIGER AREA DUMP
REMEDIAL INVESTIGATION, CTO-0303
MCB, CAMP LEJEUNE, NORTH CAROLINA
TCL ORGANICS

LOCATION	36-DAB-SB01-01	36-DAB-SB02-02	36-DAB-SB03-01	36-DAD-SB02-01	36-FCA-SB01-04	36-FCA-SB02-04
DATE SAMPLED	02/24/95	02/24/95	02/24/95	02/24/95	02/27/95	02/22/95
DEPTH	1-3'	3-5'	1-3'	1-3'	7-9'	7-9'
VOLATILES (ug/kg)						
ACETONE	100 U	39 U	19 U	14 U	12 U	33 U
1,2-DICHLOROETHENE (TOTAL)	12 U	12 U	11 U	14 U	12 U	12 U
2-BUTANONE	10 J	12 U	11 U	14 U	12 U	12 U
TRICHLOROETHENE	12 U	12 U	11 U	14 U	12 U	12 U
BENZENE	12 U	12 U	11 U	14 U	12 U	12 U
TOLUENE	12 U	12 U	11 U	14 U	12 U	12 U
XYLENE (TOTAL)	12 U	12 U	6 J	14 U	12 U	12 U
SEMIVOLATILES (ug/kg)						
1,4-DICHLOROBENZENE	380 R	97 J	380 U	470 U	410 U	400 U
2-METHYLPHENOL	510 J	380 U	380 U	470 U	410 U	400 U
4-METHYLPHENOL	43 J	380 U	380 U	470 U	410 U	400 U
ISOPHORONE	2100	380 U	380 U	470 U	410 U	400 U
NAPHTHALENE	380 R	380 U	380 U	470 U	410 U	400 U
2-METHYLNAPHTHALENE	380 R	380 U	380 U	470 U	410 U	400 U
PHENANTHRENE	380 R	380 U	380 U	470 U	410 U	400 U
DI-N-BUTYLPHTHALATE	380 U	380 U	380 U	470 U	410 U	400 U
FLUORANTHENE	380 R	380 U	380 U	470 U	410 U	400 U
PYRENE	380 R	380 U	380 U	65 J	410 U	400 U
BUTYLBENZYLPHthalate	380 R	380 U	380 U	470 UJ	410 U	400 U
BENZO(A)ANTHRACENE	380 R	380 U	380 U	470 UJ	410 U	400 U
CHRYSENE	380 R	380 U	380 U	470 UJ	410 U	400 U
BIS(2-ETHYLHEXYL)PHTHALATE	380 U	380 U	380 U	54 J	410 U	400 U
BENZO(B)FLUORANTHENE	380 R	380 U	380 U	470 U	410 U	400 U
BENZO(K)FLUORANTHENE	380 R	380 U	380 U	470 U	410 U	400 U
BENZO(A)PYRENE	380 R	380 U	380 U	470 U	410 U	400 U
INDENO(1,2,3-CD)PYRENE	380 R	380 U	380 U	470 U	410 U	400 U
BENZO(G,H,I)PERYLENE	380 R	380 U	380 U	470 U	410 U	400 U

UG/KG - microgram per kilogram
 J - value is estimated
 NA - not analyzed
 R - rejected
 U - not detected
 UJ - not detected, value is estimated

TABLE 4-5
 SUBSURFACE SOIL - POSITIVE DETECTION SUMMARY
 SITE 36, CAMP GEIGER AREA DUMP
 REMEDIAL INVESTIGATION, CTO-0303
 MCB, CAMP LEJEUNE, NORTH CAROLINA
 TCL ORGANICS

LOCATION	36-DAB-SB01-01	36-DAB-SB02-02	36-DAB-SB03-01	36-DAD-SB02-01	36-FCA-SB01-04	36-FCA-SB02-04
DATE SAMPLED	02/24/95	02/24/95	02/24/95	02/24/95	02/27/95	02/22/95
DEPTH	1-3'	3-5'	1-3'	1-3'	7-9'	7-9'
PESTICIDES/PCBs (ug/kg)						
ALDRIN	3.4 J	13 J	16 J	2.4 U	2 U	2 UJ
HEPTACHLOR EPOXIDE	1.9 UJ	1.9 UJ	1.9 U	2.4 U	2 U	2 UJ
DIELDRIN	18 J	20 J	8.3	4.7 U	4 U	3.3 J
4,4'-DDE	99	82	67 J	66	4 U	4.1 UJ
ENDRIN	3.8 UJ	3.8 UJ	3.8 U	2.4 J	4 U	4.1 UJ
4,4'-DDD	28 J	130	120 J	230	4 U	4.1 UJ
4,4'-DDT	28 J	18 J	16	10 J	4 U	4.1 UJ
ENDRIN ALDEHYDE	3.8 UJ	3.8 UJ	3.8 U	4.7 U	4 U	4.1 UJ
ALPHA-CHLORDANE	1.9 UJ	1.9 UJ	1.9 U	2.4	2 U	2 UJ
GAMMA-CHLORDANE	1.9 UJ	2.3 J	1.9 U	2.4 U	2 U	2 UJ
AROCLOR-1248	38 UJ	38 UJ	38 U	47 U	40 U	41 UJ

UG/KG - microgram per kilogram
 J - value is estimated
 NA - not analyzed
 R - rejected
 U - not detected
 UJ - not detected, value is estimated

TABLE 4-5
SUBSURFACE SOIL - POSITIVE DETECTION SUMMARY
SITE 36, CAMP GEIGER AREA DUMP
REMEDIAL INVESTIGATION, CTO-0303
MCB, CAMP LEJEUNE, NORTH CAROLINA
TCL ORGANICS

LOCATION	36-FCA-SB03-02	36-FCA-SB04-02	36-FCA-SB05-02	36-FCA-SB06-03	36-FCA-SB07-01	36-FCA-SB08-01
DATE SAMPLED	02/23/95	02/25/95	02/27/95	02/23/95	02/22/95	02/27/95
DEPTH	3-5'	3-5'	3-5'	5-7'	1-3'	1-3'
VOLATILES (ug/kg)						
ACETONE	14 U	12 UJ	12 U	12 U	700 B	52
1,2-DICHLOROETHENE (TOTAL)	13 U	12 U	12 U	12 U	14 U	12 U
2-BUTANONE	13 U	12 U	12 U	12 U	14 U	12 U
TRICHLOROETHENE	13 U	12 U	12 U	12 U	14 U	12 U
BENZENE	13 U	12 U	12 U	12 U	14 U	12 U
TOLUENE	13 U	12 U	12 U	12 U	14 U	12 U
XYLENE (TOTAL)	13 U	12 U	12 U	12 U	14 U	12 U
SEMIVOLATILES (ug/kg)						
1,4-DICHLOROBENZENE	430 U	400 U	410 U	410 U	450 U	400 U
2-METHYLPHENOL	430 U	400 U	410 U	410 U	450 U	400 U
4-METHYLPHENOL	430 U	400 U	410 U	410 U	450 U	400 U
ISOPHORONE	430 U	400 U	410 U	410 U	450 U	400 U
NAPHTHALENE	430 U	400 U	410 U	410 U	450 U	400 U
2-METHYLNAPHTHALENE	430 U	400 U	410 U	410 U	450 U	400 U
PHENANTHRENE	430 U	400 U	410 U	410 U	450 U	400 U
DI-N-BUTYLPHTHALATE	430 U	2700 U	590 U	410 U	450 U	400 U
FLUORANTHENE	430 U	400 U	410 U	410 U	450 U	400 U
PYRENE	430 U	400 U	410 UJ	410 U	450 U	400 U
BUTYLBENZYLPHTHALATE	430 U	400 U	410 UJ	410 U	450 U	400 U
BENZO(A)ANTHRACENE	430 U	400 U	410 UJ	410 U	450 U	400 U
CHRYSENE	430 U	400 U	410 UJ	410 U	450 U	400 U
BIS(2-ETHYLHEXYL)PHTHALATE	430 U	400 U	410 UJ	410 U	450 U	400 U
BENZO(B)FLUORANTHENE	430 U	400 U	410 U	410 U	450 U	400 U
BENZO(K)FLUORANTHENE	430 U	400 U	410 U	410 U	450 U	400 U
BENZO(A)PYRENE	430 U	400 U	410 U	410 U	450 U	400 U
INDENO(1,2,3-CD)PYRENE	430 U	400 U	410 U	410 U	450 U	400 U
BENZO(G,H,I)PERYLENE	430 U	400 U	410 U	410 U	450 U	400 U

UG/KG - microgram per kilogram
J - value is estimated
NA - not analyzed
R - rejected
U - not detected
UJ - not detected, value is estimated

TABLE 4-5
 SUBSURFACE SOIL - POSITIVE DETECTION SUMMARY
 SITE 36, CAMP GEIGER AREA DUMP
 REMEDIAL INVESTIGATION, CTO-0303
 MCB, CAMP LEJEUNE, NORTH CAROLINA
 TCL ORGANICS

LOCATION	36-FCA-SB03-02	36-FCA-SB04-02	36-FCA-SB05-02	36-FCA-SB06-03	36-FCA-SB07-01	36-FCA-SB08-01
DATE SAMPLED	02/23/95	02/25/95	02/27/95	02/23/95	02/22/95	02/27/95
DEPTH	3-5'	3-5'	3-5'	5-7'	1-3'	1-3'
PESTICIDES/PCBs (ug/kg)						
ALDRIN	2.2 U	2 U	2 UJ	2 UJ	2.3 U	2 U
HEPTACHLOR EPOXIDE	2.2 U	2 U	2 UJ	2 UJ	2.3 U	2 U
DIELDRIN	4.3 U	3.9 U	4.1 UJ	4.1 UJ	4.5 U	4 U
4,4'-DDE	4.3 UJ	3.9 U	4.1 UJ	4.1 UJ	36 J	4 U
ENDRIN	4.3 U	3.9 U	4.1 UJ	4.1 UJ	4.5 U	4 U
4,4'-DDD	4.3 U	3.9 U	4.1 UJ	4.1 UJ	4.5 U	4 U
4,4'-DDT	4.3 U	3.9 U	4.1 UJ	4.1 UJ	14	4 U
ENDRIN ALDEHYDE	4.3 U	3.9 U	4.1 UJ	4.1 UJ	4.5 U	4 U
ALPHA-CHLORDANE	2.2 U	2 U	2 UJ	2 UJ	2.3 U	2 U
GAMMA-CHLORDANE	2.2 U	2 U	2 UJ	2 UJ	2.3 U	2 U
AROCLOR-1248	43 U	39 U	41 UJ	41 UJ	45 U	40 U

UG/KG - microgram per kilogram
 J - value is estimated
 NA - not analyzed
 R - rejected
 U - not detected
 UJ - not detected, value is estimated

TABLE 4-5
 SUBSURFACE SOIL - POSITIVE DETECTION SUMMARY
 SITE 36, CAMP GEIGER AREA DUMP
 REMEDIAL INVESTIGATION, CTO-0303
 MCB, CAMP LEJEUNE, NORTH CAROLINA
 TCL ORGANICS

LOCATION	36-FCA-SB09-02	36-FCA-SB10-02	36-FCA-SB11-03	36-FCA-SB12-02	36-FCA-SB13-01	36-FCA-SB14-01
DATE SAMPLED	02/22/95	02/22/95	02/23/95	02/22/95	02/27/95	02/23/95
DEPTH	3-5'	3-5'	5-7'	3-5'	1-3'	1-3'
VOLATILES (ug/kg)						
ACETONE	13 U	12 U	12 U	12 U	12 U	11 U
1,2-DICHLOROETHENE (TOTAL)	12 U	12 U	12 U	12 U	12 U	11 U
2-BUTANONE	12 U	12 U	12 U	12 U	12 U	11 U
TRICHLOROETHENE	12 U	12 U	12 U	12 U	12 U	11 U
BENZENE	12 U	12 U	12 U	12 U	12 U	11 U
TOLUENE	12 U	12 U	12 U	12 U	12 U	11 U
XYLENE (TOTAL)	12 U	12 U	12 U	12 U	12 U	11 U
SEMIVOLATILES (ug/kg)						
1,4-DICHLOROBENZENE	390 U	390 U	390 U	380 U	400 U	370 U
2-METHYLPHENOL	390 U	390 U	390 U	380 U	400 U	370 U
4-METHYLPHENOL	390 U	390 U	390 U	380 U	400 U	370 U
ISOPHORONE	390 U	390 U	390 U	380 U	400 U	370 U
NAPHTHALENE	390 U	390 U	390 U	380 U	400 U	370 U
2-METHYLNAPHTHALENE	390 U	390 U	390 U	380 U	400 U	370 U
PHENANTHRENE	390 U	390 U	390 U	380 U	400 U	370 U
DI-N-BUTYLPHTHALATE	390 U	390 U	390 U	380 U	400 U	370 U
FLUORANTHENE	390 U	390 U	390 U	380 U	400 U	370 U
PYRENE	390 U	390 U	390 U	380 U	400 U	370 U
BUTYLBENZYLPHTHALATE	390 U	390 U	390 U	380 U	400 U	370 U
BENZO(A)ANTHRACENE	390 U	390 U	390 U	380 U	400 U	370 U
CHRYSENE	390 U	390 U	390 U	380 U	400 U	370 U
BIS(2-ETHYLHEXYL)PHTHALATE	390 U	390 U	390 U	45 J	400 U	370 U
BENZO(B)FLUORANTHENE	390 U	390 U	390 U	380 U	400 U	370 U
BENZO(K)FLUORANTHENE	390 U	390 U	390 U	380 U	400 U	370 U
BENZO(A)PYRENE	390 U	390 U	390 U	380 U	400 U	370 U
INDENO(1,2,3-CD)PYRENE	390 U	390 U	390 U	380 U	400 U	370 U
BENZO(G,H,I)PERYLENE	390 U	390 U	390 U	380 U	400 U	370 U

UG/KG - microgram per kilogram
 J - value is estimated
 NA - not analyzed
 R - rejected
 U - not detected
 UJ - not detected, value is estimated

TABLE 4-5
SUBSURFACE SOIL - POSITIVE DETECTION SUMMARY
SITE 36, CAMP GEIGER AREA DUMP
REMEDIAL INVESTIGATION, CTO-0303
MCB, CAMP LEJEUNE, NORTH CAROLINA
TCL ORGANICS

LOCATION	36-FCA-SB09-02	36-FCA-SB10-02	36-FCA-SB11-03	36-FCA-SB12-02	36-FCA-SB13-01	36-FCA-SB14-01
DATE SAMPLED	02/22/95	02/22/95	02/23/95	02/22/95	02/27/95	02/23/95
DEPTH	3-5'	3-5'	5-7'	3-5'	1-3'	1-3'
PESTICIDES/PCBs (ug/kg)						
ALDRIN	2 UJ	2 UJ	2 UJ	1.9 U	2 UJ	1.9 U
HEPTACHLOR EPOXIDE	2 UJ	2 UJ	2 UJ	1.9 U	2 UJ	1.9 U
DIELDRIN	4 UJ	9.4 J	3.9 UJ	3.8 U	4.1 UJ	3.8 U
4,4'-DDE	4 UJ	3.9 UJ	3.9 UJ	3.8 UJ	4.1 UJ	3.8 UJ
ENDRIN	4 UJ	3.9 UJ	3.9 UJ	3.8 U	4.1 UJ	3.8 U
4,4'-DDD	4 UJ	3.9 UJ	3.9 UJ	3.8 U	4.1 UJ	3.8 U
4,4'-DDT	4 UJ	3.9 UJ	3.9 UJ	3.8 U	4.1 UJ	3.8 U
ENDRIN ALDEHYDE	4 UJ	3.9 UJ	3.9 UJ	3.8 U	4.1 UJ	3.8 U
ALPHA-CHLORDANE	2 UJ	2 UJ	2 UJ	1.9 U	2 UJ	1.9 U
GAMMA-CHLORDANE	2 UJ	2 UJ	2 UJ	1.9 U	2 UJ	1.9 U
AROCLOR-1248	40 UJ	39 UJ	39 UJ	38 U	41 UJ	38 U

UG/KG - microgram per kilogram
 J - value is estimated
 NA - not analyzed
 R - rejected
 U - not detected
 UJ - not detected, value is estimated

TABLE 4-5
 SUBSURFACE SOIL - POSITIVE DETECTION SUMMARY
 SITE 36, CAMP GEIGER AREA DUMP
 REMEDIAL INVESTIGATION, CTO-0303
 MCB, CAMP LEJEUNE, NORTH CAROLINA
 TCL ORGANICS

LOCATION	36-FDA-SB01-02	36-FDA-SB02-04	36-FDA-SB03-04	36-FDA-SB04-01	36-FDA-SB05-01	36-FDA-SB06-07
DATE SAMPLED	02/23/95	02/27/95	02/22/95	02/24/95	02/27/95	02/25/95
DEPTH	3-5'	7-9'	7-9'	1-3'	1-3'	13-15'
VOLATILES (ug/kg)						
ACETONE	12 U	21 U	12 U	11 U	14 U	160 J
1,2-DICHLOROETHENE (TOTAL)	12 U	12 U	12 U	11 U	14 U	13 U
2-BUTANONE	12 U	12 U	12 U	11 U	14 U	16 J
TRICHLOROETHENE	5 J	12 U	4 J	11 U	14 U	13 U
BENZENE	3 J	12 U	12 U	11 U	14 U	13 U
TOLUENE	12 UJ	12 U	12 U	11 U	14 UJ	13 U
XYLENE (TOTAL)	12 UJ	12 U	12 U	2 J	14 UJ	6 J
SEMIVOLATILES (ug/kg)						
1,4-DICHLOROBENZENE	400 U	400 U	390 U	370 U	440 U	420 U
2-METHYLPHENOL	400 U	400 U	390 U	370 U	440 U	420 U
4-METHYLPHENOL	400 U	400 U	390 U	370 U	440 U	420 U
ISOPHORONE	400 U	400 U	390 U	370 U	440 U	420 U
NAPHTHALENE	400 U	400 U	390 U	370 U	440 U	420 U
2-METHYLNAPHTHALENE	400 U	85 J	390 U	370 U	440 U	420 U
PHENANTHRENE	400 U	400 U	390 U	370 U	440 U	420 U
DI-N-BUTYLPHTHALATE	400 U	400 U	390 U	370 U	440 U	420 U
FLUORANTHENE	400 U	400 U	390 U	370 U	440 U	170 J
PYRENE	400 UJ	59 J	390 U	370 U	440 U	150 J
BUTYLBENZYLPHTHALATE	400 UJ	400 U	390 U	370 U	440 U	420 U
BENZO(A)ANTHRACENE	400 UJ	400 U	390 U	370 U	440 U	110 J
CHRYSENE	400 UJ	41 J	390 U	370 U	440 U	180 J
BIS(2-ETHYLHEXYL)PHTHALATE	400 UJ	400 U	39 J	370 U	440 U	120 J
BENZO(B)FLUORANTHENE	400 U	47 J	390 U	370 U	440 U	130 J
BENZO(K)FLUORANTHENE	400 U	400 U	390 U	370 U	440 U	68 J
BENZO(A)PYRENE	400 U	400 U	390 U	370 U	440 U	77 J
INDENO(1,2,3-CD)PYRENE	400 U	400 U	390 U	370 U	440 U	51 J
BENZO(G,H,I)PERYLENE	400 U	400 U	390 U	370 U	440 U	42 J

UG/KG - microgram per kilogram

J - value is estimated

NA - not analyzed

R - rejected

U - not detected

UJ - not detected, value is estimated

TABLE 4-5
SUBSURFACE SOIL - POSITIVE DETECTION SUMMARY
SITE 36, CAMP GEIGER AREA DUMP
REMEDIAL INVESTIGATION, CTO-0303
MCB, CAMP LEJEUNE, NORTH CAROLINA
TCL ORGANICS

LOCATION	36-FDA-SB01-02	36-FDA-SB02-04	36-FDA-SB03-04	36-FDA-SB04-01	36-FDA-SB05-01	36-FDA-SB06-07
DATE SAMPLED	02/23/95	02/27/95	02/22/95	02/24/95	02/27/95	02/25/95
DEPTH	3-5'	7-9'	7-9'	1-3'	1-3'	13-15'
PESTICIDES/PCBs (ug/kg)						
ALDRIN	2 U	2 U	2 U	1.8 U	2.2 UJ	2.1 U
HEPTACHLOR EPOXIDE	2 U	2 U	2 U	1.8 U	8 J	3.4 J
DIELDRIN	4.1	3.9 U	3.9 U	3.6 U	1200 J	4.2 U
4,4'-DDE	32	250	3.9 UJ	190	1100 J	170 J
ENDRIN	4.1 U	3.9 U	3.9 U	3.6 U	4 J	4.2 U
4,4'-DDD	36	260 J	3.9 U	22 J	1300 J	12
4,4'-DDT	8.6 J	29	3.9 U	340	340	4.6 J
ENDRIN ALDEHYDE	4.1 U	3.9 U	3.9 U	3.6 U	32 J	4.2 U
ALPHA-CHLORDANE	1.6 J	9	2 U	1.8 U	140	3.4 J
GAMMA-CHLORDANE	2.5 J	8.2 J	2 U	1.8 U	100 J	3.4 J
AROCLOR-1248	41 U	39 U	39 U	36 U	45 UJ	42 U

UG/KG - microgram per kilogram
 J - value is estimated
 NA - not analyzed
 R - rejected
 U - not detected
 UJ - not detected, value is estimated

TABLE 4-5
SUBSURFACE SOIL - POSITIVE DETECTION SUMMARY
SITE 36, CAMP GEIGER AREA DUMP
REMEDIAL INVESTIGATION, CTO-0303
MCB, CAMP LEJEUNE, NORTH CAROLINA
TCL ORGANICS

LOCATION	36-GS-SB01-04	36-GS-SB02-04	36-GS-SB03-02	36-GS-SB04-03	36-GS-SB05-01	36-GS-SB05-03
DATE SAMPLED	05/06/95	05/06/95	05/07/95	05/06/95	05/06/95	05/06/95
DEPTH	7-9'	7-9'	3-5'	5-7'	1-3'	5-7'
VOLATILES (ug/kg)						
ACETONE	12 U	12 U	480 J	12 U	23	12 U
1,2-DICHLOROETHENE (TOTAL)	12 U	12 U	25 UJ	12 U	12 U	12 U
2-BUTANONE	12 U	12 U	170 J	12 U	12 U	12 U
TRICHLOROETHENE	12 U	12 U	25 UJ	12 U	12 U	12 U
BENZENE	12 U	12 U	25 UJ	12 U	12 U	12 U
TOLUENE	12 U	12 U	25 UJ	12 U	12 U	12 U
XYLENE (TOTAL)	12 U	12 U	25 UJ	12 U	12 U	12 U
SEMIVOLATILES (ug/kg)						
1,4-DICHLOROBENZENE	410 U	390 U	830 U	410 U	390 U	380 U
2-METHYLPHENOL	410 U	390 U	830 U	410 U	390 U	380 U
4-METHYLPHENOL	410 U	390 U	830 U	410 U	390 U	380 U
ISOPHORONE	410 U	390 U	830 U	410 U	390 U	380 U
NAPHTHALENE	410 U	390 U	830 U	410 U	390 U	380 U
2-METHYLNAPHTHALENE	410 U	390 U	830 U	410 U	390 U	380 U
PHENANTHRENE	410 U	390 U	830 U	410 U	390 U	380 U
DI-N-BUTYLPHTHALATE	700 U	550 U	830 U	410 U	1800 U	2200 U
FLUORANTHENE	410 U	390 U	830 U	410 U	390 U	380 U
PYRENE	410 U	390 U	830 U	410 U	390 U	380 U
BUTYLBENZYLPHTHALATE	410 U	390 U	830 U	410 U	390 U	380 U
BENZO(A)ANTHRACENE	410 U	390 U	830 U	410 U	390 U	380 U
CHRYSENE	410 U	390 U	830 U	410 U	390 U	380 U
BIS(2-ETHYLHEXYL)PHTHALATE	410 U	390 U	830 U	410 U	390 U	380 U
BENZO(B)FLUORANTHENE	410 U	390 U	830 U	410 U	390 U	380 U
BENZO(K)FLUORANTHENE	410 U	390 U	830 U	410 U	390 U	380 U
BENZO(A)PYRENE	410 U	390 U	450 J	410 U	390 U	380 U
INDENO(1,2,3-CD)PYRENE	410 U	390 U	830 U	410 U	390 U	380 U
BENZO(G,H,I)PERYLENE	410 U	390 U	830 U	410 U	390 U	380 U

UG/KG - microgram per kilogram
J - value is estimated
NA - not analyzed
R - rejected
U - not detected
UJ - not detected, value is estimated

TABLE 4-5
SUBSURFACE SOIL - POSITIVE DETECTION SUMMARY
SITE 36, CAMP GEIGER AREA DUMP
REMEDIAL INVESTIGATION, CTO-0303
MCB, CAMP LEJEUNE, NORTH CAROLINA
TCL ORGANICS

LOCATION	36-GS-SB01-04	36-GS-SB02-04	36-GS-SB03-02	36-GS-SB04-03	36-GS-SB05-01	36-GS-SB05-03
DATE SAMPLED	05/06/95	05/06/95	05/07/95	05/06/95	05/06/95	05/06/95
DEPTH	7-9'	7-9'	3-5'	5-7'	1-3'	5-7'
PESTICIDES/PCBs (ug/kg)						
ALDRIN	NA	NA	NA	NA	NA	NA
HEPTACHLOR EPOXIDE	NA	NA	NA	NA	NA	NA
DIELDRIN	NA	NA	NA	NA	NA	NA
4,4'-DDE	NA	NA	NA	NA	NA	NA
ENDRIN	NA	NA	NA	NA	NA	NA
4,4'-DDD	NA	NA	NA	NA	NA	NA
4,4'-DDT	NA	NA	NA	NA	NA	NA
ENDRIN ALDEHYDE	NA	NA	NA	NA	NA	NA
ALPHA-CHLORDANE	NA	NA	NA	NA	NA	NA
GAMMA-CHLORDANE	NA	NA	NA	NA	NA	NA
AROCLOR-1248	NA	NA	NA	NA	NA	NA

UG/KG - microgram per kilogram
 J - value is estimated
 NA - not analyzed
 R - rejected
 U - not detected
 UJ - not detected, value is estimated

TABLE 4-5
SUBSURFACE SOIL - POSITIVE DETECTION SUMMARY
SITE 36, CAMP GEIGER AREA DUMP
REMEDIAL INVESTIGATION, CTO-0303
MCB, CAMP LEJEUNE, NORTH CAROLINA
TCL ORGANICS

LOCATION	36-GS-SB06-02	36-GW07-01	36-GW09-04	36-GW10-03	36-GW12-03	36-GW13-02
DATE SAMPLED	05/07/95	03/07/95	03/09/95	03/09/95	04/23/95	04/24/95
DEPTH	3-5'	1-3'	7-9'	5-7'	5-7'	3-5'
VOLATILES (ug/kg)						
ACETONE	13 U	13 U	40	130	14 U	13 U
1,2-DICHLOROETHENE (TOTAL)	13 U	13 U	11 U	14 U	14 U	13 U
2-BUTANONE	13 U	13 U	11 U	14 U	14 U	13 U
TRICHLOROETHENE	13 U	13 U	11 U	14 U	14 U	13 U
BENZENE	13 U	13 U	11 U	14 U	14 U	13 U
TOLUENE	13 U	13 U	11 U	14 U	14 U	13 U
XYLENE (TOTAL)	13 U	13 U	3 J	14 U	14 U	13 U
SEMIVOLATILES (ug/kg)						
1,4-DICHLOROBENZENE	430 U	410 U	370 U	460 U	NA	NA
2-METHYLPHENOL	430 U	410 U	370 U	460 U	NA	NA
4-METHYLPHENOL	430 U	410 U	370 U	460 U	NA	NA
ISOPHORONE	430 U	410 U	370 U	460 U	NA	NA
NAPHTHALENE	430 U	410 U	370 U	460 U	NA	NA
2-METHYLNAPHTHALENE	430 U	410 U	370 U	460 U	NA	NA
PHENANTHRENE	430 U	410 U	370 U	460 U	NA	NA
DI-N-BUTYLPHTHALATE	430 U	410 U	370 U	2700 U	NA	NA
FLUORANTHENE	430 U	410 U	370 U	460 U	NA	NA
PYRENE	430 U	410 U	370 U	460 U	NA	NA
BUTYLBENZYLPHTHALATE	430 U	410 U	370 U	460 U	NA	NA
BENZO(A)ANTHRACENE	430 U	410 U	370 U	460 U	NA	NA
CHRYSENE	430 U	410 U	370 U	460 U	NA	NA
BIS(2-ETHYLHEXYL)PHTHALATE	430 U	530	370 U	460 U	NA	NA
BENZO(B)FLUORANTHENE	430 U	410 U	370 U	460 U	NA	NA
BENZO(K)FLUORANTHENE	430 U	410 U	370 U	460 U	NA	NA
BENZO(A)PYRENE	430 U	410 U	370 U	460 U	NA	NA
INDENO(1,2,3-CD)PYRENE	430 U	410 U	370 U	460 U	NA	NA
BENZO(G,H,I)PERYLENE	430 U	410 U	370 U	460 U	NA	NA

UG/KG - microgram per kilogram
J - value is estimated
NA - not analyzed
R - rejected
U - not detected
UJ - not detected, value is estimated

TABLE 4-5
SUBSURFACE SOIL - POSITIVE DETECTION SUMMARY
SITE 36, CAMP GEIGER AREA DUMP
REMEDIAL INVESTIGATION, CTO-0303
MCB, CAMP LEJEUNE, NORTH CAROLINA
TCL ORGANICS

LOCATION	36-GS-SB06-02	36-GW07-01	36-GW09-04	36-GW10-03	36-GW12-03	36-GW13-02
DATE SAMPLED	05/07/95	03/07/95	03/09/95	03/09/95	04/23/95	04/24/95
DEPTH	3-5'	1-3'	7-9'	5-7'	5-7'	3-5'
PESTICIDES/PCBs (ug/kg)						
ALDRIN	NA	2 UJ	1.9 U	2.3 UJ	NA	NA
HEPTACHLOR EPOXIDE	NA	2 UJ	1.9 U	2.3 UJ	NA	NA
DIELDRIN	NA	4.1 UJ	3.7 U	4.5 UJ	NA	NA
4,4'-DDE	NA	4.1 UJ	6.7	4.5 UJ	NA	NA
ENDRIN	NA	4.1 UJ	3.7 U	4.5 UJ	NA	NA
4,4'-DDD	NA	4.1 UJ	7.9	6.8 J	NA	NA
4,4'-DDT	NA	4.1 UJ	3.7 U	4.5 UJ	NA	NA
ENDRIN ALDEHYDE	NA	4.1 UJ	3.7 U	4.5 UJ	NA	NA
ALPHA-CHLORDANE	NA	2 UJ	1.9 U	2.3 UJ	NA	NA
GAMMA-CHLORDANE	NA	2 UJ	1.9 U	2.3 UJ	NA	NA
AROCLOR-1248	NA	41 UJ	37 U	45 UJ	NA	NA

UG/KG - microgram per kilogram
 J - value is estimated
 NA - not analyzed
 R - rejected
 U - not detected
 UJ - not detected, value is estimated

TABLE 4-5
SUBSURFACE SOIL - POSITIVE DETECTION SUMMARY
SITE 36, CAMP GEIGER AREA DUMP
REMEDIAL INVESTIGATION, CTO-0303
MCB, CAMP LEJEUNE, NORTH CAROLINA
TCL ORGANICS

LOCATION	36-GW13-03	36-GW14-02	36-OA-SB01-01	36-OA-SB01A-01	36-OA-SB01B-01	36-OA-SB01C-01
DATE SAMPLED	04/24/95	04/24/95	02/22/95	03/09/95	03/09/95	03/09/95
DEPTH	5-7'	3-5'	1-3'	1-3'	1-3'	1-3'
VOLATILES (ug/kg)						
ACETONE	12 U	12 U	12 U	12 U	11 U	11 U
1,2-DICHLOROETHENE (TOTAL)	12 U	12 U	4 J	12 U	11 U	11 U
2-BUTANONE	12 U	12 U	12 U	12 U	11 U	11 U
TRICHLOROETHENE	12 U	12 U	3 J	12 U	11 U	11 U
BENZENE	12 U	12 U	12 U	12 U	11 U	11 U
TOLUENE	12 U	12 U	12 U	12 UJ	11 U	11 U
XYLENE (TOTAL)	12 U	12 U	3 J	12 UJ	11 U	11 U
SEMIVOLATILES (ug/kg)						
1,4-DICHLOROBENZENE	NA	NA	380 U	400 U	380 U	370 U
2-METHYLPHENOL	NA	NA	380 U	400 U	380 U	370 U
4-METHYLPHENOL	NA	NA	380 U	400 U	380 U	370 U
ISOPHORONE	NA	NA	380 U	400 U	380 U	370 U
NAPHTHALENE	NA	NA	380 U	41 J	380 U	370 U
2-METHYLNAPHTHALENE	NA	NA	380 U	65 J	380 U	370 U
PHENANTHRENE	NA	NA	380 U	95 J	380 U	370 U
DI-N-BUTYLPHTHALATE	NA	NA	56 J	400 U	380 U	370 U
FLUORANTHENE	NA	NA	380 U	400 U	380 U	370 U
PYRENE	NA	NA	380 U	400 U	380 U	370 U
BUTYLBENZYLPHTHALATE	NA	NA	380 U	400 U	380 U	370 U
BENZO(A)ANTHRACENE	NA	NA	380 U	400 U	380 U	370 U
CHRYSENE	NA	NA	380 U	55 J	380 U	370 U
BIS(2-ETHYLHEXYL)PHTHALATE	NA	NA	48 J	630 U	380 U	370 U
BENZO(B)FLUORANTHENE	NA	NA	380 U	400 U	380 U	370 U
BENZO(K)FLUORANTHENE	NA	NA	380 U	400 U	380 U	370 U
BENZO(A)PYRENE	NA	NA	380 U	400 U	380 U	370 U
INDENO(1,2,3-CD)PYRENE	NA	NA	380 U	400 U	380 U	370 U
BENZO(G,H,I)PERYLENE	NA	NA	380 U	400 U	380 U	370 U

UG/KG - microgram per kilogram

J - value is estimated

NA - not analyzed

R - rejected

U - not detected

UJ - not detected, value is estimated

TABLE 4-5
SUBSURFACE SOIL - POSITIVE DETECTION SUMMARY
SITE 36, CAMP GEIGER AREA DUMP
REMEDIAL INVESTIGATION, CTO-0303
MCB, CAMP LEJEUNE, NORTH CAROLINA
TCL ORGANICS

LOCATION	36-GW13-03	36-GW14-02	36-OA-SB01-01	36-OA-SB01A-01	36-OA-SB01B-01	36-OA-SB01C-01
DATE SAMPLED	04/24/95	04/24/95	02/22/95	03/09/95	03/09/95	03/09/95
DEPTH	5-7'	3-5'	1-3'	1-3'	1-3'	1-3'
PESTICIDES/PCBs (ug/kg)						
ALDRIN	NA	NA	1.9 U	20 U	1.9 U	1.9 U
HEPTACHLOR EPOXIDE	NA	NA	1.9 U	20 U	1.9 U	1.9 U
DIELDRIN	NA	NA	3.5 J	50	12	3.8 U
4,4'-DDE	NA	NA	38 J	1700	81	21
ENDRIN	NA	NA	3.9 U	40 U	3.8 U	3.8 U
4,4'-DDD	NA	NA	8.9 J	210 J	27	13
4,4'-DDT	NA	NA	18 J	3100	51 J	8.7
ENDRIN ALDEHYDE	NA	NA	3.9 U	40 U	3.8 U	3.8 U
ALPHA-CHLORDANE	NA	NA	1.9 U	20 U	1.9 U	1.9 U
GAMMA-CHLORDANE	NA	NA	1.9 U	20 U	1.9 U	1.9 U
AROCLOR-1248	NA	NA	850 J	400 U	38 U	38 U

UG/KG - microgram per kilogram
 J - value is estimated
 NA - not analyzed
 R - rejected
 U - not detected
 UJ - not detected, value is estimated

TABLE 4-5
SUBSURFACE SOIL - POSITIVE DETECTION SUMMARY
SITE 36, CAMP GEIGER AREA DUMP
REMEDIAL INVESTIGATION, CTO-0303
MCB, CAMP LEJEUNE, NORTH CAROLINA
TCL ORGANICS

LOCATION	36-OA-SB01D-01	36-OA-SB02-03	36-OA-SB03-03	36-OA-SB04-02	36-OA-SB05-02	36-OA-SB06-02
DATE SAMPLED	03/09/95	02/25/95	02/25/95	02/24/95	02/28/95	02/27/95
DEPTH	1-3'	5-7'	5-7'	3-5'	3-5'	3-5'
VOLATILES (ug/kg)						
ACETONE	11 U	12 U	12 UJ	12 U	12	12 U
1,2-DICHLOROETHENE (TOTAL)	11 U	12 U	12 U	12 U	12 U	12 U
2-BUTANONE	11 U	12 U	12 U	12 U	12 U	12 U
TRICHLOROETHENE	11 U	12 U	12 U	12 U	12 U	12 U
BENZENE	11 U	12 U	12 U	12 U	12 U	12 U
TOLUENE	11 U	12 U	12 U	12 U	12 U	12 UJ
XYLENE (TOTAL)	11 U	12 U	12 U	12 U	12 U	5 J
SEMIVOLATILES (ug/kg)						
1,4-DICHLOROBENZENE	380 U	390 U	390 U	390 U	400 U	380 U
2-METHYLPHENOL	380 U	390 U	390 U	390 U	400 U	380 U
4-METHYLPHENOL	380 U	390 U	390 U	390 U	400 U	380 U
ISOPHORONE	380 U	390 U	390 U	390 U	400 U	380 U
NAPHTHALENE	380 U	390 U	390 U	390 U	400 U	380 U
2-METHYLNAPHTHALENE	380 U	390 U	390 U	390 U	400 U	380 U
PHENANTHRENE	380 U	390 U	390 U	390 U	400 U	380 U
DI-N-BUTYLPHTHALATE	380 U	1600 U	2400 U	390 U	400 U	380 U
FLUORANTHENE	380 U	390 U	390 U	390 U	400 U	380 U
PYRENE	380 U	390 U	390 U	390 U	400 UJ	380 U
BUTYLBENZYLPHTHALATE	380 U	390 U	170 J	390 U	400 UJ	380 U
BENZO(A)ANTHRACENE	380 U	390 U	390 U	390 U	400 UJ	380 U
CHRYSENE	380 U	390 U	390 U	390 U	400 UJ	380 U
BIS(2-ETHYLHEXYL)PHTHALATE	380 U	390 U	390 U	390 U	350 J	380 U
BENZO(B)FLUORANTHENE	380 U	390 U	390 U	390 U	400 U	380 U
BENZO(K)FLUORANTHENE	380 U	390 U	390 U	390 U	400 U	380 U
BENZO(A)PYRENE	380 U	390 U	390 U	390 U	400 U	380 U
INDENO(1,2,3-CD)PYRENE	380 U	390 U	390 U	390 U	400 U	380 U
BENZO(G,H,I)PERYLENE	380 U	390 U	390 U	390 U	400 U	380 U

UG/KG - microgram per kilogram
 J - value is estimated
 NA - not analyzed
 R - rejected
 U - not detected
 UJ - not detected, value is estimated

TABLE 4-5
SUBSURFACE SOIL - POSITIVE DETECTION SUMMARY
SITE 36, CAMP GEIGER AREA DUMP
REMEDIAL INVESTIGATION, CTO-0303
MCB, CAMP LEJEUNE, NORTH CAROLINA
TCL ORGANICS

LOCATION	36-OA-SB01D-01	36-OA-SB02-03	36-OA-SB03-03	36-OA-SB04-02	36-OA-SB05-02	36-OA-SB06-02
DATE SAMPLED	03/09/95	02/25/95	02/25/95	02/24/95	02/28/95	02/27/95
DEPTH	1-3'	5-7'	5-7'	3-5'	3-5'	3-5'
PESTICIDES/PCBs (ug/kg)						
ALDRIN	1.9 U	2 U	1.9 U	1.9 U	2 U	1.9 UJ
HEPTACHLOR EPOXIDE	1.9 U	2 U	1.9 U	1.9 U	2 U	1.9 UJ
DIELDRIN	3.8 U	3.9 U	3.8 U	3.9 U	4 U	3.7 UJ
4,4'-DDE	92	3.9 U	200	3.9 U	4 U	3.7 UJ
ENDRIN	3.8 U	3.9 U	3.8 U	3.9 U	4 U	3.7 UJ
4,4'-DDD	47 J	3.9 U	430 J	3.9 U	4 U	3.7 UJ
4,4'-DDT	30	3.9 U	220	3.9 U	4 U	3.7 UJ
ENDRIN ALDEHYDE	3.8 U	3.9 U	3.8 U	3.9 U	4 U	3.7 UJ
ALPHA-CHLORDANE	4.5	2 U	1.9 U	1.9 U	2 U	1.9 UJ
GAMMA-CHLORDANE	1.9 U	2 U	1.9 U	1.9 U	2 U	1.9 UJ
AROCLOR-1248	420	39 U	38 U	39 U	40 U	37 UJ

UG/KG - microgram per kilogram
 J - value is estimated
 NA - not analyzed
 R - rejected
 U - not detected
 UJ - not detected, value is estimated

TABLE 4-5
 SUBSURFACE SOIL - POSITIVE DETECTION SUMMARY
 SITE 36, CAMP GEIGER AREA DUMP
 REMEDIAL INVESTIGATION, CTO-0303
 MCB, CAMP LEJEUNE, NORTH CAROLINA
 TCL ORGANICS

LOCATION	36-OA-SB07-01	36-OA-SB08-01	36-OF-SB01-04	36-OF-SB02-02	36-OF-SB03-03	36-OF-SB04-04
DATE SAMPLED	02/24/95	02/27/95	02/21/95	02/21/95	02/21/95	02/22/95
DEPTH	1-3'	1-3'	7-9'	3-5'	5-7'	7-9'
VOLATILES (ug/kg)						
ACETONE	12 U	12 U	12 U	12 U	12 U	120 U
1,2-DICHLOROETHENE (TOTAL)	12 U	12 U	12 U	12 U	12 U	13 U
2-BUTANONE	12 U	12 U	12 U	12 U	12 U	13 U
TRICHLOROETHENE	12 UJ	12 U	12 UJ	12 U	12 U	13 U
BENZENE	12 UJ	12 U	12 U	12 U	12 U	13 U
TOLUENE	12 UJ	12 U	10 J	5 J	13	13 U
XYLENE (TOTAL)	4 J	12 U	12 U	12 U	12 U	13 U
SEMIVOLATILES (ug/kg)						
1,4-DICHLOROBENZENE	410 U	390 U	400 U	380 U	380 U	430 U
2-METHYLPHENOL	410 U	390 U	400 U	380 U	380 U	430 U
4-METHYLPHENOL	410 U	390 U	400 U	380 U	380 U	430 U
ISOPHORONE	410 U	390 U	400 U	380 U	380 U	430 U
NAPHTHALENE	410 U	390 U	400 U	380 U	380 U	430 U
2-METHYLNAPHTHALENE	410 U	390 U	400 U	380 U	380 U	430 U
PHENANTHRENE	190 J	390 U	400 U	380 U	380 U	430 U
DI-N-BUTYLPHTHALATE	410 U	390 U	400 U	380 U	2300 U	430 U
FLUORANTHENE	320 J	390 U	400 U	380 U	380 U	430 U
PYRENE	320 J	390 U	400 U	380 U	380 U	430 U
BUTYLBENZYLPHTHALATE	410 UJ	390 U	42 J	380 U	110 J	430 U
BENZO(A)ANTHRACENE	140 J	390 U	400 U	380 U	380 U	430 U
CHRYSENE	200 J	390 U	400 U	380 U	380 U	430 U
BIS(2-ETHYLHEXYL)PHTHALATE	140 J	390 U	63 J	380 U	380 U	76 J
BENZO(B)FLUORANTHENE	170 J	390 U	400 U	380 U	380 U	44 J
BENZO(K)FLUORANTHENE	68 J	390 U	400 U	380 U	380 U	430 U
BENZO(A)PYRENE	83 J	390 U	400 U	380 U	380 U	430 U
INDENO(1,2,3-CD)PYRENE	110 J	390 U	400 U	380 U	380 U	430 U
BENZO(G,H,I)PERYLENE	89 J	390 U	400 U	380 U	380 U	430 U

UG/KG - microgram per kilogram
 J - value is estimated
 NA - not analyzed
 R - rejected
 U - not detected
 UJ - not detected, value is estimated

TABLE 4-5
 SUBSURFACE SOIL - POSITIVE DETECTION SUMMARY
 SITE 36, CAMP GEIGER AREA DUMP
 REMEDIAL INVESTIGATION, CTO-0303
 MCB, CAMP LEJEUNE, NORTH CAROLINA
 TCL ORGANICS

LOCATION	36-OA-SB07-01	36-OA-SB08-01	36-OF-SB01-04	36-OF-SB02-02	36-OF-SB03-03	36-OF-SB04-04
DATE SAMPLED	02/24/95	02/27/95	02/21/95	02/21/95	02/21/95	02/22/95
DEPTH	1-3'	1-3'	7-9'	3-5'	5-7'	7-9'
PESTICIDES/PCBs (ug/kg)						
ALDRIN	2 U	2 UJ	2 U	1.9 UJ	1.5 J	2.2 UJ
HEPTACHLOR EPOXIDE	2 U	2 UJ	2 U	1.9 UJ	1.9 UJ	2.2 UJ
DIELDRIN	4.1 U	4 UJ	4 U	12 J	22 J	2.2 J
4,4'-DDE	450 J	35 J	4 UJ	3.7 UJ	3.7 UJ	3.9 J
ENDRIN	4.1 J	4 UJ	4 U	3.7 UJ	3.7 UJ	4.3 UJ
4,4'-DDD	430 J	15 J	4 U	3.7 UJ	3.7 UJ	3 J
4,4'-DDT	56	18 J	4 U	3.7 UJ	3.7 UJ	3 J
ENDRIN ALDEHYDE	4.1 U	4 UJ	4 U	3.7 UJ	3.7 UJ	4.3 UJ
ALPHA-CHLORDANE	4.1 J	20 J	2 U	1.9 UJ	1.9 UJ	2.2 UJ
GAMMA-CHLORDANE	5.7 J	17 J	2 U	1.9 UJ	1.9 UJ	2.2 UJ
AROCLOR-1248	41 U	40 UJ	40 U	37 UJ	37 UJ	43 UJ

UG/KG - microgram per kilogram
 J - value is estimated
 NA - not analyzed
 R - rejected
 U - not detected
 UJ - not detected, value is estimated

TABLE 4-5
SUBSURFACE SOIL - POSITIVE DETECTION SUMMARY
SITE 36, CAMP GEIGER AREA DUMP
REMEDIAL INVESTIGATION, CTO-0303
MCB, CAMP LEJEUNE, NORTH CAROLINA
TCL ORGANICS

LOCATION	36-OF-SB05-06	36-OF-SB06-03	36-OF-SB06A-01	36-OF-SB06B-02	36-OF-SB06C-02	36-OF-SB06D-02
DATE SAMPLED	02/21/95	02/21/95	03/09/95	03/09/95	03/09/95	03/09/95
DEPTH	11-13'	5-7'	1-3'	3-5'	3-5'	3-5'
VOLATILES (ug/kg)						
ACETONE	24	14 U	12 U	13 U	12 U	12 U
1,2-DICHLOROETHENE (TOTAL)	12 U	13 U	12 U	13 U	12 U	12 U
2-BUTANONE	12 U	13 U	12 U	13 U	12 U	12 U
TRICHLOROETHENE	12 U	13 UJ	12 U	13 U	12 U	12 U
BENZENE	12 U	13 U	12 U	13 U	12 U	12 U
TOLUENE	14	17	12 UJ	13 U	12 U	12 U
XYLENE (TOTAL)	12 U	13 U	4 J	13 U	12 U	12 U
SEMIVOLATILES (ug/kg)						
1,4-DICHLOROBENZENE	390 U	430 U	390 U	410 U	390 U	410 U
2-METHYLPHENOL	390 U	430 U	390 U	410 U	390 U	410 U
4-METHYLPHENOL	390 U	430 U	390 U	410 U	390 U	410 U
ISOPHORONE	390 U	430 U	390 U	410 U	390 U	410 U
NAPHTHALENE	390 U	430 U	390 U	410 U	390 U	410 U
2-METHYLNAPHTHALENE	390 U	430 U	390 U	410 U	390 U	410 U
PHENANTHRENE	390 U	430 U	390 U	410 U	390 U	48 J
DI-N-BUTYLPHTHALATE	1900 U	430 U	390 U	1400 U	1000 U	1000 U
FLUORANTHENE	390 U	430 U	390 U	410 U	390 U	130 J
PYRENE	390 U	430 U	390 U	410 U	390 U	120 J
BUTYLBENZYLPHTHALATE	390 U	430 U	390 U	410 U	390 U	410 U
BENZO(A)ANTHRACENE	390 U	430 U	390 U	410 U	390 U	69 J
CHRYSENE	390 U	430 U	390 U	410 U	390 U	110 J
BIS(2-ETHYLHEXYL)PHTHALATE	120 J	97 J	200 J	410 U	390 U	410 U
BENZO(B)FLUORANTHENE	390 U	430 U	390 U	410 U	390 U	110 J
BENZO(K)FLUORANTHENE	390 U	430 U	390 U	410 U	390 U	42 J
BENZO(A)PYRENE	390 U	430 U	390 U	410 U	390 U	72 J
INDENO(1,2,3-CD)PYRENE	390 U	430 U	390 U	410 U	390 U	48 J
BENZO(G,H,I)PERYLENE	390 U	430 U	390 U	410 U	390 U	410 U

UG/KG - microgram per kilogram
J - value is estimated
NA - not analyzed
R - rejected
U - not detected
UJ - not detected, value is estimated

TABLE 4-5
SUBSURFACE SOIL - POSITIVE DETECTION SUMMARY
SITE 36, CAMP GEIGER AREA DUMP
REMEDIAL INVESTIGATION, CTO-0303
MCB, CAMP LEJEUNE, NORTH CAROLINA
TCL ORGANICS

LOCATION	36-OF-SB05-06	36-OF-SB06-03	36-OF-SB06A-01	36-OF-SB06B-02	36-OF-SB06C-02	36-OF-SB06D-02
DATE SAMPLED	02/21/95	02/21/95	03/09/95	03/09/95	03/09/95	03/09/95
DEPTH	11-13'	5-7'	1-3'	3-5'	3-5'	3-5'
PESTICIDES/PCBs (ug/kg)						
ALDRIN	1.9 UJ	2.2 U	1.9 UJ	2.1 UJ	1.9 UJ	2 U
HEPTACHLOR EPOXIDE	1.9 UJ	2.2 U	1.9 UJ	2.1 UJ	1.9 UJ	2 U
DIELDRIN	3.8 UJ	4.4 U	16 J	4.5 J	3.1 J	11
4,4'-DDE	2.3 J	12 J	230 J	650 J	14 J	220 J
ENDRIN	3.8 UJ	4.4 U	3.1 J	5 J	3.9 UJ	4 U
4,4'-DDD	2.3 J	28	180	190	41 J	110
4,4'-DDT	3.8 UJ	4.4 J	18 J	8.3 J	21 J	82
ENDRIN ALDEHYDE	3.8 UJ	4.4 U	3.5 J	4.1 J	3.9 UJ	4 U
ALPHA-CHLORDANE	1.9 UJ	2.2 U	5.1 J	1.7 J	1.9 UJ	1.6 J
GAMMA-CHLORDANE	1.9 UJ	2.2 U	3.1 J	2.1 UJ	1.9 UJ	2 U
AROCLOR-1248	38 UJ	44 U	39 UJ	41 UJ	39 UJ	40 U

UG/KG - microgram per kilogram
 J - value is estimated
 NA - not analyzed
 R - rejected
 U - not detected
 UJ - not detected, value is estimated

TABLE 4-6
 SUBSURFACE SOIL - POSITIVE DETECTION SUMMARY
 SITE 36, CAMP GEIGER AREA DUMP
 REMEDIAL INVESTIGATION, CTO-0303
 MCB, CAMP LEJEUNE, NORTH CAROLINA
 TAL METALS

LOCATION	36-DAB-SB01-01	36-DAB-SB02-02	36-DAB-SB03-01	36-DAD-SB02-01	36-FCA-SB01-04	36-FCA-SB02-04
DATE SAMPLED	02/24/95	02/24/95	02/24/95	02/24/95	02/27/95	02/22/95
DEPTH	1-3'	3-5'	1-3'	1-3'	7-9'	7-9'
ANALYTES (mg/kg)						
ALUMINUM, TOTAL	3640	3610	4740	5440	8410	5280
ANTIMONY, TOTAL	1.8 UJ	2.5 UJ	3.7 UJ	4.9 UJ	2.4 R	4.1 UJ
ARSENIC, TOTAL	0.99	1.1	0.67	0.96	0.45 J	0.75
BARIUM, TOTAL	58.5	39.5	32.3	28.4	11	9
BERYLLIUM, TOTAL	0.05 U	0.07 U	0.16 U	0.21 U	0.07 U	0.18 U
CADMIUM, TOTAL	0.47 U	0.66	0.81 U	0.7 U	0.64 U	0.56 U
CALCIUM, TOTAL	768	2830	657	2250	30.9 U	81.8
CHROMIUM, TOTAL	13.2 J	8.6 J	5.6	10	8.1	4.4
COBALT, TOTAL	0.57	0.86	0.66	0.71 U	0.62 U	0.96 U
COPPER, TOTAL	37.2	19.9	12.1	12.4	0.89 U	0.38 UJ
IRON, TOTAL	4070 J	7090 J	3240	3500	3460	2840
LEAD, TOTAL	158 J	82.8 J	37.6 J	60.1 J	8.4	5 J
MAGNESIUM, TOTAL	165	212	186	353	301	142
MANGANESE, TOTAL	67.2	76.1	36.9	27.8	4.2	1.7
MERCURY, TOTAL	1.7 J	1.4 J	0.54	1.9	0.37	0.11 U
NICKEL, TOTAL	4.4	55.1	6.9	72.1	1.1	2.8
POTASSIUM, TOTAL	153	142	132	199	165	136 U
SELENIUM, TOTAL	0.31 U	0.27 U	0.26 U	0.35 U	0.27 UJ	0.34 U
SILVER, TOTAL	0.41 U	0.56 U	0.54 U	0.71 U	0.55	0.6 UJ
SODIUM, TOTAL	243	150	132	129	35.6	35
VANADIUM, TOTAL	6.5	6.4	6.4	9.7	9.4	8
ZINC, TOTAL	206	361	112	98.2	1.8 U	1.9

UG/KG - microgram per kilogram

J - value is estimated

R - rejected

U - not detected

UJ - not detected, value is estimated

TABLE 4-6
 SUBSURFACE SOIL - POSITIVE DETECTION SUMMARY
 SITE 36, CAMP GEIGER AREA DUMP
 REMEDIAL INVESTIGATION, CTO-0303
 MCB, CAMP LEJEUNE, NORTH CAROLINA
 TAL METALS

LOCATION	36-FCA-SB03-02	36-FCA-SB04-02	36-FCA-SB05-02	36-FCA-SB06-03	36-FCA-SB07-01	36-FCA-SB08-01
DATE SAMPLED	02/23/95	02/25/95	02/27/95	02/23/95	02/22/95	02/27/95
DEPTH	3-5'	3-5'	3-5'	5-7'	1-3'	1-3'
ANALYTES (mg/kg)						
ALUMINUM, TOTAL	9910	6370	7490	8330	10200	2980
ANTIMONY, TOTAL	4.7 UJ	4.9 UJ	1.8 R	2.6 UJ	5.1 UJ	1.8 R
ARSENIC, TOTAL	1.9	0.45 U	0.46 UJ	0.41 U	5	0.36 J
BARIUM, TOTAL	17.9	8.2	11.1	14.3	19.6	5.9
BERYLLIUM, TOTAL	0.2 U	0.21 U	0.05 U	0.07 U	0.22 U	0.05 U
CADMIUM, TOTAL	0.64 U	0.66 U	0.48 U	0.68 U	0.69 U	0.48 U
CALCIUM, TOTAL	105	51.4	27.7	238	196	49.7
CHROMIUM, TOTAL	14.9	4.7	7	6.1 J	19.6	3.1
COBALT, TOTAL	0.68 U	0.71 U	0.57 U	0.54 U	0.74 U	0.41 U
COPPER, TOTAL	2 U	0.45 U	0.67 U	0.94 U	2.2 U	0.9 U
IRON, TOTAL	8820	3140	3000	5290 J	9450	1670
LEAD, TOTAL	9.7	6	8.7	8.9	10.1	4.6
MAGNESIUM, TOTAL	335	216	237	291	436	122
MANGANESE, TOTAL	3.2	3.7	4.6	4.9	3.2	1.8 U
MERCURY, TOTAL	0.1 U	0.1 U	0.09 U	0.11 UJ	0.12 U	0.11 U
NICKEL, TOTAL	2.5 U	2.5 U	0.7 U	0.98 U	2.7 U	0.69 U
POTASSIUM, TOTAL	390	161 U	142	146	333	90.9
SELENIUM, TOTAL	0.37 U	0.35 U	0.37 UJ	0.33 U	0.39 U	0.28 UJ
SILVER, TOTAL	0.68 U	0.71 R	0.42 U	0.59 U	0.74 U	0.41 U
SODIUM, TOTAL	29.9	20.3 U	16.7	22.6	32.6	12
VANADIUM, TOTAL	21.6	6.1	9.5	6	30.6	4.7
ZINC, TOTAL	2.5 U	1.4	1.9 U	2.5	3.5 U	0.88 U

UG/KG - microgram per kilogram
 J - value is estimated
 R - rejected
 U - not detected
 UJ - not detected, value is estimated

TABLE 4-6
 SUBSURFACE SOIL - POSITIVE DETECTION SUMMARY
 SITE 36, CAMP GEIGER AREA DUMP
 REMEDIAL INVESTIGATION, CTO-0303
 MCB, CAMP LEJEUNE, NORTH CAROLINA
 TAL METALS

LOCATION	36-FCA-SB09-02	36-FCA-SB10-02	36-FCA-SB11-03	36-FCA-SB12-02	36-FCA-SB13-01	36-FCA-SB14-01
DATE SAMPLED	02/22/95	02/22/95	02/23/95	02/22/95	02/27/95	02/23/95
DEPTH	3-5'	3-5'	5-7'	3-5'	1-3'	1-3'
ANALYTES (mg/kg)						
ALUMINUM, TOTAL	5760	2330	5650	1790	5620	5630
ANTIMONY, TOTAL	4.4 UJ	3.4 UJ	2.5 UJ	4.2 UJ	4.9 R	4.4 UJ
ARSENIC, TOTAL	0.54	0.26 U	0.43 U	0.39 U	0.44	0.74
BARIUM, TOTAL	9.1	4.7	8.2	4 U	7.6	13.6
BERYLLIUM, TOTAL	0.19 U	0.18	0.07 U	0.18 U	0.21 U	0.19 U
CADMIUM, TOTAL	0.6 U	0.46 U	0.65 U	0.57 U	0.67 U	0.59 U
CALCIUM, TOTAL	14.8	43.9	14.8 U	35.9	79.4 J	42.6
CHROMIUM, TOTAL	5.2	3.9	4.8 J	2	4.2 J	4.8
COBALT, TOTAL	0.64 U	0.73 U	0.52 U	0.61 U	0.71 U	0.63 U
COPPER, TOTAL	0.41 U	0.47 J	0.9 U	0.39 U	0.45 U	0.4 U
IRON, TOTAL	3500	620	2550 J	788	2590	2970
LEAD, TOTAL	8.5	3.7	7	2.4	8.3	3.9
MAGNESIUM, TOTAL	156	58.9	148	49.1	193	147
MANGANESE, TOTAL	1.7 U	1.7	2.5	1.7 U	2.5 J	8.1
MERCURY, TOTAL	0.11 U	0.1 U	0.09 UJ	0.08 U	0.087 U	0.08 U
NICKEL, TOTAL	2.3 U	1.8 U	0.94 U	2.2 U	2.7	2.3 U
POTASSIUM, TOTAL	147 U	113 U	106	139 U	163 U	144 U
SELENIUM, TOTAL	0.31 U	0.3 U	0.34 U	0.31 U	0.37 U	0.3 U
SILVER, TOTAL	0.64 U	0.49 UJ	0.56 U	0.61 U	0.71 U	0.63 U
SODIUM, TOTAL	25.1	19.4 U	14.3	10.8	15.8 U	20.5
VANADIUM, TOTAL	9.7	4.6	6.7	3 U	6.5	8.1
ZINC, TOTAL	1.6 U	1.3 J	0.99	0.77 U	0.99	2 U

UG/KG - microgram per kilogram
 J - value is estimated
 R - rejected
 U - not detected
 UJ - not detected, value is estimated

TABLE 4-6
 SUBSURFACE SOIL - POSITIVE DETECTION SUMMARY
 SITE 36, CAMP GEIGER AREA DUMP
 REMEDIAL INVESTIGATION, CTO-0303
 MCB, CAMP LEJEUNE, NORTH CAROLINA
 TAL METALS

LOCATION	36-FDA-SB01-02	36-FDA-SB02-04	36-FDA-SB03-04	36-FDA-SB04-01	36-FDA-SB05-01	36-FDA-SB06-07
DATE SAMPLED	02/23/95	02/27/95	02/22/95	02/24/95	02/27/95	02/25/95
DEPTH	3-5'	7-9'	7-9'	1-3'	1-3'	13-15'
ANALYTES (mg/kg)						
ALUMINUM, TOTAL	5920	1860	886	2940	19700	18200
ANTIMONY, TOTAL	13.3 J	3.6 R	2.4 UJ	4.9 J	6.2 J	4.5 UJ
ARSENIC, TOTAL	25.9	9.3	0.41 U	1.5	5.2	11.4
BARIUM, TOTAL	182	43.1	2.9	11.7	348	39.2
BERYLLIUM, TOTAL	0.21 U	0.16 U	0.07 U	0.16 U	0.25 U	0.2 U
CADMIUM, TOTAL	4.7	1.3	0.64 U	0.62 U	5.8	2.1 U
CALCIUM, TOTAL	12700	1750 J	69.4	227	2230	3850
CHROMIUM, TOTAL	35.1	8.6 J	1.4	5.9	32.5	39.1
COBALT, TOTAL	7.8	1.4 U	0.51 U	1.7	8.3	4.2
COPPER, TOTAL	133	33.1	0.88 U	16.6	399	67
IRON, TOTAL	81900	18100	529	13100	70500	47700
LEAD, TOTAL	457 J	190 J	1.2	33.8 J	424 J	143 J
MAGNESIUM, TOTAL	624	130	27	72.7	238	971
MANGANESE, TOTAL	1260	148 J	7.6	85.2	497	195
MERCURY, TOTAL	0.11 U	0.24	0.1 U	0.08 U	0.44	0.12 U
NICKEL, TOTAL	26.6	8.1	0.93 U	7	49.2	15.1
POTASSIUM, TOTAL	327	133	64.5 U	125 U	210	1640
SELENIUM, TOTAL	0.27 U	0.41 U	0.32 UJ	0.23 U	0.3 U	0.79
SILVER, TOTAL	0.69 U	0.52 U	0.55 U	0.55 U	0.52 U	0.66 U
SODIUM, TOTAL	150	60.9	16.7 U	19.8 U	61	501
VANADIUM, TOTAL	10.9	5.3	3.2	4.3	12.1	37.9
ZINC, TOTAL	2490	882	1.2 U	171	2580	1040

UG/KG - microgram per kilogram
 J - value is estimated
 R - rejected
 U - not detected
 UJ - not detected, value is estimated

TABLE 4-6
 SUBSURFACE SOIL - POSITIVE DETECTION SUMMARY
 SITE 36, CAMP GEIGER AREA DUMP
 REMEDIAL INVESTIGATION, CTO-0303
 MCB, CAMP LEJEUNE, NORTH CAROLINA
 TAL METALS

LOCATION	36-GW07-01	36-GW09-04	36-GW10-03	36-GW11-04	36-GW11-06	36-OA-SB01-01
DATE SAMPLED	03/07/95	03/09/95	03/09/95	03/09/95	03/09/95	02/22/95
DEPTH	1-3'	7-9'	5-7'	7-9'	11-13'	1-3'
ANALYTES (mg/kg)						
ALUMINUM, TOTAL	4630	5570	7770	8620	2740	2640
ANTIMONY, TOTAL	2.7 UJ	1.8 UJ	5.3 UJ	21.6 J	4.4 UJ	2.2 UJ
ARSENIC, TOTAL	0.4 U	6.2	0.53	13	0.92	6.6
BARIUM, TOTAL	6.8	24.3	12.8	475	4.3	9.9
BERYLLIUM, TOTAL	0.16 U	0.12 U	0.23 U	0.19 U	0.19 U	0.14 U
CADMIUM, TOTAL	0.73 U	38.5	0.71 U	42.8	0.6 U	0.59 U
CALCIUM, TOTAL	29.7 J	3270 J	141	24900	386	2920
CHROMIUM, TOTAL	4.5 U	29	7.4	71.9	5.6	3.4
COBALT, TOTAL	0.58 U	4.3	0.76 U	8.1	0.64 U	0.48
COPPER, TOTAL	1 U	82.5	0.61 U	782	1.1	3.7
IRON, TOTAL	2720 J	39300 J	3360	132000	2880	1570
LEAD, TOTAL	6.1 U	151	10	1980	5.1	16.6
MAGNESIUM, TOTAL	162	236	256	2700	205	129
MANGANESE, TOTAL	2.7	220	5.8	1150	11.9	7.3
MERCURY, TOTAL	0.12 U	0.088 U	0.13 U	0.8	0.1 U	0.11 U
NICKEL, TOTAL	1.1 U	24.1	2.7 U	40.1	2.3 U	1.3
POTASSIUM, TOTAL	101	153	183	739	288	91.9 U
SELENIUM, TOTAL	0.35 U	0.31 U	0.4 U	0.38 U	0.37 U	0.3 UJ
SILVER, TOTAL	0.63 U	0.41 U	0.76 U	0.89	0.64 U	0.51 U
SODIUM, TOTAL	14.3 U	65.8	33 U	491	66.6	23.2 U
VANADIUM, TOTAL	6	4.3	6.1	13.5	7.6	5.1
ZINC, TOTAL	1.3	1080	3.7	720	2	11.2

UG/KG - microgram per kilogram
 J - value is estimated
 R - rejected
 U - not detected
 UJ - not detected, value is estimated

TABLE 4-6
 SUBSURFACE SOIL - POSITIVE DETECTION SUMMARY
 SITE 36, CAMP GEIGER AREA DUMP
 REMEDIAL INVESTIGATION, CTO-0303
 MCB, CAMP LEJEUNE, NORTH CAROLINA
 TAL METALS

LOCATION	36-OA-SB01A-01	36-OA-SB01B-01	36-OA-SB01C-01	36-OA-SB01D-01	36-OA-SB02-03	36-OA-SB03-03
DATE SAMPLED	03/09/95	03/09/95	03/09/95	03/09/95	02/25/95	02/25/95
DEPTH	1-3'	1-3'	1-3'	1-3'	5-7'	5-7'
ANALYTES (mg/kg)						
ALUMINUM, TOTAL	3600	3380	3400	3950	2970	4850
ANTIMONY, TOTAL	4.8 UJ	4.2 UJ	4.4 UJ	4 UJ	4.5 UJ	4.5 UJ
ARSENIC, TOTAL	3.4	4.8 J	4.1 J	3.3 J	0.88	1.7
BARIUM, TOTAL	48	14.2	9.4	14.4	4.9	22.6
BERYLLIUM, TOTAL	0.21 U	0.18 U	0.19 U	0.17 U	0.2 U	0.2 U
CADMIUM, TOTAL	0.68	0.56 U	0.59 U	0.54 U	0.61 U	0.61 U
CALCIUM, TOTAL	535	588	2000	3640	42.7	4490
CHROMIUM, TOTAL	5.9	4.6	4.3	4.7	4.9	8.9
COBALT, TOTAL	0.7	0.77	0.63 U	0.58 U	0.65 U	0.66 U
COPPER, TOTAL	4.5	11.5	4.2	5.1	0.41 U	40.2
IRON, TOTAL	4260	2000	3180	3670	2450	8940
LEAD, TOTAL	30.2	13	5.5	23.2	3.6	209 J
MAGNESIUM, TOTAL	102	111	118	342	129	374
MANGANESE, TOTAL	7.6	9.4	15.5	20.5	2.9	46.4
MERCURY, TOTAL	0.12	0.1 U	0.11 U	0.09 U	0.1 U	0.09 U
NICKEL, TOTAL	2.5 U	2.2 U	2.3 U	2.1 U	2.4 U	3.2
POTASSIUM, TOTAL	160 U	138 U	145 U	133 U	149 U	183
SELENIUM, TOTAL	0.43	0.31 U	0.3 U	0.29 U	0.32 U	0.31 U
SILVER, TOTAL	0.7 U	0.6 U	0.63 U	0.58 U	0.65 R	0.66 R
SODIUM, TOTAL	34.1 U	11.8	12.5	11.4	16.5 U	38.9 U
VANADIUM, TOTAL	9.4	6.3	5.8	7.4	12.1	10.6
ZINC, TOTAL	17.1	57.8	19.4	14.3	1.5	111

UG/KG - microgram per kilogram
 J - value is estimated
 R - rejected
 U - not detected
 UJ - not detected, value is estimated

TABLE 4-6
 SUBSURFACE SOIL - POSITIVE DETECTION SUMMARY
 SITE 36, CAMP GEIGER AREA DUMP
 REMEDIAL INVESTIGATION, CTO-0303
 MCB, CAMP LEJEUNE, NORTH CAROLINA
 TAL METALS

LOCATION	36-OA-SB04-02	36-OA-SB05-02	36-OA-SB06-02	36-OA-SB07-01	36-OA-SB08-01	36-OF-SB01-04
DATE SAMPLED	02/24/95	02/28/95	02/27/95	02/24/95	02/27/95	02/21/95
DEPTH	3-5'	3-5'	3-5'	1-3'	1-3'	7-9'
ANALYTES (mg/kg)						
ALUMINUM, TOTAL	1280	752	2910	8690	3850	3290
ANTIMONY, TOTAL	4 UJ	2.5 R	2.2 R	16.2 J	2.2 UJ	2.4 UJ
ARSENIC, TOTAL	0.33 U	0.42 J	1.5 J	13.5	0.91	0.95
BARIUM, TOTAL	2.8	2	93.5	130	11.3	7.5
BERYLLIUM, TOTAL	0.17 U	0.07 U	0.06 U	0.21 U	0.18 U	0.07 U
CADMIUM, TOTAL	0.54 U	0.66 U	0.58 U	6.3	0.59 U	0.64 U
CALCIUM, TOTAL	167	84.3	402	15000	1570	350
CHROMIUM, TOTAL	2.2	1.5	4.2	34.4	3.6	4.5
COBALT, TOTAL	0.58 U	0.52 U	1.1 U	9.4	0.47 U	0.51 U
COPPER, TOTAL	0.46	0.99 U	4.6 U	163	0.88	0.89 U
IRON, TOTAL	475	408	5320	94600	1360	2490
LEAD, TOTAL	1.4	2.8	112	2680 J	7.7	3.3
MAGNESIUM, TOTAL	40.5	20.4	68.7	749	127	112
MANGANESE, TOTAL	2	1.8 U	38.3	842	6.7	5.3
MERCURY, TOTAL	0.1 U	0.1 U	0.1 U	3.9	0.089 U	0.1 U
NICKEL, TOTAL	2.1 U	0.95 U	10.3	39	0.86 U	0.93 U
POTASSIUM, TOTAL	132 U	47.2	48.1	307	70.1	121 U
SELENIUM, TOTAL	0.26 U	0.33 UJ	0.25 UJ	0.34 U	0.33 U	0.36 UJ
SILVER, TOTAL	0.58 U	0.68	0.5 U	0.69 U	0.51 U	0.55 U
SODIUM, TOTAL	17.9 U	9.5	5.2	138	20.6 U	18.1 U
VANADIUM, TOTAL	3.3	1.6	2.1	17	4	8.6
ZINC, TOTAL	0.85	1.4 U	122	1020	10	2.5

UG/KG - microgram per kilogram
 J - value is estimated
 R - rejected
 U - not detected
 UJ - not detected, value is estimated

TABLE 4-6
SUBSURFACE SOIL - POSITIVE DETECTION SUMMARY
SITE 36, CAMP GEIGER AREA DUMP
REMEDIAL INVESTIGATION, CTO-0303
MCB, CAMP LEJEUNE, NORTH CAROLINA
TAL METALS

LOCATION	36-OF-SB02-02	36-OF-SB03-03	36-OF-SB04-04	36-OF-SB05-06	36-OF-SB06-03	36-OF-SB06A-01
DATE SAMPLED	02/21/95	02/21/95	02/22/95	02/21/95	02/21/95	03/09/95
DEPTH	3-5'	5-7'	7-9'	11-13'	5-7'	1-3'
ANALYTES (mg/kg)						
ALUMINUM, TOTAL	787	7720	13700	5520	13900	3560
ANTIMONY, TOTAL	3.5 UJ	3.6 UJ	4.1 UJ	3.8 UJ	2.8 UJ	2.5 UJ
ARSENIC, TOTAL	0.26 U	0.44	6.7	1.2	6.8	5.8
BARIUM, TOTAL	2.1	14	25.4	11.8	18.5	147
BERYLLIUM, TOTAL	0.17	0.16 U	0.18 U	0.17 U	0.14 U	0.074 U
CADMIUM, TOTAL	0.48 U	0.49 U	0.56 U	0.51 U	0.74 U	0.74
CALCIUM, TOTAL	271	890	2850	1250	1880	41900 J
CHROMIUM, TOTAL	1.8	11.1	27.7	9.1	34.7	14.2
COBALT, TOTAL	0.51 U	0.81 U	0.69 U	1.4 U	1.6	2.8 U
COPPER, TOTAL	0.5 J	0.87 J	3.1 J	17.9 J	3.9	38.7
IRON, TOTAL	695	7430	22800	10300	58400	28400 J
LEAD, TOTAL	2.1 J	5.1	17.4	37.6	11.2	871
MAGNESIUM, TOTAL	20.2	283	642	333	523	652
MANGANESE, TOTAL	0.85	50.9	7.5	45.4	48.3	169
MERCURY, TOTAL	0.08 U	0.11 U	0.11 U	0.1 U	0.42	0.28
NICKEL, TOTAL	6.1	1.9 U	5.4	4	1.1 U	28.6
POTASSIUM, TOTAL	117 U	438	745	388	630	115
SELENIUM, TOTAL	0.3 U	0.32 U	0.56	0.3 U	1.2 J	0.34 U
SILVER, TOTAL	0.51 UJ	0.52 UJ	0.6 UJ	0.55 UJ	0.64 U	0.58 U
SODIUM, TOTAL	14.4 U	45.2	60.7	81.7	64.6 U	97.8
VANADIUM, TOTAL	2.3 U	20.2	40.4	10.4	52.6	6.5
ZINC, TOTAL	2.3	18.2	7.6	201	92.1	363

UG/KG - microgram per kilogram

J - value is estimated

R - rejected

U - not detected

UJ - not detected, value is estimated

TABLE 4-6
 SUBSURFACE SOIL - POSITIVE DETECTION SUMMARY
 SITE 36, CAMP GEIGER AREA DUMP
 REMEDIAL INVESTIGATION, CTO-0303
 MCB, CAMP LEJEUNE, NORTH CAROLINA
 TAL METALS

LOCATION	36-OF-SB06B-02	36-OF-SB06C-02	36-OF-SB06D-02
DATE SAMPLED	03/09/95	03/09/95	03/09/95
DEPTH	3-5'	3-5'	3-5'
ANALYTES (mg/kg)			
ALUMINUM, TOTAL	5650	4320	3710
ANTIMONY, TOTAL	5.8 J	3.8 UJ	6.4 J
ARSENIC, TOTAL	12.9	0.23	2.4
BARIUM, TOTAL	246	12.4	53.2
BERYLLIUM, TOTAL	0.2 U	0.16 U	0.18 U
CADMIUM, TOTAL	12.7	0.51 U	2.4
CALCIUM, TOTAL	46300	343	16300
CHROMIUM, TOTAL	26.7	2.3	18.5
COBALT, TOTAL	5.4	0.55 U	3.3
COPPER, TOTAL	1320	2.5	129
IRON, TOTAL	67400	2130	45100
LEAD, TOTAL	1210	12.6	555
MAGNESIUM, TOTAL	885	123	408
MANGANESE, TOTAL	560	9.5	376
MERCURY, TOTAL	0.13 U	0.08 U	0.75
NICKEL, TOTAL	40.4	2 U	15.1
POTASSIUM, TOTAL	375	125 U	255
SELENIUM, TOTAL	0.43 U	0.3 U	0.42 U
SILVER, TOTAL	0.66 U	0.55 U	0.61 U
SODIUM, TOTAL	235	23.1 U	56.6
VANADIUM, TOTAL	10.4	4.4	8.3
ZINC, TOTAL	1540	9.4	647

UG/KG - microgram per kilogram
 J - value is estimated
 R - rejected
 U - not detected
 UJ - not detected, value is estimated

TABLE 4-7
GROUNDWATER - POSITIVE DETECTION SUMMARY
ROUND 1
SITE 36, CAMP GEIGER AREA DUMP
REMEDIAL INVESTIGATION, CTO-0303
MCB, CAMP LEJEUNE, NORTH CAROLINA
TCL ORGANICS

LOCATION DATE SAMPLED	36-GW01-01 03/28/95	36-GW02-01 03/27/95	36-GW03-01 03/26/95	36-GW04-01 03/26/95	36-GW05-01 03/26/95	36-GW06-01 03/27/95
VOLATILES (ug/l)						
1,2-DICHLOROETHENE (TOTAL)	10 U	10 U	10 U	4 J	10 U	10 U
TRICHLOROETHENE	10 U	10 U	10 U	10 U	10 U	10 U
1,1,2,2-TETRACHLOROETHANE	10 U	10 U	10 U	10 U	10 U	10 U
SEMIVOLATILES (ug/l)						
BIS(2-ETHYLHEXYL)PHTHALATE	10 U	10 U	10 U	10 U	9 U	10 U
PESTICIDES/PCBs (ug/l)						
4,4'-DDD	0.093 U	0.1 UJ	0.092 U	0.097 UJ	0.095 UJ	0.096 UJ

UG/L - microgram per liter
 J - value is estimated
 NA - not analyzed
 U - not detected
 UJ - not detected, value is estimated

TABLE 4-7
GROUNDWATER - POSITIVE DETECTION SUMMARY
ROUND 1
SITE 36, CAMP GEIGER AREA DUMP
REMEDIAL INVESTIGATION, CTO-0303
MCB, CAMP LEJEUNE, NORTH CAROLINA
TCL ORGANICS

LOCATION DATE SAMPLED	36-GW06DW-01 03/26/95	36-GW07-01 03/26/95	36-GW07DW-01 03/26/95	36-GW08-01 03/27/95	36-GW09-01 03/27/95	36-GW10-01 03/25/95
VOLATILES (ug/l)						
1,2-DICHLOROETHENE (TOTAL)	10 U	10 U	10 U	5 J	10 U	10 U
TRICHLOROETHENE	10 U	10 U	10 U	10 U	10 U	8 J
1,1,2,2-TETRACHLOROETHANE	10 U	10 U	10 U	10 U	10 U	10 U
SEMIVOLATILES (ug/l)						
BIS(2-ETHYLHEXYL)PHTHALATE	10 U	9 U	10 U	10 U	5 J	10 U
PESTICIDES/PCBs (ug/l)						
4,4'-DDD	0.096 UJ	0.095 UJ	0.094 UJ	0.093 U	0.1 UJ	0.056 J

UG/L - microgram per liter
 J - value is estimated
 NA - not analyzed
 U - not detected
 UJ - not detected, value is estimated

TABLE 4-7
GROUNDWATER - POSITIVE DETECTION SUMMARY
ROUND 1
SITE 36, CAMP GEIGER AREA DUMP
REMEDIAL INVESTIGATION, CTO-0303
MCB, CAMP LEJEUNE, NORTH CAROLINA
TCL ORGANICS

LOCATION DATE SAMPLED	36-GW10IW-01 05/09/95	36-GW10DW-01 07/12/95	36-GW11-01 03/27/95	36-GW11DW-01 03/27/95	36-GW12-01 05/08/95	36-GW12IW-01 05/08/95
VOLATILES (ug/l)						
1,2-DICHLOROETHENE (TOTAL)	31 J	10 U	10 U	10 U	10 UJ	10 UJ
TRICHLOROETHENE	70	10 U	10 U	10 U	9 J	10 U
1,1,2,2-TETRACHLOROETHANE	10	10 U	10 U	10 U	6 J	10 U
SEMIVOLATILES (ug/l)						
BIS(2-ETHYLHEXYL)PHTHALATE	NA	10 U	10 U	10 U	NA	NA
PESTICIDES/PCBs (ug/l)						
4,4'-DDD	NA	0.096 UJ	0.095 U	0.095 UJ	NA	NA

UG/L - microgram per liter
 J - value is estimated
 NA - not analyzed
 U - not detected
 UJ - not detected, value is estimated

TABLE 4-7
GROUNDWATER - POSITIVE DETECTION SUMMARY
ROUND 1
SITE 36, CAMP GEIGER AREA DUMP
REMEDIAL INVESTIGATION, CTO-0303
MCB, CAMP LEJEUNE, NORTH CAROLINA
TCL ORGANICS

LOCATION DATE SAMPLED	36-GW13-01 05/09/95	36-GW13IW-01 05/08/95	36-GW14-01 05/08/95	36-TW01-01 03/15/95	36-TW02-01 03/14/95
VOLATILES (ug/l)					
1,2-DICHLOROETHENE (TOTAL)	8 J	14 J	10 UJ	10 U	10 U
TRICHLOROETHENE	6 J	3 J	10 U	10 U	10 U
1,1,2,2-TETRACHLOROETHANE	10 U	10 U	10 U	10 U	10 U
SEMIVOLATILES (ug/l)					
BIS(2-ETHYLHEXYL)PHTHALATE	NA	NA	NA	1 J	11 U
PESTICIDES/PCBs (ug/l)					
4,4'-DDD	NA	NA	NA	0.11 UJ	0.1 UJ

UG/L - microgram per liter
 J - value is estimated
 NA - not analyzed
 U - not detected
 UJ - not detected, value is estimated

TABLE 4-8
GROUNDWATER - POSITIVE DETECTION SUMMARY
ROUND 1
SITE 36, CAMP GEIGER AREA DUMP
REMEDIAL INVESTIGATION, CTO-0303
MCB, CAMP LEJEUNE, NORTH CAROLINA
TAL METALS

LOCATION DATE SAMPLED	36-GW01-01 03/28/95	36-GW02-01 03/27/95	36-GW03-01 03/26/95	36-GW04-01 03/26/95	36-GW05-01 03/26/95	36-GW06-01 03/27/95
ANALYTE (ug/l)						
ALUMINUM, TOTAL	58.3 U	64.9 U	21.9	128	143	590
ARSENIC, TOTAL	3.6	3.4	1.9 U	1.9 U	1.9 U	1.9 U
BARIUM, TOTAL	290	69	4.4 U	81.5	43.9	61.5
CADMIUM, TOTAL	2.8 U	2.8 U	2.9 U	2.9 U	2.9 U	2.9 U
CALCIUM, TOTAL	139000	92300	1740	27300	18100	6110
IRON, TOTAL	13300 J	16900 J	160	32.8	692	4870
LEAD, TOTAL	1.6 U	1.6 U	1.6 U	1.6 U	1.6 U	1.6 U
MAGNESIUM, TOTAL	13000	28900	274	4420	3830	2630
MANGANESE, TOTAL	1150	452	54.5	19.2	4.9 U	22.3
MERCURY, TOTAL	0.2 U	0.2 U	0.2 U	0.2 U	0.2 U	0.2 U
NICKEL, TOTAL	10.8 U	10.8 U	4.2 U	4.2 U	4.2 U	4.2 U
POTASSIUM, TOTAL	11600	37500	2470	1340	620	854
SELENIUM, TOTAL	1.4 U	1.4 U	1.5 U	1.6	1.5 U	1.5 U
SODIUM, TOTAL	14800	46400	42200	11200	10600	11600
VANADIUM, TOTAL	2.3 U	2.3 U	2.1 U	2.1 U	2.1 U	2.1 U
ZINC, TOTAL	3.8 U	3.8 U	1.9 U	1.9 U	1.9 U	1.9 U

UG/L - microgram per liter
J - value is estimated
U - not detected
UJ - not detected, value is estimated

TABLE 4-8
GROUNDWATER - POSITIVE DETECTION SUMMARY
ROUND 1
SITE 36, CAMP GEIGER AREA DUMP
REMEDIAL INVESTIGATION, CTO-0303
MCB, CAMP LEJEUNE, NORTH CAROLINA
TAL METALS

LOCATION DATE SAMPLED	36-GW06DW-01 03/26/95	36-GW07-01 03/26/95	36-GW07DW-01 03/26/95	36-GW08-01 03/27/95	36-GW09-01 03/27/95	36-GW10-01 03/25/95
ANALYTE (ug/l)						
ALUMINUM, TOTAL	16.8 U	16.8 U	16.8 U	136 U	72.9	16.8 U
ARSENIC, TOTAL	1.9 U	1.9 U	1.9 U	1.6 U	1.9 U	1.9 U
BARIUM, TOTAL	2.9 U	12.3	2.8 U	54.5	45.8	49.2
CADMIUM, TOTAL	2.9 U	2.9 U	2.9 U	2.8 U	2.9 U	2.9 U
CALCIUM, TOTAL	45700	70600	42500	28600	165000	121000
IRON, TOTAL	49.5	341	27.4	172 J	2880	3.3
LEAD, TOTAL	1.6 U	1.6 U	1.6 U	1.6 U	1.6 U	1.6 U
MAGNESIUM, TOTAL	2580	1930	2020	4430	41500	5960
MANGANESE, TOTAL	34.7	37.7	40.8	21.1	3180	207
MERCURY, TOTAL	0.2 U	0.2 U	0.2 U	0.2 U	0.2 U	0.2 U
NICKEL, TOTAL	4.2 U	4.2 U	4.2 U	10.8 U	7.4	4.2 U
POTASSIUM, TOTAL	5930	1230	4260	6450	26000	1150
SELENIUM, TOTAL	1.5 U	1.5 U	1.5 U	1.4 U	1.5 UJ	1.5 U
SODIUM, TOTAL	33400	13500	33100	17700	49100	12800
VANADIUM, TOTAL	2.1 U	2.3 U	2.1 U	2.3 U	2.1 U	2.1 U
ZINC, TOTAL	166	1.9 U	1.9 U	16.8 U	224	1.9 U

UG/L - microgram per liter
 J - value is estimated
 U - not detected
 UJ - not detected, value is estimated

TABLE 4-8
GROUNDWATER - POSITIVE DETECTION SUMMARY
ROUND 1
SITE 36, CAMP GEIGER AREA DUMP
REMEDIAL INVESTIGATION, CTO-0303
MCB, CAMP LEJEUNE, NORTH CAROLINA
TAL METALS

LOCATION DATE SAMPLED	36-GW10IW-01 05/09/95	36-GW10DW-01 07/12/95	36-GW11-01 03/27/95	36-GW11DW-01 03/27/95	36-GW12-01 05/08/95	36-GW12IW-01 05/08/95
ANALYTE (ug/l)						
ALUMINUM, TOTAL	88.4 U	56.3	31.2 U	16.8 U	705	36.8 U
ARSENIC, TOTAL	1.5 U	1.8 U	1.6 U	1.9 U	1.5 U	1.5 U
BARIUM, TOTAL	28.4	15.1	57.8	11.5	41.2	52.2
CADMIUM, TOTAL	3.9 U	3.7 U	2.8 U	3	3.9 U	3.9 U
CALCIUM, TOTAL	159000	39000	191000	50400	106000	102000
IRON, TOTAL	101	18.9	375 J	106	686	17.1 U
LEAD, TOTAL	1.6 U	2.2	1.6 U	1.6 U	3.4 U	14.7
MAGNESIUM, TOTAL	11300	16000	42800	21700	4690	4030
MANGANESE, TOTAL	92.4	2.2	126	84	44.6	51.3
MERCURY, TOTAL	0.2 U	0.2 U	0.2 U	0.2 U	0.2 U	0.2 U
NICKEL, TOTAL	5.4 U	4.8 U	10.8 U	4.2 U	5.4 U	5.4 U
POTASSIUM, TOTAL	3850	24700	37900	20100	2650	3210
SELENIUM, TOTAL	1.8 U	1.6 U	3.3	1.5 U	1.8 U	1.8 U
SODIUM, TOTAL	41300	61700	46100	70700	13900	19200
VANADIUM, TOTAL	1.5 U	6.7	2.3 U	2.1 U	2.9 U	1.5 U
ZINC, TOTAL	2.5 U	3.7	6.5 U	1.9 U	3.9 U	2.8 U

UG/L - microgram per liter
J - value is estimated
U - not detected
UJ - not detected, value is estimated

TABLE 4-8
GROUNDWATER - POSITIVE DETECTION SUMMARY
ROUND 1
SITE 36, CAMP GEIGER AREA DUMP
REMEDIAL INVESTIGATION, CTO-0303
MCB, CAMP LEJEUNE, NORTH CAROLINA
TAL METALS

LOCATION DATE SAMPLED	36-GW13-01 05/09/95	36-GW13IW-01 05/08/95	36-GW14-01 05/08/95	36-TW02-01 03/14/95
ANALYTE (ug/l)				
ALUMINUM, TOTAL	41.1 U	58 U	386	155 U
ARSENIC, TOTAL	1.5 U	1.5 U	1.5 U	1.9 U
BARIUM, TOTAL	23.2	12.3	36.7	204
CADMIUM, TOTAL	3.9 U	3.9 U	3.9 U	2.8 U
CALCIUM, TOTAL	120000	76300	47800	68400
IRON, TOTAL	337	425	6650	7640
LEAD, TOTAL	1.9 U	12.7	0.9 U	1 U
MAGNESIUM, TOTAL	4640	9590	2480	36200
MANGANESE, TOTAL	183	66.6	31.6	210
MERCURY, TOTAL	0.2 U	0.2 U	0.2 U	1.4
NICKEL, TOTAL	5.4 U	5.4 U	5.4 U	65.2
POTASSIUM, TOTAL	2310	5060	758	15300
SELENIUM, TOTAL	1.8 U	1.8 U	1.8 U	1.5 U
SODIUM, TOTAL	13000	40200	6710	308000
VANADIUM, TOTAL	1.5 U	1.5 U	1.5 U	2.6
ZINC, TOTAL	2.4 U	2.2 U	4.7 U	8.5

UG/L - microgram per liter
 J - value is estimated
 U - not detected
 UJ - not detected, value is estimated

TABLE 4-9
GROUNDWATER - POSITIVE DETECTION SUMMARY
ROUND 1
SITE 36, CAMP GEIGER AREA DUMP
REMEDIAL INVESTIGATION, CTO-0303
MCB, CAMP LEJEUNE, NORTH CAROLINA
TAL DISSOLVED METALS

LOCATION	36-GW01D-01	36-GW08D-01	36-GW14D-01	36-TW02D-01
DATE SAMPLED	03/28/95	03/27/95	05/08/95	03/14/95
ANALYTE (ug/l)				
ARSENIC, SOLUBLE	1.9	1.6 U	1.5 U	1.9 U
BARIUM, SOLUBLE	278	57.7	35	200
CALCIUM, SOLUBLE	134000	28000	49700	68500
IRON, SOLUBLE	12700 J	155 J	5570	7170
MAGNESIUM, SOLUBLE	12400	4580	2500	36200
MANGANESE, SOLUBLE	1110	24.5	32.7	208
NICKEL, SOLUBLE	10.8 U	10.8 U	5.4 U	66.4
POTASSIUM, SOLUBLE	10500	6690	793	15900
SODIUM, SOLUBLE	14200	18600	6700	313000
ZINC, SOLUBLE	4.8 U	12.2 U	3.1 U	10.4

UG/L - microgram per liter
 J - value is estimated
 U - not detected

TABLE 4-10
GROUNDWATER - POSITIVE DETECTION SUMMARY
ROUND 2
SITE 36, CAMP GEIGER AREA DUMP
REMEDIAL INVESTIGATION, CTO-0303
MCB, CAMP LEJEUNE, NORTH CAROLINA
TCL ORGANICS

LOCATION DATE SAMPLED	36-GW10-02 07/11/95	36-GW10IW-02 07/11/95	36-GW12-02 07/11/95	36-GW12IW-02 07/11/95	36-GW13-02 07/11/95	36-GW13IW-02 07/11/95
VOLATILES (ug/l)						
METHYLENE CHLORIDE	1 J	10 U	10 U	10 U	10 U	10 U
1,2-DICHLOROETHENE (TOTAL)	10 U	37	10 U	10 U	13	9 J
TRICHLOROETHENE	10	97	4 J	10 U	5 J	3 J
TETRACHLOROETHENE	1 J	2 J	10 U	10 U	10 U	10 U
1,1,2,2-TETRACHLOROETHANE	3 J	8 J	3 J	10 U	4 J	10 U
SEMIVOLATILES (ug/l)						
BIS(2-ETHYLHEXYL)PHTHALATE	NA	NA	NA	NA	NA	NA
PESTICIDES/PCB's (ug/l)						
4,4'-DDD	ND	NA	NA	NA	NA	NA

UG/L - microgram per liter
J - value is estimated
U - not detected
NA - not analyzed
ND - not detected

TABLE 4-11
SURFACE WATER - POSITIVE DETECTION SUMMARY
SITE 36, CAMP GEIGER AREA DUMP
REMEDIAL INVESTIGATION, CTO-0303
MCB, CAMP LEJEUNE, NORTH CAROLINA
TCL ORGANICS

LOCATION	36-SW01	36-SW02	36-SW03	36-SW04	36-SW05	36-SW06
DATE SAMPLED	04/09/94	04/19/94	04/19/94	04/19/94	04/18/94	04/18/94
VOLATILES (ug/l)						
1,2-Dichloroethene (total)	10 U	7	10 U	10 U	10 UJ	10 UJ

UG/L - microgram per liter
 U - not detected
 UJ - not detected, value is estimated

TABLE 4-11
SURFACE WATER - POSITIVE DETECTION SUMMARY
SITE 36, CAMP GEIGER AREA DUMP
REMEDIAL INVESTIGATION, CTO-0303
MCB, CAMP LEJEUNE, NORTH CAROLINA
TCL ORGANICS

LOCATION	36-SW07
DATE SAMPLED	04/18/94
VOLATILES (ug/l)	
1,2-Dichloroethene (total)	10 UJ

UG/L - microgram per liter
U - not detected
UJ - not detected, value is estimated

TABLE 4-12
 SURFACE WATER - POSITIVE DETECTION SUMMARY
 SITE 36, CAMP GEIGER AREA DUMP
 REMEDIAL INVESTIGATION, CTO-0303
 MCB, CAMP LEJEUNE, NORTH CAROLINA
 TAL METALS

LOCATION DATE SAMPLED	36-SW01 04/19/94	36-SW02 04/19/94	36-SW03 04/19/94	36-SW04 04/19/94	36-SW05 04/18/94	36-SW06 04/18/94
ANALYTES (UG/L)						
Aluminum	1 U	1 U	2.4	1 U	1.3	1.2 J
Antimony	2 J	1 U	2.8	1.9 J	3.9	1 U
Barium	12.1	27.3	39.8	22.2 U	19.6 U	18.2 U
Calcium	19500	44400	44300 U	33700	41700	44000
Copper	56.5	15.8 U	16.5 U	12.3 U	7 U	8 U
Iron	2710 J	2320 J	4840 J	1370 J	967 J	1070 J
Magnesium	719 U	1550	7850	6420	17900	13200
Manganese	58.4	91.2	126	12.7 U	31.9	29.5
Molybdenum	33 UJ	33 UJ	50 J	35 J	65 J	57 J
Nickel	28.3	31.4	16.4	23.2	10 U	10 U
Potassium	18800	5310	8020	6170	8210	7490
Sodium	330000	99500	82000	95500	192000	136000
Thallium	1 UJ	1 UJ	1 UJ	1.1 J	1 UJ	1 UJ
Vanadium	387	131	79	85	11.2	9
ANALYTE						
Hardness mg/L CaCO3	74	122	130	116	194	180

UG/L - microgram per liter
 J - value is estimated
 U - not detected
 UJ - not detected, value is estimated

TABLE 4-12
SURFACE WATER - POSITIVE DETECTION SUMMARY
SITE 36, CAMP GEIGER AREA DUMP
REMEDIAL INVESTIGATION, CTO-0303
MCB, CAMP LEJEUNE, NORTH CAROLINA
TAL METALS

LOCATION	36-SW07
DATE SAMPLED	04/18/94
ANALYTES (UG/L)	
Aluminum	1
Antimony	2.4 J
Barium	18.3 U
Calcium	48800
Copper	5.3 U
Iron	1380 J
Magnesium	9300
Manganese	24.5
Molybdenum	46 J
Nickel	10 U
Potassium	5920
Sodium	103000
Thallium	1 UJ
Vanadium	4.5
ANALYTE	
Hardness mg/L CaCO ₃	158

UG/L - microgram per liter
 J - value is estimated
 U - not detected
 UJ - not detected, value is estimated

TABLE 4-13
 SURFACE WATER - POSITIVE DETECTION SUMMARY
 SITE 36, CAMP GEIGER AREA DUMP
 REMEDIAL INVESTIGATION, CTO-0303
 MCB, CAMP LEJEUNE, NORTH CAROLINA
 TAL DISSOLVED METALS

LOCATION DATE SAMPLED	36-DSW01 05/05/95	36-DSW02 05/05/95	36-DSW03 05/05/95	36-DSW04 05/05/95	36-DSW05 05/05/95	36-DSW06 05/05/95
ANALYTE (ug/l)						
ALUMINUM, SOLUBLE	37.9	21.2 U	21.2 U	21.2 U	21.2 U	62
BARIUM, SOLUBLE	5.3	19.1	11.7	32.6	25	22.6
CADMIUM, SOLUBLE	1.9 U	1.9 U	1.9 U	1.9 U	1.9 U	2.7
CALCIUM, SOLUBLE	9470	40300	30200	86400	107000	110000
COBALT, SOLUBLE	4.1	3.4 U	3.4 U	3.4 U	3.4 U	3.4 U
COPPER, SOLUBLE	19	4.9	3.4	2.6	4.8	1.8 U
IRON, SOLUBLE	1340	1630	1240	145	29.6 U	23.6 U
LEAD, SOLUBLE	9.8 J	15.6 J	9.1 J	0.8 J	0.8 UJ	0.8 UJ
MAGNESIUM, SOLUBLE	688	1420	1910	187000	271000	271000
MANGANESE, SOLUBLE	83.5	63.6	28.6	50.9	23.8	26.6
NICKEL, SOLUBLE	29.9	21.2	20.4	10.9 U	10.9 U	10.9 U
POTASSIUM, SOLUBLE	6080 J	4560 J	4090 J	64900 J	94500 J	95900 J
SODIUM, SOLUBLE	159000	90100	73400	1570000	2180000	2190000
VANADIUM, SOLUBLE	243	143	81	41.5	5.6	2 U
ZINC, SOLUBLE	32.8	24	14.1	8.5	6 U	6 U

UG/L - microgram per liter
 J - value is estimated
 U - not detected
 UJ - not detected, value is estimated

TABLE 4-13
 SURFACE WATER - POSITIVE DETECTION SUMMARY
 SITE 36, CAMP GEIGER AREA DUMP
 REMEDIAL INVESTIGATION, CTO-0303
 MCB, CAMP LEJEUNE, NORTH CAROLINA
 TAL DISSOLVED METALS

LOCATION	36-DSW07
DATE SAMPLED	05/05/95
ANALYTE (ug/l)	
ALUMINUM, SOLUBLE	21.2 U
BARIUM, SOLUBLE	22.4
CADMIUM, SOLUBLE	2.2
CALCIUM, SOLUBLE	108000
COBALT, SOLUBLE	3.4 U
COPPER, SOLUBLE	4.3
IRON, SOLUBLE	29.3 U
LEAD, SOLUBLE	0.8 UJ
MAGNESIUM, SOLUBLE	258000
MANGANESE, SOLUBLE	27
NICKEL, SOLUBLE	10.9 U
POTASSIUM, SOLUBLE	90900 J
SODIUM, SOLUBLE	2050000
VANADIUM, SOLUBLE	2 U
ZINC, SOLUBLE	6 U

UG/L - microgram per liter
 J - value is estimated
 U - not detected
 UJ - not detected, value is estimated

TABLE 4-14
SEDIMENT - POSITIVE DETECTION SUMMARY
SITE 36, CAMP GEIGER AREA DUMP
REMEDIAL INVESTIGATION, CTO-0303
MCB, CAMP LEJEUNE, NORTH CAROLINA
TCL ORGANICS

Client Sample ID:	36-SD01-06	36-SD02-06	36-SD02-612	36-SD03-06	36-SD03-612	36-SD04-06
DATE SAMPLED	05/18/94	05/17/94	05/17/94	05/18/94	05/18/94	08/08/95
DEPTH	0-6"	0-6"	6-12"	0-6"	6-12"	0-6"
VOLATILES (ug/kg)						
Tetrachloroethene	16 U	12 U	13 U	29 U	26 U	15 U
SEMIVOLATILES (ug/kg)						
Diethylphthalate	532 U	330 J	440 U	956 U	896	490 U
Anthracene	532 U	407 U	440 U	956 U	866 U	490 U
Di-n-butylphthalate	532 U	407 U	440 U	956 U	866 U	490 U
Pyrene	532 U	407 U	316 J	956 U	866 U	490 U
bis(2-Ethylhexyl)phthalate	532 U	242 J	328 J	956 UJ	866 UJ	490 U
PESTICIDES/PCBs (ug/kg)						
Aldrin	0.93 J	21 U	11 U	25 U	45 U	2.5 UJ
Dieldrin	0.8 J	41 U	22 U	48 U	87 U	4.9 U
4,4'-DDE	5.3 U	66 J	22 U	169	87 U	120 J
Endrin	2.7 U	21 U	6.6 J	25 U	45 U	4.9 U
4,4'-DDD	15	130	14 P	606	1030	250
Endosulfan sulfate	5.3 U	41 U	3 J	48 U	87 U	4.9 U
4,4'-DDT	5.3 U	8.5 J	7.4 J	18 J	11 J	3 J
Endrin ketone	5.3 U	41 U	22 U	11 J	87 U	4.9 U
Endrin aldehyde	5.3 U	41 U	3.5 J	48 U	87 U	4.9 U
alpha-Chlordane	2.7 U	21 U	11 U	25 U	45 U	2.5 U

UG/KG - microgram per kilogram
 J - value is estimated
 P - estimated value, 25% difference between concentrations of
 the initial and confirmatory columns
 U - not detected
 UJ - not detected, value is estimated

TABLE 4-14
SEDIMENT - POSITIVE DETECTION SUMMARY
SITE 36, CAMP GEIGER AREA DUMP
REMEDIAL INVESTIGATION, CTO-0303
MCB, CAMP LEJEUNE, NORTH CAROLINA
TCL ORGANICS

Client Sample ID:	36-SD04-612	36-SD05-06	36-SD05-612	36-SD06-06	36-SD06-612	36-SD07-06
DATE SAMPLED	08/08/95	05/18/94	05/18/94	05/18/94	05/18/94	05/18/94
DEPTH	6-12"	0-6"	6-12"	0-6"	6-12"	0-6"
VOLATILES (ug/kg)						
Tetrachloroethene	4 J	53 UJ	17 U	11 U	12 UJ	11 U
SEMIVOLATILES (ug/kg)						
Diethylphthalate	460 U	2135 J	1650 U	425 UJ	411 U	2640 U
Anthracene	46 J	1737 UJ	1650 U	425 U	411 U	2640 U
Di-n-butylphthalate	460 U	1737 UJ	1650 U	425 UJ	218 J	2640 U
Pyrene	460 U	1737 U	1650 U	425 U	411 U	2640 U
bis(2-Ethylhexyl)phthalate	460 U	1737 UJ	1650 UJ	425 UJ	411 UJ	2640 UJ
PESTICIDES/PCBs (ug/kg)						
Aldrin	23 UJ	8.9 U	120 U	24 U	24 U	25 U
Dieldrin	45 U	17 U	232 U	52	46 U	48 U
4,4'-DDE	1000 UJ	242 J	1200	249	179	51
Endrin	45 U	8.9 U	120 U	24 U	24 U	25 U
4,4'-DDD	3600 UJ	223 J	1140	221	159	74
Endosulfan sulfate	45 U	17 U	232 U	47 U	46 U	48 U
4,4'-DDT	27 J	31 J	46 J	14 J	8 J	48 U
Endrin ketone	45 U	17 U	232 U	47 U	46 U	48 U
Endrin aldehyde	45 U	7.6 J	232 U	47 U	46 U	48 U
alpha-Chlordane	23 U	8.9 U	120 U	24 U	24 U	13 J

UG/KG - microgram per kilogram
J - value is estimated
P - estimated value, 25% difference between concentrations of
the initial and confirmatory columns
U - not detected
UJ - not detected, value is estimated

TABLE 4-14
SEDIMENT - POSITIVE DETECTION SUMMARY
SITE 36, CAMP GEIGER AREA DUMP
REMEDIAL INVESTIGATION, CTO-0303
MCB, CAMP LEJEUNE, NORTH CAROLINA
TCL ORGANICS

Client Sample ID:	36-SD07-612
DATE SAMPLED	05/18/94
DEPTH	6-12"
VOLATILES (ug/kg)	
Tetrachloroethene	45 U
SEMIVOLATILES (ug/kg)	
Diethylphthalate	1480 U
Anthracene	1480 U
Di-n-butylphthalate	1480 U
Pyrene	1480 U
bis(2-Ethylhexyl)phthalate	1480 UJ
PESTICIDES/PCBs (ug/kg)	
Aldrin	24 U
Dieldrin	14 J
4,4'-DDE	32 J
Endrin	24 U
4,4'-DDD	41
Endosulfan sulfate	47 U
4,4'-DDT	5.7 J
Endrin ketone	47 U
Endrin aldehyde	47 U
alpha-Chlordane	6.5 J

UG/KG - microgram per kilogram
 J - value is estimated
 P - estimated value, 25% difference between concentrations of
 the initial and confirmatory columns
 U - not detected
 UJ - not detected, value is estimated

TABLE 4-15
 SEDIMENT - POSITIVE DETECTION SUMMARY
 SITE 36, CAMP GEIGER AREA DUMP
 REMEDIAL INVESTIGATION, CTO-0303
 MCB, CAMP LEJEUNE, NORTH CAROLINA
 TAL METALS

LOCATION	36-SD01-06	36-SD02-06	36-SD02-612	36-SD03-06	36-SD03-612	36-SD04-06
DATE SAMPLED	05/18/94	05/17/94	05/17/94	05/18/94	05/18/94	08/08/95
DEPTH	0-6"	0-6"	6-12"	0-6"	6-12"	0-6"
ANALYTES (mg/kg)						
Aluminum	26300	3720	4320	6080	9510	1890 J
Arsenic	1.6 R	0.99 J	2.1 J	2 J	1.4 J	0.71
Barium	79.1	11	28.5	24.3	43.8	6.2
Beryllium	1.3	0.12 U	0.13 U	0.81	0.26 U	0.07 U
Cadmium	0.08 U	0.28 U	8.7	0.86 U	0.25 U	0.83 U
Calcium	4150 J	1150 J	13600 J	3530 J	5710 J	995
Chromium	16.9	7.3	23.3	12.2	9.1	4.6 U
Cobalt	6.3	1.4 U	1.5 U	3.2 U	2.9 U	0.25 U
Copper	5.4	3.2	17.7	45.1	9.9	7.4
Iron	3140	4120	4040	8530	3730	2720
Lead	28.5	17.9 J	148	86.7	23.4	36.3
Magnesium	583	151	487	1230 B	1240	464
Manganese	8	4.7	12.4	35.4	47.5	16.6
Mercury	0.4 R	0.27 R	0.35 R	1.1 R	1.1 R	0.1 U
Nickel	21.4	1.4 U	3.1	77.1	8.5	2.2
Potassium	1010	302 U	325 U	707 U	839	193
Sodium	487	293 U	316 U	985	1130	665
Thallium	0.42	0.19	0.2	0.32	0.26 U	0.34 U
Vanadium	56.8	19	10.8	314	17.7	12.1
Zinc	28 R	21.7 R	140	142 R	53.6 R	34.6 J

MG/KG - milligram per kilogram
 B - reported value is less than Contract Required Detection Limit (CRDL),
 but greater than Instrument Detection Limit (IDL)
 J - value is estimated
 R - rejected
 U - not detected

TABLE4-15
 SEDIMENT - POSITIVE DETECTION SUMMARY
 SITE 36 CAMP GEIGER AREA DUMP
 REMEDIAL INVESTIGATION, CTO-0303
 MCB, CAMP LEJEUNE, NORTH CAROLINA
 TAL METALS

LOCATION	36-SD04-612	36-SD05-06	36-SD05-612	36-SD06-06	36-SD06-612	36-SD07-06
DATE SAMPLED	08/08/95	05/18/94	05/18/94	05/18/94	05/18/94	05/18/94
DEPTH	6-12"	0-6"	6-12"	0-6"	6-12"	0-6"
ANALYTES (mg/kg)						
Aluminum	9200 J	11100	17200	2150	1560	31500
Arsenic	2.2	9 R	2.8 J	0.67 J	0.7 J	2 J
Barium	24.1	25.7	31.6	3.4	2.4	60.9
Beryllium	0.16	0.53 U	0.5 U	0.13 U	0.12 U	1.1
Cadmium	1.4	0.88 U	0.2 U	0.05 U	0.04 U	0.31 U
Calcium	5140	5670 J	8340 J	301 J	212 U	17500 J
Chromium	20.3	19.4	14.6	3.1	2.4	28.6
Cobalt	1.1 U	5.8 U	5.4 U	1.4	1.4 U	8.8 U
Copper	20.2	24.4	6.8	4.4	3.4	14.4
Iron	9560	14900	15900	1860	1090	13100
Lead	131	115	15.9 R	15100	7.1	44.9
Magnesium	1370	2750	2940	305	201	3830
Manganese	49.1	36.8	62.8	5.6	4.9	29.2
Mercury	0.66	1.4 R	1.2 R	0.41 R	0.45 R	8 R
Nickel	3.6	13.6 B	7.8	2.1	2.6	10
Potassium	708	1280 U	1210 U	314 U	304 U	2610
Sodium	1360	4980	1860	548	514	4320
Thallium	0.44 U	0.89	0.59	0.13 U	0.12 U	0.96
Vanadium	25.1	39.3	19.6	4.6	3.2	28.6
Zinc	116 J	145 R	32.9 R	25.9 R	16.6 R	50.9 R

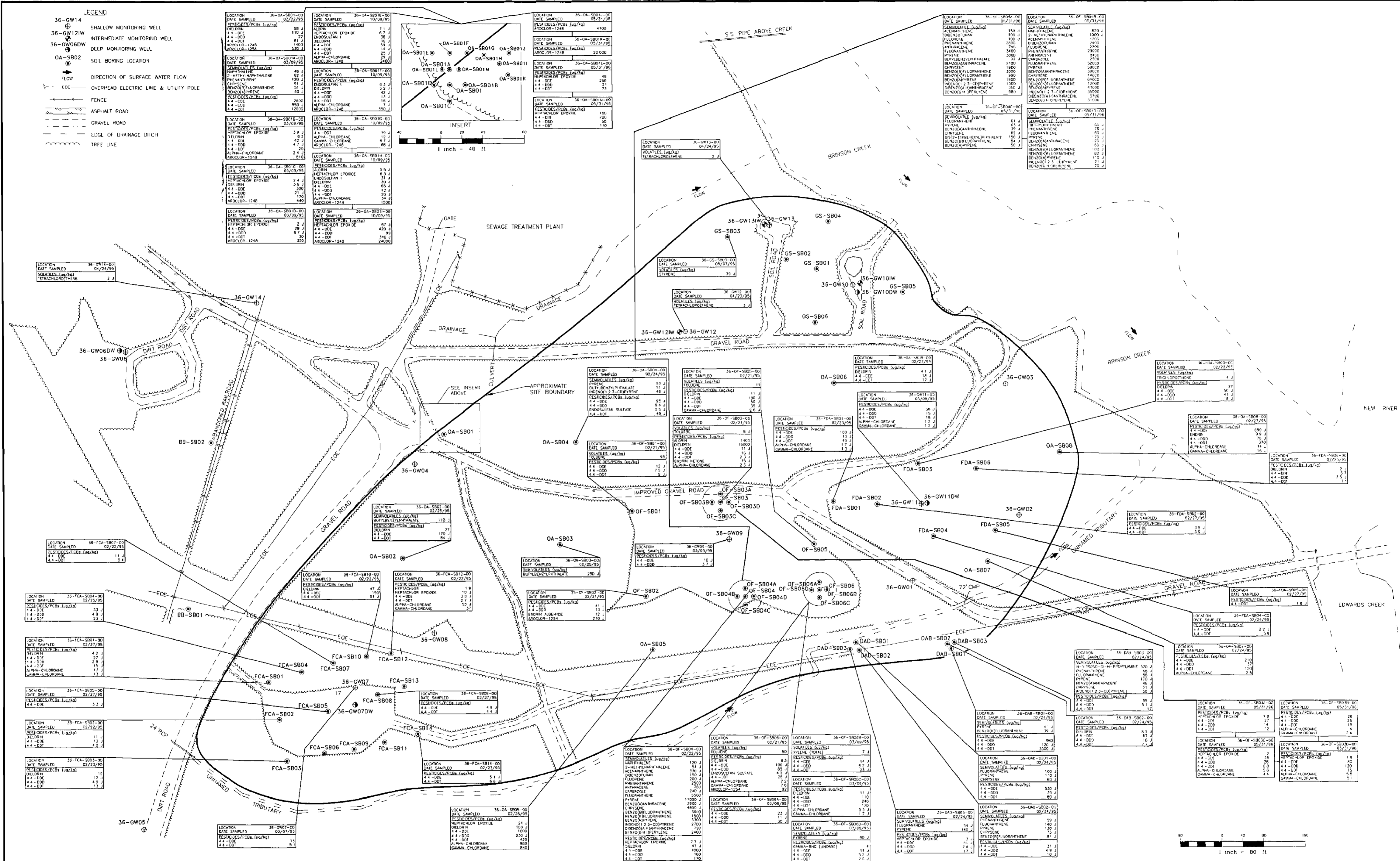
MG/KG - milligram per kilogram
 B - reported value is less than Contract Required Detection Limit (CRDL),
 but greater than Instrument Detection Limit (IDL)
 J - value is estimated
 R - rejected
 U - not detected

TABLE4-15
 SEDIMENT - POSITIVE DETECTION SUMMARY
 SITE 36 CAMP GEIGER AREA DUMP
 REMEDIAL INVESTIGATION, CTO-0303
 MCB, CAMP LEJEUNE, NORTH CAROLINA
 TAL METALS

LOCATION	36-SD07-612
DATE SAMPLED	05/18/94
DEPTH	6-12"
ANALYTES (mg/kg)	
Aluminum	10800
Arsenic	1.7 J
Barium	19.9
Beryllium	0.45 U
Cadmium	0.49 U
Calcium	8610 J
Chromium	10.4
Cobalt	4.9 U
Copper	5.1
Iron	9710
Lead	17
Magnesium	1830
Manganese	15.3
Mercury	3.9 R
Nickel	7.3
Potassium	1090 U
Sodium	1180
Thallium	0.54
Vanadium	12.4
Zinc	29.2 R

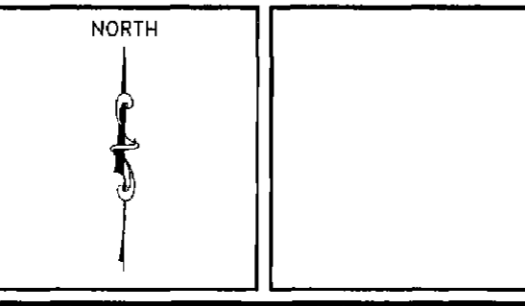
MG/KG - milligram per kilogram
 B - reported value is less than Contract Required Detection Limit (CRDL),
 but greater than Instrument Detection Limit (IDL)
 J - value is estimated
 R - rejected
 U - not detected

SECTION 4.0 FIGURES



REVISIONS	

DRAWN	REL
REVIEWED	11T/JEZ
S O #	62470-303
CADD#	303079R1



REMEDIAL INVESTIGATION, CTO-0303
 MARINE CORPS BASE, CAMP LEJEUNE
 NORTH CAROLINA

BAKER ENVIRONMENTAL, Inc.
 Coraopolis, Pennsylvania

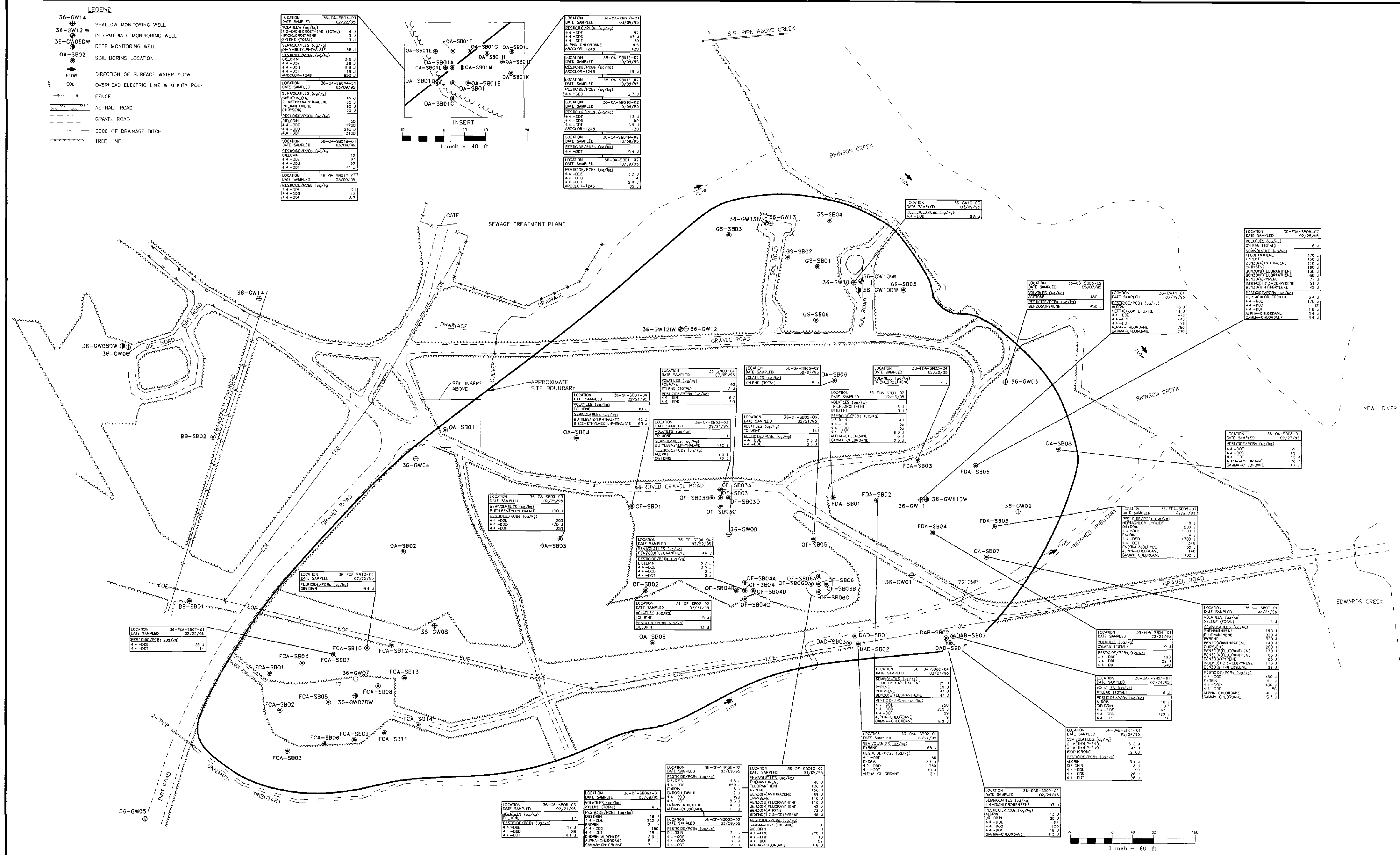


ORGANIC COMPOUNDS IN
SURFACE SOILS
SITE 36, CAMP GEIGER AREA DUMP

SCALE 1" = 80'
 DATE JANUARY 1995

FIGURE No.
4-1

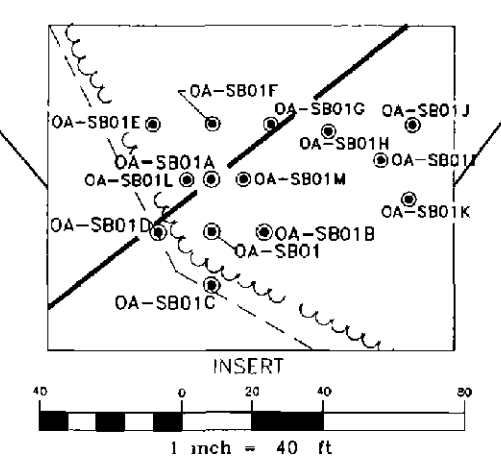
01710V.B6X



LEGEND

- 36-GW14 SHALLOW MONITORING WELL
- 36-GW12W INTERMEDIATE MONITORING WELL
- 36-GW06DW DFFP MONITORING WELL
- OA-SB02 SOIL BORING LOCATION
- FLOW DIRECTION OF SURFACE WATER FLOW
- EOE OVERHEAD ELECTRIC LINE & UTILITY POLE
- FENCE
- ASPHALT ROAD
- GRAVEL ROAD
- EDGE OF DRAINAGE DITCH
- TREE LINE

LOCATION	36-0A-SB01-01
DATE SAMPLED	02/22/95
VOLATILES (ug/g)	4 J
1,2-DICHLOROBENZENE (TOTAL)	2 J
TRICHLOROETHENE	1 J
XYLENE (TOTAL)	3 J
SEMIVOLATILES (ug/g)	56 J
1,1-DICHLOROETHENE	3.5 J
1,1-DICHLOROETHANE	3.8 J
1,1-DICHLOROETHANE	8.9 J
1,1-DICHLOROETHANE	18 J
1,1-DICHLOROETHANE	390 J



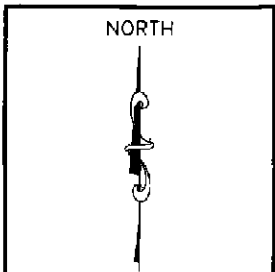
LOCATION	36-0A-SB01B-01
DATE SAMPLED	03/09/95
VOLATILES (ug/g)	92
1,2-DICHLOROBENZENE (TOTAL)	47.3
TRICHLOROETHENE	2.8
XYLENE (TOTAL)	30
SEMIVOLATILES (ug/g)	4.5
1,1-DICHLOROETHENE	4.2

LOCATION	36-0A-SB01A-01
DATE SAMPLED	03/09/95
VOLATILES (ug/g)	180
1,2-DICHLOROBENZENE (TOTAL)	100
TRICHLOROETHENE	19.3
XYLENE (TOTAL)	3.9 J
SEMIVOLATILES (ug/g)	170
1,1-DICHLOROETHENE	11.3
1,1-DICHLOROETHANE	180
1,1-DICHLOROETHANE	3.9 J
1,1-DICHLOROETHANE	4.5
1,1-DICHLOROETHANE	4.5

REVISIONS

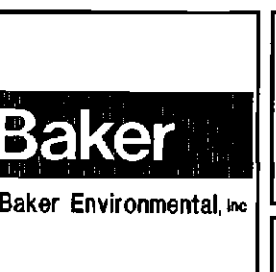
DATE	02/22/95
BY	36 J
DESCRIPTION	4 - DDE
4 - DDT	14

DRAWN	REL
REVIEWED	TFT
S O #	62470-303
CADD#	303078RI



REMEDIAL INVESTIGATION, CTO-0303
MARINE CORPS BASE, CAMP LEJEUNE
NORTH CAROLINA

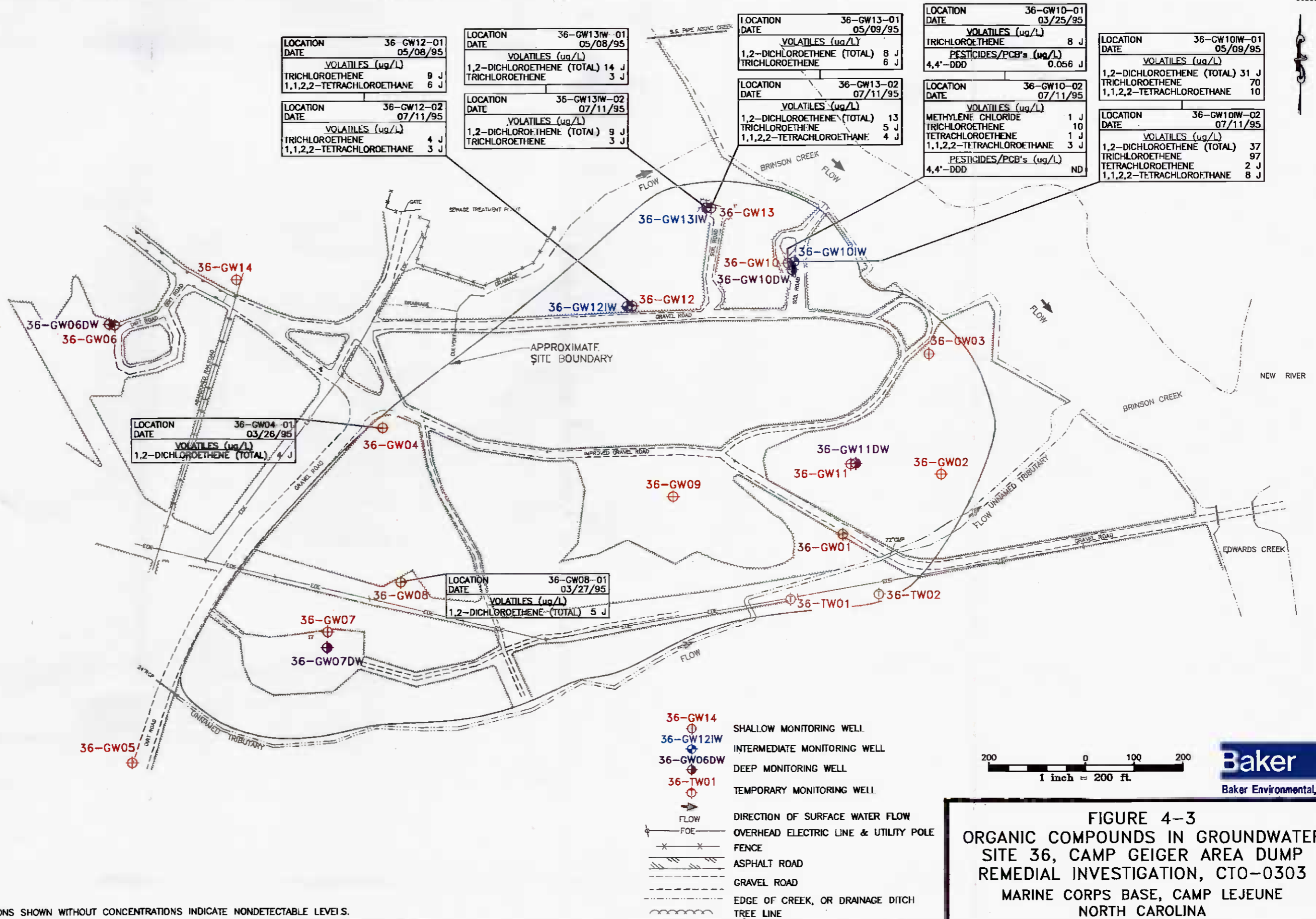
Baker Environmental, Inc.
Coraopolis, Pennsylvania



ORGANIC COMPOUNDS IN
SUBSURFACE SOILS
SITE 36, CAMP GEIGER AREA DUMP

SCALE 1" = 80'
DATE JANUARY 1995

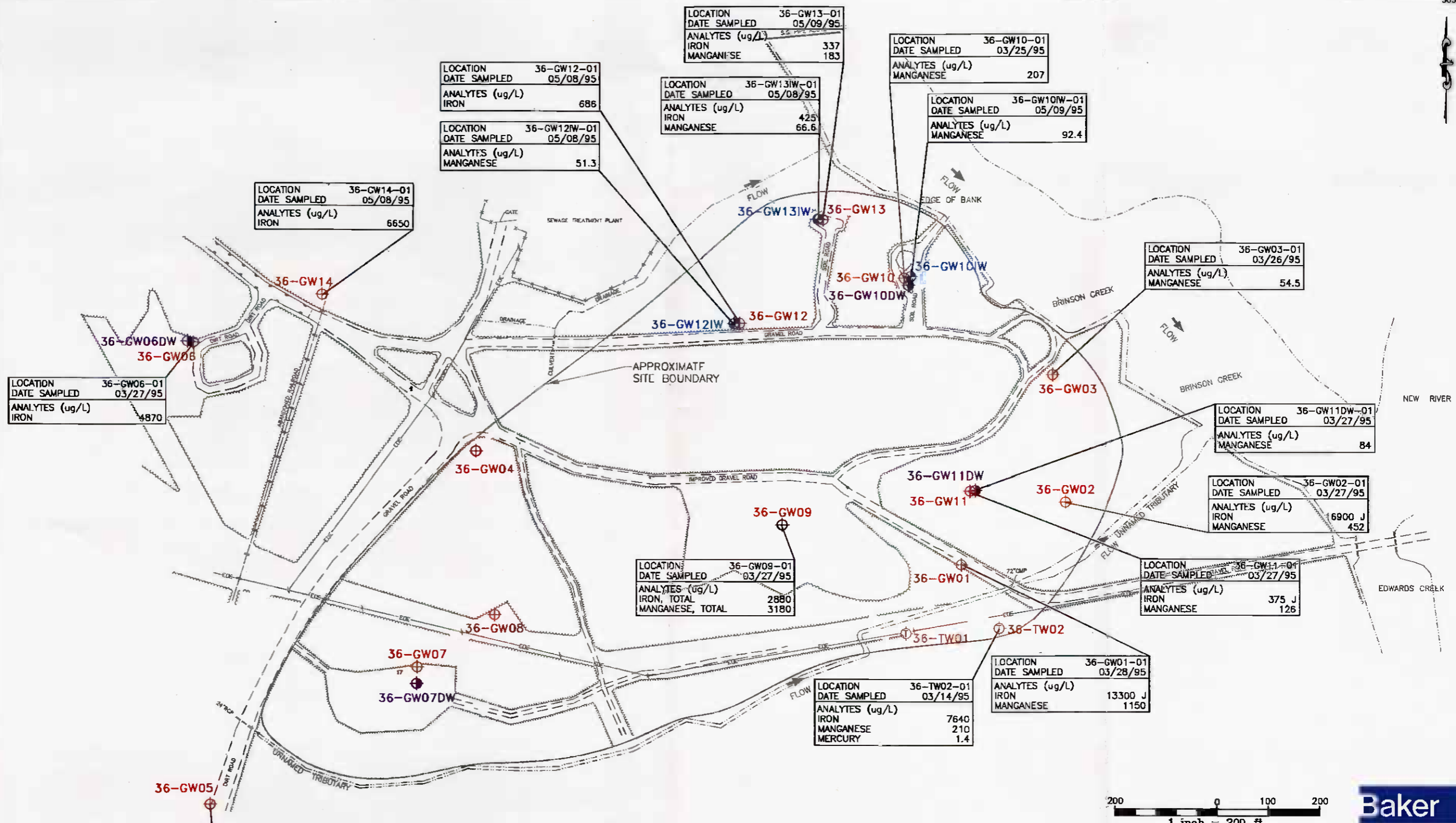
FIGURE No
4-2



NOTE: LOCATIONS SHOWN WITHOUT CONCENTRATIONS INDICATE NONDETECTABLE LEVELS.

FIGURE 4-3
ORGANIC COMPOUNDS IN GROUNDWATER
SITE 36, CAMP GEIGER AREA DUMP
REMEDIAL INVESTIGATION, CTO-0303
MARINE CORPS BASE, CAMP LEJEUNE
NORTH CAROLINA

01710YB7Y



LEGEND

- 36-GW14 SHALLOW MONITORING WELL
- 36-GW12W INTERMEDIATE MONITORING WELL
- 36-GW06DW DEEP MONITORING WELL
- 36-TW01 TEMPORARY MONITORING WELL

- FLOW DIRECTION OF SURFACE WATER FLOW
- FOE OVERHEAD ELECTRIC LINE & UTILITY POLE
- FENCE
- ASPHALT ROAD
- GRAVEL ROAD
- EDGE OF CREEK, OR DRAINAGE DITCH
- TREE LINE

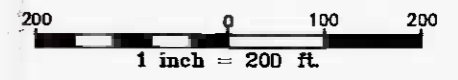
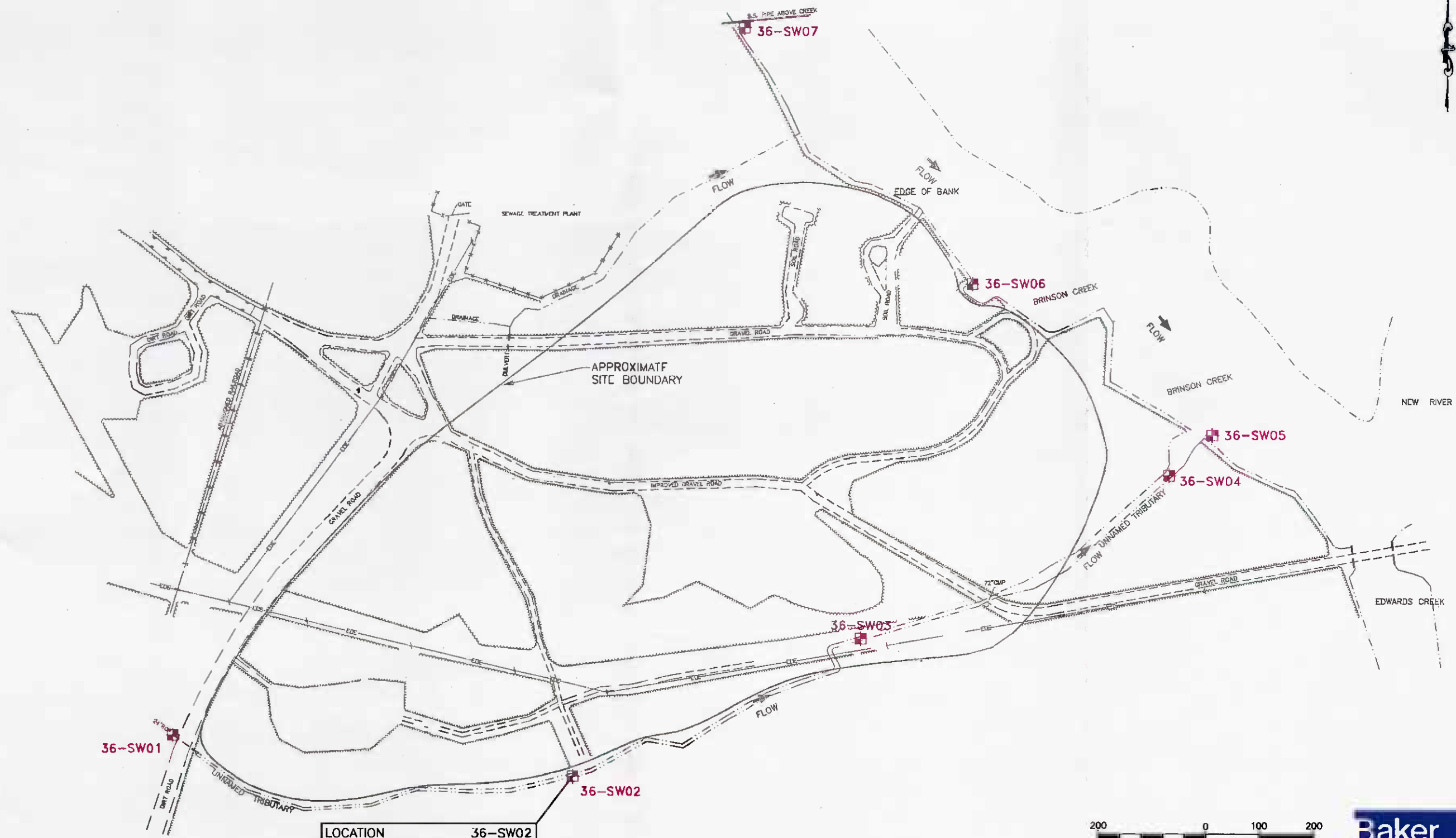


FIGURE 4-4
TAL METALS IN GROUNDWATER
ABOVE SCREENING STANDARDS
SITE 36, CAMP GEIGER AREA DUMP
REMEDIAL INVESTIGATION, CTO-0303
MARINE CORPS BASE, CAMP LEJEUNE
NORTH CAROLINA



LOCATION	36-SW02
VOLATILES (ug/l)	
1,2-Dichloroethene (total)	7

- 36-SW01 SURFACE WATER SAMPLE LOCATION
- FLOW DIRECTION OF SURFACE WATER FLOW
- FOE— OVERHEAD ELECTRIC LINE & UTILITY POLE
- X—X— FENCE
- ==== ASPHALT ROAD
- GRAVEL ROAD
- - - - - EDGE OF CREEK, OR DRAINAGE DITCH
- ~~~~~ TREE LINE

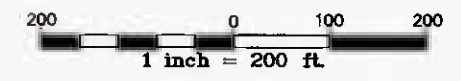


FIGURE 4-5
ORGANIC COMPOUNDS IN SURFACE WATER
SITE 36, CAMP GEIGER AREA DUMP
REMEDIAL INVESTIGATION, CTO-0303
MARINE CORPS BASE, CAMP LEJEUNE
NORTH CAROLINA

NOTE: LOCATIONS SHOWN WITHOUT CONCENTRATIONS INDICATE NONDETECTABLE LEVELS.

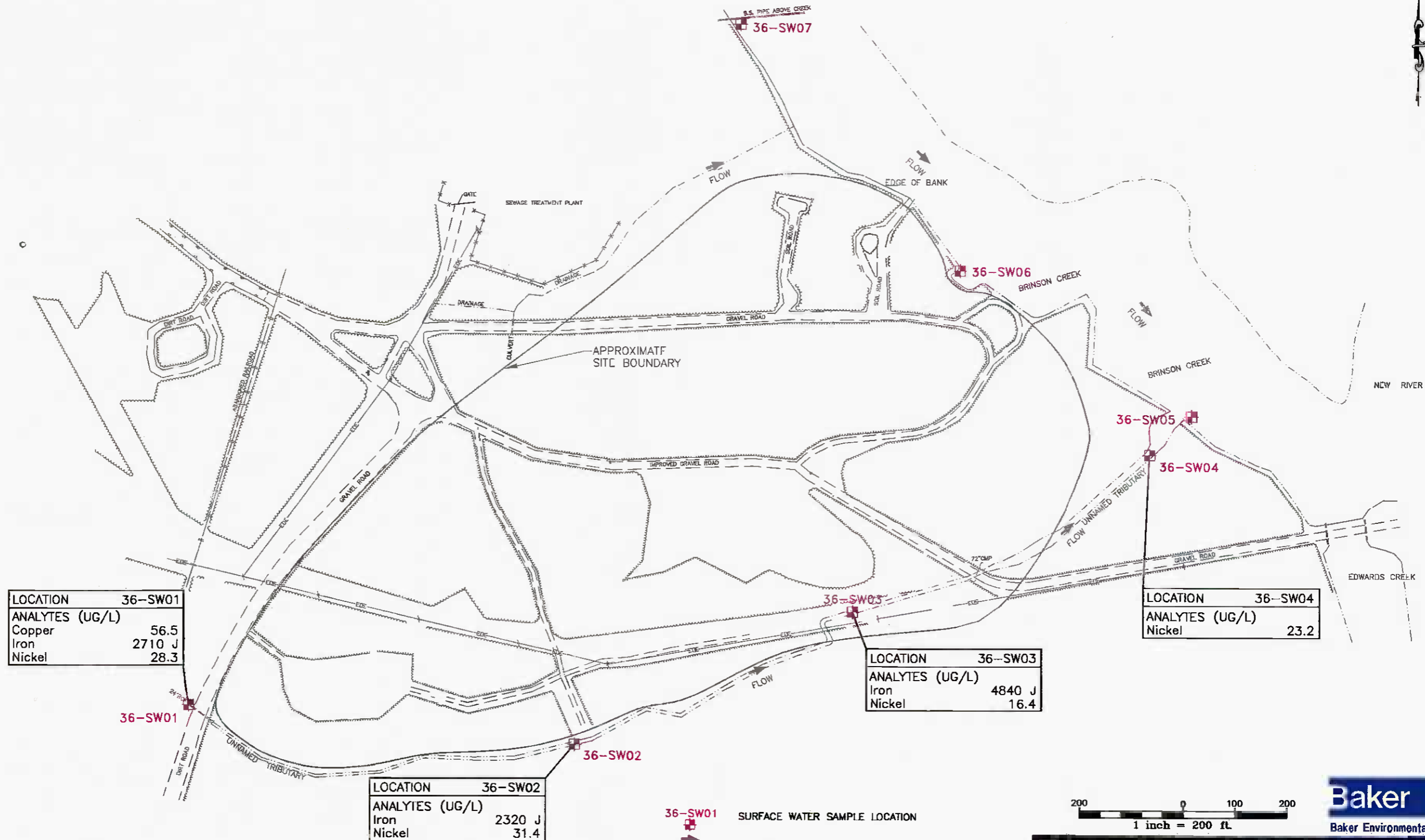
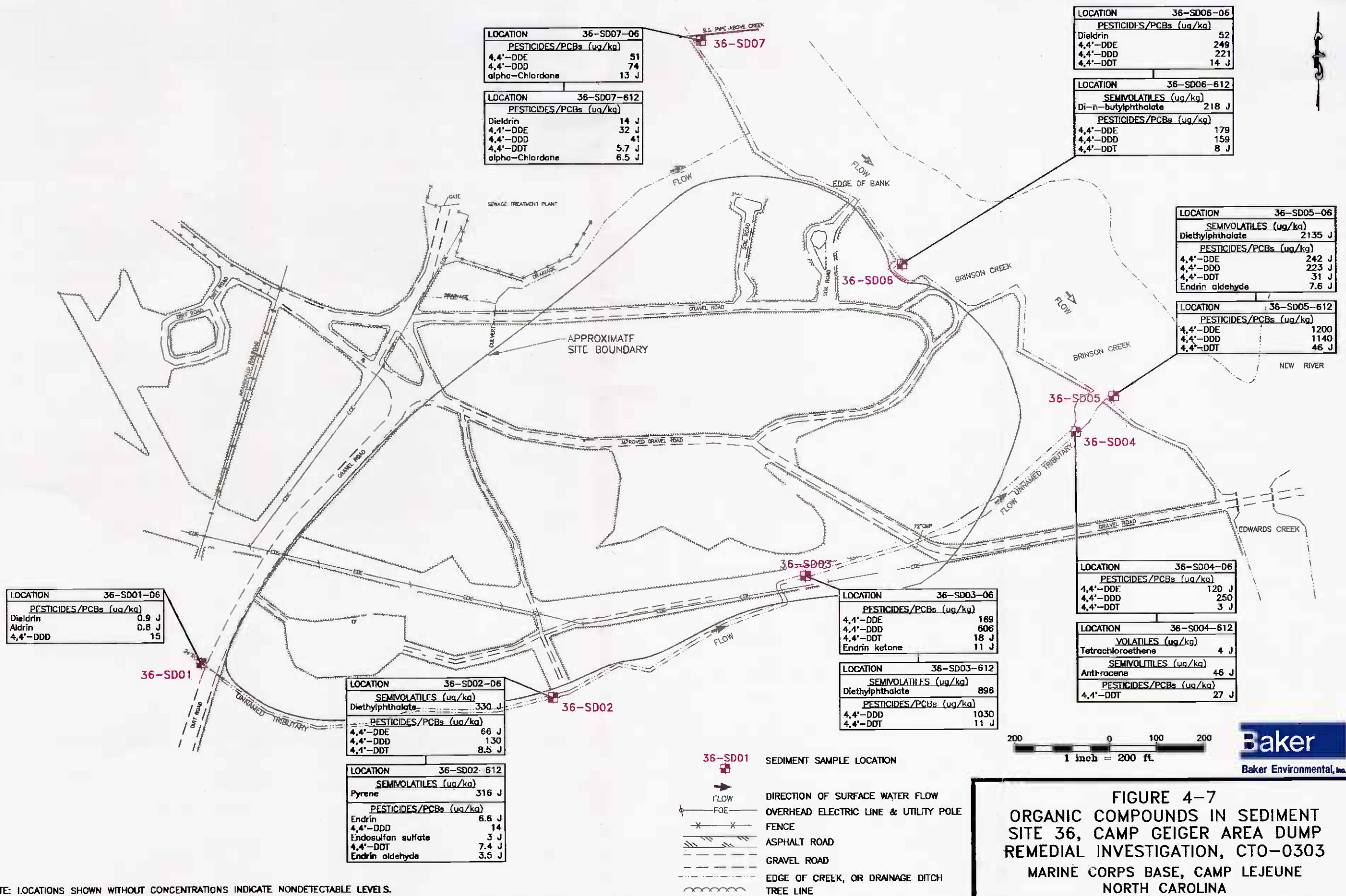


FIGURE 4-6
TAL METALS IN SURFACE WATER
ABOVE SCREENING VALUES
SITE 36, CAMP GEIGER AREA DUMP
REMEDIAL INVESTIGATION, CTO-0303
MARINE CORPS BASE, CAMP LEJEUNE
NORTH CAROLINA





LOCATION	36-SD07-06
PESTICIDES/PCBs (ug/kg)	
4,4'-DDE	51
4,4'-DDD	74
alpha-Chlordane	13 J

LOCATION	36-SD07-612
PESTICIDES/PCBs (ug/kg)	
Dieldrin	14 J
4,4'-DDE	32 J
4,4'-DDD	41
4,4'-DDT	5.7 J
alpha-Chlordane	6.5 J

LOCATION	36-SD06-06
PESTICIDES/PCBs (ug/kg)	
Dieldrin	52
4,4'-DDE	249
4,4'-DDD	221
4,4'-DDT	14 J

LOCATION	36-SD06-612
SEMIVOLATILES (ug/kg)	
Di-n-butylphthalate	218 J
PESTICIDES/PCBs (ug/kg)	
4,4'-DDE	179
4,4'-DDD	159
4,4'-DDT	8 J

LOCATION	36-SD05-06
SEMIVOLATILES (ug/kg)	
Diethylphthalate	2135 J
PESTICIDES/PCBs (ug/kg)	
4,4'-DDE	242 J
4,4'-DDD	223 J
4,4'-DDT	31 J
Endrin aldehyde	7.6 J

LOCATION	36-SD05-612
PESTICIDES/PCBs (ug/kg)	
4,4'-DDE	1200
4,4'-DDD	1140
4,4'-DDT	46 J

LOCATION	36-SD01-06
PESTICIDES/PCBs (ug/kg)	
Dieldrin	0.9 J
Aldrin	0.8 J
4,4'-DDD	15

LOCATION	36-SD02-06
SEMIVOLATILES (ug/kg)	
Diethylphthalate	330 J
PESTICIDES/PCBs (ug/kg)	
4,4'-DDE	66 J
4,4'-DDD	130
4,4'-DDT	8.5 J

LOCATION	36-SD02-612
SEMIVOLATILES (ug/kg)	
Pyrene	316 J
PESTICIDES/PCBs (ug/kg)	
Endrin	6.6 J
4,4'-DDD	14
Endosulfan sulfate	3 J
4,4'-DDT	7.4 J
Endrin aldehyde	3.5 J

LOCATION	36-SD03-06
PESTICIDES/PCBs (ug/kg)	
4,4'-DDE	169
4,4'-DDD	606
4,4'-DDT	18 J
Endrin ketone	11 J

LOCATION	36-SD03-612
SEMIVOLATILES (ug/kg)	
Diethylphthalate	896
PESTICIDES/PCBs (ug/kg)	
4,4'-DDD	1030
4,4'-DDT	11 J

LOCATION	36-SD04-06
PESTICIDES/PCBs (ug/kg)	
4,4'-DDE	120 J
4,4'-DDD	250
4,4'-DDT	3 J

LOCATION	36-SD04-612
VOLATILES (ug/kg)	
Tetrachloroethene	4 J
SEMIVOLATILES (ug/kg)	
Anthracene	46 J
PESTICIDES/PCBs (ug/kg)	
4,4'-DDT	27 J

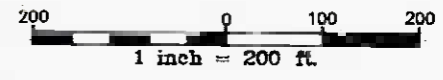
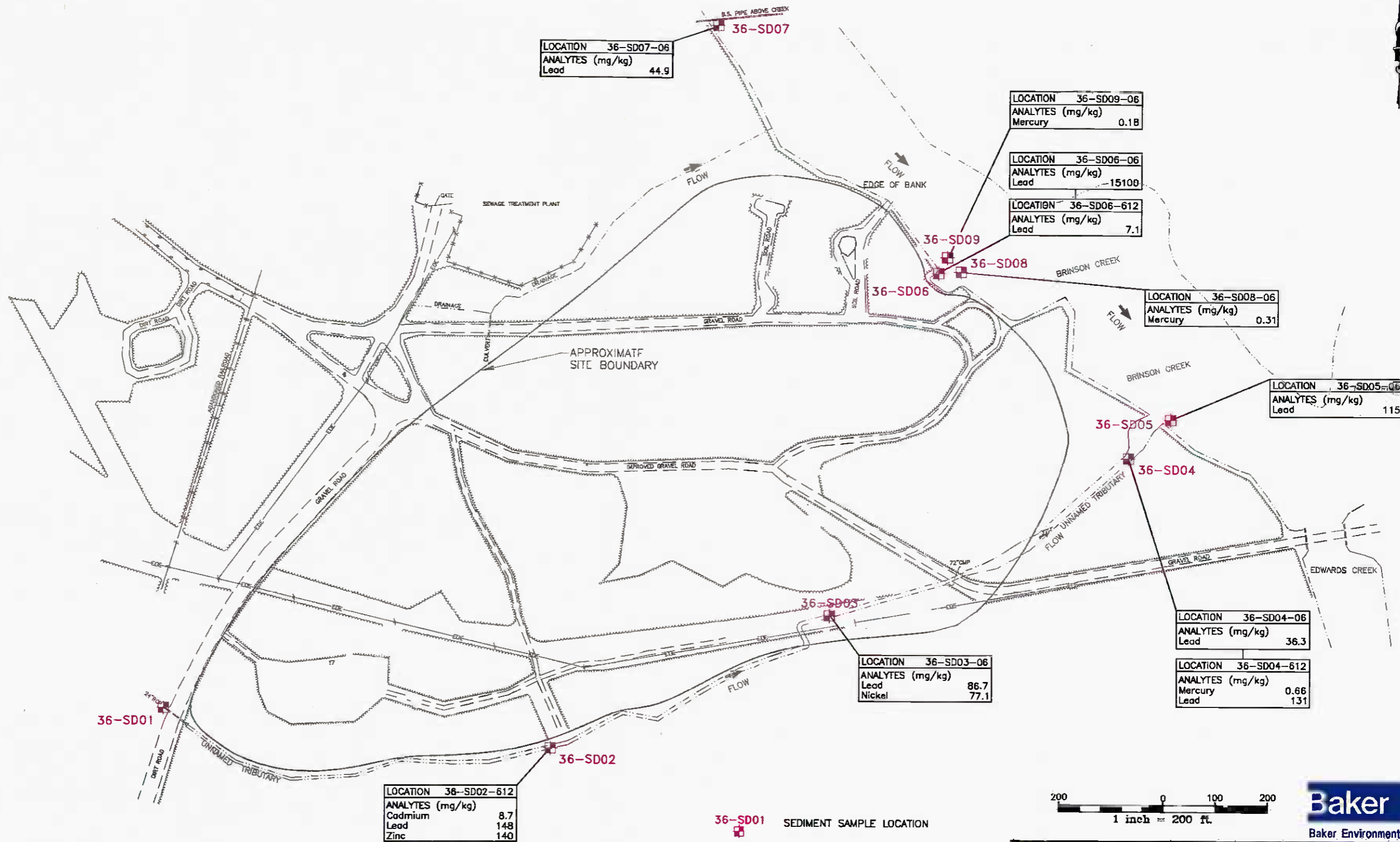
- 36-SD01 SEDIMENT SAMPLE LOCATION
- FLOW DIRECTION OF SURFACE WATER FLOW
- FOE OVERHEAD ELECTRIC LINE & UTILITY POLE
- X X FENCE
- ASPHALT ROAD
- GRAVEL ROAD
- EDGE OF CREEK, OR DRAINAGE DITCH
- TREE LINE

200 0 100 200
1 inch = 200 ft.



FIGURE 4-7
ORGANIC COMPOUNDS IN SEDIMENT
SITE 36, CAMP GEIGER AREA DUMP
REMEDIAL INVESTIGATION, CTO-0303
MARINE CORPS BASE, CAMP LEJEUNE
NORTH CAROLINA

NOTE: LOCATIONS SHOWN WITHOUT CONCENTRATIONS INDICATE NONDETECTABLE LEVELS.



- 36-SD01** SEDIMENT SAMPLE LOCATION
- FLOW DIRECTION OF SURFACE WATER FLOW
- FOE OVERHEAD ELECTRIC LINE & UTILITY POLE
- FENCE
- ASPHALT ROAD
- GRAVEL ROAD
- EDGE OF CREEK, OR DRAINAGE DITCH
- TREE LINE

FIGURE 4-8
TAL METALS IN SEDIMENT
ABOVE SCREENING VALUES
SITE 36, CAMP GEIGER AREA DUMP
REMEDIAL INVESTIGATION, CTO-0303
MARINE CORPS BASE, CAMP LEJEUNE
NORTH CAROLINA

5.0 CONTAMINANT FATE AND TRANSPORT

The potential for a contaminant to migrate and persist in an environmental medium is critical when evaluating the potential for a chemical to elicit an adverse human health or ecological effect. The environmental mobility of a chemical is influenced by its physical and chemical properties, the physical characteristics of the site, and the site chemistry. This section presents a discussion of the various physical and chemical properties of significant contaminants in Site 36 media discussed in Section 4.0, and their fate and transport in the environment.

5.1 Chemical and Physical Properties Impacting Fate and Transport

Table 5-1 presents the physical and chemical properties associated with the organic compounds detected during this investigation. These properties determine the inherent environmental mobility and fate of a contaminant. The properties of interest include:

- Vapor pressure
- Water solubility
- Octanol/water partition coefficient
- Organic carbon adsorption coefficient (sediment partition)
- Specific gravity
- Henry's Law constant

A discussion of the environmental significance of each of these properties follows.

Vapor pressure provides an indication of the rate at which a chemical may volatilize. It is of primary significance at environmental interfaces such as surface soil/air and surface water/air. Volatilization can be important when evaluating groundwater and subsurface soils, particularly when selecting remedial technologies. Vapor pressure for monocyclic aromatics is generally higher than vapor pressures for PAHs. Contaminants with higher vapor pressures (e.g., VOCs) will enter the atmosphere at a quicker rate than the contaminants with low vapor pressures (e.g., PCBs).

The rate at which a contaminant is leached from soil by infiltrating precipitation is proportional to its water solubility. More soluble contaminants are usually more readily leached than less soluble contaminants. The water solubilities indicate that the volatile organic contaminants, including monocyclic aromatics, are usually several orders-of-magnitude more soluble than PAHs. Consequently, highly soluble compounds such as the chlorinated VOCs will go into solution faster and possibly in greater concentrations than less soluble compounds. The solubility of a specific compound is dependent on the chemistry of the groundwater and aquifer material. Factors such as groundwater pH, Eh (redox potential), temperature, and the presence of other compounds can greatly affect the solubility.

The octanol/water partition coefficient (K_{ow}) is the ratio of the chemical concentration in octanol divided by the concentration in water. The octanol/water partition coefficient has been shown to correlate well with bioconcentration factors in aquatic organisms and adsorption to soil or sediment. Specifically, a linear relationship between octanol/water partition coefficients and the uptake of chemicals by fatty tissues of animal and human receptors (the bioconcentration factor - BCF) has been established (Lyman et al., 1982). The coefficient is also useful in characterizing the sorption of compounds by organic soils where experimental values are not available.

The organic carbon adsorption coefficient (K_{oc}) indicates the tendency of a chemical to adhere to the organic carbon in soil particles. The solubility of a chemical in water is inversely proportional to the K_{oc} . Contaminants with high soil/sediment adsorption coefficients generally have low water solubilities. For example, contaminants such as PAHs are relatively immobile in the environment, are preferentially bound to the soil, and have a higher K_{oc} value. These compounds are not subject to aqueous transport to the extent of compounds with higher water solubilities. Mechanical activities (e.g., erosion) and the physical characteristics of surface soils may, however, increase the mobility of these bound soil contaminants.

Specific gravity is the ratio of a given volume of pure chemical at a specified temperature to the weight of the same volume of water at a specified temperature. Its primary use is to determine whether a contaminant will have a tendency to "float" or "sink" (as an immiscible liquid) in water if it exceeds its corresponding water solubility.

Vapor pressure and water solubility are of use in determining volatilization rates from surface water bodies and from groundwater. These two parameters can be used to estimate an equilibrium concentration of a contaminant in the water phase and in the air directly above the water. This relationship is expressed as Henry's Law Constant.

A quantitative assessment of mobility has been developed that uses water solubility (S), vapor pressure (VP), and organic carbon partition coefficient (K_{oc}) (Laskowski, 1983). This value is referred to as the Mobility Index (MI). It is defined as:

$$MI = \log((S*VP)/K_{oc})$$

A scale to evaluate MI as presented by Ford and Gurba (1984) is:

<u>Relative MI</u>	<u>Mobility Description</u>
> 5	extremely mobile
0 to 5	very mobile
-5 to 0	slightly mobile
-10 to -5	immobile
< -10	very immobile

The mobility index for each organic analyte detected at Site 36 is presented on Table 5-1.

5.2 Contaminant Transport Pathways

Based on the evaluation of existing conditions at Site 36, the following potential contaminant transport pathways have been identified.

- Windblown dust/Volatilization
- Leaching of sediment contaminants to surface water
- Leaching of soil contaminants to groundwater
- Migration of groundwater contaminants, both laterally and vertically, including infiltration from the shallow aquifer to the deep aquifer

Contaminant concentrations may be affected by one or more mechanisms during transport. Contaminants may be physically transformed by volatilization or precipitation. Contaminants may be chemically transformed through photolysis, hydrolysis, oxidation/reduction. Contaminants may be biologically transformed by biodegradation. Additionally, contaminants may accumulate in one or more media. Since different transformation mechanisms are important for different contaminants, mechanisms are discussed as necessary in Section 5.3.

The paragraphs which follow describe the potential transport pathways listed above with respect to significant compound concentrations. Significant compound concentrations refers to those compounds discussed in Section 4.0 frequently occurring above criteria comparisons. Specific fate and transport concerns are discussed in Section 5.3.

5.2.1 Windblown Dust/Volatilization

PAHs, pesticides, volatiles, and metals were observed in surface soil samples at a few, scattered locations at Site 36 (Figures 4-1 and 4-4). Wind serves as a contaminant transport pathway agent by eroding exposed soil and sediment and blowing it off site. This process is influenced by wind velocity, the grain size/density of the soil/sediment particles, moisture conditions, and the amount of vegetative cover over the soil or sediment. Organic compounds with high K_{oc} values adsorb to organic matter in the soil. Inorganic compounds tend to adsorb to the clay minerals in the soil.

A majority of the surface area of Site 36 is vegetated. This vegetation minimizes the likelihood of fugitive dust generation.

Contaminants in surface soils with high vapor pressures (i.e., VOCs) may gas-off to the atmosphere. This process may be enhanced by erosional disturbances of surface soils. Again, a majority of the surface area of Site 36 is vegetated. Additionally, concentrations of VOCs in surface soils were found to be low: less than 10 ppb. This suggests that volatilization of contaminants to the atmosphere is insignificant at Site 36.

5.2.2 Leaching of Sediment Contaminants to Surface Water

There are two bodies of concern at Site 36, Brinson Creek and an unnamed tributary to the creek. Pesticides were detected in most sediment samples from both creeks (Figure 4-7). Several heavy metals were detected in a few, scattered sediment samples from both creeks. (A heavy metal refers to a metal having an atomic weight greater than that of sodium.) The surface water does not appear to be impacted, and is discussed further in Section 4.3.

When in contact with surface water, contaminants attached to sediment particles can disassociate from the sediment particle into surface water. This is primarily influenced by the physical and chemical properties of the contaminant (i.e., water solubility, K_{oc}) and the physical and chemical properties of the sediment particle (i.e., grain size, fraction of organic content).

5.2.3 Leaching of Soil Contaminants to Groundwater

Volatile organics, PAHs, PCBs, pesticides and metals have been detected in soils a few, scattered locations at Site 36. Volatile organics were detected in groundwater, primarily in the northeast portion of the site. Iron and manganese were detected in groundwater in most wells at the site, but may be naturally-occurring, as described in Section 5.3.4. A comparison of compounds and relative

concentrations is discussed in Section 5.3, and provides a qualitative assessment of contaminant leaching.

Contaminants that adhere to soil particles or have accumulated in soil pore spaces can leach and migrate vertically to the groundwater as a result of infiltration of precipitation. The rate and extent of this leaching is influenced by the depth to the water table, amount of precipitation, rate of infiltration, the physical and chemical properties of the soil, and the physical and chemical properties of the contaminant.

5.2.4 Migration of Groundwater Contaminants

Organics and inorganics leaching from soil into groundwater can migrate as dissolved constituents in groundwater in the direction of groundwater flow. Three general processes govern the migration of dissolved constituents in groundwater: advection, dispersion, and retardation. Advection is a process by which solutes are carried by groundwater movement. Dispersion is a mixing of contaminated and uncontaminated water during advection. Retardation is a slowing of contaminant migration caused by the reaction of the solute with the aquifer soil.

A contaminant that is present in water above its solubility concentration will form an immiscible liquid. Based on the specific gravity of the contaminant, it will either float or sink in the water. Subsurface transport of the immiscible contaminants is governed by a set of factors different from those of dissolved contaminants.

Movement of immiscible is controlled by entry conditions and flow conditions (Feenstra, et al., 1995). Entry of an immiscible liquid to a subsurface system is primarily controlled by the capillary phenomena. These phenomena arise from the fact that an interfacial tension is present between two mutually immiscible liquids (contaminant and water, or contaminant and air) in small pore space. Once in a subsurface system, the rate and direction of flow depends on the density and viscosity of the fluid, the pressure driving the fluid, the hydraulic conductivity of the formation, and the degree of saturation of the fluid in the formation (Feenstra, et al., 1995). Fluids denser than water will sink, fluids lighter than water will float. The driving pressure is related to the amount of fluid released into the environment. An immiscible liquid will flow faster where the fluid is already present in the formation. Contaminants from the immiscible liquids may then dissolve into groundwater, volatilize from groundwater to ground air, evaporate directly into ground air, or sorb from groundwater to solid surfaces.

Advection is the process by which moving groundwater carries dissolved solutes (Fetter, 1988). Groundwater flow velocities at Site 36 were determined by using a variation of Darcy's equation, as discussed in Section 2.5.4. Groundwater flow velocities in the surficial and Castle Hayne aquifers underlying Site 36 range from 0.02 to 0.08 feet/day, or 7.3 to 29.2 feet/year. Groundwater in the surficial aquifer flows from the west to the east and northeast, discharging to Brinson Creek. Groundwater in the Castle Hayne flows to the northeast, and likely discharges to the New River according to data compiled by Cardinell, et al. (Cardinell et al., 1993).

The surficial and Castle Hayne aquifers underlying Site 36 are separated by the Castle Hayne confining unit. This confining unit consists predominantly of silty fine sand and is 17 to 23 feet thick. Although the confining unit exists, there appears to be a potential for vertical groundwater movement between aquifers.

Vertical groundwater flow gradients through the Castle Hayne confining unit at Site 36 vary by nearly three orders of magnitude (Appendix O). Well clusters 36-GW07 and 36-GW11 exhibit very small vertical flow gradients (0.009 and 0.0005 feet/foot, respectively) and varying flow direction. Vertical advection through the semiconfining unit in these locations would be expected to be insignificant. Well cluster 36-GW06 exhibited a consistent downward component of flow. The gradient was calculated to be 0.18 feet/foot. Well cluster 36-GW10 exhibited a consistent upward component of flow. The gradient was calculated to be 0.03 feet/foot. Both gradients suggest that vertical advection through the confining unit is likely.

Data obtained from a pump test performed within Hadnot Point (ESE, 1988) indicate a vertical hydraulic conductivity (or leakage characteristic) averaging 0.018 feet/day (6.3×10^{-6} cm/sec) for the confining unit. Laboratory hydraulic conductivities were determined for samples of the confining unit at other sites in OU No. 6 and were found to be 0.0004 feet/day (1.4×10^{-7} cm/sec) at Site 43 and 0.04 feet/day (1.3×10^{-5} cm/sec) at Site 44. These data are similar and indicate that the confining unit is more likely to be semiconfining.

Despite the indication that the Castle Hayne confining unit is only semi-confining, evidence of organic compound migration between the two aquifers has not been found. At cluster 36-GW10 where organic groundwater contamination was observed, an upward flow potential through the semiconfining unit was observed. As noted in this report, metals (i.e., manganese) have been detected in the Castle Hayne aquifer at Site 36.

Dispersion results from two basic processes; molecular diffusion and mechanical mixing. The kinetic activity of dissolved solutes results in diffusion of solutes from a zone of high concentration to a zone of lower concentration. Dispersion can occur in three directions, longitudinal (in the direction of flow), transverse (horizontally perpendicular to longitudinal), and vertical. Dispersion is largely scale dependent (i.e., the greater the area over which it is measured, the larger the dispersion value). Furthermore, longitudinal dispersion is often observed to be markedly greater than dispersion in the transverse direction of flow. It is often assumed that transverse dispersion is one-tenth longitudinal dispersion (Nichols, 1993). Lacking detailed site studies to determine dispersion, the parameter can be estimated to be one-tenth of the length of the flow path, in the same lithologies (Fetter, 1988).

Retardation is a process whereby a solute concentration is reduced through a chemical, biological, or radioactive change. Solute can be categorized in two broad classes: conservative and reactive. Conservative solutes do not react with aquifer groundwater and soil. Reactive solutes will interact with the aquifer soil encountered along the flow path through adsorption, partitioning, ion exchange, and other processes. The retardation factor (R) can be calculated by the following equation (Fetter, 1988):

$$R = 1 + (P_b/n)(K_d)$$

where:

- P_b = dry bulk density of the soil
- n = porosity of the soil
- k_d = distribution coefficient for the solute with the soil (K_{oc} of the solute times the TOC content of the soil)

The following is a summary of estimated retardation factors for chlorinated VOCs detected in groundwater samples at Site 36:

<u>Solute</u>	<u>Retardation Factor</u>
1,2-Dichloroethene (total)	1.70
1,1,2,2-Tetrachloroethane	2.69
Trichloroethene	2.81
Tetrachloroethene	6.22
1,1,2,2-Tetrachloroethane	2.69

Retardation factor calculations are presented in Appendix O. The lower the retardation factor, the faster the migration rate. These factors are estimated because of the lack of site-specific data including bulk density, TOC analytical data and porosity. It is common however, to estimate retardation factors. The relative differences are useful for describing plume characteristics.

Natural biodegradation of chlorinated VOCs is slow according to U.S. Department of Health and Human Services' toxicological profile manuals for these compounds. These manuals as well as other sources show that tetrachloroethane and 1,1,2,2-tetrachloroethane will degrade to trichloroethene. Trichloroethene will degrade primarily to 1,2-dichloroethene (cis), and to a lesser extent, 1,2-dichloroethene (trans). 1,2-Dichloroethene (cis) will degrade to chloroethane and, to a lesser extent, vinyl chloride. 1,2-Dichloroethene (trans) will degrade to vinyl chloride.

1,2-Dichloroethene(total), trichloroethene, and tetrachloroethene have been detected in groundwater samples. Both trichloroethene and tetrachloroethene are common solvents. Eighty percent of trichloroethene used in the U.S. is for metal parts cleaning (U.S. Dept. of HH&S, 1991), while 50 percent of tetrachloroethene is used for dry cleaning (U.S. Dept. of HH&S, 1990). 1,2-Dichloroethene (cis & trans) is primarily used as a chemical intermediate in production of chlorinated solvents and compounds (U.S. Dept. of HH&S, 1994). It is possible that trichloroethene and tetrachloroethene were used at Camp Lejeune, rather than 1,2-dichloroethene. Therefore, the 1,2-dichloroethene detected in groundwater samples is likely a transformation product rather than a primary contaminant.

Metals are inherent to soil and sediment, and groundwater. For this reason, concentrations of metals must be discussed with respect to background or natural concentrations. Metal solutes behave differently than organic solutes. While the fate and transport of metal solutes generally occur by the same three process described above, the fate of metals is significantly affected by groundwater and aquifer matrix chemistry. The concentration of metals and their movement are dependent on such things as ion exchange capacity, pH, and reduction/oxidation potential. Table 5-2 presents an assessment of relative environmental mobilities of inorganics as a function of Eh and pH. Different metals will behave differently under the same conditions. Metal solutes therefore, need to be examined individually. Section 5.3.4 examines the occurrence of individual metals at Site 36.

5.3 Fate and Transport Summary

The paragraphs which follow discuss transport mechanisms and the fate for the significant contaminants discussed in Section 4.0.

5.3.1 Volatile Organic Compounds

VOCs tend to be mobile in environmental media as indicated by their presence in groundwater and their corresponding MI values/retardation factors. Their environmental mobility is a function of high water solubilities, high vapor pressures, low K_{ow} and K_{oc} values, and high mobility indices.

In surface media, VOCs will readily volatilize into the atmosphere. Because VOCs are highly mobile in soil, they will leach to underlying groundwater, but will not partition significantly from the water column to sediment. In natural water and soil systems, VOCs will be biodegraded. Hydrolysis and oxidation are not important fate processes for VOCs in water. Direct photolysis is also not an important fate process for VOCs in groundwater.

Several chlorinated VOCs were detected in surface and subsurface soil samples. These VOCs include, trichloroethene, tetrachloroethene, and 1,2-dichloroethene. The concentrations of these VOCs are low, less than 10 $\mu\text{g}/\text{Kg}$. These same VOCs have also been identified as groundwater contaminants, with concentrations tending to be higher than those observed in soils.

At Site 36, chlorinated VOC contamination was found in the surficial aquifer. Based on groundwater flow direction, well clusters 36-GW10, 36-GW12, 36-GW13, and wells 36-GW01, 36-GW02, and 36-GW03 are downgradient of the debris area. Wells 36-GW01, 36-GW02, and 36-GW03 appear to be located just inside the debris area, while well clusters 36-GW10, 36-GW12, 36-GW13 are apparently outside the debris area.

Figure 4-3 shows the distribution of the chlorinated VOCs in groundwater. Based on each solute's MI value/retardation factor, each solute is expected to migrate at a different rate. Additionally over time, the original VOCs may be transformed to other VOCs. Based on groundwater flow direction and relative retardation factors, the following conceptual fate and transport model has been developed:

- 1) The source area may be located in the northern portion of the debris area (south of well cluster 36-GW10). 1,2-Dichloroethene has also been detected in wells 36-GW04 and 36-GW08. Both of these sample concentrations are low and located upgradient of this potential source area, and appear unrelated.
- 2) Contaminants appear to have migrated northward, in the prevalent direction of groundwater flow in this portion of Site 36. The relative percentage of the more mobile transformation product, 1,2-dichloroethene, is greater in well cluster 36-GW13 than in well cluster 36-GW10.
- 3) Contaminants with relatively lower mobility (trichloroethene and tetrachloroethene) are present throughout the plume. Additionally, a transformation product, 1,2-dichloroethene, was detected in groundwater samples. These facts suggest that the chlorinated VOCs have reached Brinson Creek. However, chlorinated VOCs have not been detected in surface water or sediments samples from Brinson Creek.
- 4) Contaminants have migrated downward within the lower portion of the surficial aquifer, but have not migrated to the Castle Hayne aquifer. Chlorinated VOCs were

observed at the highest concentrations at well 36-GW10IW. Chlorinated VOCs were not detected in 36-GW10DW, screened immediately below the Castle Hayne confining unit.

- 5) This source for the presence of 1,2-dichloroethene in wells 36-GW04 and 36-GW08 is unknown. 1,2-Dichloroethene has not been detected in wells located further upgradient.

5.3.2 Semivolatile Organic Compounds (SVOCs)

Polynuclear aromatic hydrocarbons are the primary group of SVOCs detected at Site 36. PAH contamination has been encountered at Site 36 at a few, limited, surface and subsurface sample locations.

Low water solubilities, high K_{ow} and K_{oc} values indicate a strong tendency for PAHs to adsorb to soils, and be immobile. PAHs have not been detected in groundwater, or in surface water, or sediment at significant concentrations. It appears that PAHs are not migrating.

5.3.3 Pesticides/Polychlorinated Biphenyls (PCBs)

Pesticides have been detected in surface and subsurface soils at several locations scattered throughout Site 36 (Figures 4-1 and 4-2). Pesticides have also been detected in most of the sediment samples in Brinson Creek and the unnamed tributary. The pattern of distribution and concentration suggests routine application for insect control rather than product disposal. Table 5-1 shows that pesticides are immobile, mainly due to their affinity for soil surfaces. Pesticides likely have migrated to stream sediment possibly through soil erosion and/or direct deposition from pesticide application at mosquito breeding areas. Pesticides will likely continue to accumulate in sediment as erosion of soils continues. Routine pesticide application is no longer practiced. Therefore the rate of accumulation should diminish with time due to diminishing availability of pesticides.

PCBs were detected in surface and subsurface soil samples a limited area around 36-OA-SB01. PCBs have low vapor pressures, low water solubilities, and high K_{oc} and K_{ow} values. Consequently, PCBs will tend to adsorb to soil and sediment and remain immobile in the absence of fugitive dust generation. At Site 36, PCBs have not been detected in groundwater, surface water, or sediment suggesting that they have remained immobile in the soils.

5.3.4 Metals

The dissolution of copper, lead, and zinc from sediment to surface water, or soils to groundwater has not resulted in concentrations exceeding Federal MCLs or state drinking water standards. Copper, lead, and zinc were observed in soil samples from the eastern portion of Site 36 at concentrations two orders of magnitude above base-specific background (Section 2.0). Neither metal appears in groundwater samples above Federal MCLs or state standards. Lead was detected in several sediment samples in the unnamed tributary and Brinson Creek above chronic screening values, but was not detected at significant concentrations in surface water samples.

Iron and manganese have occurred frequently in groundwater above Federal MCLs and state drinking water standards. The paragraphs which follow discuss the occurrence of these metals in

groundwater. Table 5-2 presents the relative mobilities of metals as a function of environmental conditions.

Iron and manganese were detected in 91 percent of groundwater samples from Site 36, and are ubiquitous in all media at MCB, Camp Lejeune. These compounds often exceed comparison criteria and can be contaminants-of-potential-concern for human health and/or ecological risk assessments. Previous studies at Camp Lejeune show that concentrations of iron and manganese are variable and can occur in sediments, surface water and groundwater at levels exceeding comparison criteria. It is possible that elevated levels of iron and manganese in a particular media may not be associated with waste disposal, but rather be representative of natural conditions.

In a study of trace elements in a coastal plain estuary (Cross, et. al., 1970), iron, manganese, and zinc were found in sediments, surface water, and worm tissue. The study was conducted over a two year period in a river estuary near Morehead City, North Carolina (approximately 40 miles northeast of Camp Lejeune). Multiple samples of surface water, sediment, and worms were collected monthly. Analysis was performed on an extract of the sediments. This study found that iron and manganese levels varied temporally. Levels decreased in samples collected at or near the Atlantic Ocean. The highest concentrations of iron, manganese, and zinc occurred inland, in a station in the Newport River. At this station, the mean levels of iron in sediment extract were reported to range from 380 $\mu\text{g/g}$ to 1,800 $\mu\text{g/g}$, while manganese ranged from 12 $\mu\text{g/g}$ to 71 $\mu\text{g/g}$. Median level of iron in surface water was 300 $\mu\text{g/L}$, while manganese was 22 $\mu\text{g/L}$. The study found that iron was most abundant, followed by manganese.

According to a study of chemical characteristics of natural waters (Hem, 1992), iron and manganese can occur in water through natural effects. Hem cited a report that observed manganese at 1.0 mg/L small streams due to low dissolved oxygen levels. Hem also reported that manganese can occur in groundwater above 1.0 mg/L. Manganese can dissolve into groundwater from manganese oxide coatings on soil/sediment particles. Manganese is a significant constituent of many igneous and metamorphic rocks. Small amounts of manganese are commonly present in limestone and dolomite, substituting for calcium. Partially cemented limestone and calcareous sediments are common in the Camp Lejeune area, and were observed at Site 36.

Hem observed iron in surface water at 1.4 mg/L due to organic complexing. Typically, iron in surface water is on the order of 10 $\mu\text{g/L}$. Iron can occur in groundwater at levels as high as 50 mg/L given certain chemical conditions (a pH between 6 and 8 SU and a bicarbonate activity less than 61 mg/L). A high level of dissolved iron can occur with oxidation of ferrous sulfides. Sulfur is altered to sulfate releasing ferrous iron. Metallic sulfides are common in sedimentary and igneous rocks, or soils/sediments with those source rocks. Hem reported, "The availability of iron for aqueous solutions is strikingly affected by environmental conditions, especially changes in degree or intensity of oxidation or reduction.

Iron and manganese were detected at significant levels only in groundwater at Site 36. The average concentration of iron and manganese in groundwater samples are 17 mg/L and 3 mg/L, respectively. These concentrations generally appear within natural conditions described by Hem.

5.4 References

Cardinall, A.P., Berg, S.A., and O.B. Lloyd. 1993. Hydrogeologic Framework of U.S. Marine Corps Base at Camp Lejeune, North Carolina: U.S. Geological Survey Water Resources Investigation Report. Report No. 93-4049.

Cross, Ford A., Duke, Thomas W., and James N. Willis. 1970. "Biogeochemistry of Trace Elements in a Coastal Plain Estuary: Distribution of Manganese, Iron, and Zinc in Sediments, Water, and Polychaetous Worms." Chesapeake Science. Vol. 11, No. 4, 221-234. December 1970.

Environmental Science and Engineering, Incorporated (ESE). 1988. Characterization Step Report for Hadnot Point Industrial Area, Marine Corps Base, Camp Lejeune, North Carolina. Prepared for the Department of the Navy, Naval Facilities Engineering Command, Atlantic Division, Norfolk, Virginia. ESE Project No. 49-02036-0150.

Feenstra S., Cherry, J.A., and B.L. Parker. 1995. Dense Chlorinated Solvents in Groundwater: Background History of the Problem. July 1995.

Fetter, C.W. 1986. Applied Hydrogeology. Charles E. Merrill Publishing Co., Columbus, Ohio.

Ford and Gruba. 1984. Methods of Determining Relative Contaminant Mobilities and Migration Pathways Using Physical-Chemical Data.

Hem. 1992. Study of Interpretation of the Chemical Characteristics of Natural Waters. USGS Water-Supply Paper 22254.

Howard, Philip H. 1989. Handbook of Environmental Fate and Exposure Data for Organic Chemicals - Pesticides. Lewis Publishers. Chelsea, Michigan.

Howard, Philip H. 1990. Handbook of Environmental Fate and Exposure Data for Organic Chemicals - Large Production and Priority Pollutants. Lewis Publishers. Chelsea, Michigan.

Howard, Philip H. 1991. Handbook of Environmental Fate and Exposure Data for Organic Chemicals - Solvents. Lewis Publishers. Chelsea, Michigan.

Laskowski, D.A., Goring, C.A., McCall, P.J., and R.L. Swann. 1983. "Terrestrial Environment in Environmental Risk Analysis for Chemicals." Environmental Risk Analysis for Chemicals. R.A. Conways, ed., Van Nostrand Reinhold Company, New York, New York.

Lyman, W.J., Rechl, W.F. and D.H. Rosenblatt. 1982. Handbook of Chemical Property Estimation Methods. McGraw-Hill, Inc., New York.

Nichols. 1993. Principle of Subsurface Contaminant Fate and Transport Modeling. (Seminar)

Sax N. and R. Lewis. 1987. Hawley's Condensed Chemical Dictionary. Van Norstrand Reinhold, New York.

Superfund Chemical Data Matrix (SCDM). 1991. United States Environmental Protection Agency Hazardous Site Evaluation Division. December 1991.

Swarthaugh, et al. "Remediating Sites Contaminated with Heavy Metals." Hazardous Materials Control. November/December 1992.

United States Environmental Protection Agency (USEPA). 1986. Chemical, Physical, and Biological Properties of Compounds Present at Hazardous Waste Sites. Office of Solid Waste and Remedial Response. Washington D.C. EPA/540/1-86/060. October 1986.

United States Environmental Protection Agency (USEPA). 1986. Superfund Public Health Evaluation Manual. Office of Emergency Response. Washington, D.C. October, 1986. EPA/540/1-86/060.

United States Department of Human and Health Services (USHHS). 1994. Toxicological Profile for 1,2-Dichloroethene. U.S. Department of Human and Health Services.

United States Department of Human and Health Services (USHHS). 1991 Toxicological Profile for Trichloroethene. U.S. Department of Human and Health Services.

United States Department of Human and Health Services (USHHS). 1990 Toxicological Profile for 1,2-Dichloroethene. U.S. Department of Human and Health Services.

Verscheuren, K. 1983. Handbook of Environmental Data on Organic Chemicals. Van Nostrand Reinhold Company, New York, New York.

SECTION 5.0 TABLES

TABLE 5-1

**ORGANIC PHYSICAL AND CHEMICAL PROPERTIES
SITE 36, CAMP GEIGER AREA DUMP
REMEDIAL INVESTIGATION CTO-0303
MCB, CAMP LEJEUNE, NORTH CAROLINA**

Contaminants of Potential Concern	Vapor Pressure (mm Hg)	Water Solubility (mg/L)	Log K _{ow}	K _{oc}	Specific Gravity (g/cm ³)	Henry's Law Constant (atm-m ³ /mole)	Mobility Index
Volatiles							
1,2-Dichloroethene (cis)	208	3500	0.70	49	--	7.59E-03	--
1,2-Dichloroethene (trans)	324	6300	0.48	59	1.26	6.56E-03	2.9
Trichloroethene	57.9	1100	2.38	126	1.46	9.1E-03	2.8
Tetrachloroethene	17.8	150	2.6	364	--	2.59E-02	--
1,1,2,2-Tetrachloroethane	5	2900	2.39	118	1.6	3.81E-04	2.2
Semivolatiles							
n-Nitroso-di-n-propylamine							
Benzo(a)anthracene	5.0E-09	0.014	5.61	5.34	NA	1.00E-06	-15.50
Benzo(a)pyrene	5.0E-09	0.0038	6.04	5.72	NA	4.90E-07	-16.40
Benzo(b)fluoranthene	1E-06 to 1E-07	0.009	6.57	6.26	NA	1.22E-06	-14.00
Bis(2-ethylhexyl)phthalate	6.45E-06	0.3	5.11	4-5	NA	1.1E-05	NA
Dibenz(a,h)anthracene	1.0E-10	5E-04	6.8	3.3E+06	--	7.33E-08	-22.1
Diethylphthalate	1.65E-03	1080	2.47	--	1.12	4.8E-07	-1.15/0.36
Di-n-butylphthalate	1E-05	13	5.6	1.7E+05	1.05	2.82E-07	-4.1/-2.9
Pyrene	6.85	0.14	5.32	4.91	NA	5.10E-06	-11.90
Pesticides							
4,4'-DDD	1.0E-06	0.09	5.99	4.47	NA	2.20E-08	-12.00
4,4'-DDE	6.5E-06	0.04	4.28	3.66	NA	6.80E-05	-10.00
4,4'-DDT	1.9E-07	0.0034	6.19	4.89	NA	1.58E-05	-14.00
Dieldrin	1.78E-07	0.195	3.5	1700	1.75	4.58E-07	-12
Endrin	3E-06	2.5E-04	4.56	--	NA	7.52E-06	--
Endosulfan sulfate ⁽¹⁾	1E-05	0.51, 0.45	3.83	--	NA	1.12E-05	--

TABLE 5-1 (Continued)

ORGANIC PHYSICAL AND CHEMICAL PROPERTIES
 SITE 36, CAMP GEIGER AREA DUMP
 REMEDIAL INVESTIGATION CTO-0303
 MCB, CAMP LEJEUNE, NORTH CAROLINA

Contaminants of Potential Concern	Vapor Pressure (mm Hg)	Water Solubility (mg/L)	Log K _{ow}	K _{oc}	Specific Gravity (g/cm ³)	Henry's Law Constant (atm-m ³ /mole)	Mobility Index
Endrin ketone ⁽²⁾	3E-06	2.5E-04	4.56	--	NA	7.52E-06	--
Endrin aldehyde ⁽²⁾	3E-06	2.5E-04	4.56	--	NA	7.52E-06	--
beta-BHC	2.8E-07	0.24	3.9	3,800	--	4.47E-07	--
gamma-BHC (Lindane)	1.6E-04	7.8	3.9	1080	1.87	7.85E-06	--
Heptachlor	3E-04	0.18	4.4	12,000	--	8.19E-04	--
alpha-Chlordane ⁽³⁾	4.6E-04	1.0E-01	5.54	NA	NA	4.85E-05	NA
gamma-Chlordane ⁽³⁾	4.6E-04	1.0E-01	5.54	NA	NA	4.85E-05	NA
PCBs							
Aroclor-1248 ⁽⁴⁾	7.7E-05	3.1E-02	6.04	5.3E+05	1.41	1.07E-03	--
Aroclor-1254 ⁽⁴⁾	4.1E-05	2.7E-03	5.72	6.3E+06	1.58	4.6E-03	-12.7

Notes:

NA = Not Available

⁽¹⁾ = Values substituted from endosulfan.

⁽²⁾ = Values substituted from endrin.

⁽³⁾ = Values substituted from chlordane.

⁽⁴⁾ = Values substituted from PCBs.

References:

Howard, 1989-1991
 USEPA, 1986 (SPHEM)
 SCDM, 1991
 Sax and Lewis, 1987
 SCDM, 1991
 USEPA, 1986
 USEPA, 1986a
 Verscheuren, 1983

TABLE 5-2

RELATIVE MOBILITIES OF METALS AS A FUNCTION OF ENVIRONMENTAL CONDITIONS (Eh, pH)
 SITE 36, CAMP GEIGER AREA DUMP
 REMEDIAL INVESTIGATION CTO-0303
 MCB, CAMP LEJEUNE, NORTH CAROLINA

Relative Mobility	Environmental Conditions			
	Oxidizing	Acidic	Neutral/ Alkaline	Reducing
Very high			Se	
High	Se, Zn	Se, Zn, Cu, Ni, Hg, Ag		
Medium	Cu, Ni, Hg, Ag, As, Cd	As, Cd	As, Cd	
Low	Pb, Ba, Se	Pb, Ba, Be	Pb, Ba, Be	
Very Low	Fe, Cr	Cr	Cr, Zn, Cu, Ni, Hg, Ag	Cr, Se, Zn, Cu, Ni, Hg, Pb, Ba, Be, Ag

Notes:

Se = Selenium	Cd = Cadmium
Zn = Zinc	Ba = Barium
Cu = Copper	Pb = Lead
Ni = Nickel	Fe = Iron
Hg = Mercury	Cr = Chromium
Ag = Silver	Be = Beryllium
As = Arsenic	Zn = Zinc

Source: Swartzbaugh, et al. "Remediating Sites Contaminated with Heavy Metals."
 Hazardous Materials Control, November/December 1992.

6.0 BASELINE HUMAN HEALTH RISK ASSESSMENT

The following subsections present the baseline human health risk assessment (BRA) conducted for Site 36, Camp Geiger Area Dump. This assessment was performed in accordance with the USEPA document Risk Assessment Guidance for Superfund, Human Health Evaluation Manual: Part A (USEPA, 1989). The purpose of the BRA is to assess whether the contaminants of potential concern (COPCs) at the site pose a current or future risk to human health in the absence of remedial action. COPCs are site-related contaminants used to quantitatively estimate human exposures and associated potential health effects. Because the purpose of the risk assessment is to estimate the degree of risk to human health and to be protective of human health, the approach of the USEPA guidance is designed to be conservative. This protectiveness is achieved by the use of assumptions and models that result in upper bound estimates of risk, i.e., the true or actual risk is expected to fall between the estimated value and zero. As a result, the actual site risks are unlikely to exceed the estimated upper bound values and are probably lower than the calculated risks. The following paragraphs present a brief overview of the risk assessment process and how the assessment affects further activity at the sites.

For the BRA, both current and future land use exposure scenarios were assumed for the site. The current scenario reflects potential human exposure pathways to the COPCs that presently exist at the site (i.e., exposure pathways currently available). Likewise, the future use scenario represents exposure pathways that are conceivable in the future (e.g., residential development). The future use is typically determined by zoning and the environmental setting of the site. The development of current and future use exposure scenarios is consistent with the methodology for baseline risk assessment, as specified by USEPA.

The National Contingency Plan (NCP) stipulates a range of acceptable cancer risk levels of 1×10^{-4} to 1×10^{-6} for total risk at a hazardous waste site (USEPA, 1990). These cancer risk levels represent the probability of an individual developing cancer over his or her lifetime if exposed to the COPCs at the site. For example, a risk level of 1×10^{-6} is the probability that one person in 1,000,000 exposed persons will develop cancer in a lifetime. The total noncarcinogenic acceptable risk level is a hazard index of less than or equal to 1.0. This noncancer risk level depicts a level at or below which adverse systemic effects are not expected in the exposed population.

A remedial action is recommended when either the total cancer or noncancer risks are above the criteria established by the NCP. Some form of remedial action also is necessary when either the current or future exposure point concentrations at the site are above the applicable or suitable analogous standards (e.g., maximum contaminant levels [MCLs] for drinking water) for those COPCs for which standards exist. When a remedial action is necessary, applicable or relevant and appropriate requirements (ARARs) and/or risk-based cleanup levels are used in determining acceptable concentrations in the environmental media. No remedial response is required when the cancer and noncancer criteria and the ARARs are not exceeded.

6.1 Introduction

The BRA investigates the potential for COPCs to affect human health and/or the environment, both now and in the future, under a "no further remedial action scenario." The BRA process evaluates the data generated during the sampling and analytical phase of the RI, identifying areas of interest and COPCs with respect to geographical, demographic, and physical and biological characteristics of the study area. These characteristics, combined with the current understanding of physical and

chemical properties of the site-associated constituents (with respect to environmental fate and transport processes), are then used to estimate the concentrations of contaminants at the end points of logical exposure pathways. Finally, contaminant intakes by hypothetical receptors are determined and combined with the toxicological properties of the contaminants to estimate (inferentially) the potential public health impacts posed by constituents detected at the site.

The BRA for the site was conducted in accordance with current USEPA Risk Assessment Guidance (USEPA, 1989 and USEPA, 1991), and USEPA Region IV Supplemental Risk Guidance (USEPA, 1992c).

The components of the BRA include the following:

- Hazard Identification: determination as to whether a substance has the potential to elicit an adverse effect (toxicity) upon exposure to humans
- Exposure Assessment: identification of the human population(s) likely to be exposed and the development of specific exposure pathways for the population
- Toxicity Assessment: quantification of the relationship between the human exposure and the probability of occurrence (risk) of a toxic response
- Risk Characterization: development of a quantitative estimation of the potential risk from a combination of information collected during the exposure and toxicity assessment
- Uncertainty Analysis: identification and qualitative discussion of any major sources of uncertainty pertaining to the finding of the BRA
- Conclusions: summarization and conclusion of the results of the BRA relating to the total site risk are drawn

Each of these components of the BRA is discussed and addressed for the site in the following subsections. Introductory text is presented first, followed by a site-specific discussion. Referenced tables and figures are presented after the text portion of this section.

6.2 Hazard Identification

Data generated during the remedial investigation and previous studies at the site were used to draw conclusions and to identify data gaps in the BRA. The data were evaluated to assess which data were of sufficient quality to include in the risk assessment. The objective when selecting data to include in the risk assessment was to provide accurate and precise data to characterize contamination and evaluate exposure pathways.

6.2.1 Data Evaluation and Reduction

The initial hazard identification step entailed the validation and evaluation of the site data to determine its usability in the risk assessment. Validation was conducted by an independent third party (Heartland Environmental Services, Inc.). Validation of the analytical data is included to verify that proper quality assurance/quality control (QA/QC) was performed and that the corresponding

results were within the specified method control limits. This process resulted in the identification of COPCs for the site. During this validation and evaluation, data that would result in inaccurate conclusions (e.g., data that were rejected or attributed to blank contamination, as qualified by the validator) were reduced within the data set. Data reduction entailed the removal of unreliable data from the original data set based on the guidelines established by USEPA. A summary of the data quality was presented in Section 4.1, Data Quality.

6.2.2 Identification of Data Suitable for Use in a Quantitative Risk Assessment

To provide for accurate conclusions to be drawn from sampling results, analytical data were reviewed and evaluated. During this review and evaluation, data that would lead to inaccurate conclusions were reduced within each data set. This section presents the criteria that were used to review, reduce, and summarize the analytical data. These criteria are consistent with USEPA guidance for data reduction.

Six environmental media were investigated at Site 36 during this RI: surface soils, subsurface soils, shallow and deep groundwater, surface water, sediment, and biota (i.e., fish and crab tissue). Surface soil samples were collected from the 0- to 12-inch interval, and subsurface soil from greater than 12-inches below ground surface. Surface water, sediment, and fish and crab tissue samples were collected from the two surface water bodies of concern at the site: Brinson Creek and the unnamed tributary. The fish and crab samples were collected from Brinson Creek.

For the BRA, the surface soil and subsurface soil data were evaluated as single data sets. That is, the data were not segregated into areas of concern. The shallow and deep aquifer were evaluated as a single unit, because it has been shown that there is no separation between the two aquifers. A potential interconnection exists via leakage, etc. (see Section 2.0 of this report). Consequently, exposure to both sources of groundwater were evaluated. Similarly, the surface water and sediment data collected from both Brinson Creek and the unnamed tributary were combined and evaluated as single data sets. The unnamed tributary flows into Brinson Creek and is a part of this water system. Receptors can become exposed to both water sources while trespassing or participating in recreational activities close to the creek. As such, the data sets were evaluated together. These media were assessed for potential risk to human receptors.

Data collected during the February to May, 1995, and October, 1995, sampling events were evaluated in this risk assessment. The previous investigations conducted at this site are detailed in Section 1.0 of this report.

Information relating to the nature and extent of contamination at the site is provided in detail in Section 4.0 of this volume of the report. The discussion provided in Section 4.0 also was utilized in the selection of COPCs at the site. The reduced data sets for all media of concern at the site are provided in Appendices H and I of this report.

6.2.3 Criteria Used in Selection of COPCs

This section presents the criteria used in the selection of COPCs for the evaluation of potential human health risk. As exemplified by the data summary tables in Appendices H and I, the number of constituents positively detected at least once during the field investigation is large. Quantifying risk for all positively identified parameters may distract from the dominant risks presented by the site. Therefore, the data set (i.e., resulting data set after applying the criteria listed in the previous

section) was reduced to a list of COPCs. As stated previously, COPCs are site-related contaminants used to quantitatively estimate human exposures and associated potential health effects.

The selection of the COPCs was based on a combination of detected concentrations; toxicity; frequency of detection; comparison to background values, including site-specific, base-specific and published ranges; and comparison of physiochemical properties, including mobility, persistence, and toxicity. In addition, historical information pertaining to past site activities was considered. USEPA guidance states that a contaminant may not be retained for quantitative evaluation in the BRA if: (1) it is detected infrequently in an environmental medium (e.g., equal to or less than 5 percent for at least 20 samples per data set), (2) it is absent or detected at low concentrations in other media, or (3) site history does not provide evidence the contaminant to be present (USEPA, 1989). To qualitatively assess the COPCs, comparisons of results to federal and state criteria and Region III Risk-Based Concentrations (RBCs) (USEPA, 1995b) were used. A brief description of the selection criteria used in choosing final COPCs is presented below. A contaminant did not need to meet the criteria of all of these three categories in order to be retained as a COPC.

6.2.3.1 Site Setting

The Camp Geiger Area Dump (Site 36) is located approximately 1,000 feet east of Camp Geiger and 500 feet west of the New River, adjacent to the Camp Geiger Sewage Treatment Plant (STP). It is approximately 20 acres in size. The site is comprised primarily of open fields and wooded areas. A gravel road bisects the site and provides access to Jack's Point Recreation Area, located approximately one-quarter mile east of the study area. The site is bordered to the north by Brinson Creek, to the east by woods, to the south by an unnamed tributary to Brinson Creek, and to the west by an improved (i.e., coarse gravel) road. Further to the west of the improved road lies an abandoned railroad right-of-way, once part of the Seaboard Coastline Railroad.

Site History

From the late 1940s to the late 1950s, Site 36 was used for the disposal of municipal wastes and mixed industrial wastes, including garbage, waste oils, solvents, and hydraulic fluids from the MCAS, New River Air Station. Disposal records indicate that all waste solvents and oils were burned at this site. Previous investigations have indicated that most of this material was initially burned and then buried. However, unburned material was also reportedly buried.

According to interviews conducted by Water and Air Research, Inc. (WAR) during the Initial Assessment Study (IAS), less than five percent of all waste hydrocarbon material generated at the air station was disposed of at Site 36. The remaining waste oil was reportedly used for dust control on roads or went directly into storm drains (WAR, 1983).

During a site visit conducted in March, 1994, scattered debris (i.e., trees, glass, and metal), buried wire, and general litter was noted on-site. In addition, a few partially buried containers and 55-gallon drums and several mounds of construction debris were located in a swampy area southwest of the former dump. Fifty-five gallon drums containing unidentifiable material and 5-gallon pails labeled "alkaline material" and "lubrication oil" were found south of the area where the unnamed tributary crosses the main access road.

A site investigation was performed by WAR in 1984. Additional investigations were conducted in 1986 and 1987 by Environmental Science and Engineering, Inc. (ESE). Levels of cadmium,

chromium, lead, and phenols were detected in the groundwater (i.e., in both downgradient and upgradient wells) during the 1984 investigation. These levels exceeded federal and state groundwater criteria. Trans-1,2-dichloroethene (i.e., 2 µg/L), was detected at a low concentration, in an upgradient well only. The surface water and sediment from Brinson Creek and the unnamed tributary were also sampled. Trace levels of trans-1,2-dichloroethene, lead, and total phenols were detected in surface water and sediment. Chromium, lead, oil and grease, and phenols were detected in sediment.

The most recent sampling event included investigations of the following environmental media: background surface and subsurface soil, on-site surface and subsurface soil, shallow and deep groundwater, and surface water and sediment from Brinson Creek and the unnamed tributary. In addition, aquatic organisms were collected from Brinson Creek. A preliminary review of the unvalidated laboratory data indicates the presence of organic solvent constituents in the groundwater (i.e., trichloroethene [TCE], 1,2-dichloroethene [1,2-DCE], and 1,1,2,2-tetrachloroethene [1,1,2,2-PCE]) and soil, pesticides and PCBs in the surface soil, and metals, namely lead, in the soil and sediment.

Potable Water

There are 10 potable wells within one-mile radius of Site 36. Five of these wells are operational. All supply wells are located upgradient of Site 36 based on the northeasterly groundwater flow direction under Site 36.

6.2.3.2 Frequency of Detection

In general, constituents that were detected infrequently (e.g., equal to or less than 5 percent, when at least 20 samples of a medium are available) may be anomalies due to sampling or analytical errors or may be present simply in the environment due to past or current site activities. It should be noted, however, that detected constituents were individually evaluated prior to exclusion from the BRA. Physiochemical properties (i.e., fate and transport) and toxicological properties for each detected constituent were evaluated (see following subsections).

6.2.3.3 Comparison to Background

Sample concentrations were compared to site-specific (i.e., twice the base-specific average concentration) background levels. Background information was available for all media of concern at the site, except groundwater. The results of these comparisons are presented in Tables 6-1 through 6-8.

6.2.3.4 Physiochemical Properties

Mobility

The physical and chemical properties of a contaminant are responsible for its transport in the environment. These properties, in conjunction with site conditions, determine whether a contaminant will tend to volatilize into the air from surface soils or surface waters or be transported via advection or diffusion through soils, groundwaters, and surface waters. Physical and chemical properties also describe a contaminant's tendency to adsorb onto soil/sediment particles. Environmental mobility can correspond to either an increased or decreased potential to affect human health and/or the environment.

Persistence

The persistence of a contaminant in the environment depends on factors such as the microbial content of soil and water, organic carbon content, the concentration of the contaminant, climate, and the ability of the microbes to degrade the contaminant under site conditions. In addition, chemical degradation (i.e., hydrolysis), photochemical degradation, and certain fate processes such as sorption may contribute to the elimination or retention of a particular compound in a given medium.

6.2.3.5 Toxicity

The potential toxicity of a contaminant is an important consideration when selecting COPCs for further evaluation in the human health assessment. For example the weight-of-evidence (WOE) classification should be considered in conjunction with concentrations detected at the site. Some effects considered in the selection of COPCs include carcinogenicity, mutagenicity, teratogenicity, systemic effects, and reproductive toxicity. Bioaccumulation and bioconcentration properties may affect the severity of the toxic response in an organism and/or subsequent receptors and are evaluated if relevant data exist.

Despite their inherent toxicity, certain inorganic contaminants are essential nutrients. Essential nutrients need not be considered for further consideration in the quantitative risk assessment if they are present in relatively low concentrations (i.e., below twice the average base-specific background levels or slightly elevated above naturally occurring levels) or if the contaminant is toxic at doses much higher than those which could be assimilated through exposures at the site. Due to the difficulty of determining nutrient levels that were within acceptable dietary levels, only essential nutrients present at low concentrations (i.e., only slightly elevated above background) were eliminated from the BRA. Essential nutrients, however, were included in the ecological risk evaluation.

6.2.3.6 Contaminant Concentrations in Blanks

Sample concentrations were compared quantitatively to investigation-related blank concentrations. Sample concentrations of parameters that are typical laboratory or field contaminants (i.e., acetone, 2-butanone, methylene chloride, toluene, and phthalate esters) that exceeded blank concentrations by a factor of 10 and other parameter concentrations that exceeded blank concentrations by a factor of five were considered to be site related. Parameters not meeting this criteria were considered artifacts from field or laboratory practices and treated as non-detects.

For Site 36, the following organics were found in the blanks: acetone (24 µg/L), chloroform (13 µg/L), 2-butanone (29 µg/L), bromodichloromethane (13 µg/L); and dibromochloromethane (10 µg/L).

6.2.3.7 Federal and State Criteria and Standards

Contaminants detected at the site were compared to state and federal standards, criteria, and/or To Be Considered levels (TBCs). These comparisons may provide some qualitative information as to the relative potential for health impacts resulting from the site. It should be noted that COPC concentration ranges were directly compared to each standard/criteria/TBC. This comparison did not take into account the additive or synergistic effects of those constituents without standards or criteria. Consequently, conclusions regarding potential risk posed by each site cannot be inferred

from this comparison. A brief explanation of the standards/criteria/TBCs used for the evaluation of COPCs is presented below.

North Carolina Water Quality Standards (NCWQSs) - Groundwater - NCWQSs are the maximum allowable concentrations resulting from any discharge of contaminants to the land or waters of the state, which may be tolerated without creating a threat to human health or which otherwise render the groundwater unsuitable for its intended purpose.

Maximum Contaminant Levels (MCLs) - Federal Groundwater Standards - 40 CFR 161 - MCLs are enforceable standards for public water supplies promulgated under the Safe Drinking Water Act and are designed for the protection of human health. MCLs are based on laboratory or epidemiological studies and apply to drinking water supplies consumed by a minimum of 25 persons. They are designed for prevention of human health effects associated with a lifetime exposure (70-year lifetime) of an average adult (70 kg) consuming 2 liters of water per day. MCLs also consider the technical feasibility of removing the contaminant from the public water supply.

Health Advisories (HAs) - HAs are guidelines developed by the USEPA Office of Drinking Water for nonregulated constituents in drinking water. These guidelines are designed to consider both acute and chronic toxic effects in children (assumed body weight 10 kg) who consume 1 liter of water per day or in adults (assumed body weight 70 kg) who consume 2 liters of water per day. HAs are generally available for acute (1 day), subchronic (10 days), and chronic (longer-term) exposure scenarios. These guidelines are designed to consider only threshold effects and, as such, are not used to set acceptable levels of potential human carcinogens.

USEPA Region III COC Screening Values - COC screening values are derived using conservative USEPA promulgated default values and the most recent toxicological criteria available. COC screening values for potentially carcinogenic and noncarcinogenic chemicals are individually derived based on a target incremental lifetime cancer risk (ILCR) of 1×10^{-6} and a target hazard quotient of 0.1, respectively. For potential carcinogens, the toxicity criteria applicable to the derivation of COC screening values are oral and inhalation cancer slope factors; for non carcinogens, they are chronic oral and inhalation reference doses. These toxicity criteria are subject to change as more updated information and results from the most recent toxicological/epidemiological studies become available. Therefore, the use of toxicity criteria in the derivation of COC screening values requires that the screening concentrations be updated periodically to reflect changes in the toxicity criteria.

Since the most recent COC screening values table was issued by USEPA in October 1995, the values from these tables can be updated by incorporating information from another set of tables containing risk-based concentrations (RBCs) that are issued by USEPA Region III on a quarterly basis. The RBCs are derived using the same equations and USEPA promulgated default exposure assumptions that were used by Region III to derive the COC screening values. In addition, the quarterly RBCs for potentially carcinogenic chemicals are based on a target ILCR of 1×10^{-6} . The only difference in the derivation methodologies for the COC screening values and the RBCs is that the RBCs for noncarcinogens are based on a target hazard quotient of 1.0 rather than 0.1. The COC screening values for noncarcinogens are to be derived based on a target hazard quotient of 0.1, to account for cumulative risk from multiple chemicals in a medium. Re-derivation of the quarterly noncarcinogenic RBCs based on a target hazard quotient of 0.1, while using the most recent toxicological criteria available, results in a set of values that can be used, as a COC screening values. In other words, an updated set of COC screening values can be attained each quarter by using the

carcinogenic RBCs issued quarterly by USEPA Region III and dividing the accompanying noncarcinogenic RBCs by a factor of 10.

North Carolina Water Quality Standards (Surface Water) - The NCWQSs for surface water are the standard concentrations that, either alone or in conjunction with other wastes in surface waters, will neither render waters injurious to aquatic life, wildlife, or public health, nor impair the waters for any designated use.

Ambient Water Quality Criteria - AWQCs are non-enforceable regulatory guidelines and are of primary utility in assessing acute and chronic toxic effects in aquatic systems. They may also be used for identifying the potential for human health risks. AWQCs consider acute and chronic effects in both freshwater and saltwater aquatic life, and potential carcinogenic and noncarcinogenic health effects in humans from ingestion of both water (2 liters/day) and aquatic organisms (6.5 grams/day), or from ingestion of water alone (2 liters/day). The human health AWQCs for potential carcinogenic substances are based on the USEPA's specified incremental cancer risk range of one additional case of cancer in an exposed population of 10,000,000 to 100,000 (i.e. the 10^{-7} to 10^{-5} range).

Sediment Screening Levels - Sediment Screening Levels (SSLs) have been compiled to evaluate the potential for contaminants in sediments to cause adverse health effects (Long, *et al.*, 1995; Long and Morgan 1991; and, USEPA, 1995b). The lower ten percentile (Effects Range-Low [ER-L]) and the median percentile (Effects Range-Median [ER-M]) of biological effects have been developed for several contaminants. The concentration below the ER-L represents a minimal-effects range (adverse effects would be rarely observed). The concentration above the ER-L but below the ER-M represents a possible-effects range (adverse effects would occasionally occur). Finally, the concentration above the ER-M represents a probable-effects range (adverse effects would probably occur).

As stated previously, COPCs in all media of concern at the site were compared with these aforementioned criteria. The results of the standards/criteria/TBC comparison for the site are presented in Tables 7-1 through 6-8. The results are discussed in the following section.

6.2.4 Contaminants of Potential Concern (COPCs)

The following sections present an overview of the analytical data obtained for each medium and the subsequent retention or elimination of COPCs using the aforementioned criteria for selection of COPCs.

6.2.4.1 Surface Soil

In surface soil, the following COPCs were identified: n-nitroso-di-n-propylamine, benzo(a)anthracene, benzo(b)fluoranthene, benzo(a)pyrene, dibenzo(a,h)anthracene, indeno(1,2,3-cd)pyrene, aldrin, dieldrin, 4,4'-DDE, 4,4'-DDT, alpha-chlordane, gamma-chlordane, Aroclor-1248, and Aroclor-1254. These COPCs were detected frequently and exceeded base-specific background levels and residential soil Screening levels. These organic and inorganic results are summarized in Tables 6-1 and 6-2, respectively.

In surface soil, 61 samples were analyzed for VOCs. Six VOCs were detected: acetone, trichloroethene, tetrachloroethene, toluene, styrene, and xylene. However, these VOCs were detected infrequently (i.e., less than 5 percent) and at levels below Region III residential soil

screening levels (e.g., toluene). As a result, these VOCs were not identified as COPCs in surface soil.

Fifty-seven samples were analyzed for SVOCs in surface soil. Twenty-one SVOCs were detected (see Table 6-1). Of the 21 SVOCs detected, the following were determined to be COPCs: n-nitroso-di-n-propylamine, benzo(a)anthracene, benzo(b)fluoranthene, benzo(a)pyrene, dibenzo(a,h)anthracene, indeno(1,2,3-cd)pyrene. The maximum concentrations of these SVOCs exceeded Region III residential soil screening levels. On comparison to these same screening levels, the following contaminants were detected at maximum levels below the residential soil screening levels: phenanthrene, fluoranthene, pyrene, chrysene, and bis(2-ethylhexyl)phthalate. Consequently, these SVOCs were not included as COPCs. There is no RBC available for phenanthrene. The RBC for pyrene was substituted. The following chemicals were detected in the surface soils, but were excluded from the risk evaluation due to low frequency of detection (i.e., equal to or less than 5 percent): naphthalene, 2-methylnaphthalene, acenaphthene, dibenzofuran, fluorene, anthracene, carbazole, butylbenzylphthalate, benzo(k)fluoranthene, and benzo(g,h,i)perylene.

Fifty-seven surface soil samples were analyzed for pesticides and PCBs. Seventeen pesticides/PCBs were detected (see Table 6-1). Of these seventeen contaminants, eight pesticides/PCBs were identified as COPCs due to a high frequency of detection (as noted for several of the COPCs) and/or an exceedance of the Region III residential soil screening levels: aldrin, dieldrin (21 detects in 57 samples or 37 percent), 4,4'-DDE (49 detects in 57 samples or 86 percent), 4,4'-DDT (48 detects in 57 samples or 84 percent), alpha-chlordane (15 detects in 57 samples or 26 percent), gamma-chlordane (10 detects in 57 samples or 18 percent), Aroclor-1248 (9 detects in 57 samples or 16 percent), and Aroclor-1254 (3/57). Heptachlor epoxide and 4,4'-DDD were detected at maximum concentrations below the Region III screening levels. As a result, heptachlor epoxide and 4,4'-DDD were not identified as COPCs. The following chemicals were detected in the surface soils, but were excluded from the risk evaluation due to low frequency of detection (i.e., equal to or less than 5 percent): heptachlor, endrin, endrin ketone, and endrin aldehyde.

Metals analyses were performed on fifty-two surface soil samples. Twenty-two metals were detected frequently, as shown in Table 6-2. Aluminum, chromium, and iron were detected in each of the surface soil samples. The COPCs selected included these metals and antimony, arsenic, cadmium, copper, lead, and mercury. In general, these COPCs also exceeded site background levels and/or Region III residential soil screening levels. The following contaminants were detected at maximum concentrations below the residential soil screening levels: barium, cobalt, manganese, nickel, silver, vanadium, and zinc. As a result, these chemicals were excluded from the evaluation. Although beryllium was detected at a maximum concentration greater than the RBC screening level, it was detected infrequently (2 percent) and below the base-specific background level. Essential nutrients also were excluded. In surface soil, these chemicals included calcium, magnesium, potassium, and sodium.

6.2.4.2 Subsurface Soil

In subsurface soil, the COPCs were identified as the following: benzo(a)pyrene, dieldrin, 4,4'-DDT, alpha-chlordane, gamma-chlordane, Aroclor-1248, aluminum, antimony, arsenic, beryllium, cadmium, chromium, copper, iron, lead, manganese, mercury, and zinc. These COPCs were detected frequently and exceeded base-specific background levels and residential soil screening levels. The organic and inorganic results are presented in Tables 6-3 and 6-4, respectively.

Sixty-two samples were analyzed for VOCs. Seven VOCs were detected. The maximum concentrations of acetone, toluene, and xylene did not exceed Region III residential soil screening levels. As a result, these VOCs were excluded from evaluation. The following chemicals were detected in the subsurface soils, but were excluded from the risk evaluation due to low frequency of detection (i.e., equal to or less than 5 percent): 1,2-dichloroethene (total), 2-butanone, trichloroethene, and benzene. Consequently, no VOCs were selected for evaluation.

SVOC analyses were performed on 58 subsurface soil samples. Nineteen SVOCs were detected in the subsurface soil (see Table 6-3). Benzo(a)pyrene was detected frequently (i.e., 7 percent) and at a maximum concentration greater than the screening level. As a result, it was identified as a COPC. Of the remaining 18 contaminants, the maximum concentrations of the following contaminants did not exceed Region III residential soil screening levels: pyrene, chrysene, bis(2-ethylhexyl)phthalate, and benzo(b)fluoranthene. The following chemicals were detected in the subsurface soils, but were excluded from the risk evaluation due to low frequency of detection (i.e., equal to or less than 5 percent): 1,4-dichlorobenzene, 2-methylphenol, 4-methylphenol, isophorone, naphthalene, 2-methylnaphthalene, phenanthrene, di-n-butylphthalate, fluoranthene, butylbenzylphthalate, benzo(a)anthracene, benzo(k)fluoranthene, indeno(1,2,3-cd)perylene, and benzo(g,h,i)perylene. Consequently, these SVOCs were not included as COPCs.

Fifty-six samples were analyzed for pesticides and PCBs. Thirteen pesticides/PCBs were detected. Dieldrin (detected at a frequency of 30 percent), 4,4'-DDT (detection frequency of 50 percent), alpha-chlordane (detected at a frequency of 21 percent), gamma-chlordane (detected at a frequency of 16 percent), and Aroclor-1248 (detection frequency of 9 percent) were detected frequently and at maximum levels greater than the screening levels. The maximum concentrations of the following contaminants did not exceed the screening levels: gamma-BHC (lindane), aldrin, heptachlor epoxide 4,4'-DDE, endrin, endosulfan II, 4,4'-DDD, and endrin aldehyde. As a result, these contaminants were not included in the evaluation.

Metals analyses were performed on 51 samples. Twenty-two metals were detected. As stated previously, aluminum, antimony, arsenic, beryllium, cadmium, chromium, copper, iron, lead, manganese, mercury, and zinc were detected frequently and at maximum levels greater than screening levels. In fact, aluminum, and iron were detected in all the samples. Consequently, these metals were identified as COPCS. The following metals were detected at maximum concentrations less than screening levels: barium, cobalt, nickel, selenium, silver, vanadium, and zinc. As a result, these metals and essential nutrients were excluded. In subsurface soil, these chemicals included calcium, magnesium, potassium, and sodium.

6.2.4.3 Shallow and Deep Groundwater

As stated previously, the shallow and deep groundwater analytical results were combined into one data set and evaluated accordingly. In the shallow and deep groundwater, the COPCs were identified as the following: 1,2-dichloroethane (total), trichloroethene, tetrachloroethene, 1,1,2,2-tetrachloroethane, bis(2-ethylhexyl)phthalate, arsenic, barium, cadmium, iron, and manganese. These COPCs were detected frequently and exceeded Region III tap water screening levels. These results are shown in Table 6-5.

Five VOCs were detected in 29 groundwater samples. As mentioned previously, four of these five VOCs were identified as COPCs based on detection frequencies greater than 5 percent and

exceedances of screening levels. Methylene chloride was detected at a frequency of 3 percent. As a result, it was not included in the evaluation.

Only one SVOC, bis(2-ethylhexyl)phthalate, was detected in the 17 groundwater samples analyzed for SVOCs. This SVOC was detected frequently (i.e., 12 percent) and at a level greater than the tap water screening level. As a result, it was retained as a COPC.

Similarly, only one pesticide, 4,4'-DDD, was detected in the 18 groundwater sample analyzed for pesticides/PCBs. It was detected once and at a level less than the screening level. Consequently, it was not selected as a COPC.

Sixteen metals were detected in the 22 samples analyzed for inorganics. As stated previously, arsenic, barium, cadmium, iron, and manganese were selected as COPCs. On comparison of the maximum concentrations of the following contaminants to the Region III tap water screening levels, they did not exceed the screening levels: aluminum, nickel, selenium, vanadium, and zinc. Mercury was detected infrequently (i.e., 5 percent). Essential nutrients were also excluded. In shallow and deep groundwater, these chemicals included calcium, magnesium, potassium, and sodium.

6.2.4.4 Surface Water

In the surface water, the following chemicals were identified as COPCs: 1,2-dichloroethene (total), antimony, barium, iron, manganese, molybdenum, and vanadium. These COPCs were detected frequently and exceeded site background levels (i.e., sample locations upstream of the site). Table 6-6 provides a summary of these results.

Only one VOC, 1,2-dichloroethene (total), was detected once in the 7 surface water samples. It was included in the evaluation.

Fourteen metals were detected in the 7 surface water samples. Antimony, barium, iron, manganese, molybdenum, and vanadium were identified as COPCs. Copper, nickel, and thallium were detected at levels below state and federal human health surface water criteria. As a result, these metals were not identified as COPCs. Aluminum was detected at a maximum concentration below the site background level. The essential nutrients detected in the surface water, calcium, magnesium, potassium, and sodium, were excluded from the evaluation.

6.2.4.5 Sediment

The following chemicals were selected as COPCs in the sediment: tetrachloroethene, anthracene, diethylphthalate, di-n-butylphthalate, bis(2-ethylhexyl)phthalate, dieldrin, 4,4'-DDE, endrin, 4,4'-DDD, endosulfan sulfate, 4,4'-DDT, endrin ketone, endrin aldehyde, alpha-chlordane, aluminum, barium, beryllium, cadmium, cobalt, copper, iron, lead, manganese, mercury, nickel, selenium, thallium, vanadium, and zinc. These COPCs were detected frequently and exceeded site background levels. These results are presented in Table 6-7.

One VOC, tetrachloroethene, was detected in the 13 sediment samples analyzed for VOCs. It was retained as a COPC.

Five SVOCs were detected in the 13 sediment samples analyzed for SVOCs. Anthracene, diethylphthalate, di-n-butylphthalate, and bis(2-ethylhexyl)phthalate were identified as COPCs. The

maximum concentration of pyrene was detected below state and federal criteria. It was not retained as a COPC.

Ten pesticides were detected in the 13 sediment samples analyzed for pesticide and PCBs. Dieldrin, 4,4'-DDE, endrin, 4,4'-DDD, endosulfan sulfate, 4,4'-DDT, endrin ketone, endrin aldehyde, and alpha-chlordane were retained as COPCs. Aldrin was detected at a maximum level that did not exceed the site background concentration. It was not included in the evaluation as a COPC.

Twenty-one metals were detected in the 15 sediment samples. The metals COPCs were aluminum, barium, beryllium, cadmium, cobalt, copper, iron, manganese, mercury, nickel, selenium, thallium, vanadium, and zinc. The maximum concentrations of arsenic and chromium were detected below state and federal criteria. The essential nutrients, calcium, magnesium, potassium, and sodium, were also excluded from the assessment. These metals were not selected as COPCs.

Lead was detected at an elevated level in sediment (i.e., 15,100 mg/kg). The high lead concentration in the sediment was detected at the sample collected adjacent to the site (36-SD06). The maximum level of lead in sediment, excluding this detection, was 148 mg/kg, which is well below the screening level of 400 mg/kg. In addition, based on additional sediment sampling, it appears that the high lead concentration detected in 36-SD06 may have been an anomaly. Two other samples were collected, and the resulting detections were 15.9 mg/kg and 21.9 mg/kg. Based on this information, this elevated level does not appear to be indicative of actual site concentrations. As a result, lead was not selected as a COPC in sediment, and the potential health risks to a child receptor from exposure to lead in sediment were not evaluated.

6.2.4.6 Fish Tissue

The COPCs identified in the fish tissue fillet samples are as follows: beta-BHC, gamma-BHC (lindane), heptachlor, aldrin, heptachlor epoxide, dieldrin, 4,4'-DDE, endrin, 4,4'-DDD, 4,4'-DDT, alpha-chlordane, arsenic, cadmium, chromium, copper, iron, mercury, selenium, silver, vanadium, and zinc. These COPCs were detected frequently and exceeded fish tissue screening levels. Table 6-8 contains these results.

Five VOCs, methylene chloride, acetone, carbon disulfide, 2-butanone, and toluene, were detected in the 15 fish tissue samples analyzed for VOCs. However, these contaminants were detected at maximum levels below the fish tissue screening levels. As a result, they were not retained as COPCs.

No SVOCs were detected in the fish tissue samples. Consequently, no SVOCs were identified as COPCs.

Of the 19 fish tissue samples analyzed for pesticides/PCBs, 14 pesticides were detected. Eleven of these pesticides were retained as COPCs. The following contaminants were detected at maximum levels below the fish tissue screening levels: endosulfan II, endrin ketone, and endrin aldehyde. Consequently, these contaminants were not retained as COPCs.

Seventeen metals were detected in the 19 fish tissue samples analyzed for inorganics. Arsenic, cadmium, chromium, copper, iron, mercury, selenium, silver, vanadium, and zinc were identified as COPCs. Three metals were detected at levels less than the screening values: aluminum, barium,

and manganese. These metals were excluded from the evaluation. The essential nutrients were also excluded from the evaluation. These nutrients were calcium, magnesium, potassium, and sodium.

6.2.4.7 Crab Tissue

The following contaminants were selected as COPCs in the crab tissue: beta-BHC, gamma-BHC (lindane), heptachlor, aldrin, dieldrin, 4,4'-DDE, 4,4'-DDD, alpha-chlordane, arsenic, cadmium, copper, lead, selenium, and zinc. Table 6-8 presents a summary of this information.

Acetone and methylene chloride were detected in the three samples. However, these VOCs are common laboratory contaminants and were not detected in the surrounding surface water or sediment. Consequently, these VOCs were not retained as COPCs in crab tissue.

No SVOCs were detected in the samples. As a result, no SVOCs were identified as COPCs.

Nine pesticides were detected in the three samples. Beta-BHC, gamma-BHC (Lindane), heptachlor, aldrin, dieldrin, 4,4'-DDE, 4,4'-DDD, and alpha-chlordane were included as COPCs. On comparison of crab tissue concentrations of contaminants to fish tissue screening values 4,4'-DDT was detected below the corresponding screening level. It was not selected as a COPC.

Fourteen metals were found in the three crab tissue samples. Arsenic, cadmium, cobalt, copper, lead, selenium, and zinc were retained as COPCs. The following contaminants were found at levels less than the corresponding fish tissue screening levels: aluminum, and manganese. These two metals were excluded from the evaluation. Detected essential nutrients, calcium, iron, magnesium, potassium, and sodium were not included as COPCs.

6.3 Exposure Assessment

The exposure assessment addresses each potential exposure pathway via soil (surface and subsurface), groundwater, surface water, sediment, biota, and air. To determine if human exposure via these pathways may occur in the absence of remedial action, an analysis including the identification and characterization of exposure pathways was conducted. The following four elements were examined to determine if a complete exposure pathway was present:

- 1) a source and mechanism of chemical release
- 2) an environmental transport medium
- 3) a feasible receptor exposure route
- 4) a receptor exposure point

The exposure scenarios presented in the following sections are used to estimate individual risks. Unless otherwise noted, all the statistical data associated with the factors used in the dose evaluation equations for assessing exposure were obtained from the Exposure Factors Handbook (USEPA, 1989a) and the accompanying guidance manuals. A reasonable maximum exposure (RME) scenario was utilized in this assessment, which is consistent with USEPA Region IV recommendations regarding human health risk assessment. As a result, the exposure scenarios presented include RME assumptions for the input parameters in the dose evaluation equations. These values are summarized in Table 6-9.

6.3.1 Potential Human Receptors and Adjacent Populations

The following sections provide a discussion of the potential exposure pathways and receptors at Site 36.

6.3.1.1 Site Conceptual Model for Site 36

A site conceptual model of potential sources, migration pathways and human receptors was developed to encompass all current and future potential routes of exposure at the site. This document is presented in Appendix S. Figure 6-1 presents the potential exposure pathways and receptors for Site 36. Qualitative descriptions of current and future land use patterns in the vicinity of OU No.6 were provided in the model. All available analytical data and meteorological data were considered in addition to general understanding of the demographics of surrounding communities.

From this information, the following general list of potential receptors was developed for inclusion in the quantitative health risk analysis for Site 36:

- Current military personnel
- Current trespassers (child [age 1-6 years] and adult)
- Current and future recreational fisherman
- Future on-site residents (child [age 1-6 years] and adult)
- Current and future construction worker

The following sections present a discussion of the potential exposure pathways and receptors at Site 36.

6.3.1.2 Current and Future Scenarios

At present, the site is used for military training exercises and recreation (i.e., fishing, wading, jogging, etc.) for military personnel and their families. It is reasonably assumed that outdoor recreational activities associated with the site, such as jogging and fishing, primarily occur during the summer months. Dirt roads are located throughout the site, which may contribute to fugitive dust generation from vehicular traffic. The majority of the site is heavily wooded and vegetated. Access to the site is not limited. Consequently, trespassing onto the site is feasible.

Current receptors include on-site military personnel, off-site trespassers from nearby residences (i.e., child [1 to 6 years old] and adult receptors), construction workers, and fishermen. For military receptors and trespassers, potential exposure pathways are surface soil incidental ingestion, dermal contact and inhalation of fugitive dust, and surface water and sediment incidental ingestion and dermal contact while wading or playing in the surrounding surface water. Fishermen were similarly evaluated for surface water and sediment exposure via incidental ingestion and dermal contact. These receptors were also assessed for exposure to contaminants in fish and crab tissue via ingestion. Presently, a pipeline is being installed on the eastern portion of Site 36, so current surface soil exposure was evaluated for construction workers. Workers are exposed to subsurface soil when it is excavated during ground breaking for construction activities. Therefore, exposure to surface and subsurface soil in the future case was evaluated.

At present, groundwater at the site is not used for potable purposes. Potable water for the site is supplied by the base treatment facilities via water supply wells. There are no potable wells located within a mile radius of Site 36. Consequently, current exposure to groundwater was not evaluated.

In the future case, it is expected that the site will remain a military restricted area. As stated previously, groundwater is not currently used for potable purposes. It is assumed that this will continue into the future. As a result, groundwater exposure was not assessed for future military personnel. Although it is unlikely that a future residence will be implemented at this site, in accordance with conservative guidance, it is assumed that a private well will be installed on-site in the future case. Consequently, groundwater exposure to a future residential child and adult receptor was assessed. The potential groundwater exposure pathways are ingestion, dermal contact and inhalation while showering. Exposure to surface soil, subsurface soil, surface water, and sediment were also assessed for these receptors.

6.3.2 Migration Exposure Pathways

In general, the migration of COPCs from site soil sources could potentially occur by the following routes:

- Vertical migration of potential contaminants from surficial soils to subsurface soils.
- Leaching of potential contaminants from subsurface soils to the water-bearing zones.
- Vertical migration from shallow water-bearing zones to deeper flow systems.
- Horizontal migration in groundwater in the direction of groundwater flow.
- Groundwater discharge into local streams.
- Wind erosion and subsequent deposition of windblown dust.

The potential for a constituent to migrate spatially and persist in environmental media is important in the estimation of potential exposure. This section describes the potential exposure pathways presented on Figure 6-1 associated with each medium and each potential human receptor group, then qualitatively evaluates each pathway for further consideration in the quantitative risk analysis. Table 6-10 presents the potential human exposure scenarios for this site.

6.3.2.1 Surface Soil

The potential release source considered in the soil pathway was the chemical residuals in the surface soils. The release mechanisms considered were volatilization, fugitive dust generation/deposition, leaching, and surface runoff. The transport media were the surface soils and air. The routes for human exposure to the contaminated soils included inhalation, ingestion, and dermal contact. Potential exposure points from the site were areas of human activity on and adjacent to the site.

Soil Ingestion and Dermal Contact

Incidental ingestion and dermal contact with surface soil in the current case are complete exposure pathways at Site 36. These exposure pathways were evaluated for the current military receptor and trespassers.

Soil Inhalation Via Volatilization

Surface soil represents a potential source of exposure at the site via volatilization of organic COPCs. The potentially exposed population includes current military personnel who may inhale contaminated air. However, no VOCs were identified as COPCs in either media at the site. Air was not sampled at the site. This pathway is not considered to be significant for the site and was not evaluated for the surface soils.

Soil Inhalation Via Fugitive Dust Generation

The surface soils in the current case and the subsurface soils in the future case represent a potential source of exposure at the site via fugitive dust generation from wind erosion and vehicular traffic on surface soils. Current military personnel, trespassers, future residents, and a construction worker may inadvertently inhale the contaminated particulates as dust while engaging in outdoor activities.

6.3.2.2 Subsurface Soil

The potential release source considered in the subsurface soil pathway was the chemical residuals in the contaminated soils. The release mechanism considered was leaching to groundwater. The transport medium was the groundwater infiltrating the subsurface soil. Therefore, exposure to subsurface soils would be indirect (i.e., leaching of contaminants to groundwater). As such, subsurface soil exposure was addressed in the groundwater pathway analysis. Additionally, subsurface soil exposure was mentioned as part of the soil medium. It was assumed that the subsurface soil would be excavated and used as surface grading, landscaping, etc., in the foreseeable future. As a result, exposure to subsurface soil via ingestion, dermal contact, and inhalation was evaluated for the construction worker and residential child and adult receptors. It was assumed that this exposure would result from outdoor activities.

6.3.2.3 Groundwater

The potential release source considered in evaluating the groundwater pathway was contaminated soils. The release mechanism considered was soil leaching. The transport medium was the groundwater. The routes considered for human exposure to the groundwater were direct ingestion of groundwater, dermal contact during showering, and inhalation of volatilized contaminants during showering.

Residences located on-site in the future scenario were considered to be potential exposure points. At present, on-site groundwater is not potable. As a result, groundwater from on-site sources is not significant and was not evaluated for potential risk in the current scenario. In the future scenario, it is conservatively assumed that a potable well will be installed on-site. However, as stated previously, it is not expected that this residential scenario will be implemented in the future at these military sites. As a result, future groundwater risks on-site were assessed conservatively in accordance with guidance.

6.3.2.4 Surface Water

Potential release sources considered in evaluating the surface water pathway were the contaminated soils and groundwater. The release mechanisms considered were surface runoff and groundwater seepage. The transport medium was the surface water. The potential routes considered for human

exposure to the contaminated surface water were incidental ingestion and dermal contact. Potential exposure points were areas of human activity on and adjacent to the site.

At Site 36, children and adults, particularly the fisherman, were evaluated for oral and dermal exposure to the surface water from the creek and the unnamed tributary while wading/playing during outdoor recreation.

6.3.2.5 Sediment

The chemical residuals in the contaminated soils and groundwater are the potential release sources to be considered in the sediment pathway. The routes for human exposure to the contaminated sediments by the sediment pathway include ingestion and dermal contact. Potential exposure points from the site are areas of human activity adjacent to the site.

The receptors previously described for the evaluation of the surface water exposure pathways were assumed to also come in contact with the underlying sediment while wading/playing during outdoor activities. Consequently, the receptors identified for the surface water exposure pathway were also evaluated for exposure to sediment in the current and future scenarios.

6.3.2.6 Air

There are two potential release mechanisms to be considered in evaluating the atmospheric pathway: Release of contaminated particulates (i.e., fugitive dust generation) and volatilization of contaminants from soil and groundwater. The transport mechanism is the air, and the potential exposure points are the areas of human activity on and adjacent to the site.

Fugitive Dust Generation

This air pathway was evaluated as a source of exposure outdoors at the site via fugitive dust generation of contaminants. Air exposure may occur when surface soils become airborne due to wind erosion or vehicular traffic. It is assumed that military personnel, child and adult receptors, and the construction worker may inhale soil particulates while engaging in outdoor activities. This is applicable for both the current and future cases. This exposure pathway was previously assessed for surface and subsurface soil, in Sections 6.3.2.1 and 6.3.2.2, respectively.

Volatilization

The air pathway, specifically, volatilization of contaminants from groundwater, is a source of exposure at Site 36. It is assumed in the future scenario that an adult and child receptor will inhale volatilized contaminants present in groundwater while showering. This pathway was previously discussed for both surface soil and groundwater in Sections 6.3.2.1 and 6.3.2.3, respectively.

6.3.2.7 Aquatic Biota

The potential release sources to be considered in evaluating exposure via fish and crab consumption are contaminated surface water and sediments. Fish and crabs can uptake contaminants present in these media by bioaccumulation and biomagnification. The exposure route for human receptors is ingestion.

At Site 36, only the recreational fisherman was evaluated for potential risk from fish and crab tissue ingestion. The tissue samples collected from the creek were used in this evaluation.

6.3.3 Quantification of Exposure

The concentrations used in the estimation of chronic daily intakes (CDIs) must be representative of the type of exposure being considered. Exposure to groundwater, sediments, and surface waters can occur discretely or at a number of sampling locations. These media are transitory in that concentrations change frequently over time. Averaging transitory data obtained from multiple locations is difficult and requires many more data points at discrete locations than exist within this site. As a result, the best way to represent groundwater, sediment, and surface water contaminants from an exposure standpoint is to use a representative exposure concentration. Soils are less transitory than the aforementioned media and in most cases, exposure occurs over a wider area (i.e., residential exposure). Therefore, an upper confidence interval was used to represent a soil exposure concentration. Soil data collected from each of these areas was used separately in estimating the potential human health risks under current and future exposure scenarios. The human health assessment for future groundwater use considered groundwater data collected from all of the monitoring wells within a site and estimated risks to individuals per area of concern.

The manner in which environmental data are represented depends on the number of samples and sampling locations available for a given area and a given medium. Ninety-fifth percent (95%) upper confidence limit (UCL) values of the arithmetic mean for a lognormal distribution were used as exposure point concentrations for surface, subsurface soil, groundwater, surface water, and sediment. The 95 percent UCL for the lognormal distribution was used rather than the normal distribution, since the former is generally more conservative than the latter. For exposure areas with limited amounts of data or extreme variability in measured data, the 95 percent UCL can be greater than the maximum measured concentration; therefore, in cases where the 95 percent UCL for a contaminant exceeds the maximum detected value in a given data set, the maximum result was used in the estimate of exposure of the 95 percent UCL. However, the true mean may still be higher than this maximum value (i.e., the 95 percent UCL indicates a higher mean is possible), especially if the most contaminated portion of the site has not been sampled.

The 95 percent UCL of the lognormal distribution was calculated using the following equation (USEPA, 1992b):

$$UCL = e^{(\bar{x} + sH/\sqrt{n-1})}$$

Where:

UCL	=	upper confidence limit
e	=	constant (base of the natural log, equal to 2.718)
x	=	mean of the transformed data
s	=	standard deviation of the transformed data
H	=	H-statistic
n	=	number of samples

The following criteria were used to calculate media-specific average concentrations for each parameter that was detected at least once:

- For results reported as "non-detect" (e.g., ND, U, etc.), a value of one-half of the sample-specific detection limit was used to calculate the mean. The use of one-half the detection limit commonly is assigned to non-detects when averaging data for risk assessment purposes, since the actual value could be between zero and a value just below the detection limit.
- Reported concentrations that were less than the detection limit were used to calculate the mean. Typically, these values are qualified with a "J" meaning that the value was estimated.
- The organic analytical results qualified with a "B" were not retained in the data set. The "B" qualifier means that the detected concentration was less than either five times or ten times the blank concentration (i.e., the 5-10 rule), depending upon the parameter. Common laboratory contaminants, such as phthalate esters, toluene, methylene chloride, methyl ethyl ketone, and acetone, follow the five times rule, while other all parameters follow the ten times rule (USEPA, 1989).
- Reported concentrations qualified with "R" were excluded from the data set. The data flag "R" means that the QA/QC data indicated that analytical results were not usable for quantitative purposes.

The reduced data were summarized by medium and analytical parameter type (i.e., organics and inorganics) for the site. For each parameter detected during the sampling programs, the frequency of detection, maximum concentration, minimum concentration, average (arithmetic mean) concentration, and both the normal and lognormal upper 95 percent level for the arithmetic average were summarized. This information is presented in Appendix I. It should be noted that the number of times analyzed may differ per parameter per media per area of concern. This is primarily due to rejected data that were excluded from the data set. Consequently, these data are not reflected in the number of times analyzed. Data and frequency summaries and statistical summaries are presented in Appendices H and I, respectively.

To estimate exposure from the inhalation of volatile contaminants in groundwater while showering, the "Integrated Household Exposure Model for Use of Tap Water Contaminated with Volatile Organic Chemicals," developed by S.A. Foster and P.C. Chrostowski (1987), was applied. To evaluate the health effects of lead, the USEPA lead uptake/biokinetic model was used. The model addresses the lowest age groups because children are exceptionally sensitive to the adverse effects of lead. These models are presented in Appendices Q and R.

6.3.4 Calculation of Chronic Daily Intakes

In order to numerically estimate the risks for current and future human receptors at Site 36, a CDI must be estimated for each COPC in every retained exposure pathway. Appendix T contains the specific CDI equations for each exposure scenario of interest. These equations were obtained from USEPA guidance (USEPA, 1989).

The following paragraphs present the general equations and input parameters used in the calculation of CDIs for each potential exposure pathway. Input parameters were taken from USEPA's default

exposure factors guidelines where available and applicable. All inputs not defined by USEPA were derived from USEPA documents concerning exposure or from best professional judgment. All exposure assessments incorporate the representative contaminant concentrations in the estimation of intakes. Therefore, only one exposure scenario was developed for each exposure route/receptor combination.

CDIs calculated for carcinogenic effects incorporate terms to represent the exposure duration (years) over the course of a lifetime (70 years, or 25,550 days). CDIs for noncarcinogenic effects, on the other hand, were estimated using the concept of an average annual exposure. The intake incorporates terms describing the exposure time and/or frequency representing the number of hours per day and the number of days per year that exposure occurs. In general, noncarcinogenic risks for many exposure routes (e.g., soil ingestion) are greater for children than adults because of the differences in body weights, similar exposure frequencies, and higher ingestion rates.

Future residential exposure scenarios consider 1 to 6 year old children weighing 15 kg and adults weighing 70 kg on average. For current military personnel, an exposure duration of 4 years was used to estimate a military residence. A one-year duration was used for future construction worker exposure scenarios.

6.3.4.1 Incidental Ingestion of Soil

The CDI for COPCs detected in soil was estimated for all potential human receptors and was expressed as:

$$CDI = \frac{C \times IR \times CF \times Fi \times EF \times ED}{BW \times AT}$$

Where:

C	=	Contaminant concentration in soil (mg/kg)
IR	=	Ingestion rate (mg/day)
Fi	=	Fraction ingested from source (dimensionless)
CF	=	Conversion factor (1×10^{-6} kg/mg)
EF	=	Exposure frequency (days/year)
ED	=	Exposure duration (years)
BW	=	Body weight (kg)
AT	=	Averaging time (days)

The following paragraphs discuss the exposure assumptions used in the estimation of exposure to COPCs associated with the potential ingestion of soils.

Military Personnel

During the course of daily activities at Site 36, military personnel could potentially be exposed to COPCs by the incidental ingestion of surface soils. The IR for military personnel exposed to surficial soils was assumed to be 100 mg/day (USEPA, 1989) and 100 percent of the exposure was assumed to be with facility soils containing COPCs. An exposure frequency (EF) of 250 days per year was used in conjunction with an exposure duration of 4 years. An averaging time (AT) of 70 years or 25,550 days was used for exposure to potentially carcinogenic compounds while an

averaging time of 1,460 (4 years x 365 days/year) days was used for noncarcinogenic exposures. An adult average body weight (BW) of 70 kg was used (USEPA, 1989).

Trespassers

Current trespassers could potentially be exposed to COPCs in the surficial soils while outdoors. Children and adults could potentially be exposed to COPCs in soils by incidental ingestion via hand to mouth contact. Ingestion rates (IR) for adults and children in this scenario were assumed to be 100 mg/day and 200 mg/day, respectively. EFs for the receptor groups were assumed to be 130 days per year (child) and 43 days/year (adult). The exposure duration (ED) was 6 years (child) and 30 years (adult). Averaging times of 25,550 days for potential carcinogens and 10,950 days (30 years x 365 days/year) for noncarcinogenic constituents were used for estimating potential CDIs for adults. An AT of 2,190 days (6 years x 365 days/year) was used to estimate potential CDIs for children potentially exposed to noncarcinogens.

Future On-Site Residents

Future on-site residents could potentially be exposed to COPCs in the surficial soils (i.e., the subsurface soil in the future case) during recreational or landscaping activities around their homes. Children and adults could potentially be exposed to COPCs in soils by incidental ingestion via hand to mouth contact. Ingestion rates (IR) for adults and children in this scenario were assumed to be 100 mg/day and 200 mg/day, respectively. EFs for both receptor groups were assumed to be 350 days per year. The residential exposure duration (ED) was divided into two parts. First, a six-year exposure duration was evaluated for young children which accounts for the period of highest soil ingestion (200 mg/day), and second a 30-year exposure was assessed for older children and adults by using a lower soil ingestion rate (100 mg/day) (USEPA, 1991). The BW for a resident child was assumed to be 15 kg, representing younger individuals. The rationale was that the younger child (1 to 6 years), as a resident, will have access to affected on-site soils. The body weight for the future resident adult is assumed to be 70 kg. Averaging times of 25,550 days for potential carcinogens and 10,950 days (30 years x 365 days/year) for noncarcinogenic constituents was used for estimating potential CDIs for adults. An AT of 2,190 days (6 years x 365 days/year) was used to estimate potential CDIs for children potentially exposed to noncarcinogens.

Construction Worker

During excavation activities, construction workers may be exposed to COPCs through the incidental ingestion of subsurface soil. The IR for future construction workers exposed to subsurface soils was assumed to be 480 mg/day (USEPA, 1991). An exposure frequency of 90 days per year was used in conjunction with an exposure duration of one year (USEPA, 1991). An adult BW of 70 kg was used.

A summary of the exposure factors used in the estimation of soil CDIs associated with incidental ingestion is presented in Table 6-9.

6.3.4.2 Dermal Contact with Soil

Chronic daily intakes associated with potential dermal contact of soils containing COPCs were expressed using the following equation:

$$CDI = \frac{C \times CF \times SA \times AF \times ABS \times EF \times ED}{BW \times AT}$$

Where:

C	=	Contaminant concentration in soil (mg/kg)
CF	=	Conversion factor (kg/mg)
SA	=	Skin surface available for contact (cm ²)
AF	=	Soil to skin adherence factor (1.0 mg/cm ²)
ABS	=	Absorption factor (dimensionless) - 0.01 for organics, 0.001 inorganics (USEPA, Region IV, 1992a and 1992d)
EF	=	Exposure frequency (days/year)
ED	=	Exposure duration (years)
BW	=	Body weight (kg)
AT	=	Averaging time (days)

The following paragraphs discuss the exposure assumptions used in the estimation of exposure to COPCs from dermal contact with soils.

Military Personnel

There is a potential for base personnel to absorb COPCs by dermal contact. The exposed skin surface area (4,300 cm²) was limited to the head (1,180 cm²), arms (2,280 cm²), and hands (840 cm²) (USEPA, 1992). Values for exposure duration (ED), exposure frequency (EF), body weight (BW), and averaging time (AT) were the same as those used for the incidental ingestion of soil scenario. The values for AF and ABS were provided above and are in accordance with USEPA and Region IV guidance.

Trespassers

Current trespassers could also be potentially exposed to COPCs in on-site soil through dermal contact experienced during activities near their homes. Skin surface areas (SA) used in this exposure scenario were developed for a reasonable worst case scenario for an individual wearing a short-sleeved shirt, shorts, and shoes. The exposed skin surface area was limited to the head, hands, forearms, and lower legs. Thus, applying 25 percent of the mean total body surface area results in a default of 5,000 cm² for adults. The exposed skin surface for a child (2,000 cm²) was estimated using the 50th (0.866 m²) percentile body surface for a six year old child multiplied by 25 percent (USEPA, 1992). Exposure duration, exposure frequencies, body weights, and averaging times were the same as those discussed for the incidental ingestion scenario presented previously. The values for AF and ABS were provided above and are in accordance with USEPA and Region IV guidance.

Future On-Site Residents

Future on-site residents could also be potentially exposed to COPCs in on-site soil through dermal contact experienced during activities near their homes. Skin surface areas (SA) used in the on-site resident exposure scenario were developed for a reasonable worst case scenario for an individual wearing a short-sleeved shirt, shorts, and shoes. The exposed skin surface area was limited to the head, hands, forearms, and lower legs. Thus, applying 25 percent of the upper bound total body

surface area results in a default of 5,800 cm² for adults. The exposed skin surface for a child (2,300 cm²) was estimated using an average of the 50th (0.866 m²) and the 95th (1.06 m² percentile body surface for a six year old child multiplied by 25 percent (USEPA, 1992). Exposure duration, exposure frequencies, body weights, and averaging times were the same as those discussed for the incidental ingestion scenario presented previously. The values for AF and ABS were provided above and are in accordance with USEPA and Region IV guidance.

Construction Worker

Dermal contact with subsurface soil COPCs could potentially occur during excavation activities. Skin surface area (SA) used for the construction worker exposure scenario were developed for an individual wear a short-sleeved shirt, long pants, and boots. The exposed skin surface area (4,300 cm²) was limited to the head (1,180 cm²), arms (2,280 cm²), and hands (840 cm²) (USEPA, 1992). The exposure frequency and exposure duration are the same as those discussed for incidental ingestion of subsurface soil. The values for AF and ABS were provided above and are in accordance with USEPA and Region IV guidance.

A summary of the soil exposure assessment input parameters for dermal contact is presented in Table 6-9.

6.3.4.3 Inhalation of Fugitive Particulates

Exposure to fugitive particulates was estimated for most of the receptors, i.e., military personnel, trespassers, fishermen, future residents, and construction workers. These populations may be exposed during daily recreational or work-related activities. The chronic daily intake of contaminants associated with the inhalation of particulates was estimated using the following equation:

$$CDI = \frac{C \times IR \times EF \times ED \times 1/PEF}{BW \times AT}$$

Where:

C	=	Contaminant concentration in soil (mg/kg)
IR	=	Inhalation rate (m ³ /day)
EF	=	Exposure frequency (days/year)
ED	=	Exposure duration (years)
1/PEF	=	Particulate emission factor 1/(1.32x10 ⁹) (m ³ /kg)
BW	=	Body weight (kg)
AT	=	Averaging time (days)

The PEF relates the concentration in soil with the concentration of respirable particles in the air from fugitive dust emission. This relationship is derived by Cowherd (1985). The particulate emissions from contaminated sites are caused by wind erosion, and, therefore, depend on erodibility of the surface material. The PEF value was obtained from a telephone conversation with Janine Dinan of USEPA (USEPA, 1995c).

The following paragraphs discuss the exposure assumptions used in the estimation of exposure to COPCs from the inhalation of particulates.

Military Personnel

During work related activities, military personnel may inhale COPCs emitted as fugitive dust. An inhalation rate 30 m³/day was used for military personnel (USEPA, 1991). Values for exposure duration, exposure frequency, body weight, and averaging time were the same as those used for the incidental ingestion scenario.

Trespassers

Trespassers may also inhale particulates. Inhalation rates (IR) used in this exposure scenario were 20 m³/day and 15 m³/day for adults and children, respectively (USEPA, 1989). Exposure frequencies, duration, body weights, and averaging time were the same as those used for the incidental ingestion scenario. Table 6-9 presents the exposure factors used to estimate CDIs associated with the particulate inhalation scenario.

Future On-Site Residents

Future on-site residents may also inhale particulates. Inhalation rates (IR) used in the on-site resident exposure scenario were 20 m³/day and 15 m³/day for adults and children, respectively (USEPA, 1989). Exposure frequencies, duration, body weights, and averaging time were the same as those used for the incidental ingestion scenario. Table 6-9 presents the exposure factors used to estimate CDIs associated with the particulate inhalation scenario.

Construction Worker

Construction workers could become exposed to subsurface soil particulates during excavation activities. The inhalation rate (IR) used was 20 m³/day (USEPA, 1989). Exposure frequencies, duration, body weight, and averaging time were the same as those used for the soil incidental ingestion scenario. Table 6-9 presents the exposure factors used to estimate CDIs associated with the particulate inhalation scenario.

6.3.4.4 Ingestion of Groundwater

As stated previously, shallow groundwater is not currently being used as a potable supply at Site 36. Development of the shallow aquifer for potable use is unlikely because of its general water quality and poor flow rates. However, residential housing could be constructed in the future and groundwater used for potable purposes.

The CDI of contaminants associated with the future potential consumption of groundwater was estimated using the following general equation:

$$CDI = \frac{C \times IR \times EF \times ED}{BW \times AT}$$

Where:

C	=	Contaminant concentration in groundwater (mg/L)
IR	=	Ingestion rate (L/day)
EF	=	Exposure frequency (days/year)
ED	=	Exposure duration (years)

BW = Body weight (kg)
 AT = Averaging time (days)

The following paragraphs discuss the exposure assumptions used in the estimation of exposure to COPCs from the ingestion of groundwater.

Future On-Site Residents

Exposure to COPCs via ingestion of groundwater was retained as a potential future exposure pathway for both children and adults. An IR of 1.0 L/day was used for the amount of water consumed by a 1 to 6 year old child weighing 15 kg. The IR was 2 L/day for the adult receptor. This ingestion rate provides a conservative exposure estimate (for systemic, noncarcinogenic toxicants) designed to protect young children who may be more affected than adolescents, or adults. This value assumes that children obtain all the tap water they drink from the same source for 350 days/year (which represents the exposure frequency [EF]). An averaging time (AT) of 2,190 days (6 years x 365 days/year) is used for noncarcinogenic compound exposure. The ingestion rate (IR) for adults was 2 liters/day (USEPA, 1989a). The ED used for the estimation of adult CDIs was 30 years (USEPA, 1989), which represents the national upper-bound (90th percentile) time at one residence. The averaging time for noncarcinogens was 10,950 days. An averaging time (AT) of 25,550 days (70 years x 365 days/year) was used to evaluate exposure for both children and adults to potential carcinogenic compounds. Table 6-9 presents a summary of the input parameters for the ingestion of groundwater scenarios.

6.3.4.5 Dermal Contact with Groundwater

The CDI associated with the dermal contact with groundwater was estimated using the following general equation:

$$CDI = \frac{C \times SA \times PC \times ET \times EF \times ED \times CF}{BW \times AT}$$

Where:

C = Contaminant concentration in groundwater (mg/L)
 SA = Surface area available for contact (cm²)
 PC = Dermal permeability constant (cm/hr)
 ET = Exposure time (hour/day)
 EF = Exposure frequency (days/year)
 ED = Exposure duration (years)
 CF = Conversion factor (1 L/1000 cm³)
 BW = Body weight (kg)
 AT = Averaging time (days)

The following paragraphs discuss the exposure assumptions used in the estimation of exposure to COPCs from dermal contact with groundwater.

Future On-Site Residents

Children and adults could contact COPCs through dermal contact with groundwater while bathing or showering. It was assumed that bathing would take place 350 days/year using site groundwater

as the sole source. The whole body skin surface area (SA) available for dermal absorption was estimated to be 10,000 cm² for children and 23,000 cm² for adults (USEPA, 1992). The permeability constant (PC) reflects the movement of a chemical across the skin and into the blood stream. The permeability of a chemical is an important property in evaluating actual absorbed dose, yet many compounds do not have literature PC values. For contaminants in which a PC value has not been established, the permeability constant was calculated (see Appendix Q). An exposure time (ET) of 0.25 hour/day was used to conservatively estimate the duration of bathing or showering. The exposure duration, body weight, and averaging time were the same as those used for the ingestion of groundwater scenario. Table 6-9 presents the exposure factors used to estimate CDIs associated with the future dermal contact with COPCs in groundwater.

6.3.4.6 Inhalation of Volatile Organics While Showering

In order to quantitatively assess the inhalation of contaminants volatilized from shower water, the model developed by Foster and Chrostowski (Foster, 1987) was utilized. Contaminant concentrations in air were modeled by estimating the following: the rate of chemical releases into air (generation rate), the buildup of VOCs in the shower room air while the shower was on, the decay of VOCs in the shower room after the shower was turned off, and the quantity of airborne VOCs inhaled while the shower was both on and off. The contaminant concentrations calculated to be in the air were then used as the concentration term.

The CDIs associated with the inhalation of airborne (vapor phase) VOCs from groundwater while showering were estimated using the following general equation:

$$CDI = \frac{C \times IR \times ET \times EF \times ED}{BW \times AT}$$

Where:

C	=	Contaminant concentration in air (mg/m ³)
IR	=	Inhalation rate (m ³ /hr)
ET	=	Exposure time (hr/day)
EF	=	Exposure frequency (days/year)
ED	=	Exposure duration (years)
BW	=	Body weight (kg)
AT _c	=	Averaging time carcinogen (days)
AT _{nc}	=	Averaging time noncarcinogen (days)

Future On-Site Residents

Both children and adults could inhale vaporized volatile organic COPCs during showering. It was assumed that showering would take place 350 days/year, using site groundwater as the sole source, for children weighing 15 kg, and adults weighing 70 kg (USEPA, 1989). An inhalation rate of 0.6 m³/hr was used for both receptors (USEPA, 1989). An exposure time of 0.25 hrs/day was used for both receptors (USEPA, 1989). The exposure duration and averaging times remained the same as for groundwater ingestion. Table 6-9 presents the exposure factors used to estimate CDIs associated with the inhalation of VOCs from groundwater while showering.

6.3.4.7 Incidental Ingestion of Surface Water

The CDIs for contaminants associated with incidental ingestion of surface water were expressed using the following equation:

$$CDI = \frac{C \times IR \times ET \times EF \times ED}{BW \times AT}$$

Where:

C	=	Contaminant concentration in surface water (mg/L)
IR	=	Ingestion rate (L/day)
ET	=	Exposure time (hours/day)
EF	=	Exposure frequency (days/year)
ED	=	Exposure duration (years)
BW	=	Body weight (kg)
AT	=	Averaging time (days)

The following paragraphs discuss the exposure assumptions used in the estimation of exposure to COPCs from the incidental ingestion of surface water.

Current and Future Children and Adults

Adults and children (i.e., residents and trespassers) who may potentially come into contact with the surface water while wading/playing were assumed to conservatively ingest surface water at a rate of 0.005 L/hour (USEPA, 1989). In addition, an exposure frequency (EF) of 45 days/year (9 days/month x 5 months), an ET of 2.6 hours/day and an exposure duration (ED) of 6 years (age 1-6) for a child, and 30 years for an adult were used (USEPA, 1989).

Current and Future Fisherman

A fisherman may potentially come into contact with the surface water while recreational wading/fishing was assumed to conservatively ingest surface water at a rate of 0.005 L/hour, (USEPA, 1989). In addition, an exposure frequency (EF) of 48 days/year (USEPA, 1989), an ET of 2.6 hours/day, and an exposure duration (ED) of 30 years were used.

A summary of the surface water exposure factors associated with incidental ingestion of surface water is presented in Table 6-9.

6.3.4.8 Dermal Contact with Surface Water

The CDIs of contaminants associated with dermal contact of surface water were determined using the following general equation:

$$CDI = \frac{C \times SA \times PC \times ET \times EF \times ED \times CF}{BW \times AT}$$

Where:

C	=	Contaminant concentration in surface water (mg/L)
CF	=	Conversion factor (0.001L/cm ³)
SA	=	Surface area available for contact (cm ²)
PC	=	Chemical-specific dermal permeability constant (cm/hr)
ET	=	Exposure time (hour/day)
EF	=	Exposure frequency (days/year)
ED	=	Exposure duration (years)
BW	=	Body weight (kg)
AT	=	Averaging time (days)

The following paragraphs discuss the exposure assumptions used in the estimation of exposure to COPCs from dermal contact with surface water.

Current and Future Children and Adults

The SA for adults and children who may potentially come into contact with the surface water while recreational wading/playing during outdoor recreational activities was assumed to be 5,800 and 2,300 cm², respectively, as previously described in the soil exposure scenario. In addition, an exposure frequency (EF) of 45 days/year (9 days/month x 5 months) and an exposure duration (ED) of 6 years (age 1-6) for a child, and 30 years for an adult were used (USEPA, 1989). It was conservatively assumed that 2.6 hours/day would be the exposure time for these receptors. The values for PC were chemical-specific. For COPCs with no PC values available, the values were calculated (see Appendix Q).

Current and Future Fisherman

The SA for the fisherman who may potentially come into contact with the surface water while recreational fishing/wading was assumed to be 5,800 cm². In addition, an exposure frequency (EF) of 48 days/year and an exposure duration (ED) of 30 years for an adult were used (USEPA, 1989). The ET of 2.6 hours/day was also used for this receptor. Exposure time, frequency, and duration were the same as for the surface water ingestion scenario. The values for PC were chemical-specific. For COPCs with no PC available, the value was calculated (see Appendix Q). The exposure factors for this potential exposure pathway are summarized in Table 6-9.

6.3.4.9 Incidental Ingestion of Sediment

The CDI of COPCs associated with the incidental ingestion of sediment was expressed using the following general equation:

$$CDI = \frac{C \times IR \times EF \times ED \times CF}{BW \times AT}$$

Where:

C	=	Contaminant concentration in sediment (mg/kg)
CF	=	Conversion factor (kg/mg)
IR	=	Ingestion rate of sediment (mg/day)
EF	=	Exposure frequency (days/year)

ED	=	Exposure duration (years)
BW	=	Body weight (kg)
AT	=	Averaging time (days)

The following paragraphs discuss the exposure assumptions used in the estimation of exposure to COPCs from incidental ingestion of sediments.

Current and Future Children and Adults

Incidental ingestion of COPCs in sediments is also possible during wading/playing in the surface water bodies at Site 36. An ingestion rate (IR) of 100 mg/day was used in calculating the chronic daily intake for children and adults. The exposure frequency (EF) of 45 days/year (9 days/month x 5 months) was used as a conservative site-specific assumption. An exposure duration (ED) of 6 years and 30 years was used in the estimation of potential COPCs for a child and adult, respectively.

Current and Future Fisherman

Incidental ingestion of COPCs in sediments is also possible during recreational fishing activities in the surface water bodies at Site 36. An ingestion rate (IR) of 100 mg/day was used in calculating the chronic daily intake for children and adults. The exposure frequency (EF) of 48 days/year was used. An exposure duration (ED) of 30 years was used. A summary of exposure factors for this scenario is presented in Table 6-9.

6.3.4.10 Dermal Contact with Sediment

The CDI of contaminants associated with the dermal contact of affected sediments was expressed using the following general equation:

$$CDI = \frac{C \times SA \times AF \times ABS \times EF \times ED \times CF}{BW \times AT}$$

Where:

C	=	Contaminant concentration in sediment (mg/kg)
CF	=	Conversion factor (1x10 ⁻⁶ kg/mg)
SA	=	Surface area available for contact (cm ² /day)
AF	=	Adherence factor (1.0 mg/cm ²)
ABS	=	Absorption factor (dimensionless) - 0.01 organics, 0.001 inorganics (USEPA, Region IV, 1992a and 1992d)
EF	=	Exposure frequency (days/year)
ED	=	Exposure duration (years)
BW	=	Body weight (kg)
AT	=	Averaging time (days)

The following paragraphs discuss the exposure assumptions used in the estimation of exposure to COPCs from dermal contact with sediment.

Current and Future Children and Adults

Future on-site residents could also be potentially exposed to COPCs in sediment via dermal contact while wading/playing in the surface water. Skin surface areas (SA) used in the resident exposure scenario were developed for a reasonable worst case scenario for an individual wearing a short-sleeved shirt, shorts, and shoes. The exposed skin surface area was limited to the head, hands, forearms, and lower legs. Thus, applying 25 percent of the upper bound total body surface area results in a default of 5,800 cm² for adults. The exposed skin surface for a child (2,300 cm²) was estimated using an average of the 50th (0.866 m²) and the 95th (1.06 m²) percentile body surface for a six year old child multiplied by 25 percent. The child SA was calculated using information presented in USEPA guidance (USEPA, 1992). Exposure duration, exposure frequencies, body weights, and averaging times were the same as those discussed for the surface water exposure scenario presented previously. The values for AF and ABS were provided with the equation and are in accordance with USEPA and Region IV guidance.

Current and Future Fisherman

The exposed skin surface area for the recreational fisherman was limited to the head, hands, forearms, and lower legs. Thus, applying 25 percent of the upper bound total body surface area results in a default of 5,800 cm² for adults. The exposed skin surface for a fisherman was estimated as 5,800 cm². Exposure duration, exposure frequencies, body weight, and averaging times were the same as those discussed for the surface water exposure scenario presented previously. The values for AF and ABS were provided with the equation and are in accordance with USEPA and Region IV guidance. Table 6-9 provides a complete summary of the input parameters used in the estimation of CDIs for this scenario.

6.3.4.11 Aquatic Biota

The CDI associated with the potential ingestion of biota was expressed using the following equation:

$$CDI = \frac{C \times IR \times Fi \times EF \times ED}{BW \times AT}$$

Where:

C	=	Contaminant concentration in fish or crab (mg/kg)
IR	=	Ingestion rate (kg/meal)
Fi	=	Fraction ingested from source(dimensionless)
EF	=	Exposure frequency (meals/year)
ED	=	Exposure duration (years)
BW	=	Body weight (kg)
AT	=	Averaging time (days)

Current and Future Fisherman

The ingestion rate was 0.284 kg/day, which represents the upper 95th percentile consumption rate occurring in conjunction with recreational fishing (USEPA, 1989). The fraction of fish ingested from the source (Fi) for adults was estimated to be 100 percent (1.0) for the 90th percentile consumption rate. The exposure frequency is 48 meals/year (USEPA, 1989). The exposure duration (ED) for adults was set at 30 years, and an averaging time (AT) of 70 years or 25,550 days was used

for exposure to carcinogenic compounds. An AT of 10,950 days was used for exposure to noncarcinogenic COPCs (USEPA, 1989).

These values were also used for crab ingestion. Table 6-9 presents a summary of the exposure factors used for the ingestion of fish and crab scenario.

6.4 Toxicity Assessment

The purpose of this section is to define the toxicological values used to evaluate the exposure to the COPCs identified in Section 6.2.4. A toxicological evaluation characterizes the inherent toxicity of a compound. It consists of the review of scientific data to determine the nature and extent of the potential human health and environmental effects associated with exposure to various contaminants.

Human data from occupational exposures are often insufficient for determining quantitative indices of toxicity because of uncertainties in exposure estimates and inherent difficulties in determining causal relationships established by epidemiological studies. For this reason, animal bioassays are conducted under controlled conditions and their results are extrapolated to humans. There are several stages to this extrapolation. First, to account for species differences, conversion factors are used to extrapolate from test animals to humans. Second, the relatively high doses administered to test animals must be extrapolated to the lower doses more typical of human exposures. For potential noncarcinogens, safety factors and modifying factors are applied to animal results when developing acceptable human doses. For potential carcinogens, mathematical models are used to extrapolate effects at high doses to effects at lower doses. Epidemiological data can be used for inferential purposes to establish the credibility of the experimentally derived indices.

The available toxicological information indicates that many of the COPCs have both potential carcinogenic and noncarcinogenic health effects in humans and/or experimental animals. Although the COPCs may cause adverse health and environmental impacts, dose-response relationships and the potential for exposure must be evaluated before the risk to receptors can be determined. Dose-response relationships correlate the magnitude of the dose with the probability of toxic effects, as discussed in the following section.

An important component of the risk assessment is the relationship between the dose of a compound (amount to which an individual or population is potentially exposed) and the potential for adverse health effects resulting from the exposure to that dose. Dose-response relationships provide a means by which potential public health impacts may be evaluated. The published information on doses and responses is used in conjunction with information on the nature and magnitude of exposure to develop an estimate of risk.

Standard carcinogenic slope factors (CSFs) and/or reference doses (RfDs) have been developed for many of the COPCs. This section provides a brief description of these parameters.

6.4.1 Carcinogenic Slope Factor

CSFs are used to estimate an upper-bound lifetime probability of an individual developing cancer as a result of exposure to a particular level of a potential carcinogen (USEPA, 1989). This factor is generally reported in units of $(\text{mg}/\text{kg}/\text{day})^{-1}$ and is derived through an assumed low-dosage linear multistage model and an extrapolation from high to low dose-responses determined from animal studies. The value used in reporting the slope factor is the upper 95th percent confidence limit.

These slope factors are also accompanied by USEPA weight-of-evidence (WOE) classifications, which designate the strength of the evidence that the COPC is a potential human carcinogen.

In assessing the carcinogenic potential of a chemical, the Human Health Assessment Group (HHAG) of USEPA classifies the chemical into one of the following groups, according to the weight of evidence from epidemiologic and animal studies:

- | | | |
|----------------|---|---|
| Group A | - | Human Carcinogen (sufficient evidence of carcinogenicity in humans) |
| Group B | - | Probable Human Carcinogen (B1 - limited evidence of carcinogenicity in humans; B2 - sufficient evidence of carcinogenicity in animals with inadequate or lack of evidence in humans) |
| Group C | - | Possible Human Carcinogen (limited evidence of carcinogenicity in animals and inadequate or lack of human data) |
| Group D | - | Not Classifiable as to Human Carcinogenicity (inadequate or no evidence) |
| Group E | - | Evidence of Noncarcinogenicity for Humans (no evidence of carcinogenicity in adequate studies) |

6.4.2 Reference Dose

The RfD is developed for chronic and/or subchronic human exposure to chemicals and is based solely on the noncarcinogenic effects of chemical substances. It is defined as an estimate of a daily exposure level for the human population, including sensitive populations, that is not likely to cause an appreciable risk of adverse effects during a lifetime. The RfD is usually expressed as dose (mg) per unit body weight (kg) per unit time (day). It is generally derived by dividing a no-observed-(adverse)-effect-level (NOAEL or NOEL) or a lowest observed-adverse-effect-level (LOAEL) for the critical toxic effect by an appropriate uncertainty factor (UF). Effect levels are determined from laboratory or epidemiological studies. The UF is based on the availability of toxicity data.

UFs usually consist of multiples of 10, where each factor represents a specific area of uncertainty naturally present in the extrapolation process. These UFs are presented below and were taken from the Risk Assessment Guidance Document for Superfund, Volume I, Human Health Evaluation Manual (Part A) (USEPA, 1989):

- A UF of 10 is to account for variation in the general population and is intended to protect sensitive populations (e.g., elderly, children).
- A UF of 10 is used when extrapolating from animals to humans. This factor is intended to account for the interspecies variability between humans and other mammals.
- A UF of 10 is used when a NOAEL derived from a subchronic instead of a chronic study is used as the basis for a chronic RfD.

- A UF of 10 is used when a LOAEL is used instead of a NOAEL. This factor is intended to account for the uncertainty associated with extrapolating from LOAELs to NOAELs.

In addition to UFs, a modifying factor (MF) is applied to each reference dose and is defined as:

- A MF ranging from >0 to 10 is included to reflect a qualitative professional assessment of additional uncertainties in the critical study and in the entire data base for the chemical not explicitly addressed by the preceding uncertainty factors. The default for the MF is 1.

Thus, the RfD incorporates the uncertainty of the evidence for chronic human health effects. Even if applicable human data exist, the RfD still maintains a margin of safety so that chronic human health effects are not underestimated.

Toxicity factors and the USEPA WOE classifications are presented in Table 6-11. The hierarchy (USEPA, 1989) for choosing these values was as follows:

- Health Effects Assessment Summary Table (HEAST, USEPA, 1995)
- Integrated Risk Information System (IRIS, USEPA, 1995a)

The IRIS data base is updated monthly and contains both verified CSFs and RfDs. The USEPA has formed the Carcinogen Risk Assessment Verification Endeavor (CRAVE) Workgroup to review and validate toxicity values used in developing CSFs. Once the slope factors have been verified via extensive peer review, they appear in the IRIS data base. Like the CSF Workgroup, the USEPA has formed a RfD Workgroup to review existing data used to derive RfDs. Once the reference doses has been verified, they also appear in IRIS.

HEAST on the other hand, provides both interim (unverified) and verified CSFs and RfDs. This document is published quarterly and incorporates any applicable changes to its data base.

Toxicity values will be obtained primarily from the Region III Risk-Based Concentration Table, which is based on IRIS, HEAST and provisional and/or recommended USEPA toxicity values, in accordance with Region IV recommendations.

For some chemicals, there are no USEPA-verified toxicity values (i.e., RfDs and CSFs) available for risk quantitation. This is the case for lead. The following section provides a discussion of how lead health effects were quantified for this assessment.

For other chemicals, the toxicity values of similarly structured compounds were substituted. For this site, the chemical substitutes were as follows: endosulfan for endosulfan sulfate, endrin for endrin ketone and endrin aldehyde, chlordane for alpha-chlordane and gamma-chlordane, and PCBs for Aroclor-1248 and Aroclor-1254. In addition, there are some chemicals with different toxicity values associated with the medium in which they are detected. For example, the oral RfD for cadmium differs when found in food or water. Consequently, the oral RfDs associated with food were applied for assessing soil exposure, and the oral RfDs associated with water were used accordingly.

6.4.3 Lead

Lead was identified as a COPC in the surface soil, subsurface soil, sediment, and crab samples collected from Site 36. Currently, health-based criteria are not available for evaluating either the noncarcinogenic or carcinogenic effects of lead exposure. The USEPA has not developed health-based criteria because a threshold level for many noncancer health effects has not been identified in infants and younger children (i.e., the most sensitive populations). Consequently, risk from lead exposure was not calculated for the site.

To evaluate lead at waste sites, the USEPA had developed a lead uptake/biokinetic (UBK) model. This model utilizes site-specific exposure parameters to estimate blood lead levels in infants and young children. The USEPA considers remediation necessary if a 5 percent probability or greater exists that the predicted child blood level will exceed 10 µg/dl as a result of contact with lead-containing media at the site.

There are several criteria available for lead level comparisons in the form of standards, criteria and/or TBCs. These standards/criteria/TBCs include federal and state MCLs and AWQC. In addition, there is an Office of Solid Waste and Emergency Response (OSWER) directive for lead in soil. This value is 400 mg/kg in residential soil. At Site 36, the maximum concentrations of lead found in the soils, surface and subsurface, exceeded this OSWER level. Lead was found frequently in the crab tissue samples. Consequently, the lead UBK model was utilized to evaluate the risk associated with exposure to lead-containing soil and crab tissue at Site 36. While the lead UBK model addresses soil and food ingestion as exposure pathways, it does not consider sediment exposure. Consequently, lead in sediment was not evaluated in the model.

6.4.4 Dermal Adjustment of Toxicity Factors

Because there are few toxicity reference values for dermal exposure, oral values are frequently used to assess risk from dermal exposure. Most RfDs and some slope factors are expressed as the amount of substance administered per unit time and unit body weight, while exposure estimates for the dermal route are expressed as absorbed dose. Consequently, it may be necessary to adjust an oral toxicity value from an administered dose to an absorbed dose.

Region IV provides absorption efficiency values for each class of chemicals. They are as follows:

VOCs	=	0.80
SVOCs	=	0.50
Inorganics	=	0.20
Pesticides/PCBs	=	0.50

An adjusted oral RfD is the product of the absorption efficiency and the oral toxicity reference value. The adjusted oral CSF is the ratio of the oral toxicity value and the absorption efficiency. Table 7-12 presents a summary of the dermally-adjusted toxicity values used in this BRA.

6.5 Risk Characterization

This section presents and discusses the estimated incremental lifetime cancer risks (ICRs) and hazard indices (HIs) for identified potential receptor groups which could be exposed to COPCs via the exposure pathways presented in Section 6.3.2.

These quantitative risk calculations for potentially carcinogenic compounds estimate ICRs levels for an individual in a specified population. This unit risk refers to the cancer risk that is over and above the background cancer risk in unexposed individuals. For example, an ICR of 1×10^{-6} indicates that, for a lifetime exposure, one additional case of cancer may occur per one million exposed individuals.

The ICR to individuals was estimated from the following relationship:

$$ICR = \sum_{i=1}^n CDI_i \times CSF_i$$

where CDI_i is the chronic daily intake (mg/kg/day) for compound i and CSF_i is the cancer slope in $(\text{mg/kg/day})^{-1}$ for contaminant i . The CSF is defined in most instances as an upper 95th percentile confidence limit of the probability of a carcinogenic response based on experimental animal data, and the CDI is defined as the exposure expressed as a mass of a substance contracted per unit body weight per unit time, averaged over a period of time (i.e., six years to a lifetime). The above equation was derived assuming that cancer is a non-threshold process and that the potential excess risk level is proportional to the cumulative intake over a lifetime.

In contrast to the above approach for potentially carcinogenic effects, quantitative risk calculations for noncarcinogenic compounds assume that a threshold toxicological effect exists. Therefore, the potential for noncarcinogenic effects is calculated by comparing CDIs with threshold levels (reference doses).

Noncarcinogenic effects were estimated by calculating the hazard index (HI) which is defined as:

$$HI = HQ_1 + HQ_2 + \dots + HQ_n \text{ or}$$

$$HI = \sum_{i=1}^n HQ_i$$

$$\text{where } HQ_i = CDI_i / RfD_i$$

HQ_i is the hazard quotient for contaminant i , CDI_i is the chronic daily intake (mg/kg/day) of contaminant i , and RfD_i is the reference dose (mg/kg/day) of the contaminant i over a prolonged period of exposure.

6.5.1 Human Health Risks

The following paragraphs present the quantitative results of the human health evaluation for each medium and area of concern at Site 36.

Estimated ICRs were compared to the target risk range of 1×10^{-6} to 1×10^{-4} . USEPA stipulates an acceptable cancer risk level of 10^{-6} to 10^{-4} for total risk at a hazardous waste site. These cancer risk levels represent the probability of an individual developing cancer over his or her lifetime if exposed to the contaminants of concern at the site. For example, a risk level of 10^{-6} is the probability that one person in 1,000,000 exposed persons will develop cancer in a lifetime. Carcinogenic risk levels

greater than 10^{-4} are considered unacceptable. A value of 1.0 was used for examination of the HI. The HI was calculated by comparing estimated CDIs with threshold levels below which, noncarcinogenic health effects are not expected to occur. Any HI equal to or exceeding 1.0 suggested that noncarcinogenic health effects were possible. If the HI was less than 1.0, then systemic human health effects were considered unlikely. Tables 6-13 through 6-19 present these risk results.

6.5.1.1 Current Military Personnel

The current military receptor was evaluated for potential noncarcinogenic and carcinogenic risk from exposure to the surface soil. The noncarcinogenic (i.e., $HI < 0.01$) and carcinogenic risks (i.e., $ICR = 1.2 \times 10^{-6}$) fell below the acceptable risk levels (i.e., $HI < 1$ and $1 \times 10^{-6} < ICR < 1 \times 10^{-4}$). These results are presented in Table 6-13.

6.5.1.2 Current Trespasser Child

In the current scenario, a recreational child receptor was evaluated for potential risk from exposure to site surface soils and surface water and sediment from Brinson Creek and the unnamed tributary. The potential noncarcinogenic and carcinogenic risks from exposure to the surface soil (i.e., $HI = 0.19$ and $ICR = 3.5 \times 10^{-6}$), the surface water (i.e., $HI = 0.04$) and sediment (i.e., $HI = 0.15$ and $ICR = 7.8 \times 10^{-7}$) were within acceptable risk levels (i.e., $HI < 1$ and $1 \times 10^{-6} < ICR < 1 \times 10^{-4}$). The results are summarized in Table 6-14.

6.5.1.3 Future Residential Child

The child receptor was evaluated for potential risk from exposure to soil and groundwater in the future scenario. It was assumed that current exposure to surface water and sediment also would occur in the future case.

The potential risks from exposure to surface soil (i.e., $HI = 0.97$ and $ICR = 1.7 \times 10^{-5}$), subsurface soil (i.e., $ICR = 1.5 \times 10^{-5}$), surface water (i.e., $HI = 0.03$) and sediment (i.e., $HI = 0.16$ and $ICR = 7.9 \times 10^{-7}$) were within acceptable risk levels (i.e., $HI < 1$ and $1 \times 10^{-6} < ICR < 1 \times 10^{-4}$). The noncarcinogenic risk from subsurface soil exposure (i.e., $HI = 2.3$) exceeded the acceptable risk level of one. Iron in subsurface soil contributes to this risk. The results are summarized in Table 6-15.

In groundwater, there is a potential noncarcinogenic risk from ingestion for the child receptor. The noncarcinogenic risk level was 5.2 from groundwater ingestion. This value exceeded the acceptable risk level of one for noncarcinogenic risks. Iron in groundwater contributed to this risk. The risk results are presented in Table 6-15.

6.5.1.4 Current Trespasser Adult

In the current scenario, an adult trespasser was evaluated for potential risk from exposure to site surface soils (i.e., $HI < 0.1$ and $ICR = 1.2 \times 10^{-6}$) and surface water (i.e., $HI = 0.02$), and sediment (i.e., $HI = 0.02$ and $ICR = 5.6 \times 10^{-7}$). The potential noncarcinogenic and carcinogenic risks from exposure to these media were within acceptable risk levels (i.e., $HI < 1$ and $1 \times 10^{-6} < ICR < 1 \times 10^{-4}$). These results are provided in Table 6-16.

6.5.1.5 Future Residential Adult

The adult receptor was evaluated for potential risk from exposure to soil and groundwater in the future scenario. Similar to the child receptor, it was assumed that current exposure to the surface water and sediment also would occur in the future case.

In surface soil (i.e., HI=0.13 and ICR= 1.5×10^{-5}), subsurface soil (i.e., HI=0.3 and ICR= 1.1×10^{-5}), surface water (i.e., HI=0.02) and sediment (i.e., HI=0.02 and ICR= 5.9×10^{-7}), the potential noncarcinogenic and carcinogenic risks from exposure to these media were within acceptable levels (i.e., HI<1 and 1×10^{-6} <ICR< 1×10^{-4}).

In groundwater, the potential noncarcinogenic risk from ingestion does not fall within acceptable risk levels. The potential noncarcinogenic risk from groundwater ingestion was 2.2. Iron contributed to the risk. Table 6-17 is a summary of these results.

6.5.1.6 Current/Future Fisherman

A fisherman receptor was evaluated for risk from exposure to the surface water (i.e., HI=0.02), sediment (i.e., HI=0.022 and ICR= 6.3×10^{-7}), fish tissue (i.e., HI=5.3 and ICR= 5.3×10^{-4}), and crab tissue (i.e., HI=3.8 and ICR= 5.4×10^{-4}). The potential noncarcinogenic and carcinogenic risks from exposure to these media, except the fish and crab tissue, were within acceptable risk levels (i.e., HI<1 and 1×10^{-6} <ICR< 1×10^{-4}). The noncarcinogenic and carcinogenic risk from fish and crab tissue ingestion exceeds the acceptable risk levels of one and 1×10^{-4} . Arsenic and mercury in fish and crab tissue are impacting these risks. Arsenic exhibits both carcinogenic and noncarcinogenic effects. Mercury is a noncarcinogen. These results are provided in Table 6-18.

6.5.1.7 Construction Worker

The construction worker was evaluated for potential noncarcinogenic and carcinogenic risk from exposure to the surface soil in the current case and subsurface soil in the future case. Both noncarcinogenic (i.e., HI=0.13) and carcinogenic risks (i.e., ICR= 3.6×10^{-7}) from exposure to the surface soil for this receptor fell within the acceptable risk levels. Similarly, both noncarcinogenic (i.e., HI=0.3) and carcinogenic risks (i.e., ICR= 3.3×10^{-7}) from exposure to the subsurface soil fell within the acceptable risk levels. Table 6-19 presents these results.

6.6 Lead UBK Model Results

The USEPA lead UBK model was used to determine if exposure to site media would result in unacceptable blood lead levels in younger children upon exposure to the soil at Site 36. Blood lead levels are considered unacceptable when a greater than 5 percent probability exists that the blood lead levels will exceed 10 µg/dl.

The maximum concentrations of lead found in the surface soil (current case), subsurface soil (future case), and crab tissue (current/future case) were used in the model. The remaining model parameters used were the default factors supplied in the model. The maximum concentrations in surface soil (836J mg/kg), subsurface soil (2,680J mg/kg), and crab tissue (0.61 mg/kg) resulted in a greater than 5 percent probability of the blood lead levels exceeding 10 µg/dl, which is not within acceptable levels. Figures 6-2 through 6-7 illustrate these results.

6.7 Sources of Uncertainty

Uncertainties may be encountered throughout the BRA process. This section discusses the sources of uncertainty involved with the following:

- Analytical data
- Exposure Assessment
- Toxicity Assessment
- Compounds Not Qualitatively Evaluated

In addition, the USEPA stresses the importance of recognizing the unique characteristics and circumstances of each facility and the need to formulate site-specific responses. However, many of the assumptions presented in this document were derived from USEPA guidance, which is designed to provide a conservative approach and cover a broad variety of cases. As such, the generic application of such assumptions to a site in the RME case scenario may work against the objective of formulating a site-specific response to a constituent presence (i.e., it is possible that the site risks may be overestimated).

The following sections provide a discussion of the sources of uncertainty associated with this BRA and the effects on total site risk. Table 6-20 is a summary of these sources.

6.7.1 Analytical Data

The development of a BRA depends on the reliability of and uncertainties with the analytical data available to the risk assessor. Analytical data are limited by the precision and accuracy of the analytical method of analysis. In addition, the statistical methods used to compile and analyze the data (mean concentration, standard deviation, and detection frequencies) are subject to the uncertainty in the ability to acquire data.

Data validation serves to reduce some of the inherent uncertainty associated with the analytical data by establishing the usability of the data to the risk assessor who may or may not choose to include the data point in the estimation of risk. Data qualified as "J" (estimated) were retained for the estimation of risk at OU No. 6. Data can be qualified as estimated for many reasons including a slight exceedance of holding times, high or low surrogate recovery, or intra sample variability. Organic data qualified "B" (detected in blank) were not used in the estimation of risk because these levels were attributed to blank contamination. Data qualified with an "R" (rejected) were not used in the estimation of risk due to the unusable nature of the data. Section 4.1 presents a brief discussion of the data quality. Due to the comprehensive sampling and analytical program at OU No. 6, the loss of some data points qualified "B" or "R" did not significantly increase the uncertainty in the estimation of risk.

Overall, most of the validation qualifiers were associated with re-analyzed and/or diluted results. Data was replaced with the re-analyzed or diluted value. In other cases, data were rejected due to noncompliant internal standard areas or low matrix spike recovery. Overall, the data quality was acceptable.

6.7.2 Exposure Assessment

In performing exposure assessments, uncertainties can arise from two main sources. First, the chemical concentration to which a receptor may be exposed must be estimated for every medium of interest. Second, uncertainties can arise in the estimation of contaminant intakes resulting from contact by a receptor with a particular medium.

Estimating the contaminant concentration in a given medium to which a human receptor could potentially be exposed can be as simple as deriving the 95th percent upper confidence limit of the mean for a data set. More complex methods of deriving the contaminant concentration are necessary when exposure to COPCs in a given medium occurs subsequent to release from another medium, or when analytical data are not available to characterize the release. In this case, modeling is usually employed to estimate the potential human exposure.

The potential inhalation of fugitive dusts from affected soils was estimated in the BRA using USEPA's Rapid Assessment of Exposure to Particulate Emissions from Surface Contaminated Sites (Cowherd et al. 1985). The Cowherd model employs the use of a default PEF for wind erosion based on a one-half acre source area and 50 percent vegetative cover. Modeling results for fugitive dust emission exposure suggested that the potential risk associated with this pathway was not significant.

Groundwater samples were analyzed for total (unfiltered) and dissolved (filtered) inorganic contaminants. These samples were obtained from wells which were constructed using USEPA Region IV monitoring well design specifications. Groundwater taken from monitoring wells cannot be considered representative of potable groundwater or groundwater which is obtained from a domestic well "at the tap". The use of total inorganic analytical results overestimates the potential human health risks associated with potable use scenarios. However, for the sake of conservatism, total organic results were used to estimate the potential intake associated with groundwater use.

As stated previously, both the shallow and deep groundwater analytical results were combined and evaluated as single data set for the risk evaluation. It is important to note that the shallow groundwater is not currently used for potable purposes at the site. In addition, it is highly unlikely that this groundwater will be used similarly in the future. However, because it was determined (see Section 2.0 of this report) that the shallow and deep groundwater systems are interconnected, the data were combined and evaluated as a single set for the risk assessment. Use of this combined data set lends a certain degree of uncertainty to the risks calculated for groundwater exposure.

To estimate an intake, certain assumptions must be made about exposure events, exposure durations, and the corresponding assimilation of contaminants by the receptor. Exposure factors, have been generated by the scientific community and have undergone review by the USEPA. Regardless of the validity of these exposure factors, they have been derived from a range of values generated by studies of limited number of individuals. In all instances, values used in the risk assessment, scientific judgments, and conservative assumptions agree with those of the USEPA. Conservative assumptions designed not to underestimate daily intakes were employed throughout the BRA and should error conservatively, thus adequately protecting human health and allowing the establishment of reasonable clean-up goals.

6.7.3 Sampling Strategy

Soil represents a medium of direct contact exposure and often is the main source of contaminants released into other media. The soil sampling depth should be applicable for the exposure pathways and contaminant transport routes of concern and should be chosen purposely within that depth interval. If a depth interval is chosen purposely, a random sample procedure to select a sampling point may be established. The assessment of surface exposure at the site is certain based on collection of samples from the shallowest depth, zero to one foot. Subsurface soil samples are important, however, if soil disturbance is likely or leaching of chemicals to groundwater is of concern.

The surface soil samples at all sites were obtained directly or very near the suspected disposal areas. Therefore, these areas would be considered areas of very high concentration which would have a significant impact on exposures.

6.7.4 Toxicity Assessment

In making quantitative estimates of the toxicity of varying doses of a compound to human receptors, uncertainties arise from two sources. First, data on human exposure and the subsequent effects are usually insufficient, if they are available at all. Human exposure data usually lack adequate concentration estimations and suffer from inherent temporal variability. Therefore, animal studies are often used; and, therefore, new uncertainties arise from the process of extrapolating animal results to humans. Second, to obtain observable effects with a manageable number of experimental animals, high doses of a compound are used over a relatively short time period. In this situation, a high dose means that experimental animal exposures are much greater than human environmental exposures. Therefore, when applying the results of the animal experiment to humans, the effects at the high doses must be extrapolated to approximate effects at lower doses.

In extrapolating effects from animals to humans and high doses to low doses, scientific judgment and conservative assumptions are employed. In selecting animal studies for use in dose-response calculations, the following factors are considered:

- Studies are preferred where the animal closely mimics human pharmacokinetics
- Studies are preferred where dose intake most closely mimics the intake route and duration for humans
- Studies are preferred which demonstrate the most sensitive response to the compound in question

For compounds believed to cause threshold effects (i.e., noncarcinogens), safety factors are employed in the extrapolation of effects from animals to humans and from high to low doses.

Conservatism is also introduced through the use of experimentally-derived oral absorption efficiencies to adjust oral toxicity criteria (i.e., CSFs and RfDs), derived during studies based on administered dosages, for the estimation of dermal absorption. Equating the absorption efficiency of the bi-phasic dermal barrier to that of the mono-phasic gastrointestinal lining and then applying it to oral toxicity criteria in a dermal risk assessment scenario tends to generally overestimate the potential risk to human health by no more than an order of magnitude.

The use of conservative assumptions results in quantitative indices of toxicity that are not expected to underestimate potential toxic effects, but may overestimate these effects by an order of magnitude or more.

6.8 Conclusions of the BRA for Site 36

The BRA highlights the media of interest from a standpoint of human health at Site 36 by identifying areas with risk values greater than acceptable levels. Current and future potential receptors at the site included current military personnel, current trespassers (i.e., children and adults), future residents (i.e., children and adults), a current and future fisherman, and a current and future construction workers. The total risk from the site to these receptors was estimated by logically summing the multiple pathways likely to affect the receptor during a given activity. Exposure to surface soil, surface water and sediment was assessed for the current trespassers. Military receptors were assessed only for surface soil risks. Fish and crab tissue ingestion was only evaluated for the fisherman. Surface soil, subsurface soil, groundwater, surface water, and sediment exposures were evaluated for the future receptors.

6.8.1 Current Scenario

In the current case, the following receptors were assessed: military personnel, recreational fishermen, recreational users of the site surface water, trespassers, and a construction worker. Receptor exposure to surface soil, surface water, sediment, fish tissue, and crab tissue were evaluated. The potential risks associated with the current receptors, excluding the fisherman, were within acceptable risk levels. For the current fisherman, the total noncarcinogenic risk (9.1) and total carcinogenic risk (1.1×10^{-3}), mainly from fish and crab tissue ingestion, were greater than the acceptable risk levels of one and 1×10^{-4} for noncarcinogenic and carcinogenic effects, respectively. The levels of arsenic and mercury found in the fish tissue and the maximum levels of arsenic and lead detected in the crab tissue contributed these risks. Exposure to the maximum concentration of lead in the surface soil and crab tissue for a child receptor indicates the potential for adverse health effects.

The maximum level of arsenic was detected once in a white catfish fillet sample. The maximum level of mercury was found in a largemouth bass fillet sample. These two samples represent fish typically caught and ingested by residents of the area. Crabbing may be less prevalent than recreational fishing in the area, because access to the site surface water where crabs are more abundant is limited. These metals were also detected in the underlying sediment. However, they were not found in the surrounding surface water.

Table 6-21 is a summary of the risk-driving COPCs and the corresponding concentrations in the site media.

6.8.2 Future Scenario

In the future case, child and adult residents were assessed for potential exposure to groundwater, surface soil, subsurface soil, surface water, and sediment. A construction worker was evaluated for surface and subsurface soil exposure. There were no unacceptable risks associated with the construction worker. However, there were potential noncarcinogenic risks calculated for the child resident from groundwater (5.2) and subsurface soil (2.3) exposure. Similarly, there was a noncarcinogenic risk (2.2) calculated for the adult resident from groundwater exposure. These risk

values exceeded the acceptable risk value of one for noncarcinogenic effects. The maximum level of iron in groundwater contributed to these risks. In terms of lead effects, exposure to the maximum concentration of lead in the subsurface soil for a child receptor indicates the potential for adverse health effects.

As stated previously, groundwater at Site 36 is not used as a potable source. Future residential development of the site is unlikely. Based on this information, the future groundwater exposure scenario evaluated in this BRA is unlikely to occur.

As explained in Section 4.0 of this report, groundwater in the MCB Camp Lejeune area is naturally rich in iron and manganese. The positive detections of both iron and manganese were distributed throughout the site, indicative of natural site conditions rather than disposal activities (see Section 4.4.2 of this report). It is suggested that total metal concentrations in groundwater are due more to geologic conditions (i.e., naturally occurring concentrations and unconsolidated soils) and sample acquisition methods than to mobile metal concentrations in the surficial aquifer.

Metals are also prevalent in the site soils. As stated in Section 4.0 of this report, findings from the analytical program are consistent with visual observations of buried metallic objects and fill material recorded during the field investigation (see Appendices A, B, and C). Concentrations of metals in samples obtained from these portions of the study area coincide with areas of fill and buried material. The buried metal, in the presence of naturally-occurring acidic soils, is most probably the source of elevated metal concentrations.

There is no record of any historical use of iron at Site 36. Consequently, it is assumed that iron is a naturally-occurring inorganic in groundwater and soil, and its presence is not attributable to site operations.

Iron is an essential nutrient. The toxicity values associated with exposure to this metal are based on provisional studies, which have not been verified by USEPA. In fact, if iron were removed from the evaluation of risk from groundwater ingestion, the noncarcinogenic risk for the child would decrease from 5.1 to 1.5 and, for the adult, from 2.2 to 0.7, which is an acceptable noncarcinogenic risk value. The noncarcinogenic risk from exposure to subsurface soil for the child receptor would decrease to acceptable risk value (i.e., 2.2 to 0.9) if iron were removed from the evaluation. As a result, the potential human health risk from exposure to iron in groundwater and subsurface soil is a conservative and unrealistic estimate.

Table 6-21 presents a summary of the contaminants contributing the most to these risks and the corresponding media concentrations.

6.8.3 Lead

As stated previously, the maximum concentrations detected in surface soil (836J mg/kg), subsurface soil (2,680J mg/kg), and crab tissue (0.61 mg/kg) resulted in a potential unacceptable health risks to child receptors based on the results of the lead UBK model. Literature shows that these values are of the same magnitude and within the ranges of lead levels detected in similar media (Friberg et al, 1986). For example, based on one study, the mean concentration range of lead detected in street dust from residential and commercial areas in 77 midwest cities was 1,000 to 2,400 mg/kg (Friberg et al, 1986). Another study showed that the maximum level of lead in soil in a lead mining area in Idaho was 20,000 mg/kg. The natural levels of lead in soil can range from 2 to 200 mg/kg.

Another study found that the range of lead detected in shellfish can range from 0.17 to 0.21 mg/kg (Friberg et al, 1986). Other lead ranges include 0.34 to 0.80 mg/kg in fish (USEPA, 1994) and 0.01 to 2.5 mg/kg in food (Friberg et al, 1986). Based on comparison of site lead levels to these literature values, further action at Site 36 due solely to lead in soils and crab tissue is not warranted.

6.9 References

Cowherd et al., 1985. Cowherd, C. et al. Rapid Assessment of Exposure to Particulate Emissions from Surface Contamination. Prepared for EPA Office of Health and Environmental Assessment. EPA/600/8-85/002.

Foster, 1986. Foster, S.A. and P.C. Chrostowski. "Integrated Household Exposure Model for Use of Tap Water Contaminated with Volatile Organic Chemicals." Presented at the 79th Annual Meeting of the Air Pollution Control Association, Minneapolis, Minnesota. June 22-27, 1986.

USEPA, 1989. U.S. Environmental Protection Agency. Risk Assessment Guidance for Superfund Volume I. Human Health Evaluation Manual (Part A) Interim Final. Office of Solid Waste and Emergency Response. Washington, D.C. EPA/540/1-89-002. December 1989.

USEPA, 1989a. U.S. Environmental Protection Agency. Exposure Factors Handbook. July 1989.

USEPA, 1990. U.S. Protection Agency. National Oil and Hazardous Substances Pollution Contingency Plan. 55FR8665. Office of Emergency and Remedial Response. Washington, D.C. March 1990.

USEPA, 1991. U.S. Environmental Protection Agency. Risk Assessment Guidance for Superfund Volume I. Human Health Evaluation Manual Supplemental Guidance. "Standard Default Exposure Factors" Interim Final. Office of Solid Waste and Emergency Response. Washington, D.C. OSWER Directive 9285.6-03. March 25, 1991.

USEPA, 1992. U.S. Environmental Protection Agency. Dermal Exposure Assessment: Principles and Applications. Interim Report. Office of Health and Environmental Assessment. Washington, D.C. EPA/600/8-91/011B. January 1992.

USEPA, 1992a. U.S. Environmental Protection Agency. New Interim Region IV Guidance for Toxicity Equivalency Factor (TEF) Methodology. Region IV Water Management Division.

USEPA, 1992b. U.S. Environmental Protection Agency. Supplemental Guidance to RAGS: Calculating the Concentration Term. Office of Solid Waste and Emergency Response. Washington, D.C., Publication 9285.7-081. May 1992.

USEPA, 1992c. USEPA Region IV Supplemental Risk Guidance. February 11, 1992.

USEPA, 1993. U.S. Environmental Protection Agency. Region IV Waste Management Division Screening Values for Hazardous Waste Sites. Region IV, Atlanta Georgia. January 1993.

USEPA. 1995. U.S. Environmental Protection Agency. Health Effects Assessment Summary Tables Annual FY-1995. Office of Solid Waste and Emergency Response. Washington, D.C. EPA/540/R-95/036 PB95-921199. May 1995.

USEPA, 1995a. U.S. Environmental Protection Agency. Integrated Risk Information System (IRIS). Environmental Criteria and Assessment Office, Cincinnati, Ohio.

USEPA, 1995b. U.S. Environmental Protection Agency. Region III Risk-Based Concentration Table. Philadelphia, Pennsylvania. October, 1995.

USEPA, 1995c. U. S. Environmental Protection Agency. Phone conversation with Janine Dinan. Washington, D.C. November 17, 1995.

WAR, 1983. Water and Air Research, Inc. Initial Assessment Study of Marine Corps Base Camp Lejeune, North Carolina. Prepared for Naval Energy and Environmental Support Activity. 1983.

SECTION 6.0 TABLES

TABLE 6-1

**CONTAMINANTS OF POTENTIAL CONCERN
ORGANICS IN SURFACE SOIL
SITE 36, CAMP GEIGER AREA DUMP
REMEDIAL INVESTIGATION CTO-0303
MCB, CAMP LEJEUNE, NORTH CAROLINA**

Contaminant	Minimum	Maximum	Lognormal UCL	Location of Maximum	Frequency	Frequency Percent	Residential Soil RBC	Exceedance Frequency
Volatiles (µg/kg)								
Acetone	24.00	28.00	8.22	36-FDA-SB03-00	2/61	3%	780,000	0/2
Trichloroethene	4.00	4.00	7.38	36-FDA-SB03-00	1/61	2%	58,000	0/1
Tetrachloroethene	2.00	3.00	7.42	36-GW12-00	3/61	5%	12,000	0/3
Toluene	8.00	98.00	9.50	36-OF-SB01-00	4/61	7%	1,600,000	0/4
Styrene	39.00	39.00	7.98	36-GS-SB03-00	1/61	2%	1,600,000	0/1
Xylene (total)	7.00	7.00	7.37	36-OF-SB06B-00	1/61	2%	16,000,000	0/1
Semivolatiles (µg/kg)								
n-Nitroso-di-n-propylamine	320.00	320.00	218.14	36-DAB-SB03-00	1/57	2%	91	1/1
Naphthalene	48.00	120.00	219.48	36-OF-SB04-00	2/57	4%	310,000	0/2
2-Methylnaphthalene	54.00	82.00	219.30	36-OA-SB01A-00	2/57	4%	310,000	0/2
Acenaphthene	330.00	330.00	218.84	36-OF-SB04-00	1/57	2%	470,000	0/1
Dibenzofuran	150.00	150.00	215.31	36-OF-SB04-00	1/57	2%	31,000	0/1
Fluorene	200.00	200.00	215.80	36-OF-SB04-00	1/57	2%	310,000	0/1
Phenanthrene	59.00	2,500.00	251.83	36-OF-SB04-00	4/57	7%	230,000	0/4
Anthracene	780.00	780.00	229.58	36-OF-SB04-00	1/57	2%	2,300,000	0/1

TABLE 6-1 (Continued)

**CONTAMINANTS OF POTENTIAL CONCERN
ORGANICS IN SURFACE SOIL
SITE 36, CAMP GEIGER AREA DUMP
REMEDIAL INVESTIGATION CTO-0303
MCB, CAMP LEJEUNE, NORTH CAROLINA**

Contaminant	Minimum	Maximum	Lognormal UCL	Location of Maximum	Frequency	Frequency Percent	Residential Soil RBC	Exceedance Frequency
Semivolatiles (µg/kg) (Continued)								
Carbazole	240.00	240	216.59	36-OF-SB04-00	1/57	2%	32,000	0/1
Fluoranthene	54.00	5,500	268.60	36-OF-SB04-00	5/57	9%	310,000	0/5
Pyrene	41.00	11,000	289.09	36-OF-SB04-00	8/57	14%	230,000	0/8
Butylbenzylphthalate	51.00	290	220.42	36-OA-SB03-00	3/57	5%	1,600,000	0/3
Benzo(a)anthracene	46.00	3,900	265.94	36-OF-SB04-00	2/57	4%	880	1/2
Chrysene	51.00	4,600	266.49	36-OF-SB04-00	5/57	9%	88,000	0/5
Bis(2-ethylhexyl)phthalate	46.00	670	253.44	36-OA-SB05-00	16/57	28%	46,000	0/16
Benzo(b)fluoranthene	51.00	3,600	262.34	36-OF-SB04-00	3/57	5%	880	1/3
Benzo(k)fluoranthene	39.00	1,500	245.50	36-OF-SB04-00	2/57	4%	8,800	0/2
Benzo(a)pyrene	40.00	3,300	263.13	36-OF-SB04-00	2/57	4%	88	1/2
Indeno(1,2,3-cd)pyrene	46.00	2,700	257.22	36-OF-SB04-00	3/57	5%	880	1/3
Dibenzo(a,h)anthracene	720.00	720	228.12	36-OF-SB04-00	1/57	2%	88	1/1
Benzo(g,h,i)perylene	2,400.00	2,400	251.41	36-OF-SB04-00	1/57	2%	230,000	0/1
Pesticides/PCBs (µg/kg)								
gamma-BHC (Lindane)	4.00	4.00	1.90	36-OF-SB06D-00	1/57	2%	490	0/1
Heptachlor	1.90	1.90	1.85	36-FCA-SB12-00	1/57	2%	140	0/1
Aldrin	5.50	1,400.00	4.44	36-OF-SB03-00	3/57	5%	38	1/3
Heptachlor epoxide	2.00	67.00	3.67	36-OA-SB11-00	10/57	18%	70	0/10

TABLE 6-1 (Continued)

CONTAMINANTS OF POTENTIAL CONCERN
 ORGANICS IN SURFACE SOIL
 SITE 36, CAMP GEIGER AREA DUMP
 REMEDIAL INVESTIGATION CTO-0303
 MCB, CAMP LEJEUNE, NORTH CAROLINA

Contaminant	Minimum	Maximum	Lognormal UCL	Location of Maximum	Frequency	Frequency Percent	Residential Soil RBC	Exceedance Frequency
Pesticides/PCBs (µg/kg) (Continued)								
Endosulfan I	8.30	36	4.13	36-OASB01E-00	3/57	5%	47,000	0/3
Dieldrin	2.00	16,000	48.73	36-OF-SB03-00	21/57	37%	40	5/21
4,4'-DDE	2.20	2,600	440.33	36-OA-SB01A-00	49/57	86%	1,900	1/49
Endrin	9.90	9.90	3.85	36-OA-SB08-00	1/57	2%	2,300	0/1
4,4'-DDD	2.80	550	52.64	36-OA-SB01A-00	37/57	65%	2,700	0/37
Endosulfan sulfate	2.50	4.20	3.73	36-OF-SB06-00	2/57	4%	47,000	0/2
4,4'-DDT	1.80	12,000	240.54	36-OA-SB01A-00	48/57	84%	1,900	2/48
Endrin ketone	15.00	15	3.98	36-OF-SB03-00	1/57	2%	2,300	0/1
Endrin aldehyde	12.00	12	3.89	36-OF-SB02-00	1/57	2%	2,300	0/1
alpha-Chlordane	1.20	980	14.04	36-OA-SB05-00	15/57	26%	490	1/15
gamma-Chlordane	1.20	840	6.45	36-OA-SB05-00	10/57	18%	490	1/10
Aroclor-1248	68.00	24,000	291.42	36-OA-SB01I-00	9/57	16%	83	8/9
Aroclor-1254	92.00	530	50.60	36-OA-SB01-00	3/57	5%	160	2/3

Notes:

COPCs are indicated by the shaded areas.

TABLE 6-2

**CONTAMINANTS OF POTENTIAL CONCERN
INORGANICS IN SURFACE SOIL
SITE 36, CAMP GEIGER AREA DUMP
REMEDIAL INVESTIGATION CTO-0303
MCB, CAMP LEJEUNE, NORTH CAROLINA**

Contaminant	Minimum	Maximum	Lognormal UCL	Location of Maximum	Frequency	Frequency Percent	Site Background	Exceedance Frequency	Residential Soil RBC, mg/kg	Exceedance Frequency
Inorganics (mg/kg)										
Aluminum	1,010	17,600	5,808.71	36-FCA-SB09-00	52/52	100%	5,940.59	13/52	7,800	5/52
Antimony	3.3	31.7	3.38	36-OA-SB08-00	7/46	15%	5.34	5/7	3.1	7/7
Arsenic	0.39	10.4	2.40	36-OA-SB08-00	43/52	83%	1.3	22/43	0.43	41/43
Barium	4.5	141	31.66	36-OA-SB08-00	51/52	98%	17.36	29/51	550	0/51
Beryllium	0.18	0.18	0.10	36-FCA-SB10-00	1/52	2%	0.21	0/1	0.15	1/1
Cadmium	0.67	6.3	0.71	36-OA-SB08-00	8/52	15%	0.69	7/8	3.9	1/8
Calcium	106	103,000	45,291.21	36-OF-SB06-00	51/52	98%	1,396.79	30/51	NA	NA
Chromium	1.6	51.6	11.29	36-OA-SB08-00	52/52	100%	6.69	27/52	39	1/52
Cobalt	0.88	9	0.82	36-OA-SB08-00	10/52	19%	1.92	3/10	470	0/10
Copper	0.56	445	98.22	36-OA-SB08-00	39/52	75%	7.2	25/39	310	1/39
Iron	863	86,200	11,299.70	36-OA-SB08-00	52/52	100%	3,755.06	29/52	2,300	39/52
Lead	4.3	836	110.52	36-OA-SB08-00	48/52	92%	23.75	24/48	400	2/43
Magnesium	52	1,020	388.50	36-DAD-SB01-00	52/52	100%	205.75	31/52	NA	NA
Manganese	2.1	940	101.62	36-OA-SB08-00	52/52	100%	18.5	29/52	1,100 ¹	0/52
Mercury	0.11	2.4	0.37	36-OA-SB05-00	18/52	35%	0.09	18/18	2.3	1/18
Nickel	1	48.3	4.19	36-OA-SB08-00	26/52	50%	3.43	13/26	160	0/26

TABLE 6-2 (Continued)

CONTAMINANTS OF POTENTIAL CONCERN
 INORGANICS IN SURFACE SOIL
 SITE 36, CAMP GEIGER AREA DUMP
 REMEDIAL INVESTIGATION CTO-0303
 MCB, CAMP LEJEUNE, NORTH CAROLINA

Contaminant	Minimum	Maximum	Lognormal UCL	Location of Maximum	Frequency	Frequency Percent	Site Background	Exceedance Frequency	Residential Soil RBC, mg/kg	Exceedance Frequency
Inorganics (mg/kg) (Continued)										
Potassium	33.7	676	238.82	36-FCA-SB05-00	32/52	62%	199.61	19/32	NA	NA
Selenium	0.32	0.53	0.26	36-OF-SB06D-00	12/52	23%	0.75	0/12	39	0/12
Silver	0.61	12	0.79	36-OF-SB04-00	8/48	17%	0.88	5/8	39	0/8
Sodium	9.6	358	53.87	36-DAD-SB01-00	31/52	60%	59.3	9/31	NA	NA
Vanadium	2.9	46	16.00	36-OA-SB08-00	50/52	96%	11.63	20/50	55	0/50
Zinc	2.1	1,320	346.11	36-OA-SB08-00	50/52	96%	13.88	34/50	2,300	0/50

Notes:

COPCs indicated by the shaded areas.

¹ The residential soil RBC for manganese is based on an oral RfD of 0.14 mg/kg/day and not 0.005 mg/kg/day, as listed in the Region III RBC table (October, 1995). The latter toxicity value has been withdrawn from IRIS.

TABLE 6-3

**CONTAMINANTS OF POTENTIAL CONCERN
ORGANICS IN SUBSURFACE SOIL
SITE 36, CAMP GEIGER AREA DUMP
REMEDIAL INVESTIGATION CTO-0303
MCB, CAMP LEJEUNE, NORTH CAROLINA**

Contaminant	Minimum	Maximum	Lognormal UCL	Location of Maximum	Frequency	Frequency Percent	Residential Soil RBC $\mu\text{g}/\text{kg}$	Exceedance Frequency
Volatiles ($\mu\text{g}/\text{kg}$)								
Acetone	12.00	480.00	23.93	36-GS-SB03-02	8/62	13%	780,000	0/8
1,2-Dichloroethene (total)	4.00	4.00	6.32	36-OA-SB01-01	1/62	2%	70,000	0/1
2-Butanone	10.00	170.00	8.06	36-GS-SB03-02	3/62	5%	4,700,000	0/3
Trichloroethene	3.00	5.00	6.30	36-FDA-SB01-02	3/62	5%	58,000	0/3
Benzene	3.00	3.00	6.33	36-FDA-SB01-02	1/62	2%	22,000	0/1
Toluene	5.00	17.00	6.95	36-OF-SB06-03	5/62	8%	1,600,000	0/5
Xylene (total)	2.00	6.00	6.30	36-FDA-SB06-07	8/62	13%	16,000,000	0/8
Semivolatiles ($\mu\text{g}/\text{kg}$)								
1,4-Dichlorobenzene	97.00	97.00	208.68	36-DAB-SB02-02	1/57	2%	27,000	0/1
2-Methylphenol	510.00	510.00	215.87	36-DAB-SB01-01	1/58	2%	390,000	0/1
4-Methylphenol	43.00	43.00	213.11	36-DAB-SB01-01	1/58	2%	39,000	0/1
Isophorone	2,100.00	2,100.00	239.86	36-DAB-SB01-01	1/58	2%	670,000	0/1
Naphthalene	41.00	41.00	213.73	36-OA-SB01A-01	1/57	2%	310,000	0/1
2-Methylnaphthalene	65.00	85.00	210.22	36-FDA-SB02-04	2/57	4%	310,000	0/2
Phenanthrene	48.00	190.00	211.35	36-OA-SB07-01	3/57	5%	230,000	0/3
Di-n-butylphthalate	56.00	56.00	395.43	36-OA-SB01-01	1/58	2%	780,000	0/1
Fluoranthene	130.00	320.00	209.89	36-OA-SB07-01	3/57	5%	310,000	0/3
Pyrene	59.00	320.00	211.27	36-OA-SB07-01	5/57	9%	230,000	0/5
Butylbenzylphthalate	42.00	170.00	212.29	36-OA-SB03-03	3/57	5%	1,600,000	0/3
Benzo(a)anthracene	69.00	140.00	208.17	36-OA-SB07-01	3/57	5%	880	0/3
Chrysene	41.00	200.00	213.05	36-OA-SB07-01	5/57	9%	88,000	0/5
Bis(2-ethylhexyl)phthalate	39.00	530.00	220.99	36-GW07-01	13/58	22%	46,000	0/13

TABLE 6-3 (Continued)

CONTAMINANTS OF POTENTIAL CONCERN
 ORGANICS IN SUBSURFACE SOIL
 SITE 36, CAMP GEIGER AREA DUMP
 REMEDIAL INVESTIGATION CTO-0303
 MCB, CAMP LEJEUNE, NORTH CAROLINA

Contaminant	Minimum	Maximum	Lognormal UCL	Location of Maximum	Frequency	Frequency Percent	Residential Soil RBC $\mu\text{g}/\text{kg}$	Exceedance Frequency
Semivolatiles ($\mu\text{g}/\text{kg}$) (Continued)								
Benzo(b)fluoranthene	44.00	170.00	211.76	36-OA-SB07-01	5/57	9%	880	0/5
Benzo(k)fluoranthene	42.00	68.00	213.22	36-OA-SB07-01	3/57	5%	8,800	0/3
Benzo(a)pyrene	72.00	450.00	209.92	36-GS-SB03-02	4/57	7%	88	1/4
Indeno(1,2,3-cd)pyrene	48.00	110.00	212.40	36-OA-SB07-01	3/57	5%	880	0/3
Benzo(g,h,i)perylene	42.00	89.00	212.50	36-OA-SB07-01	2/57	4%	230,000	0/2
Pesticides/PCBs ($\mu\text{g}/\text{kg}$)								
gamma-BHC (Lindane)	4.00	4.00	1.39	36-OF-SB06D-02	1/56	2%	490	0/1
Aldrin	1.50	16.00	1.91	36-GW11-04	5/56	9%	38	0/5
Heptachlor epoxide	3.40	14.00	1.56	36-GW11-04	3/56	5%	70	0/3
Dieldrin	2.20	1,200.00	10.39	36-FDA-SB05-01	17/56	30%	40	2/17
4,4'-DDE	2.30	1,700.00	433.30	36-OA-SB01A-01	29/56	52%	1,900	0/29
Endrin	2.40	5.00	2.82	36-OF-SB06B-02	5/56	9%	2,300	0/5
Endosulfan II	2.00	2.00	2.64	36-OF-SB06B-02	1/56	2%	47,000	0/1
4,4'-DDD	2.30	1,300.00	256.17	36-FDA-SB05-01	30/56	54%	2,700	0/30
4,4'-DDT	2.80	3,100.00	60.62	36-OA-SB01A-01	28/56	50%	1,900	1/28
Endrin aldehyde	3.50	32.00	3.16	36-FDA-SB05-01	3/56	5%	2,300	0/3
alpha-Chlordane	1.60	750.00	5.36	36-GW11-04	12/56	21%	490	1/12
gamma-Chlordane	2.30	770.00	4.86	36-GW11-04	9/56	16%	490	1/9
Aroclor-1248	19.00	850.00	43.39	36-OA-SB01-01	5/56	9%	83	3/5

Notes:

COPCs indicated by the shaded areas.

TABLE 6-4

**CONTAMINANTS OF POTENTIAL CONCERN
INORGANICS IN SUBSURFACE SOIL
SITE 36, CAMP GEIGER AREA DUMP
REMEDIAL INVESTIGATION CTO-0303
MCB, CAMP LEJEUNE, NORTH CAROLINA**

Contaminant	Minimum	Maximum	Lognormal UCL	Location of Maximum	Frequency	Frequency Percent	Site Background	Exceedance Frequency	Residential Soil RBC	Exceedance Frequency
Inorganics (mg/kg)										
Aluminum	752	19,700	7,190.02	36-FDA-SB05-01	51/51	100%	7,375.3	13/51	7,800	10/51
Antimony	4.9	21.6	3.71	36-GW11-04	7/44	16%	6.4	3/7	3.1	7/7
Arsenic	0.23	25.9	6.84	36-FDA-SB01-02	41/51	80%	1.97	18/41	0.43	38/41
Barium	2	475	70.37	36-GW11-04	50/51	98%	14.2	23/50	550	0/50
Beryllium	0.17	0.18	0.10	36-FCA-SB10-02	2/51	4%	0.191	0/2	0.15	2/2
Cadmium	0.66	42.8	2.11	36-GW11-04	11/51	22%	0.712	9/11	3.9	6/11
Calcium	14.8	46,300	23,775.05	36-OF-SB06B-02	49/51	96%	391.5	26/49	NA	NA
Chromium	1.4	71.9	15.92	36-GW11-04	50/51	98%	12.6	14/50	39	2/50
Cobalt	0.48	9.4	1.74	36-OA-SB07-01	16/51	31%	1.5	10/16	470	0/16
Copper	0.46	1,320	344.57	36-OF-SB06B-02	31/51	61%	2.4	25/31	310	3/31
Iron	408	132,000	31,266.78	36-GW11-04	51/51	100%	7,252.08	18/51	2300	40/51
Lead	1.2	2,680	473.54	36-OA-SB07-01	50/51	98%	8.33	32/50	400	7/50
Magnesium	20.2	2,700	429.98	36-GW11-04	51/51	100%	260.7	18/51	NA	NA
Manganese	0.85	1,260	506.62	36-FDA-SB01-02	47/51	92%	7.9	26/47	1,100 ¹	2/47
Mercury	0.12	3.9	0.33	36-OA-SB07-01	13/51	25%	0.13	12/13	2.3	1/13
Nickel	1.1	72.1	20.24	36-DAD-SB02-01	24/51	47%	3.7	19/24	160	0/24
Potassium	47.2	1,640	258.88	36-FDA-SB06-07	32/51	63%	347.2	8/32	NA	NA
Selenium	0.43	1.2	0.22	36-OF-SB06-03	4/51	8%	0.8	1/4	39	0/4
Silver	0.55	0.89	0.34	36-GW11-04	3/48	6%	0.87	1/3	39	0/3
Sodium	5.2	501	93.66	36-FDA-SB06-07	34/51	67%	52.7	17/34	NA	NA
Vanadium	1.6	52.6	12.79	36-OF-SB06-03	49/51	96%	13.5	8/49	55	0/49
Zinc	0.85	2,580	6,813.88	36-FDA-SB05-01	41/51	80%	6.7	28/41	2,300	2/41

Notes:

COPCs indicated by shaded areas.

¹ The residential soil RBC for manganese is based on an oral RfD of 0.14 mg/kg/day and not 0.005 mg/kg/day, as listed in the Region III RBC table (October, 1995). The latter toxicity value has been withdrawn from IRIS.

TABLE 6-5

CONTAMINANTS OF POTENTIAL CONCERN
 IN GROUNDWATER
 SITE 36, CAMP GEIGER AREA DUMP
 REMEDIAL INVESTIGATION CTO-0303
 MCB, CAMP LEJEUNE, NORTH CAROLINA

Contaminant	Minimum	Maximum	Lognormal UCL	Location of Maximum	Frequency	Frequency Percent	Tap Water RBC	Exceedance Frequency	Federal MCL	Exceedance Frequency	NCWQS	Exceedance Frequency
Volatiles (µg/L)												
Methylene chloride	1.00	1.00	5.49	36-GW10-02	1/29	3%	4.1	0/1	NA	NA	5	0/1
1,2-Dichloroethene (total)	4.00	37.00	9.07	36-GW10IW-02	8/29	28%	5.5	6/8	70	0/8	NA	NA
Trichloroethene	3.00	97.00	11.51	36-GW10IW-02	10/29	34%	1.6	10/10	5	6/10	NA	NA
Tetrachloroethene	1.00	2.00	5.48	36-GW10IW-02	2/29	7%	1.1	1/2	5	0/2	0.7	2/2
1,1,2,2-Tetrachloroethane	3.00	10.00	5.53	36-GW10IW-01	6/29	21%	0.052	6/6	NA	NA	NA	NA
Semivolatiles (µg/L)												
Bis(2-ethylhexyl)phthalate	1.00	5.00	5.85	36-GW09-01	2/17	12%	4.8	1/2	6	0/1	3	1/2
Pesticide(µg/L)												
4,4'-DDD	0.06	0.06	0.05	36-GW10-01	1/18	6%	0.28	0/1	NA	NA	NA	NA
Metals (µg/L)												
Aluminum	21.90	705.00	313.86	36-GW12-01	8/22	38%	3,700	0/8	NA	NA	NA	NA
Arsenic	3.40	3.60	1.30	36-GW01-01	2/22	9%	1.1/0.045	2/2	50	0/2	50	0/2
Barium	11.50	290.00	218.52	36-GW01-01	19/22	86%	260	1/18	2,000	0/1	2,000	0/1
Cadmium	3.00	3.00	1.80	36-GW11DW-01	1/22	5%	1.8	1/1	5	0/1	5	0/1
Calcium	1,740.00	191,000.00	217,193.86	36-GW11-01	22/22	100%	NA	NA	NA	NA	NA	NA
Iron	3.30	16,900.00	109,582.80	36-GW02-01	21/22	95%	1,100	6/21	NA	NA	300	11/21
Lead	2.20	14.70	2.62	36-GW12IW-01	3/22	14%	NA	NA	15	0/3	15	0/3
Magnesium	274.00	42,800.00	32,219.51	36-GW11-01	22/22	100%	NA	NA	NA	NA	NA	NA
Manganese	2.20	3,180.00	1,200.03	36-GW09-01	21/22	95%	510 ¹	2/21	NA	NA	50	12/21
Mercury	1.40	1.40	0.17	36-TW02-01	1/22	5%	1.1	1/1	2	0/1	1.1	1/1
Nickel	7.40	65.20	6.81	36-TW02-01	2/22	9%	73	0/2	100	0/2	100	0/2
Potassium	620.00	37,900.00	30,374.70	36-GW11-01	22/22	100%	NA	NA	NA	NA	NA	NA
Selenium	1.60	3.30	1.07	36-GW11-01	2/22	9%	18	0/2	50	0/2	50	0/2
Sodium	6,710.00	308,000.00	62,893.15	36-TW02-01	22/22	100%	NA	NA	NA	NA	NA	NA

TABLE 6-5 (Continued)

CONTAMINANTS OF POTENTIAL CONCERN
 IN GROUNDWATER
 SITE 36, CAMP GEIGER AREA DUMP
 REMEDIAL INVESTIGATION CTO-0303
 MCB, CAMP LEJEUNE, NORTH CAROLINA

Contaminant	Minimum	Maximum	Lognormal UCL	Location of Maximum	Frequency	Frequency Percent	Tap Water RBC	Exceedance Frequency	Federal MCL	Exceedance Frequency	NCWQS	Exceedance Frequency
Metals (µg/L) (Continued)												
Vanadium	2.60	6.70	1.59	36-GW10DW-01	2/22	9%	26	0/2	NA	NA	NA	NA
Zinc	3.70	224.00	33.93	36-GW09-01	4/22	18%	1,100	0/4	NA	NA	2,100	0/4

Notes:

COPCs are indicated by the shaded areas.

¹ The tap water RBC for manganese is based on an oral RfD of 0.14 mg/kg/day and not 0.005 mg/kg/day, as listed in the Region III RBC table (October, 1995). The latter toxicity value has been withdrawn from IRIS.

TABLE 6-6

CONTAMINANTS OF POTENTIAL CONCERN IN SURFACE WATER
 SITE 36, CAMP GEIGER AREA DUMP
 REMEDIAL INVESTIGATION CTO-0303
 MCB, CAMP LEJEUNE, NORTH CAROLINA

Contaminants	Minimum	Maximum	Lognormal UCL	Location of Maximum	Frequency	Frequency Percent	Base-Wide Average	Federal Water and Organisms	Federal Organisms only	State Freshwater	Region IV Water and Organisms	Region IV Organisms Only
Volatiles (µg/L)												
1,2-Dichloroethene (total)	7.00	7.00	5.87	36-SW02	1/7	14%	NA	--	--	--	--	--
Inorganics (µg/L)												
Aluminum	1.00	2.40	2.22	36-SW03	4/7	57%	333.17	--	--	--	--	--
Antimony	1.90	3.90	6.99	36-SW05	5/7	71%	ND	0.018	0.14	--	0.018	0.14
Barium	12.10	39.80	32.40	36-SW03	3/7	43%	25.67	--	--	--	--	--
Calcium	19,500.00	48,800.00	51,803.88	36-SW07	6/7	86%	17,566.67	--	--	--	--	--
Copper	56.50	56.50	73.12	36-SW01	1/7	14%	ND	--	--	--	1,300.00	--
Iron	967.00	4,840.00	3,988.09	36-SW03	7/7	100%	575.67	--	--	--	--	--
Magnesium	1,550.00	17,900.00	236,731.48	36-SW05	6/7	86%	1,744.67	--	--	--	--	--
Manganese	24.50	126.00	270.13	36-SW03	6/7	86%	ND	--	--	--	--	--
Molybdenum	35.00	65.00	79.22	36-SW05	5/7	71%	ND	--	--	--	--	--
Nickel	16.40	31.40	59.75	36-SW02	4/7	57%	ND	610.00	4,600.00	--	610.00	4,600.00
Potassium	5,310.00	18,800.00	13,041.80	36-SW01	7/7	100%	ND	--	--	--	--	--
Sodium	82,000.00	330,000.00	244,180.80	36-SW01	7/7	100%	9,830	--	--	--	--	--
Thallium	1.10	1.10	0.76	36-SW04	1/7	14%	ND	1.70	6.30	--	1.70	6.30
Vanadium	4.50	387.00	8,350.99	36-SW01	7/7	100%	ND	--	--	--	--	--

Notes:

COPCs indicated by the shaded areas.

TABLE 6-7

**CONTAMINANTS OF POTENTIAL CONCERN IN SEDIMENT
SITE 36, CAMP GEIGER AREA DUMP
REMEDIAL INVESTIGATION CTO-0303
MCB, CAMP LEJEUNE, NORTH CAROLINA**

Contaminant	Minimum	Maximum	Log UCL	Location of Maximum	Frequency	Percent	Base-Wide Average	Region IV Criteria ER-L	Region IV Criteria ER-M	ER-L (Long et. al., 1995)	ER-M (Long et. al., 1995)
Volatiles (µg/kg)											
Tetrachloroethene	4	4	14.89	36-SD04-612	1/13	8%	ND				
Semivolatiles (µg/kg)											
Diethylphthalate	330	2,135	1,110.39	36-SD05-06	3/13	23%	ND	--	--	--	--
Anthracene	46	46	1,001.60	36-SD04-612	1/13	8%	ND				
Di-n-butylphthalate	218	218	760.23	36-SD06-612	1/13	8%	ND	--	--	--	--
Pyrene	316	316	764.00	36-SD02-612	1/13	8%	ND	350	2200	665.00	2,600.00
Bis(2-ethylhexyl)phthalate	242	328	761.83	36-SD02-612	2/13	15%	ND	--	--	--	--
Pesticides (µg/kg)											
Aldrin	0.93	0.93	45.46	36-SD01-06	1/13	8%	1.05	--	--	--	--
Dieldrin	0.80	52	150.80	36-SD06-06	3/13	23%	1.96	0.02	8	--	--
4,4'-DDE	32	1,200	2,435.88	36-SD05-612	9/13	69%	2.42	2	15	2.20	27.00
Endrin	6.60	6.60	35.83	36-SD02-612	1/13	8%	ND	0.02	45	--	--
4,4'-DDD	14	1,140	4,233.50	36-SD05-612	12/13	92%	1.57	2	20	--	--
Endosulfan sulfate	3	3	89.34	36-SD02-612	1/13	8%	ND	--	--	--	--
4,4'-DDT	3	46	33.37	36-SD05-612	11/13	85%	2.20	1	7	1.58	46.10
Endrin ketone	11	11	75.50	36-SD03-06	1/13	8%	ND	0.02	45	--	--
Endrin aldehyde	3.50	7.60	87.36	36-SD05-06	2/13	15%	2.01	0.02	45	--	--
alpha-Chlordane	6.50	13.00	39.70	36-SD07-06	2/13	15%	1.20	0.5	6	--	--
Inorganics (mg/kg)											
Aluminum	1,560	31,500	19,839.17	36-SD07-06	15/15	100%	1,165.57	--	--	--	--
Arsenic	0.67	3.30	2.41	36-SD08-01	13/13	100%	0.37	33	85	8.20	70.00
Barium	2.40	79.10	68.51	36-SD01-06	15/15	100%	6.46	--	--	--	--
Beryllium	0.16	1.30	0.81	36-SD01-06	4/15	27%	0.09	--	--	--	--
Cadmium	1.40	8.70	3.75	36-SD02-612	2/15	14%	0.04	5	9	1.20	9.60

TABLE 6-7 (Continued)

CONTAMINANTS OF POTENTIAL CONCERN IN SEDIMENT
 SITE 36, CAMP GEIGER AREA DUMP)
 REMEDIAL INVESTIGATION CTO-0303
 MCB, CAMP LEJEUNE, NORTH CAROLINA

Contaminant	Minimum	Maximum	Log UCL	Location of Maximum	Frequency	Percent	Base-Wide Average	Region IV Criteria ER-L	Region IV Criteria ER-M	ER-L (Long et. al., 1995)	ER-M (Long et. al., 1995)
Inorganics (mg/kg) (Continued)											
Calcium	301	17,500	31,268.66	36-SD07-06	14/15	93%	1,967.14	--	--	--	--
Chromium	2.40	28.60	23.06	36-SD07-06	14/15	93%	1.86	80	145	81.00	370.00
Cobalt	1.10	6.30	4.20	36-SD01-06	3/15	20%	ND	--	--	--	--
Copper	3.20	45.10	19.88	36-SD03-06	15/15	100%	0.75	70	390	34.00	270.00
Iron	1,090	15,900	11,661.09	36-SD05-612	15/15	100%	433.71	--	--	--	--
Lead	7.10	15,100	3,422.99	36-SD06-06	14/14	100%	0.79	35	110	46.70	218.00
Magnesium	151	3,830	2,601.52	36-SD07-06	14/15	93%	45.25	--	--	--	--
Manganese	4.70	62.80	45.17	36-SD05-612	15/15	100%	3.63	--	--	--	--
Mercury	0.18	0.66	413.49	36-SD04-612	3/4	75%	0.14				
Nickel	2.10	77.10	25.81	36-SD03-06	11/15	85%	ND	30	50	20.90	51.60
Potassium	193	2,610	1,140.32	36-SD07-06	5/15	33%	ND	--	--	--	--
Selenium	0.71	0.71	0.94	36-SD08-01	1/15	7%	0.19	-	-	-	-
Sodium	487	4,980	3,079.05	36-SD05-06	13/15	87%	ND	--	--	--	--
Thallium	0.19	0.96	0.65	36-SD07-06	8/15	62%	0.10	--	--	--	--
Vanadium	3.20	314	83.12	36-SD03-06	15/15	100%	1.52	--	--	--	--
Zinc	25.30	140	355.51	36-SD02-612	5/5	100%	5.11	120	270	150.00	410.00

Notes:

COPCs are indicated by the shaded areas.

TABLE 6-8

CONTAMINANTS OF POTENTIAL CONCERN
 IN FISH AND CRAB TISSUE
 SITE 36, CAMP GEIGER AREA DUMP
 REMEDIAL INVESTIGATION CTO-0303
 MCB, CAMP LEJEUNE, NORTH CAROLINA

Contaminant	Minimum	Maximum	Lognormal UCL	Location of Maximum	Frequency	Fish Tissue RBC
Fish Tissue						
Volatiles (µg/kg)						
Methylene Chloride	26.00	50.00	76.42	36-FS03-WC-F01	3/15	420.00
Acetone	58.00	2,788.00	1,806.69	36-FS03-LMB-F01	8/15	14,000.00
Carbon Disulfide	196.00	1,328.00	963.82	35-FS03-SM-F01	15/15	14,000.00
2-Butanone	63.00	5,108.00	891.86	36-FS03-LMB-F01	2/15	81,000.00
Toluene	24.00	24.00	72.63	35-FS03-SM-F01	1/15	27,000.00
Pesticides (µg/kg)						
beta-BHC	4.20	11.00	8.30	36-FS03-WM-F01	4/19	2.00
gamma-BHC (Lindane)	2.50	5.50	8.33	36-FS01-SM-F01	4/19	2.00
Heptachlor	2.80	4.30	8.27	35-FS03-BG-F01	2/19	1.00
Aldrin	5.70	6.60	7.81	36-FS03-SM-F01	2/19	0.19
Heptachlor epoxide	3.90	3.90	8.05	35-FS03-LG-F01	1/19	0.35
Dieldrin	4.30	48.00	24.90	36-FS03-SM-F01	15/19	0.20
4,4'-DDE	39.00	572.00	335.84	35-FS03-LG-F02	19/19	9.00
Endrin	2.50	52.00	15.11	35-FS03-LG-F02	9/19	41.00
Endosulfan II	3.60	9.60	16.72	35-FS03-LG-F02	4/19	810.00
4,4'-DDD	22.00	256.00	121.32	36-FS03-SM-F01	19/19	13.00
4,4'-DDT	2.50	15.00	15.62	35-FS03-WM-F01	10/19	9.00
Endrin ketone	3.60	3.80	17.90	35-FS03-WM-F01	2/19	41.00
Endrin aldehyde	2.80	13.00	18.14	36-FS03-SM-F01	3/19	41.00
alpha-Chlordane	3.50	46.00	23.57	36-FS03-SM-F01	15/19	2.00

TABLE 6-8 (Continued)

CONTAMINANTS OF POTENTIAL CONCERN
 IN FISH AND CRAB TISSUE
 SITE 36, CAMP GEIGER AREA DUMP
 REMEDIAL INVESTIGATION CTO-0303
 MCB, CAMP LEJEUNE, NORTH CAROLINA

Contaminant	Minimum	Maximum	Lognormal UCL	Location of Maximum	Frequency	Fish Tissue RBC
Fish Tissue (Cont.)						
Inorganics (mg/kg) (Continued)						
Aluminum	20.00	27.30	17.89	35-FS03-SM-F01	5/19	140.00
Arsenic	1.80	1.80	1.03	36-FS02-WC-F01	1/19	0.0021/0.041
Barium	0.41	2.20	0.93	36-FS02-SM-F01	16/19	9.50
Cadmium	0.33	0.50	0.17	35-FS03-LG-F01	3/19	0.07
Calcium	676.00	13,300.00	7,276.11	35-FS03-WM-F01	16/19	NA
Chromium	3.00	4.00	2.00	36-FS02-LMB-F01	2/19	0.68
Copper	2.30	5.60	3.30	35-FS03-SM-F01	10/19	5.40
Iron	28.00	53.60	47.26	36-FS03-WC-F02	14/19	41.00
Magnesium	833.00	1,470.00	1,276.01	36-FS03-LMB-F01	19/19	NA
Manganese	0.86	3.10	2.13	35-FS02-MC-F01	17/19	1.90
Mercury	0.29	1.30	1.00	36-FS03-LMB-F01	8/13	0.04
Potassium	9,180.00	20,200.00	16,107.54	36-FS03-LMB-F01	19/19	NA
Selenium	0.60	5.80	1.08	36-FS03-LMB-F01	3/19	0.68
Silver	1.00	3.30	1.42	36-FS03-WC-F01	5/15	0.68
Sodium	1,970.00	21,900.00	4,233.29	35-FS03-SM-F01	10/19	NA
Vanadium	1.70	1.70	1.25	36-FS03-WM-F01	1/19	0.95
Zinc	18.20	58.30	42.04	36-FS01-WC-F01	11/11	41.00

TABLE 6-8 (Continued)

**CONTAMINANTS OF POTENTIAL CONCERN
IN FISH AND CRAB TISSUE
SITE 36, CAMP GEIGER AREA DUMP
REMEDIAL INVESTIGATION CTO-0303
MCB, CAMP LEJEUNE, NORTH CAROLINA**

Contaminant	Minimum	Maximum	Lognormal UCL	Location of Maximum	Frequency	Fish Tissue RBC
Crab Tissue						
Volatiles (µg/kg) (Continued)						
Acetone	54,320.00	372,323.00	1.88E+09	36-FS03-BC02	3/3	140,000.00
Methylene Chloride	6,549.00	16,317.00	166,224.56	36-FS03-BC02	3/3	420.00
Pesticides (µg/kg)						
beta-BHC	6.80	8.90	11.21	36-FS02-BC01	3/3	1.80
gamma-BHC (Lindane)	2.10	3.60	14.20	36-FS02-BC01	2/3	2.40
Heptachlor	2.60	2.60	8.96	36-FS02-BC01	1/3	0.70
Aldrin	2.30	2.30	15.15	36-FS03-BC01	1/3	0.19
Dieldrin	6.00	9.40	16.49	36-FS02-BC01	3/3	0.20
4,4'-DDE	42.00	101.00	576.96	36-FS02-BC01	3/3	9.30
4,4'-DDD	19.00	49.00	311.96	36-FS02-BC01	3/3	13.00
4,4'-DDT	2.50	2.50	600.41	36-FS02-BC01	1/3	9.30
alpha-Chlordane	3.60	3.70	5.03	36-FS02-BC01	2/3	2.40
Inorganics (mg/kg)						
Aluminum	19.30	19.30	2,521.43	36-FS02-BC01	1/3	140.00
Arsenic	1.40	1.40	43.43	36-FS03-BC01	1/3	0.041/0.0021
Cadmium	0.16	0.80	5.48e+10	36-FS02-BC01	2/3	0.07
Calcium	1,740.00	2,170.00	2,541.98	36-FS03-BC01	3/3	NA
Cobalt	6.90	6.90	80.74	36-FS02-BC01	1/3	8.10
Copper	22.30	27.50	32.88	36-FS03-BC01	3/3	5.40
Iron	20.40	40.20	145.29	36-FS03-BC01	3/3	41.00
Lead	0.51	0.61	0.68	36-FS02-BC01	3/3	NA
Magnesium	1,500.00	1,550.00	1,573.63	36-FS02-BC01	3/3	NA
Manganese	1.70	1.70	9.93	36-FS03-BC02	1/3	1.9 ¹

TABLE 6-8 (Continued)

CONTAMINANTS OF POTENTIAL CONCERN
 IN FISH AND CRAB TISSUE
 SITE 36, CAMP GEIGER AREA DUMP
 REMEDIAL INVESTIGATION CTO-0303
 MCB, CAMP LEJEUNE, NORTH CAROLINA

Contaminant	Minimum	Maximum	Lognormal UCL	Location of Maximum	Frequency	Fish Tissue RBC
Crab Tissue (cont.)						
Inorganics (mg/kg) (Continued)						
Acetone	54,320.00	372,323.00	1.88E+09	36-FS02-BC01	3/3	NA
Potassium	13,000.00	14,400.00	15,082.49	36-FS03-BC02	3/3	NA
Selenium	0.72	0.80	4.94	36-FS02-BC01	2/3	NA
Sodium	14,200.00	15,300.00	15,933.41	36-FS02-BC01	3/3	NA
Zinc	93.80	130.00	161.89	36-FS03-BC01	3/3	NA

Notes:

COPCs indicated by the shaded areas.

¹ The residential soil RBC for manganese is based on an oral RfD of 0.14 mg/kg/day and not 0.005 mg/kg/day, as listed in the Region III RBC table (October, 1995). The latter toxicity value has been withdrawn from IRIS.

TABLE 6-9

SUMMARY OF EXPOSURE DOSE INPUT PARAMETERS
 SITE 36, CAMP GEIGER AREA DUMP
 REMEDIAL INVESTIGATION CTO-0303
 MCB, CAMP LEJEUNE, NORTH CAROLINA

Input Parameter	Units	Receptor						
		Trespasser Child	Trespasser Adult	Military Personnel	Construction Worker	Residential Child	Residential Adult	Fisherman
Soil (mg/kg)								
Ingestion Rate, IR	mg/d	200	50	100	480	200	100	NA
Fraction Ingested, FI	unitless	1	1	1	1	1	1	NA
Exposure Frequency, EF	d/y	130	43	250	90	350	350	NA
Exposure Duration, ED	y	6	30	4	1	6	30	NA
Surface Area, SA	cm ²	2,000	5,000	4,300	4,300	2,300	5,800	NA
Adherence Factor, AF	mg/cm ²	1	1	1	1	1	1	NA
Averaging Time, Noncarc., ATnc	d	2,190	10,950	1,460	365	2,190	10,950	NA
Averaging Time, Carc., ATcarc	d	25,550	25,550	25,550	25,550	25,550	25,550	NA
Body Weight, BW	kg	15	70	70	70	15	70	NA
Conversion Factor, CF	kg/mg	1x10 ⁻⁶	1x10 ⁻⁶	1x10 ⁻⁶	1x10 ⁻⁶	1x10 ⁻⁶	1x10 ⁻⁶	NA
Absorbance Factor, ABS	unitless	Organics = 0.01; Inorganics = 0.001						
Groundwater (mg/L)								
Ingestion Rate, IR	L/d	NA	NA	NA	NA	1	2	NA
Exposure Frequency, EF	d/y	NA	NA	NA	NA	350	350	NA
Exposure Duration, ED	y	NA	NA	NA	NA	6	30	NA
Exposure Time, ET	h/d	NA	NA	NA	NA	0.25	0.25	NA
Surface Area, SA	cm ²	NA	NA	NA	NA	10,000	23,000	NA
Averaging Time, Noncarc., ATnc	d	NA	NA	NA	NA	2,190	10,950	NA
Averaging Time, Carc., ATcarc	d	NA	NA	NA	NA	25,550	25,550	NA
Conversion Factor, CF	L/cm ³	NA	NA	NA	NA	0.001	0.001	NA
Body Weight, BW	kg	NA	NA	NA	NA	15	70	NA

TABLE 6-9 (Continued)

**SUMMARY OF EXPOSURE DOSE INPUT PARAMETERS
SITE 36, CAMP GEIGER AREA DUMP
REMEDIAL INVESTIGATION CTO-0303
MCB, CAMP LEJEUNE, NORTH CAROLINA**

Input Parameter	Units	Receptor						
		Trespasser Child	Trespasser Adult	Military Personnel	Construction Worker	Residential Child	Residential Adult	Fisherman
Sediment (mg/kg)								
Ingestion Rate, IR	mg/d	200	100	NA	NA	200	100	100
Fraction Ingested, FI	unitless	1	1	NA	NA	1	1	1
Exposure Frequency, EF	d/y	45	45	NA	NA	45	45	48
Exposure Duration, ED	y	6	30	NA	NA	6	30	30
Surface Area, SA	cm ²	2,000	5,000	NA	NA	2,300	5,800	5,800
Adherence Factor, AF	mg/cm ²	1	1	NA	NA	1	1	1
Averaging Time, Noncarc., ATnc	d	2,190	10,950	NA	NA	2,190	10,950	10,950
Averaging Time, Carc., ATcarc	d	25,550	25,550	NA	NA	25,550	25,550	25,550
Body Weight, BW	kg	15	70	NA	NA	15	70	70
Conversion Factor, CF	kg/mg	1x10 ⁻⁶	1x10 ⁻⁶	NA	NA	1x10 ⁻⁶	1x10 ⁻⁶	1x10 ⁻⁶
Absorbance Factor, ABS	unitless	Organics = 0.01; Inorganics = 0.001						
Surface Water (mg/L)								
Ingestion Rate, IR	L/d	0.005	0.005	NA	NA	0.005	0.005	0.005
Exposure Time, ET	h/d	2.6	2.6	NA	NA	2.6	2.6	2.6
Exposure Frequency, EF	d/y	45	45	NA	NA	45	45	48
Exposure Duration, ED	y	6	30	NA	NA	6	30	30
Surface Area, SA	cm ²	2,000	5,000	NA	NA	2,300	5,800	5,800
Averaging Time, Noncarc., ATnc	d	2,190	10,950	NA	NA	2,190	10,950	10,950
Averaging Time, Carc., ATcarc	d	25,550	25,550	NA	NA	25,550	25,550	25,550
Conversion Factor, CF	L/cm ³	0.001	0.001	NA	NA	0.001	0.001	0.001
Body Weight, BW	kg	15	70	NA	NA	15	70	70

TABLE 6-9 (Continued)

SUMMARY OF EXPOSURE DOSE INPUT PARAMETERS
 SITE 36, CAMP GEIGER AREA DUMP
 REMEDIAL INVESTIGATION CTO-0303
 MCB, CAMP LEJEUNE, NORTH CAROLINA

Input Parameter	Units	Receptor						
		Trespasser Child	Trespasser Adult	Military Personnel	Construction Worker	Residential Child	Residential Adult	Fisherman
Fish/Crab (mg/kg) (Continued)								
Averaging Time, Carc, ATcarc	d	NA	NA	NA	NA	NA	NA	25,550
Body Weight, BW	kg	NA	NA	NA	NA	NA	NA	70

References:

USEPA Risk Assessment For Superfund Volume I. Human Health Manual (Part A) Interim Final, December, 1989.

USEPA Exposure Factors Handbook, July, 1989.

USEPA Risk Assessment For Superfund Volume I. Human Health Evaluation Manual Supplemental Guidance. "Standard Default Exposure Factors" Interim Final, March 25, 1991.

USEPA Dermal Exposure Assessment: Principles and Applications. Interim Report, January, 1992.

USEPA Region IV Guidance for Soil Absorbance. (USEPA, 1992)

Notes:

The exposure frequency for the trespasser receptors is based on the typical exposure pattern (i.e., more time spent outdoors in the warmer months vs. the cooler months) for people who actively garden or play outdoors. It is an upper-bound estimate (USEPA, 1992).

The skin surface area for the trespasser receptors is based on approximately 25 percent of the total surface body area for a child and adult receptor. These values are upper-bound estimates.

TABLE 6-10

SUMMARY OF EXPOSURE PATHWAYS
 SITE 36, CAMP GEIGER AREA DUMP
 REMEDIAL INVESTIGATION, CTO-0303
 MCB, CAMP LEJEUNE, NORTH CAROLINA

Receptor	Exposure Pathway
Current Military Personnel	Surface soil ingestion, dermal contact and fugitive dust inhalation
Current Adult and Child Trespassers	Surface soil ingestion, dermal contact and fugitive dust inhalation Surface water ingestion and dermal contact (Brinson Creek and unnamed tributary) Sediment ingestion and dermal contact (Brinson Creek and unnamed tributary)
Current/Future Fisherman	Surface water ingestion and dermal contact (Brinson Creek and unnamed tributary) Sediment ingestion and dermal contact (Brinson Creek and unnamed tributary) Fish Ingestion Crab Ingestion
Current/Future Construction Worker	Surface soil ingestion, dermal contact, and fugitive dust inhalation Subsurface soil ingestion, dermal contact, and fugitive dust inhalation
Future Residential Adult and Child	Surface and subsurface soil ingestion, dermal contact and fugitive dust inhalation Groundwater ingestion, dermal contact and inhalation Surface water ingestion and dermal contact (Brinson Creek and unnamed tributary) Sediment ingestion and dermal contact (Brinson Creek and unnamed tributary)

TABLE 6-11

**SUMMARY OF HEALTH-BASED CRITERIA
SITE 36, CAMP GEIGER AREA DUMP
REMEDIAL INVESTIGATION CTO-0303
MCB, CAMP LEJEUNE, NORTH CAROLINA**

Contaminant	Oral RfD mg/kg/d	Inhalation RfD mg/kg/d	Oral CSF (mg/kg/d) ⁻¹	Inhalation CSF (mg/kg/d) ⁻¹	Weight-of-Evidence ⁽¹⁾
Volatiles					
1,2-Dichloroethene (total)	9.0E-03 (h)	--	--	--	D
Trichloroethene	6.0E-03 (e)	--	1.1E-02 (w)	6.0E-03 (e)	B2
Tetrachloroethene	1.0E-02 (i)	--	5.2E-02 (e)	2.0E-03 (e)	--
1,1,2,2-Tetrachloroethane	--	--	2.0E-01 (i)	2.0E-01 (i)	--
Semivolatiles					
n-Nitroso-di-n-propylamine	--	--	7.0E+00 (i)	--	--
Benzo(a)anthracene	--	--	7.3E-01 (e)	6.1E-01 (e)	B2
Benzo(b)fluoranthene	--	--	7.3E-01 (e)	6.1E-01 (e)	B2
Dibenz(a,h)anthracene	--	--	7.3E+00 (e)	6.1E+00 (e)	B2
Diethylphthalate	8.0E-01(i)	--	--	--	D
Di-n-butylphthalate	1.0E-01 (i)	--	--	--	D
Pyrene	3.0E-02 (i)	--	--	--	D
Benzo(a)pyrene	--	--	7.3E+00 (i)	6.1E+00 (w)	B2
Bis(2-ethylhexyl)phthalate	2.0E-02 (i)	--	1.4E-02 (i)	--	B2
Pesticides/PCBs					
Dieldrin	5.0E-05 (i)	--	1.6E+01 (i)	1.6E+01 (i)	B2
4,4'-DDE	--	--	3.4E-01 (i)	--	B2
Endrin	3.0E-04 (i)	--	--	--	D
4,4'-DDD	--	--	2.4E-01(i)	--	B2
Endosulfan sulfate ⁽²⁾	6.0E-03 (i)	--	--	--	--
4,4'-DDT	5.0E-04 (i)	--	3.4E-01(i)	3.4E-01 (i)	B2
Endrin ketone ⁽³⁾	3.0E-04 (i)	--	--	--	D
Endrin aldehyde ⁽³⁾	3.0E-04 (i)	--	--	--	D
alpha-Chlordane ⁽⁴⁾	6.0E-05 (i)	--	1.3E+00 (i)	1.3E+00 (i)	B2
gamma-Chlordane ⁽⁴⁾	6.0E-05 (i)	--	1.3E+00 (i)	1.3E+00 (i)	B2
beta-BHC	--	--	1.8E+00 (i)	1.8E+00 (i)	--
gamma-BHC (Lindane)	3.0E-04 (i)	--	1.3E+00 (h)	--	C
Heptachlor	5.0E-04 (i)	--	4.5E+00 (i)	4.6E+00 (i)	B2
Aldrin	3.0E-05 (i)	--	1.7E+01 (i)	1.7E+01 (i)	B2
Heptachlor Epoxide	1.3E-05 (i)	--	9.1E+00 (i)	9.1E+00 (i)	B2
Aroclor-1248 ⁽⁵⁾	--	--	7.7E+00 (i)	--	B2
Aroclor-1254 ⁽⁵⁾	2.0E-05 (i)	--	7.7E+00 (i)	--	B2

TABLE 6-11 (Continued)

SUMMARY OF HEALTH-BASED CRITERIA
 SITE 36, CAMP GEIGER AREA DUMP
 REMEDIAL INVESTIGATION CTO-0303
 MCB, CAMP LEJEUNE, NORTH CAROLINA

Contaminant	Oral RfD mg/kg/d	Inhalation RfD mg/kg/d	Oral CSF (mg/kg/d) ⁻¹	Inhalation CSF (mg/kg/d) ⁻¹	Weight-of-Evidence ⁽¹⁾
Metals					
Aluminum	1.0E+00 (e)	--	--	--	--
Antimony	4.0E-04 (i)	--	--	--	D
Arsenic	3.0E-04 (i)	--	1.5E+00 (i)	1.5E+01 (i)	A
Barium	7.0E-02 (i)	1.4E-04 (a)	--	--	D
Beryllium	5.0E-03 (i)	--	4.3E+00 (i)	8.4E+00 (i)	B2
Cadmium (soil) ⁽⁶⁾	1.0E-03 (i)	--	--	--	D
Cadmium (water)	5.0E-04 (i)	5.71E-04 (e)	--	6.3E+00 (i)	B1
Chromium (VI)	5.0E-03 (i)	--	--	4.2E+01 i	D
Cobalt	6.0E-02 (e)	--	--	--	--
Copper	4.0E-02 (h)	--	--	--	D
Iron	3.0E-01 (e)	--	--	--	--
Lead	--	--	--	--	B2
Mercury (inorganic)	3.0E-04 (h)	8.6E-05 (h)	--	--	D
Manganese	1.4E-01	1.4E-05 (i)	--	--	D
Molybdenum	5.0E-03 (i)	--	--	--	D
Nickel	2.0E-02 (i)	--	--	--	D
Selenium	5.0E-03 (i)	--	--	--	D
Thallium ⁽⁷⁾	8.0E-05 (i)	--	--	--	--
Vanadium	7.0E-03 (h)	--	--	--	D
Zinc	3.0E-01 (i)	--	--	--	D

Notes:

(1) Drinking Water Regulations and Health Advisories by Office of Water, USEPA, May, 1995.

(2) Toxicity factor for endosulfan.

(3) Toxicity factor for endrin.

(4) Toxicity factor for chlordane.

(5) Toxicity factor for PCBs.

(6) Toxicity factor recommended by Region IV.

(7) Toxicity factor for thallium carbonate.

i = Integrated Risk Information System (IRIS, 1995)

e = Environmental Criteria and Assessment Office (ECAO) (as cited from 1st quarter 1995 USEPA, Region III RBC ables)

h = Health Effects Assessment Summary Tables (HEAST, 1995)

a = HEAST Alternative Method, 1994

w = Withdrawn from IRIS or HEAST

-- = Information not published and/or applicable

TABLE 6-12

**SUMMARY OF DERMALLY ADJUSTED
HEALTH-BASED CRITERIA
SITE 36, CAMP GEIGER AREA DUMP
REMEDIAL INVESTIGATION CTO-0303
MCB, CAMP LEJEUNE, NORTH CAROLINA**

Contaminant	Percent Absorbed ⁽¹⁾	Oral RfD mg/kg/d	Dermally-Adjusted Oral RfD, mg/kg/d	Oral CSF (mg/kg/d) ⁻¹	Dermally-Adjusted Oral CSF, (mg/kg/d) ⁻¹
Volatiles					
1,2-Dichloroethene (total)	80%	9.0E-03	7.2E-03	--	--
Trichloroethene	80%	6.0E-03	4.8E-03	1.1E-02	1.4E-02
Tetrachloroethene	80%	1.0E-02	8.0E-03	5.2E-02	6.5E-02
1,1,2,2-Tetrachloroethane	80%	--	--	2.0E-01	2.5E-01
Semivolatiles					
n-Nitroso-di-n-propylamine	50%	--	--	7.0E+00	1.4E+01
Benzo(a)anthracene	50%	--	--	7.3E-01	1.5E+00
Benzo(b)fluoranthene	50%	--	--	7.3E-01	1.5E+00
Dibenzo(a,h)anthracene	50%	--	--	7.3E+00	1.5E+01
Diethylphthalate	50%	8.0E-01	4.0E-01	--	--
Di-n-butylphthalate	50%	1.0E-01	5.0E-02	--	--
Pyrene	50%	3.0E-02	1.5E-02	--	--
Benzo(a)pyrene	50%	--	--	7.3E+00	1.5E+01
Bis(2-ethylhexyl)phthalate	50%	2.0E-02	1.0E-02	1.4E-02	2.8E-02
Pesticides/PCBs					
Dieldrin	50%	5.0E-05	2.5E-05	1.6E+01	3.2E+01
4,4'-DDE	50%	--	--	3.4E-01	6.8E-01
Endrin	50%	3.0E-04	1.5E-04	--	--
4,4'-DDD	50%	--	--	2.4E-01	4.8E-01
Endosulfan sulfate	50%	6.0E-03	3.0E-03	--	--
4,4'-DDT	50%	5.0E-04	2.5E-04	3.4E-01	6.8E-01
Endrin ketone	50%	3.0E-04	1.5E-04	--	--
Endrin aldehyde	50%	3.0E-04	1.5E-04	--	--
alpha-Chlordane	50%	6.0E-05	3.0E-05	1.3E+00	2.6E+00
gamma-Chlordane	50%	6.0E-05	3.0E-05	1.3E+00	2.6E+00
beta-BHC	50%	--	--	1.8E+00	3.6E+00
gamma-BHC (Lindane)	50%	3.0E-04	1.5E-04	1.3E+00	2.6E+00
Heptachlor	50%	5.0E-04	2.5E-04	4.5E+00	9.0E+00
Aldrin	50%	3.0E-05	1.5E-05	1.7E+01	3.4E+01
Heptachlor Epoxide	50%	1.3E-05	6.5E-06	9.1E+00	1.8E+01
Aroclor-1248	50%	--	--	7.7E+00	1.5E+01
Aroclor-1254	50%	2.0E-05	1.0E-05	7.7E+00	1.5E+01

TABLE 6-12 (Continued)

SUMMARY OF DERMALLY ADJUSTED
HEALTH-BASED CRITERIA
SITE 36, CAMP GEIGER AREA DUMP
REMEDIAL INVESTIGATION CTO-0303
MCB, CAMP LEJEUNE, NORTH CAROLINA

Contaminant	Percent Absorbed ⁽¹⁾	Oral RfD mg/kg/d	Dermally-Adjusted Oral RfD, mg/kg/d	Oral CSF (mg/kg/d) ⁻¹	Dermally-Adjusted Oral CSF, (mg/kg/d) ⁻¹
Metals					
Aluminum	20%	1.0E+00	2.0E-01	--	--
Antimony	20%	4.0E-04	8.0E-05	--	--
Arsenic	20%	3.0E-04	6.0E-05	1.5E+00	7.5E+00
Barium	20%	7.0E-02	1.4E-02	--	--
Beryllium	20%	5.0E-03	1.0E-03	4.3E+00	2.2E+01
Cadmium (soil)	20%	1.0E-03	2.0E-04	--	--
Cadmium (water)	20%	5.0E-04	1.0E-04	--	--
Chromium	20%	5.0E-03	1.0E-03	--	--
Cobalt	20%	6.0E-02	1.2E-02	--	--
Copper	20%	4.0E-02	8.0E-03	--	--
Iron	20%	3.0E-01	6.0E-02	--	--
Lead	20%	--	--	--	--
Mercury	20%	3.0E-04	6.0E-05	--	--
Manganese	20%	1.4E-01	2.8E-02	--	--
Molybdenum	20%	5.0E-03	1.0E-03	--	--
Nickel	20%	2.0E-02	4.0E-03	--	--
Selenium	20%	5.0E-03	1.0E-03	--	--
Thallium	20%	8.0E-05	1.6E-05	--	--
Vanadium	20%	7.0E-03	1.4E-03	--	--
Zinc	20%	3.0E-01	6.0E-02	--	--

Notes:

⁽¹⁾ Region IV recommended values (i.e., 80% for VOCs, 50% for SVOCs, and 20% for inorganics)

RfD = USEPA-verified reference dose

CSF = USEPA-verified cancer slope factor

-- = No toxicity value is available or applicable

Dermally-adjusted RfD = oral RfD * percent absorbed

Dermally-adjusted CSF = oral CSF / percent absorbed

TABLE 6-13

SUMMARY OF RISKS FOR THE
MILITARY RECEPTOR
SITE 36, CAMP GEIGER AREA DUMP
REMEDIAL INVESTIGATION CTO-0303
MCB, CAMP LEJEUNE, NORTH CAROLINA

Exposure Pathway	Noncarcinogenic Risk	Carcinogenic Risk
Surface Soil		
Ingestion	7.0E-02	7.3E-07
Dermal Contact	1.8E-02	5.0E-07
Inhalation	9.6E-07	6.5E-09
Total Risk	8.7E-02	1.2E-06

TABLE 6-14

**SUMMARY OF RISKS FOR THE
CHILD TRESPASSER
SITE 36, CAMP GEIGER AREA DUMP
REMEDIAL INVESTIGATION CTO-0303
MCB, CAMP LEJEUNE, NORTH CAROLINA**

Exposure Pathway	Noncarcinogenic Risk	Carcinogenic Risk
Surface Soil		
Ingestion	1.7E-01	2.7E-06
Dermal Contact	2.0E-02	8.4E-07
Inhalation	7.8E-07	7.9E-09
total	1.9E-01	3.5E-06
Surface Water		
Ingestion	1.0E-02	--
Dermal Contact	3.1E-02	--
total	4.1E-02	--
Sediment		
Ingestion	1.5E-01	7.1E-07
Dermal Contact	7.7E-03	6.8E-08
total	1.5E-01	7.8E-07
Current Risk	3.9E-01	4.3E-06

Notes:

-- = Not Applicable

TABLE 6-15

**SUMMARY OF RISKS FOR THE
FUTURE CHILD RESIDENT
SITE 36, CAMP GEIGER AREA DUMP
REMEDIAL INVESTIGATION CTO-0303
MCB, CAMP LEJEUNE, NORTH CAROLINA**

Exposure Pathway	Noncarcinogenic Risk	Carcinogenic Risk
Surface Soil		
Ingestion	9.1E-01	1.4E-05
Dermal Contact	6.2E-02	2.6E-06
Inhalation	3.1E-06	3.2E-08
total	9.7E-01	1.7E-05
Subsurface Soil		
Ingestion	2.2	1.4E-05
Dermal Contact	1.3E-01	1.2E-06
Inhalation	2.8E-06	4.8E-08
total	2.3	1.5E-05
Groundwater		
Ingestion	5.1	1.8E-05
Dermal Contact	7.4E-02	4.8E-07
Inhalation	--	5.0E-07
total	5.2	1.9E-05
Surface Water		
Ingestion	1.0E-02	--
Dermal Contact	2.3E-02	--
total	3.3E-02	--
Sediment		
Ingestion	1.5E-01	7.1E-07
Dermal Contact	8.9E-03	7.8E-08
total	1.6E-01	7.9E-07
Future Risk	8.7	3.5E-05

Notes:

-- = Not Applicable

Bolded values indicate risk values that exceed the acceptable risk value of 1.0 for noncarcinogenic effects.

TABLE 6-16

SUMMARY OF RISKS FOR THE
 ADULT TRESPASSER
 SITE 36, CAMP GEIGER AREA DUMP
 REMEDIAL INVESTIGATION CTO-0303
 MCB, CAMP LEJEUNE, NORTH CAROLINA

Exposure Pathway	Noncarcinogenic Risk	Carcinogenic Risk
Surface Soil		
Ingestion	6.0E-03	4.7E-07
Dermal Contact	3.6E-03	7.5E-07
Inhalation	1.1E-07	5.6E-09
total	9.5E-03	1.2E-06
Surface Water		
Ingestion	2.1E-03	--
Dermal Contact	1.7E-02	--
total	1.9E-02	--
Sediment		
Ingestion	1.6E-02	3.8E-07
Dermal Contact	4.1E-03	1.8E-07
total	2.0E-02	5.6E-07
Current Risk	4.8E-02	1.8E-06

Notes:

-- = Not Applicable

TABLE 6-17

SUMMARY OF RISKS FOR THE
 FUTURE ADULT RESIDENT
 SITE 36, CAMP GEIGER AREA DUMP
 REMEDIAL INVESTIGATION CTO-0303
 MCB, CAMP LEJEUNE, NORTH CAROLINA

Exposure Pathway	Noncarcinogenic Risk	Carcinogenic Risk
Surface Soil		
Ingestion	9.7E-02	7.7E-06
Dermal Contact	3.4E-02	7.0E-06
Inhalation	9.0E-07	4.6E-08
total	1.3E-01	1.5E-05
Subsurface Soil		
Ingestion	2.3E-01	7.5E-06
Dermal Contact	6.9E-02	3.2E-06
Inhalation	7.9E-07	6.9E-08
total	3.0E-01	1.1E-05
Groundwater		
Ingestion	2.2	3.9E-05
Dermal Contact	3.6E-02	1.2E-06
Inhalation	--	4.1E-07
total	2.2	4.1E-05
Surface Water		
Ingestion	2.1E-03	--
Dermal Contact	1.3E-02	--
total	1.5E-02	--
Sediment		
Ingestion	1.6E-02	3.8E-07
Dermal Contact	4.8E-03	2.1E-07
total	2.1E-02	5.9E-07
Future Risk	2.7	6.7E-05

Notes:

-- = Not Applicable

Bolded values indicate risk values that exceed the acceptable risk value of 1.0 for noncarcinogenic effects.

TABLE 6-18

SUMMARY OF RISKS FOR THE
 FISHERMAN RECEPTOR
 SITE 36, CAMP GEIGER AREA DUMP
 REMEDIAL INVESTIGATION CTO-0303
 MCB, CAMP LEJEUNE, NORTH CAROLINA

Exposure Pathway	Noncarcinogenic Risk	Carcinogenic Risk
Surface Water		
Ingestion	2.3E-03	--
Dermal Contact	1.3E-02	--
total	1.6E-02	--
Sediment		
Ingestion	1.7E-02	4.1E-07
Dermal Contact	5.1E-03	2.3E-07
total	2.2E-02	6.3E-07
Fish Ingestion	5.3	5.3E-04
Crab Ingestion	3.8	5.4E-04
Current/Future Risk	9.1	1.1E-03

Notes:

-- = Not Applicable

Bolded values indicate risk values that exceed the acceptable risk value of 1.0 for noncarcinogenic effects or 1×10^{-4} for carcinogenic effects.

TABLE 6-19

SUMMARY OF RISKS FOR THE
 CONSTRUCTION WORKER
 SITE 36, CAMP GEIGER AREA DUMP
 REMEDIAL INVESTIGATION CTO-0303
 MCB, CAMP LEJEUNE, NORTH CAROLINA

Exposure Pathway	Noncarcinogenic Risk	Carcinogenic Risk
Surface Soil		
Ingestion	1.2E-01	3.1E-07
Dermal Contact	6.4E-03	4.5E-08
Inhalation	2.3E-07	3.9E-08
Current Risk	1.3E-01	3.6E-07
Subsurface Soil		
Ingestion	2.9E-01	3.1E-07
Dermal Contact	1.3E-02	2.1E-08
Inhalation	2.0E-07	5.9E-10
subtotal	3.0E-01	3.3E-07
Future Risk	4.3E-01	6.9E-07

TABLE 6-20

SUMMARY OF UNCERTAINTIES IN THE RESULTS OF THE
HUMAN HEALTH RISK ASSESSMENT
SITE 36, CAMP GEIGER AREA DUMP
REMEDIAL INVESTIGATION CTO-0303
MCB, CAMP LEJEUNE, NORTH CAROLINA

	Potential Magnitude for Over-Estimation of Risks	Potential Magnitude for Under-Estimation of Risks	Potential Magnitude for Over or Under-Estimation of Risks
<u>Environmental Sampling and Analysis</u>			
Sufficient samples may not have been taken to characterize the media being evaluated.			Low
Systematic or random errors in the chemical analysis may yield erroneous data.			Low
<u>Selection of COPCs</u>			
The use of USEPA Region III COPC screening concentrations in selecting COPCs in soil and groundwater.			Low
<u>Exposure Assessment</u>			
The standard assumptions regarding body weight, exposure period, life expectancy, population characteristics, and lifestyle may not be representative of the actual exposure situations.			Moderate
The use of the 95th percentile upper confidence level data of the lognormal distribution in the estimation of the RME.			Low
Assessing future residential property use when the likelihood of residential development is low.	High		
The amount of media intake is assumed to be constant and representative of any actual exposure.			Low
<u>Toxicological Assessment</u>			
Toxicological indices derived from high dose animal studies, extrapolated to low dose human exposure.	Moderate		
Lack of promulgated toxicological indices for inhalation pathway.		Low	
<u>Risk Characterization</u>			
Assumption of additivity in the quantitation of cancer risks without consideration of synergism, antagonism, promotion and initiation.			Moderate

TABLE 6-20 (Continued)

SUMMARY OF UNCERTAINTIES IN THE RESULTS OF THE
HUMAN HEALTH RISK ASSESSMENT
SITE 36, CAMP GEIGER AREA DUMP
REMEDIAL INVESTIGATION, CTO-0303
MCB, CAMP LEJEUNE, NORTH CAROLINA

	Potential Magnitude for Over-Estimation of Risks	Potential Magnitude for Under-Estimation of Risks	Potential Magnitude for Over or Under-Estimation of Risks
Assumption of additivity in the estimation of systemic health effects without consideration of synergism, antagonism, etc.			Moderate
Additivity of risks by individual exposure pathways (dermal and ingestion and inhalation).	Low		Low
Compounds not quantitatively evaluated.		Low	

Notes:

Low = Assumptions categorized as "low" may effect risk estimates by less than one order of magnitude.

Moderate = Assumptions categorized as "moderate" may effect estimates of risk by between one and two orders of magnitude.

High = Assumptions categorized as "high" may effect estimates of risk by more than two orders of magnitude.

Source: Risk Assessment Guidance for Superfund, Volume 1, Part A: Human Health Evaluation Manual. USEPA, 1989a.

TABLE 6-21

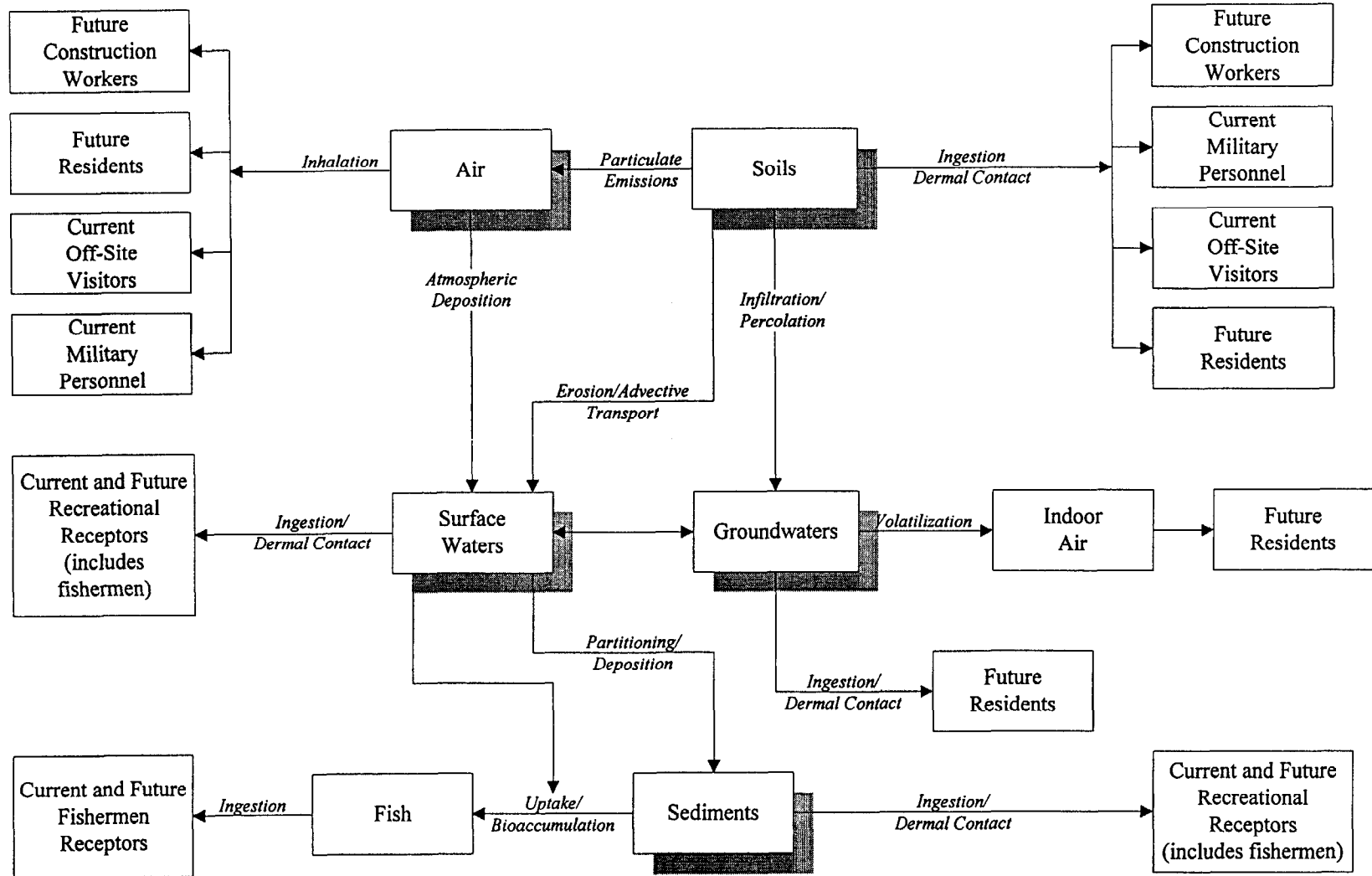
SUMMARY OF CONTAMINANTS CONTRIBUTING TO SITE RISKS
 SITE 36, CAMP GEIGER AREA DUMP
 REMEDIAL INVESTIGATION CTO-0303
 MCAS, NEW RIVER, NORTH CAROLINA

Site and Exposure Medium	Contaminant	Concentration
Site 36 Groundwater	Iron	16.9 mg/L (<i>maximum</i>)
Surface soil	Lead	836 mg/kg (<i>maximum</i>)
Subsurface Soil	Lead Iron	2,680 mg/kg (<i>maximum</i>) 31,267 mg/kg (<i>lognormal UCL</i>)
Crab Tissue	Arsenic Lead	14 mg/kg (<i>maximum</i>) 0.61 mg/kg (<i>maximum</i>)
Fish Tissue	Arsenic Mercury	1 mg/kg (<i>lognormal UCL</i>) 1 mg/kg (<i>lognormal UCL</i>)

SECTION 6.0 FIGURES

FIGURE 6-1

FLOWCHART OF POTENTIAL EXPOSURE PATHWAYS AND RECEPTORS
SITE 36: CAMP GEIGER AREA DUMP



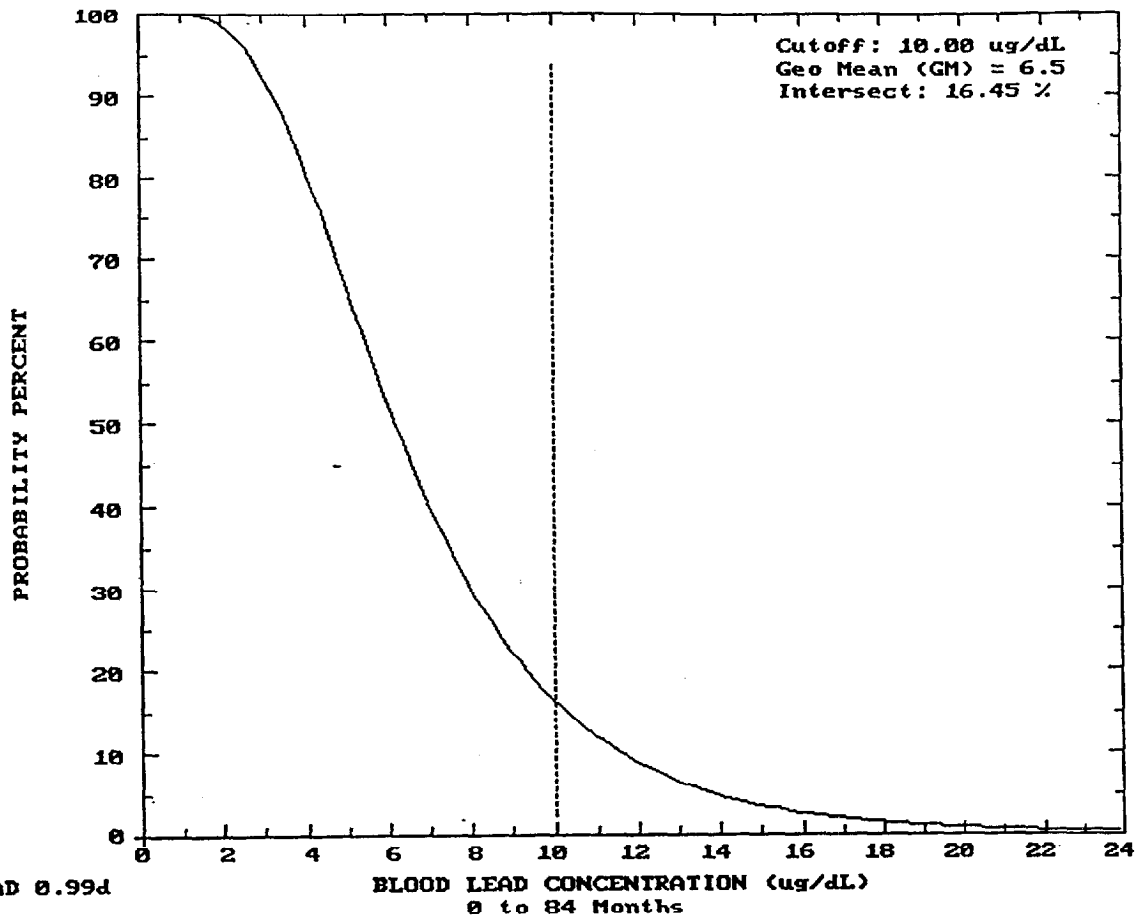
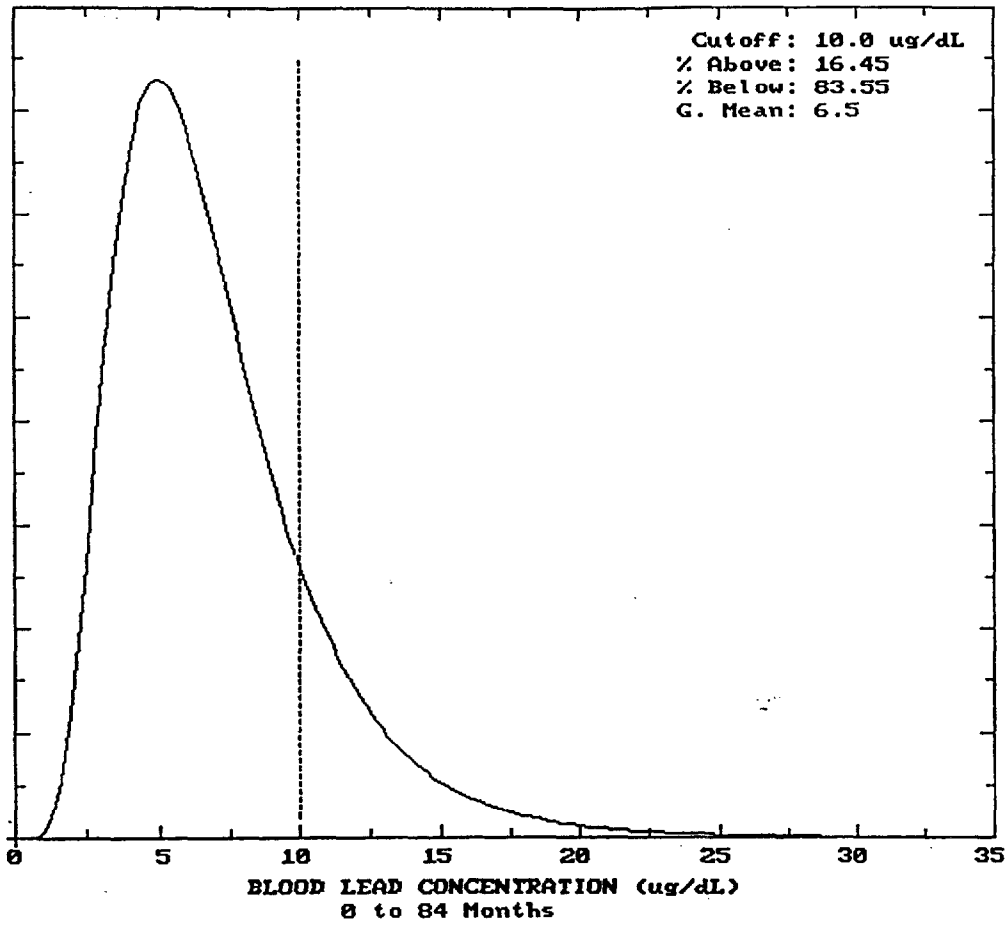


Figure 6-2
Cumulative Probability Percent of Blood Lead Levels
Site 36 Surface Soil Exposure

Probability Density
Function f (blood Pb)



AD 0.99d

Figure 6-3
Probability Distribution of Blood Lead Levels
Site 36 Surface Soil Exposure

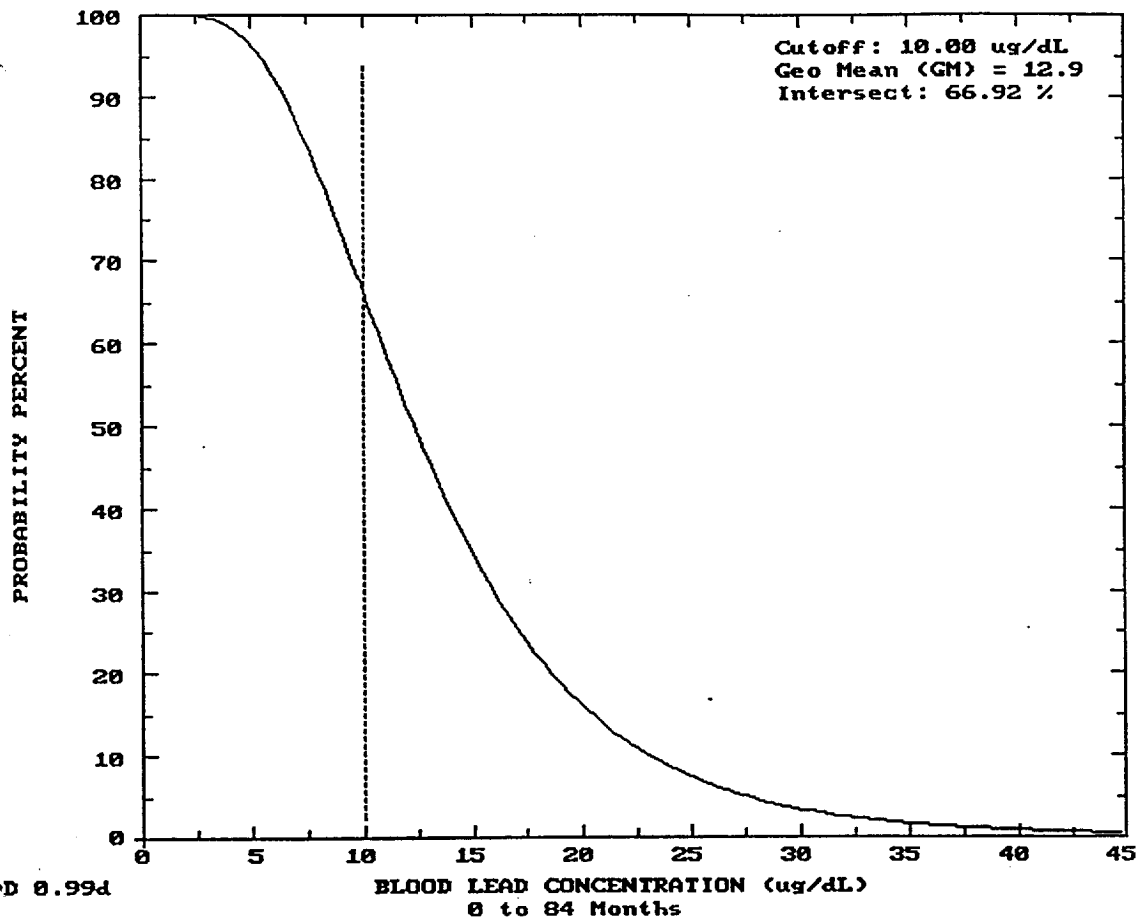
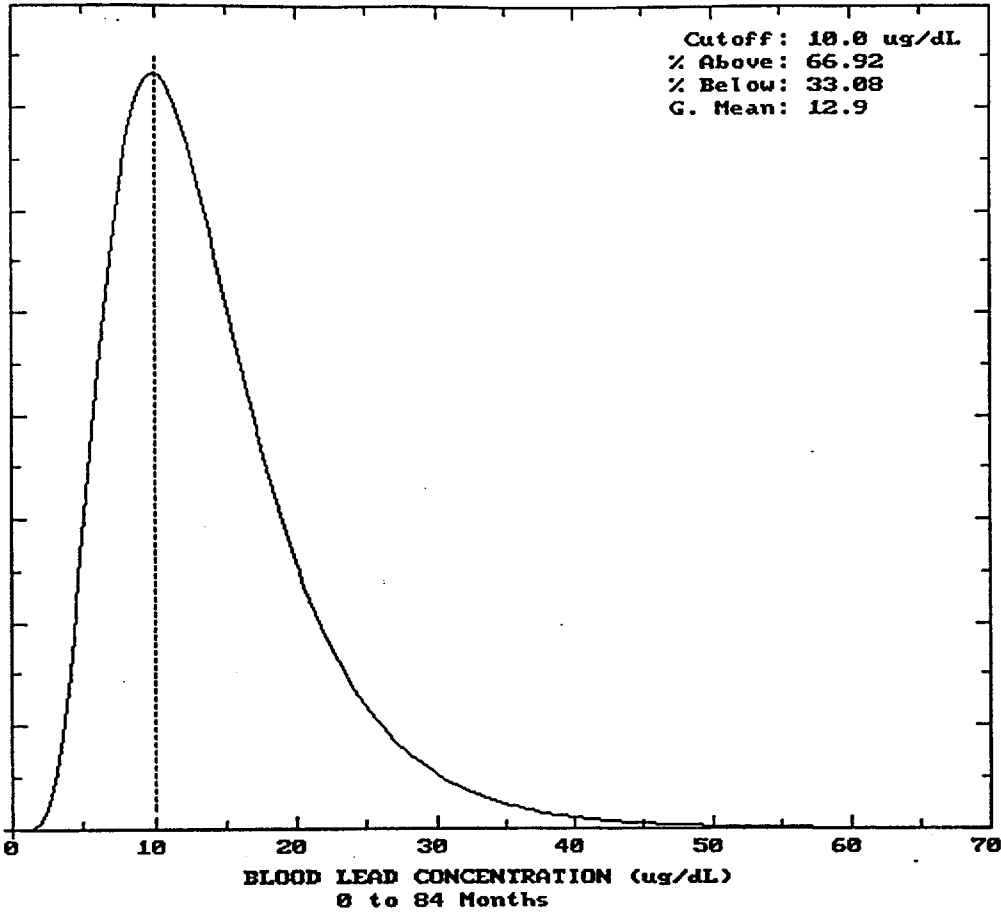


Figure 6-4
Cumulative Probability Percent of Blood Lead Levels
Site 36 Subsurface Soil Exposure

Probability Density
Function f (blood Pb)



LEAD 0.99d

Figure 6-5
Probability Distribution of Blood Lead Levels
Site 36 Subsurface Soil Exposure

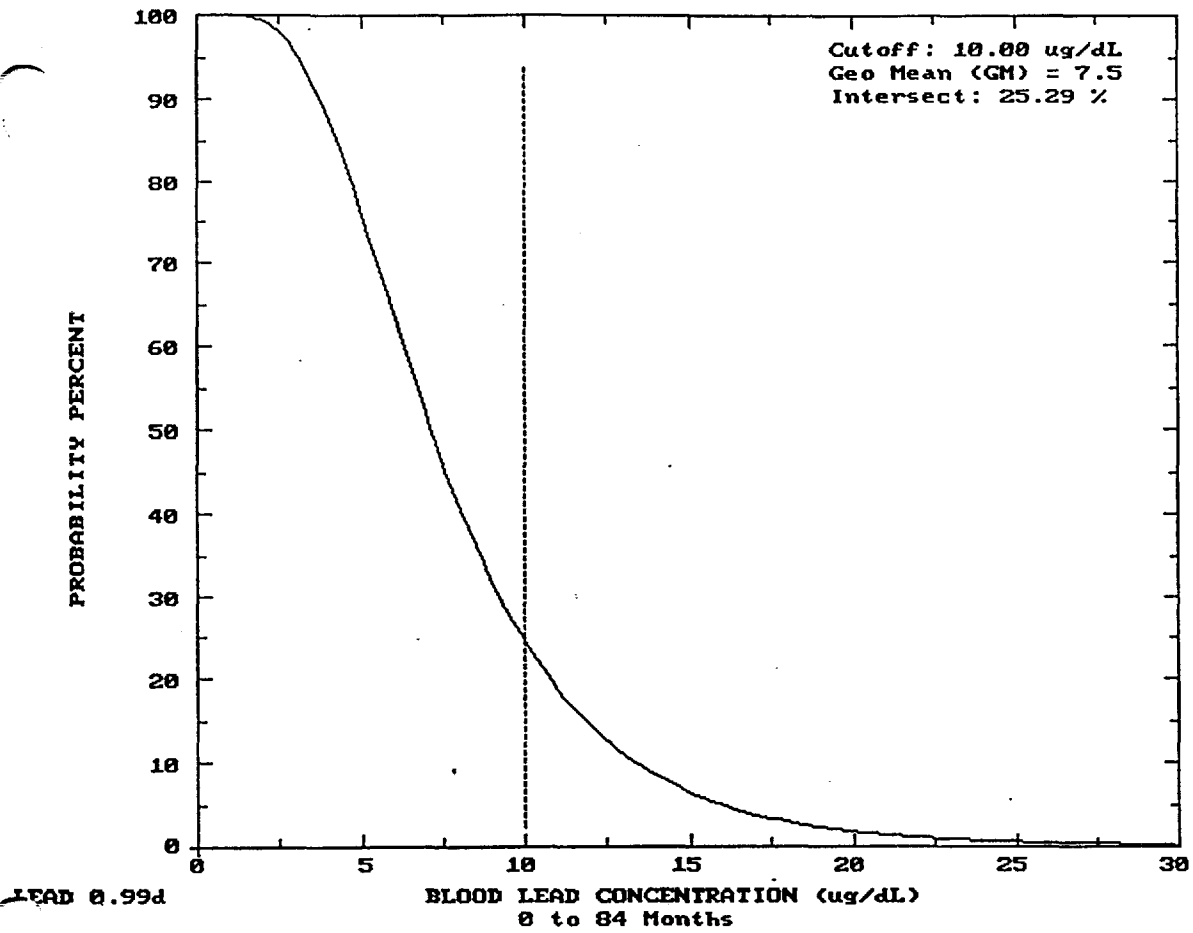


Figure 6-6
 Cumulative Probability Percent of Blood Lead Levels
 Site 36 Crab Tissue Exposure

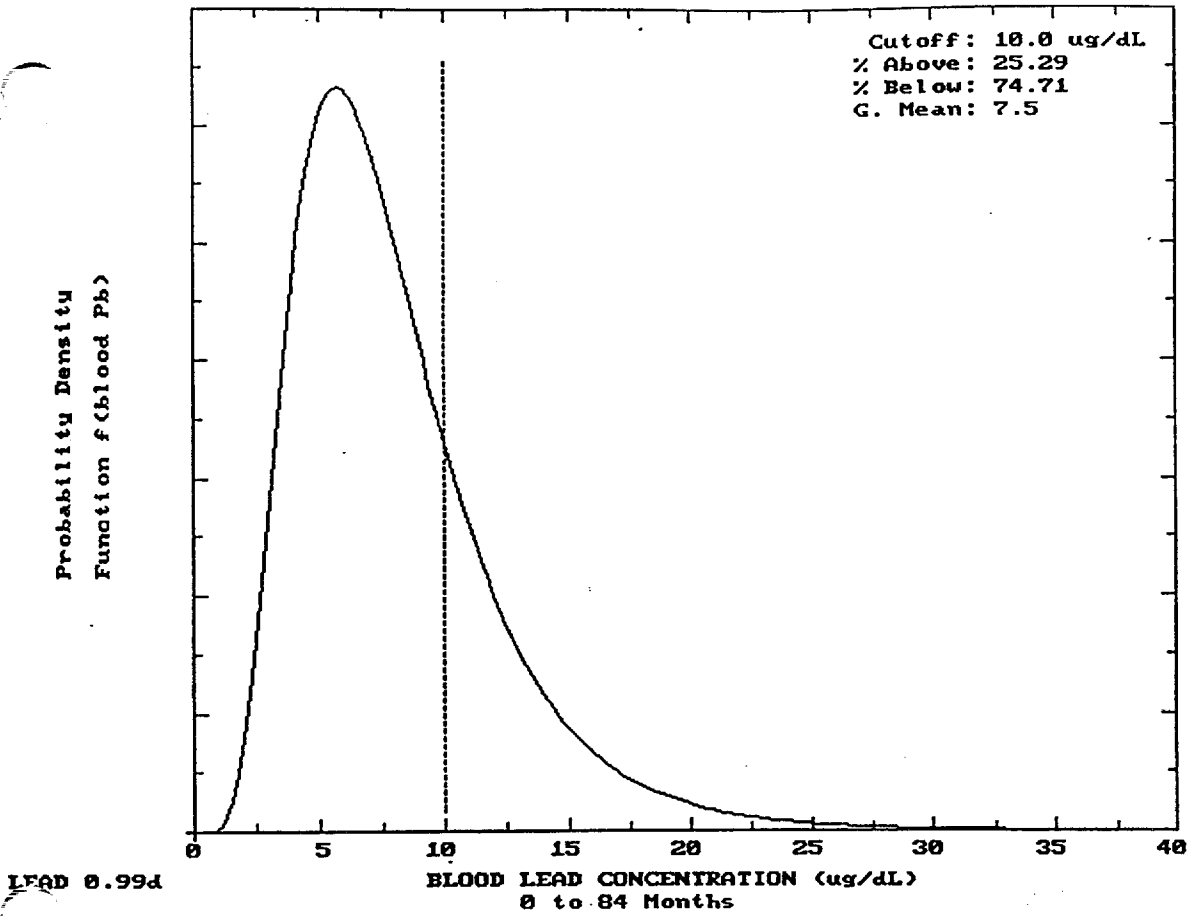


Figure 6-7
Probability Distribution of Blood Lead Levels
Site 36 Crab Tissue Exposure

7.0 ECOLOGICAL RISK ASSESSMENT

The Comprehensive Environmental Response, Compensation, and Liability Act of 1980 (CERCLA) as amended by the Superfund Amendments and Reauthorization Act (SARA) of 1986, directs USEPA to protect human health and the environment with respect to releases or potential releases of contaminants from abandoned hazardous waste sites (USEPA, 1989a). This section of the report presents the ecological risk assessment (ERA) conducted at Operable Unit No. 6, Site 36 that assesses the potential impacts to ecological receptors from contaminants detected at this site.

7.1 Objectives, Scope, and Organization of the Ecological Risk Assessment

The objective of this ERA is to evaluate if past reported disposal practices at Site 36 are potentially adversely impacting the terrestrial and aquatic communities on, or adjacent to, the site. This assessment also evaluates the potential effects of contaminants related to Site 36 on sensitive environments including wetlands, protected species, and fish nursery areas. The conclusions of the ERA are used in conjunction with the human health risk assessment to evaluate the appropriate remedial action for this site for the overall protection of public health and the environment.

This ERA evaluates and analyzes the results from the Remedial Investigation (RI) including chemical analysis of the soil, groundwater, surface water, and sediment. In addition, fish and crabs were collected and chemically analyzed and benthic macroinvertebrate samples were collected and identified. Surface water, sediment, fish, crab, and benthic macroinvertebrate samples that were collected upstream of Site 36, also are evaluated in this ERA.

Information used to evaluate sensitive environments is obtained from historical data and previous studies obtained in the literature, or through conversations with appropriate state, federal, and local personnel.

The media of concern for this ERA are the surface soil, surface water, sediment, and biota tissue. If potential risks are characterized for the ecological receptors, further ecological evaluation of the site and surrounding areas may be warranted.

The risk assessment methodologies used in this evaluation are consistent with those outlined in the Ecological Risk Assessment Guidance for Superfund: Process for Designing and Conducting Ecological Risk Assessments (USEPA, 1994) and Framework for Ecological Risk Assessment (USEPA, 1992). In addition, information found in the following documents was used to supplement the USEPA guidance document:

- USEPA Supplemental Risk Assessment Guidance for Superfund, Volume II, Environmental Evaluation Manual (USEPA, 1989b)
- Ecological Assessment of Hazardous Waste Sites: A Field and Laboratory Reference (USEPA, 1989c)
- Macroinvertebrate Field and Laboratory Methods for Evaluating the Biological Integrity of Surface Waters (USEPA, 1990)
- Fish Field and Laboratory Methods for Evaluating the Biological Integrity of Surface Waters (USEPA, 1993a)

Based on the USEPA Framework for Ecological Risk Assessment, an ERA consists of three main components: 1) Problem Formulation; 2) Analysis; and, 3) Risk Characterization (USEPA, 1992). The problem formulation section includes a preliminary characterization of exposure and effects of the stressors to the ecological receptors. During the analysis, the data is evaluated to determine the exposure and potential effects on the ecological receptors from the stressors. Finally, in the risk characterization, the likelihood of adverse effects occurring as a result of exposure to a stressor is evaluated. This section also evaluates the potential impact on the ecological integrity at the site from the contaminants detected in the media. This ERA is organized to parallel these three components.

7.2 Problem Formulation

Problem formulation is the first step of an ERA and includes a preliminary characterization of exposure and effects (USEPA, 1992). Chemical analyses were performed on samples collected from the soil, groundwater, surface water, sediment, fish, and crabs to evaluate the presence, concentrations, and variabilities of the contaminants. Ecological surveys and a habitat characterization also were conducted as part of the field activities. Based on these observations, potential ecological receptors were identified. Finally, toxicological information for the contaminants detected in the media was obtained from available references and literature and used to evaluate the potential adverse ecological effects to the ecological receptors.

The components of the problem formulation include identifying the stressors and their potential ecological effects, identification of ecosystems potentially at risk, defining ecological endpoints and presenting a conceptual model. The following sections discuss each of these components, and how they are evaluated in this ERA.

7.3 Contaminants of Potential Concern

One of the initial steps in the problem formulation stage of an ERA is identifying the stressors and their potential ecological effects. For this ERA, the stressors that are evaluated include contaminants detected in the surface soil, surface water, sediment, fish and crabs.

Contaminants in the subsurface soil and groundwater are not evaluated in this ERA. Some terrestrial species burrow in the subsurface soil, and microorganisms most likely exist in the groundwater. However, current guidance does not provide sufficient information to evaluate risk to these receptors.

The nature and extent of contaminants detected in the environmental media at Site 36 are presented in Section 4.0 of this report. Sample locations are based on available historical site information and a site visit to evaluate potential ecosystems and ecological receptors.

7.3.1 Criteria for Selecting Contaminants of Potential Concern

Quantifying risk for all positively identified contaminants may distract from the dominant risk-driving contaminants at the site. Therefore, the data set was reduced to a list of contaminants of potential concern (COPCs). COPCs are site-related contaminants used to quantitatively estimate ecological exposures and associated potential ecological effects.

The criteria used in selecting the COPCs from the contaminants detected during the field sampling and analytical phase of the investigation are:

- Historical information
- Prevalence
- Toxicity
- Comparison to federal and state criteria and standards
- Comparison to investigation associated field and laboratory blank data
- Comparison to background or naturally occurring levels
- Comparison to anthropogenic levels

7.3.1.1 Historical Information

Using historical information to associate contaminants with site activities, when combined with the following selection procedures, helps determine contaminant retention or elimination. To be conservative, contaminants detected in the surface soil, surface water, and sediment that may not have been historically used at a site are retained as COPCs to evaluate risk, but may be eliminated in the ecological significance section as not being site-related. Contaminants detected in the tissue samples that are not detected in any of the surface water or sediment samples (including those collected in Brinson Creek upstream of Site 36) are not retained as COPCs. Appendix W contains the positive detection summaries of the upstream surface water and sediment samples.

7.3.1.2 Prevalence

The frequency of positive detections in sample sets and the level at which a contaminant is detected in a given medium are factors that determine a chemical's prevalence. Contaminants that were detected infrequently are not retained as COPCs.

7.3.1.3 Toxicity

The potential toxicity of a contaminant is an important consideration when selecting COPCs for further evaluation in the ERA. Several of the contaminants detected in the media at Site 36 are prevalent, however, their inherent toxicity to aquatic and terrestrial receptors is low (e.g., calcium, magnesium, potassium, and sodium). Therefore, they are not retained as COPCs. In addition, several contaminants have not been adequately studied to develop published toxicity values, or even accepted toxicological data with which to assess the contaminants. Contaminants that fall into this category are retained as COPCs (if they are not eliminated due to other criteria), however, they are not quantitatively evaluated in the ERA.

7.3.1.4 State and Federal Criteria and Standards

Water Quality Standards (WQS) for surface water have been developed for North Carolina (NC DEHNR, 1994). These are the only enforceable surface water standards. In addition to the WQS, Water Quality Screening Values (WQSVs) have been developed by USEPA Region IV (USEPA, 1995a), USEPA Region III (USEPA, 1995b), and Oak Ridge National Laboratory (ORNL) (Suter and Mabrey, 1994). The WQS and WQSVs will be herein referred to as Surface Water Screening Values (SWSVs).

Sediment quality standards have not been developed for North Carolina. However, Sediment Screening Values (SSVs) are available for many contaminants. These SSVs include the following: Sediment Screening Levels (SSLs) (Long et. al., 1995; Long and Morgan, 1991; and, USEPA, 1995b), calculated sediment quality criteria (SQC) (USEPA, 1993b), Apparent Effect Threshold values (AET) (Tetra-Tech, Inc., 1986), and Wisconsin Department of Natural Resources interim guidance criteria for in-water disposal of dredged sediments (Sullivan, et. al., 1985).

The SWSVs and SSVs are used for comparative purposes to infer potential ecological risks. Contaminants that were detected at concentrations less than these screening values are not retained as COPCs for aquatic receptors since contaminants detected at concentrations less than these values are not expected to pose a significant risk to the aquatic receptor population. However, these contaminants may be retained as COPCs for the terrestrial receptors.

There are no state or federal soil screening values that can be used to evaluate potential ecological risks to terrestrial receptors (other than plants or invertebrates). Therefore, toxicity of contaminants in the surface soil to terrestrial receptors is not used as criteria for retaining COPCs except for calcium, magnesium, potassium, and sodium, which are not retained as COPCs in any of the media.

There are no state or federal biota tissue screening values that can be used to evaluate potential ecological risks to aquatic receptors such as fish and crabs. Therefore, toxicity of contaminants in the tissue samples to aquatic receptors is not used as criteria for retaining COPCs except for calcium, magnesium, potassium, and sodium, which are not retained as COPCs in any of the media.

A brief explanation of the standards, criteria, and screening values used for the evaluation of the COPCs is presented below.

North Carolina Water Quality Standards (Surface Water) - WQS are the concentrations of toxic substances that will not result in chronic toxicity to aquatic life (NC DEHNR, 1994). WQS are provided for both freshwater and saltwater aquatic systems.

USEPA Water Quality Screening Values - WQSVs are non-enforceable regulatory guidelines and are of primary utility in assessing acute and chronic toxic effects in aquatic systems. WQSVs are provided for both freshwater and saltwater aquatic systems, and are reported as acute and/or chronic values (USEPA, 1995a,b). Most of the WQSVs are the same as the USEPA Ambient Water Quality Criteria (AWQC), however, some of the WQSVs are based on more current studies.

Oak Ridge National Laboratory Aquatic Benchmarks - ORNL Aquatic Benchmarks are developed for many contaminants, including those that do not have WQS or WQSVs (Suter and Mabrey, 1994). The ORNL aquatic benchmarks include secondary acute values and secondary chronic values that are calculated using the Tier II method described in the EPA's Proposed Water Quality Guidance for the Great Lakes System (USEPA, 1993c). Tier II values are developed so that aquatic benchmarks could be established with fewer data than are required for the USEPA AWQC. The benchmarks are limited to contaminants in freshwater.

Sediment Screening Levels - Sediment Screening Levels (SSLs) have been compiled to evaluate the potential for contaminants in sediments to cause adverse biological effects (Long, et. al., 1995; Long and Morgan 1991; and, USEPA, 1995b). The lower ten percentile (Effects Range-Low [ER-L]) and the median percentile (Effects Range-Median [ER-M]) of biological effects have been developed for several contaminants. The concentration below the ER-L represents a minimal-effects

range (adverse effects would be rarely observed). The concentration above the ER-L but below the ER-M represents a possible-effects range (adverse effects would occasionally occur). Finally, the concentration above the ER-M represents a probable-effects range (adverse effects would probably occur).

In addition to the SSLs, Apparent Effects Threshold (AET) Sediment Quality Values have been developed by Tetra Tech Inc., (1986) for the Puget Sound. AETs are the concentrations of contaminants above which statistically significant biological effects would always be expected. Finally, the Wisconsin Department of Natural Resources has developed interim criteria for in-water disposal of dredged sediments (Sullivan, et. al., 1985). However, these criteria are established using background data and are not based on aquatic toxicity.

Sediment Quality Criteria - Currently, promulgated sediment quality criteria (SQC) only exist for a few contaminants. However, SQC for nonionic organic compounds can be calculated using the procedures in the Technical Basis for Deriving Sediment Quality Criteria for Nonionic Organic Contaminants for the Protection of Benthic Organisms by using Equilibrium Partitioning (USEPA, 1993b) as follows:

$$SQC = (Foc)(Koc)(FCV)/1,000,000$$

Where:

- SQC = sediment quality criteria ($\mu\text{g}/\text{kg}$)
- Foc = sediment organic carbon content (mg/kg)
- Koc = chemical organic carbon partition coefficient (mL/g)
- FCV = final chronic water quality value ($\mu\text{g}/\text{L}$)

7.3.1.5 Field and Laboratory Blank Data

Associating contaminants detected in field related blanks (i.e., trip blanks, equipment rinsates and/or field blanks) or laboratory method blanks with the same contaminants detected in analytical samples can eliminate non-site-related contaminants from the list of COPCs. Blank data should be compared to sample results with which the blanks are associated. However, for this data set it is difficult to associate specific blanks with specific environmental samples. Thus, in order to evaluate detection levels, maximum contaminant concentrations reported in a given set of blanks are applied to a corresponding set of samples.

In accordance with the National Functional Guidelines for Organics, common lab contaminants (i.e., acetone, 2-butanone, methylene chloride, toluene, and phthalate esters) should be regarded as a direct result of site activities only when sample concentrations exceed 10 times the maximum blank concentration. For other contaminants not considered common in a lab, concentrations exceeding 5 times the maximum blank concentration indicates contamination resulting from site activities (USEPA, 1991a).

Contract Required Quantitation Limits (CRQLs) and percent moisture are employed when evaluating contaminant concentrations in soil, in order to correlate solid and aqueous detection limits. For example, the CRQL for semivolatiles in soil is 33 to 66 times that of aqueous samples, depending on the contaminant. In order to assess semivolatile contaminant levels in soil using aqueous blanks, the blank concentration must then also be multiplied by 33 or 66 to account for

variance from the CRQL (common lab contaminants must first be multiplied by 5 or 10, as explained in the paragraph above). The final value is divided by the sample percent moisture.

Eliminating a sample result correlates directly to a reduction in the contaminant prevalence in that medium. Consequently, if elimination due to blank concentration reduces the prevalence of a contaminant to less than 5 percent, a contaminant that may have been included according to its prevalence is eliminated as a COPC.

Maximum concentrations of common laboratory contaminants detected in blanks are presented in Section 6.0, Table 6-1. Blanks containing organic constituents that are not considered common laboratory contaminants (i.e., all other TCL compounds) are regarded as positive results only when observed concentrations exceed 5 times the maximum concentration detected in any blank (USEPA, 1989a). All TCL compounds at less than 5 times the maximum level of contamination noted in any blank are considered not detected in that sample.

7.3.1.6 Background or Naturally Occurring Levels

Contaminants that were detected in the surface soil at concentrations less than two-times the average Base background concentration are not retained as COPCs. Off-site surface water and sediment samples were collected from several water bodies in the White Oak River water basin during a background study (see Appendix V). The contaminant in the off-site samples and the site stations are compared to each other to determine if contaminant concentrations in the site stations are below naturally occurring regional levels.

The two water bodies sampled at Site 36 were Brinson Creek and an unnamed tributary to Brinson Creek. The majority of the samples are freshwater or slightly tidally influenced. Therefore, the freshwater off-site background surface water and sediment samples are compared to the Site 36 samples to determine if contaminant concentrations are within background concentrations. This is a conservative approach because most of the contaminants in the freshwater off-site background samples were detected at lower concentrations than they were detected in the mid-stream saltwater off-site background samples. Contaminants that were detected in the surface water or sediment at concentrations less than the average background concentration are not retained as COPCs.

7.3.1.7 Anthropogenic Levels

Ubiquitous anthropogenic background concentrations result from non-site related sources such as combustion of fossil fuels (i.e., automobiles), plant synthesis, natural fires and factories. Examples of ubiquitous, anthropogenic chemicals are polycyclic aromatic hydrocarbons (PAHs). Anthropogenic chemicals are typically not eliminated as COPCs without considering other selection criteria. It is difficult to determine that such chemicals are present at the site due to operations not related to the site or the surrounding area. Omitting anthropogenic background chemicals from the risk assessment may result in the loss of important information for those potentially exposed.

The following sections apply the aforementioned selection criteria beginning with the prevalence of detected analytical results in each medium of interest to establish a preliminary list of COPCs for Site 36. Once this task has been completed, a final list of media-specific COPCs will be selected based on the remaining criteria.

7.3.2 Selection of Contaminants of Potential Concern

The following sections present an overview of the analytical data obtained for each medium during the RI and the subsequent retention or elimination of COPCs using the aforementioned selection criteria. Contaminants that were not eliminated due to the above criteria were retained as COPCs. The primary reasons for retaining contaminants as COPCs include, but may not be limited to the following: (1) frequently detected, (2) detected at concentrations above the screening values (if available) and/or (3) detected at concentrations above background (if available). In addition, some common laboratory contaminants (i.e., phthalates, acetone, 2-butanone) are retained as COPCs because they were detected frequently and were not detected in the blank samples. Calcium, magnesium, potassium, and sodium are not retained as COPCs in any of the media because they are common naturally occurring chemicals, are not related to the site, and no published toxicity data was identified to assess potential impacts to aquatic or terrestrial life.

Tables 7-1 through 7-4 present the comparison of the surface water contaminant concentrations to the SWSVs and the off-site sample contaminant concentrations. Tables 7-5 and 7-6 present the comparison of the sediment contaminant concentrations to applicable SSVs and the off-site sample contaminant concentrations. A comparison of the surface soil contaminant concentrations to base-background concentrations is presented in Section 6.0, Table 6-3. A summary of the COPCs in each media is presented in Table 7-7. Appendix W contains the positive detection summary for the upstream surface water and sediment samples.

7.3.2.1 Surface Soil

Sixty-one surface soil samples were collected at Site 36. All sixty-one samples were analyzed for TCL VOCs, fifty-seven samples were analyzed for TCL SVOCs and TCL pesticides/PCBs, and fifty-two samples were analyzed for TAL metals.

Six VOCs were detected in the surface soil. Acetone, styrene, tetrachloroethene, trichloroethene, and xylenes are not retained as COPCs because they were detected in less than five percent of the samples (1/61, 2/61, or 3/61). Toluene is the only VOC retained as a COPC.

Twenty-one SVOCs were detected in the surface soil. Acenaphthene, anthracene, benzo(a)anthracene, benzo(k)fluoranthene, benzo(a)pyrene, benzo(g,h,i)perylene, carbazole, chrysene, dibenzo(a,h)anthracene, dibenzofuran, fluorene, 2-methylnaphthalene, naphthalene, and n-nitro-di-n-propylamine are not retained as COPCs because they were detected in less than five percent of the samples (1/57 or 2/57). The remaining seven SVOCs [benzo(b)fluoranthene, bis(2-ethylhexyl)phthalate, butylbenzylphthalate, fluoranthene, indeno(1,2,3-cd)pyrene, phenanthrene and pyrene] are retained as COPCs.

Fifteen pesticides and two PCBs were detected in the surface soil. Gamma-BHC, endosulfan sulfate, endrin, endrin aldehyde, endrin ketone, and heptachlor are not retained as COPCs because they were detected in less than five percent of the samples (1/52). The remaining nine pesticides (aldrin, alpha-chlordane, gamma-chlordane, 4,4'-DDD, 4,4'-DDE, 4,4'-DDT, dieldrin, endosulfan I, and heptachlor epoxide) are retained as COPCs. Two PCBs were detected in the surface soil. Both PCBs (Aroclor-1248 and Aroclor-1254) are retained as COPCs.

Twenty-two metals were detected in the surface soil. Beryllium is not retained as a COPC because it was detected in less than five percent of the samples (1/52). As presented above, calcium,

magnesium, potassium, and sodium are not retained as COPCs. The remaining seventeen metals (aluminum, antimony, arsenic, barium, cadmium, chromium, cobalt, copper, iron, lead, manganese, mercury, nickel, selenium, silver, vanadium, and zinc) are retained as COPCs.

7.3.2.2 Surface Water

Seven surface water samples were collected at Site 36. Three of these samples were collected in freshwater locations (36-SW01 through 36-SW03) and four were collected at saltwater locations (36-SW04 through 36-SW07). It should be noted that the dissolved metal surface water samples were collected approximately one year after collection of the total metal surface water samples (total metal samples were collected during the RI field program for Site 35). The dissolved metal surface water samples were collected since dissolved metals are more bioavailable to aquatic receptors. Total and dissolved metals are retained as COPCs for the aquatic receptors at Site 36. Only the total metals are retained as COPCs for the terrestrial receptors, since they will be ingesting the total contaminant portion of the surface water. All the surface water samples were analyzed for TCL VOCs, SVOCs, and pesticides/PCBs, and TAL metals.

Since part of the sample locations are tidally influenced (36-SW04 through 36-SW07), the contaminant concentrations in the surface water and sediment are compared to the saltwater screening values. The remaining samples (36-SW01 through 36-SW03) are not tidally influenced and, therefore, the contaminant concentrations in the surface water and sediment are compared to the freshwater screening values. Several of the metals' criteria are hardness dependent (cadmium, copper, lead, nickel, and zinc). The lowest hardness values were used to calculate the freshwater SWSVs since they produce the most conservative screening values. A hardness of 74 mg/L CaCO₃ was used for the total contaminants, while a hardness of 26 mg/L CaCO₃ was used for the dissolved contaminants. Appendix X presents the hardness calculations.

Freshwater Surface Water Stations

One VOC [1,2-dichloroethene (total)] was detected in the surface water. 1,2-dichloroethene(total) was not retained as a COPC for the aquatic receptors because it was detected at a concentration below the SWSV. No SVOCs or pesticide/PCBs were detected in the freshwater surface water.

Thirteen metals (total) were detected in the freshwater surface water. Aluminum is not retained as a COPC for either the aquatic or terrestrial receptors because it was detected below the concentration in the off-site background surface water. Antimony, molybdenum, and nickel are not retained as COPCs for the aquatic receptors because they were detected at concentrations below the SWSVs. As presented above, calcium, magnesium, potassium, and sodium are not retained as COPCs for either the aquatic or terrestrial receptors. The remaining five metals (barium, copper, iron, manganese and vanadium) are retained as COPCs for both the aquatic and terrestrial receptors.

Fourteen metals (dissolved) were detected in the surface water. Aluminum, nickel, and zinc are not retained as COPCs for the aquatic receptors because they were detected at concentrations below the SWSVs. As presented above, calcium, magnesium, potassium, and sodium are not retained as COPCs for the aquatic receptors. The remaining seven metals (barium, cobalt, copper, iron, lead, manganese and vanadium) are retained as COPCs for the aquatic receptors.

Saltwater Surface Water Stations

No VOCs, SVOCs, or pesticides/PCBs were detected in the saltwater surface water.

Twelve metals (total) were detected in the saltwater surface water. Aluminum is not retained as a COPC for either the aquatic or terrestrial receptors because it was detected below the concentration in the off-site background surface water. Antimony, thallium, and vanadium are not retained as COPCs for the aquatic receptors because they were detected at concentrations below the SWSVs. As presented above, calcium, magnesium, potassium, and sodium are not retained as COPCs for either the aquatic or terrestrial receptors. The remaining four metals (iron, manganese, molybdenum, and nickel) are retained as COPCs for both the aquatic and terrestrial receptors.

Thirteen metals (dissolved) were detected in the saltwater surface water. Cadmium, lead, vanadium, and zinc are not retained as COPCs for the aquatic receptors because they were detected at concentrations below the SWSVs. As presented above, calcium, magnesium, potassium, and sodium are not retained as COPCs for the aquatic receptors. The remaining five metals (aluminum, barium, copper, iron, and manganese) are retained as COPCs for the aquatic receptors.

7.3.2.3 Sediment

Fifteen sediment samples were collected at Site 36. Five of these samples were collected in freshwater locations (36-SD01 through 36-SD03) and ten were collected at saltwater locations (36-SD04 through 36-SD07). At each station, sediment samples were collected from two depths, 0 to 6 inches and 6 to 12 inches. The only exception was Station 36-SD01 where the 6 to 12 inch samples could not be collected due to refusal. Thirteen sediment samples were analyzed for TCL VOCs, SVOCs, and pesticides/PCBs, and total organic carbon (TOC), while fifteen samples were analyzed for TAL metals. The two additional samples analyzed for metals were collected to further investigate a high lead detection in one of the sediment samples.

The lowest TOC values were used to calculate the freshwater SSVs since they produce the most conservative screening values. A TOC value of 2,600 mg/L is used to calculate the freshwater SQC values, while a TOC of 2,100 mg/kg is used to calculate the saltwater SQC values. Appendix X presents the SQC calculations.

It should be noted that none of the contaminants in the sediment are retained as COPCs for the terrestrial receptors because current guidance does not exist to evaluate this pathway.

Freshwater Sediment

No VOCs were detected in the freshwater sediment. Three SVOCs were detected in the sediment. Bis(2-ethylhexyl)phthalate and pyrene are not retained as COPCs because they do not exceed their respective SSVs. The remaining SVOC (diethylphthalate) is retained as a COPC.

Nine pesticides were detected in the freshwater sediment. Aldrin and dieldrin are not retained as COPCs because they were detected at concentrations below the concentrations in the off-site background samples. The remaining seven pesticides (4,4'-DDD, 4,4'-DDE, 4,4'-DDT, endosulfan sulfate, endrin, endrin aldehyde, and endrin ketone) are retained as COPCs.

Nineteen metals were detected in the freshwater sediment. Arsenic, barium, chromium, iron, manganese, and zinc are not retained as COPCs because they do not exceed their respective SSVs. As presented above, calcium, magnesium, potassium, and sodium are not retained as COPCs. The remaining nine metals (aluminum, beryllium, cadmium, cobalt, copper, lead, nickel, thallium, and vanadium), are retained as COPCs.

Saltwater Sediment

Tetrachloroethene was the only VOC detected in the saltwater sediment. It is not retained as a COPC because it does not exceed the SSV. Three SVOCs were detected in the sediment. Anthracene and di-n-butylphthalate are not retained as COPCs because they did not exceed their respective SSVs. The remaining SVOC (diethylphthalate) is retained as a COPC.

Six pesticides were detected in the saltwater sediment. The pesticides 4,4'-DDD, 4,4'-DDE, 4,4'-DDT, alpha-chlordane, dieldrin, and endrin aldehyde all are retained as COPCs.

Twenty-one metals were detected in the saltwater sediment. Arsenic, barium, chromium, copper, iron, manganese, nickel, selenium, and zinc are not retained as COPCs because they do not exceed their respective SSVs. As presented above, calcium, magnesium, potassium, and sodium are not retained as COPCs. The remaining eight metals (aluminum, beryllium, cadmium, cobalt, lead, mercury, thallium, and vanadium) are retained as COPCs.

7.3.2.4 Tissue Samples

Nineteen fish fillet samples, eleven fish whole body samples, and three crab (edible portions) samples were collected from Brinson Creek. Some of the tissue samples did not contain enough sample volume to conduct all the requested analyses. Therefore, there are different sample frequencies within each sample grouping. Contaminants detected in the tissue samples that were not detected in any of the surface water or sediment samples collected in Brinson Creek are not retained as COPCs in the tissue samples. All the remaining contaminants (except calcium, magnesium, potassium, and sodium) are retained as COPCs.

Fish Fillet Samples

Nineteen fish fillet samples were collected for tissue analysis. All nineteen samples were analyzed for TCL SVOCs, pesticides/PCBs, and TAL metals, while fifteen samples were analyzed for TCL VOCs (the laboratory did not have enough tissue to analyze four samples for VOCs).

Five VOCs were detected in the fish fillet tissue. Acetone, 2-butanone, carbon disulfide, and methylene chloride are not retained as COPCs because they were not detected in any of the surface water or sediment samples. Toluene is the only VOC retained as a COPC. No SVOCs were detected in the fish fillet samples.

Fourteen pesticides were detected in the fish fillet tissue. All the pesticides (aldrin, beta-BHC, gamma-BHC, alpha-chlordane, 4,4'-DDD, 4,4'-DDE, 4,4'-DDT, dieldrin, endosulfan II, endrin, endrin aldehyde, endrin ketone, heptachlor, heptachlor epoxide) are retained as COPCs.

Seventeen metals were detected in the fish fillet tissue. Silver is not retained as a COPC because it was not detected in the surface water or sediment. As presented above, calcium, magnesium,

potassium, and sodium are not retained as COPCs. The remaining twelve metals (aluminum, arsenic, barium, cadmium, chromium, copper, iron, manganese, mercury, selenium, vanadium, and zinc) are retained as COPCs.

Fish Whole Body Samples

Eleven fish whole body samples were collected for tissue analysis as follows: all eleven samples were analyzed for TCL SVOCs and pesticides/PCBs; ten samples were collected for TAL metals; and, seven samples were analyzed for TCL VOCs.

Six VOCs were detected in the fish whole body tissue. Acetone, 1,1-dichloroethane, carbon disulfide, methylene chloride, and xylenes are not retained as COPCs because they were not detected in any of the surface water or sediment samples. Toluene is the only VOC retained as a COPC. No SVOCs were detected in the fish whole body samples.

Fourteen pesticides were detected in the fish whole body tissue. All the pesticides (aldrin, beta-BHC, gamma-BHC, alpha-chlordane, gamma-chlordane, 4,4'-DDD, 4,4'-DDE, 4,4'-DDT, dieldrin, endosulfan II, endrin, endrin aldehyde, endrin ketone, and heptachlor) are retained as COPCs

Sixteen metals were detected in the fish whole body tissue. Silver is not retained as a COPC because it was not detected in the surface water or sediment. As presented above, calcium, magnesium, potassium, and sodium are not retained as COPCs. The remaining eleven metals (aluminum, barium, cadmium, chromium, copper, iron, lead, manganese, mercury, selenium, and zinc) are retained as COPCs.

Crab Samples

Three crab samples were collected for tissue analysis. All three samples were analyzed for TCL VOCs, SVOCs, and pesticides/PCBs, and TAL metals.

Two VOCs were detected in the crab tissue. Neither VOC (acetone and methylene chloride) is retained as a COPC because they were not detected in the surface water nor sediment. No SVOCs were detected in the fish fillet samples.

Nine pesticides were detected in the crab tissue. All the pesticides (aldrin, beta-BHC, gamma-BHC, alpha-chlordane, 4,4'-DDD, 4,4'-DDE, 4,4'-DDT, dieldrin, and heptachlor) are retained as COPCs

Fourteen metals were detected in the crab tissue. As presented above, calcium, magnesium, potassium, and sodium are not retained as COPCs. The remaining ten metals (aluminum, arsenic, cadmium, cobalt, copper, iron, lead, manganese, selenium, and zinc) are retained as COPCs.

7.3.3 Physical/Chemical Characteristics of COPCs

Physical and chemical characteristics of contaminants may affect their mobility, transport, and bioavailability in the environment. These characteristics include bioconcentration factors (BCFs), organic carbon partition coefficient (K_{oc}), octanol water partition coefficient (K_{ow}), and biotransfer factors (B_v, B_b, B_r). Table 7-8 summarizes these values for the COPCs detected in the surface water, sediment, tissue and surface soil samples. Information from these tables is used to assess the

fate and transport of the constituents and the potential risks to the environmental receptors at each site. The following paragraphs discuss the significance of each parameter included in the table.

Bioconcentration factors measure the tendency for a chemical to partition from the water column or sediment and concentrate in aquatic organisms. Bioconcentration factors are important for ecological receptors because chemicals with high BCFs could accumulate in lower-order species and subsequently accumulate to toxic levels in species higher up the food chain. The BCF is the concentration of the chemical in the organism at equilibrium divided by the concentration of the chemical in the water. Therefore, the BCF is unitless. The BCF used to determine if a contaminant has a high potential to bioaccumulate in aquatic or terrestrial organisms.

The organic carbon partition coefficient (K_{oc}) measures the tendency for a chemical to partition between soil or sediment particles containing organic carbon and water. This coefficient is important in the ecological environment because it determines how strongly an organic chemical will be bound to the organics in the sediments. The K_{oc} is used to calculate sediment quality criteria.

The octanol/water partition coefficient (K_{ow}) is the ratio of a chemical concentration in octanol divided by the concentration in water. The octanol/water partition coefficient has been shown to correlate well with bioconcentration factors in aquatic organisms and with adsorption to soil or sediment. The K_{ow} is used to calculate the plant biotransfer factors that are used to estimate the COPC concentration in plants that would potentially be ingested by the terrestrial receptors in the intake model.

The plant biotransfer factors (B_v or B_r) measure the potential for a chemical to accumulate in a plant. These factors are used to calculate the concentration of the COPCs in either the leafy part of the plant (B_v) or the fruit of the plant (B_r). The factors for inorganics are obtained from Baes et. al., (1984), while the factors for organics are calculated according to Travis and Arms (1988). The B_v and B_r values for the organics are assumed to be same value.

Finally, the beef biotransfer factors (B_b) measure the potential for a chemical to accumulate in an animal. This factor is used to calculate the COPC concentration in the small mammal that is ingested by the red fox. The factors for inorganics are obtained from Baes et. al., (1984), while the factors for organics are calculated according to Travis and Arms (1988).

7.4 Ecosystems Potentially at Risk

Ecological receptors that might be potentially at risk from contaminants at Site 36 were identified during the field investigations and the habitat evaluation. The regional and site-specific ecology are presented in Sections 1.0 and 2.0 of this report. Based on the results of the field investigations and the habitat evaluation, potential receptors of contaminants in surface water and sediment include the following: fish, benthic macroinvertebrates, other aquatic flora and fauna and some terrestrial faunal species. Potential receptors of contaminants in soil include the following: deer, rabbits, foxes, raccoons, birds and other terrestrial flora and fauna.

7.5 Ecological Endpoints

The information compiled during the first stage of problem formulation (stressor characteristics and ecosystems potentially at risk) is used to select the ecological endpoints for this ERA. The following section presents the ecological endpoints selected for this ERA, and the reasons they are selected.

There are two primary types of ecological endpoints: assessment endpoints and measurement endpoints. Assessment endpoints are environmental characteristics, which, if they are found to be significantly affected, may indicate a need for remediation (e.g., decrease in sports/fisheries). Measurement endpoints are quantitative expressions of an observed or measured effect of the contamination of concern. Measurement endpoints may be identical to assessment endpoints (e.g., measurement of abundance of fish), or they may be used as surrogates for assessment endpoints (e.g., toxicity test endpoints). Both types of endpoints are used in the ecological risk evaluation and are presented in the following sections.

A measurement endpoint, or "ecological effects indicator" as it is sometimes referred, is used to evaluate the assessment endpoint. Therefore, measurement endpoints must correspond to, or be predictive of, assessment endpoints. In addition, they must be readily measurable, preferably quickly and inexpensively, using existing techniques. Measurement endpoints must take into consideration the magnitude of the contamination and the exposure pathway. The measurement endpoint should be an indicator of effects that are temporally distributed. Low natural variability in the endpoint is preferred to aid in attributing the variability in the endpoint to the contaminant. Measurement endpoints should be diagnostic of the pollutants of interest, as well as broadly applicable to allow comparison between sites and regions. Also, measurement endpoints should be standardized (e.g., standard procedures for toxicity tests). Finally, it is desirable to use endpoints that already are being measured (if they exist) to determine baseline conditions.

7.5.1 Aquatic Endpoints

The assessment endpoints for the aquatic receptors are changes in the structure of benthic macroinvertebrate communities attributable to site-related contaminants and the potential reduction of an aquatic receptor population or subpopulation that is attributable to site-related contaminants. Measurement endpoints for the first aquatic assessment endpoint include the following: 1) lower benthic macroinvertebrate species diversity and richness when compared to an ecologically similar background location; 2) the dominance of contaminant-tolerant species (opportunistic) over contaminant sensitive species (equilibrium); 3) elevated levels of contaminants in the biota tissue samples as compared to tissue samples collected at off-site background stations or in the literature; and, 4) contaminant levels in the tissue samples that exceed toxicity values in the literature (where available). The measurement endpoints for the second aquatic assessment endpoint include exceedances of contaminant-specific surface water and sediment effect concentrations (i.e., SWSVs, and SSVs).

Species diversity, richness, and change in species dominance are evaluated by comparing the type of species, the species diversity, and community similarity of the benthic macroinvertebrates collected at Site 36 to the appropriate off-site background stations. The dominance of contaminant-tolerant species over contaminant sensitive species is evaluated by comparing the Macroinvertebrate Biotic Index (MBI) of the benthic macroinvertebrates collected at Site 36 to the MBI from the appropriate off-site background stations. The following paragraphs present how the species diversity, community similarity, and MBI are calculated and interpreted.

7.5.1.1 Species Diversity

The benthic macroinvertebrate community was examined using a mathematical expression of community structure called a diversity index. Diversity data are useful because they condense a substantial amount of data into a single value. The Shannon-Wiener diversity index and Brillouin diversity index both were calculated for the benthic macroinvertebrate species.

The Shannon-Wiener (H^1) function is one of the more commonly used formulas for calculating species diversity. Species diversity was calculated in logarithmic base 10 using the following equation (Brower and Zar, 1977):

$$H^1 = \sum (p_i * \log(p_i)).$$

H^1 = mean species diversity

p_i = proportion of the total number of individuals occurring in species i .

Brillouin's diversity (H) is used if a data set is not considered to be a random sample. This situation arises when data comprising an entire population are available or for data that are from a sample obtained non-randomly from a population. Brillouin's diversity is calculated using the following equation (Brower and Zar, 1977):

$$H = \frac{(\log n! - \sum (\log(f_i!)))}{n}$$

H = species diversity

n = the sample size

f = the number of observations in category i

The operative assumption in the interpretation of diversity values is that relatively undisturbed environments tend to support communities that consist of a large number of species with no single species present in overwhelming abundance. Many forms of stress tend to reduce diversity by producing an environment that is less desirable for some taxa and, therefore, giving a competitive advantage to other taxa. In addition, unsuitable habitats in some tidally influenced streams, due to natural salinity fluctuations, will cause the diversity of the benthic macroinvertebrate population to be less than one (Tenore, 1971).

7.5.1.2 Community Similarity

Community similarity between benthic macroinvertebrate stations was measured using two qualitative indices of community similarity, the Jaccard coefficient (S_j) and the Sørensen index (S_s). The indices use two possible attributes of the ecosystem, which is whether a species was or was not present in the collected sample. Because these coefficients are based on the number of species collected and not the number of individuals, a few organisms from several taxa could significantly change the similarity value, whereas there may not be an overall significant difference between the communities.

The S_j is better than the S_s at discriminating between highly similar collections and has been used widely in stream pollution investigations. The S_j ranges from 0.0 (dissimilar) to 1.0 (similar) and is calculated using the following equation (Brower and Zar, 1977):

$$S_j = \frac{a}{a + b + c}$$

a = number of species common to both collections

b = number of species in the first collection but not the second

c = number of species in the second collection but not in the first

The S_s places more emphasis on common attributes, and is better than the S_j at discriminating between highly dissimilar collections. The S_s ranges from 0.0 (dissimilar) to 1.0 (similar) and is calculated using the following equation (Brower and Zar, 1977):

$$S_s = \frac{2a}{2a + b + c}$$

Where a, b, and c are as described above.

These indices are used to detect changes in the community structure. Stressed communities presumably have different species than relatively non-stressed communities, given that all other factors are equal. Several factors determine the type of benthic population that will inhabit an area including salinity fluctuations, sediment type, size of water body, and time of collection. Although the community similarity indices will give some indication as to the similarities of the communities, more weight will be placed on the types of species that were collected, the relative densities, and the species diversities of the site stations as compared to the reference stations.

7.5.1.3 Macroinvertebrate Biotic Index

Most of the benthic macroinvertebrates collected during the ecological investigation have been assigned a pollution tolerance rating. The tolerances were obtained from the NC DEHNR DEM Environmental Sciences Branch (Lenat, 1993) and the USEPA Environmental Monitoring Systems Laboratory (USEPA, 1990). NC DEHNR maintains a complete list of benthic macroinvertebrate species collected, or known to occur, in North Carolina on a database called BINDEK. BINDEK contains the species Latin name, order, biotic index (BI), and feeding group. However, BI have not been developed for many estuarine species. The BI ranges from zero to ten; a zero is assigned to taxa found only in unaltered streams of high water quality, and a ten is assigned to taxa known to occur in streams with intermediate degrees of pollution or disturbance. In addition, USEPA lists many common benthic macroinvertebrate species along with their tolerance to organic wastes, heavy metals, and acids (USEPA, 1990)

The MBI was developed to provide a rapid stream quality assessment. North Carolina had a data set of more than 2,000 stream macroinvertebrate samples that were divided into five water-quality ratings. This data set was used to derive preliminary tolerance values for more than 500 benthic macroinvertebrate taxa. The MBI is intended for the examination of the general level of pollution regardless of the source. The index is an average of the BIs weighed by individual abundance, and is calculated as follows:

$$MBI = \frac{\sum(n_i * BI)}{N}$$

Where:

- MBI = Macroinvertebrate Biotic Index
- n_i = Number of individuals occurring in the i^{th} taxa
- BI = Biotic Index assigned to the i^{th} taxa
- N = Total number of individuals in the sample

The sample benthic macroinvertebrate populations were assigned a general stream/water quality condition based on the MBI value. The five classes and their corresponding MBI values are presented below (Lenat, 1993)

Excellent Water Quality	Good Water Quality	Good-Fair Water Quality	Fair Water Quality	Poor Water Quality
< 5.24	5.25-5.95	5.96-6.67	6.68-7.70	> 7.71

The MBI for the benthic macroinvertebrate stations was calculated using the values listed in BINDEX. When a BI for a specific species was not listed, either the family BI (if available) was used or the species was not included in the species was not included in the MBI calculations.

7.5.2 Terrestrial Endpoints

The assessment endpoint for the terrestrial receptors is the potential reduction of a receptor population or subpopulation that is attributable to contaminants from the site. The measurement endpoints for the terrestrial ERA include: 1) exceedances of contaminant-specific soil effect concentrations (i.e., SSSVs); 2) CDI exceedances of contaminant-specific effect doses (TRVs); and, 3) tissue sample concentration exceedances of proposed criteria for piscivorous wildlife.

7.6 Conceptual Model

This section of the ERA presents each potential exposure pathway via soil, groundwater, surface water, sediment, and air, and the likelihood that an exposure will occur through these pathways. Figure 7-1 presents the flowchart of potential exposure pathways and ecological receptors.

To determine if ecological exposure via these pathways may occur in the absence of remedial actions, an analysis is conducted including the identification and characterization of the exposure pathways. The following four elements are examined to determine if a complete exposure pathway is present:

- A source and mechanism of chemical release
- An environmental transport medium
- A feasible receptor exposure route
- A receptor exposure point

7.6.1 Soil Exposure Pathway

Potential release sources to be considered in evaluating the soil pathway are surface or buried wastes and contaminated soil. The release mechanisms to be considered are fugitive dust, leaching, tracking, and surface runoff. The transport medium is the soil. The potential routes to be considered for ecological exposure to the contaminated soil are ingestion and dermal contact. Potential exposure points for ecological receptors include species living in, or coming in contact with, the soil. COPCs were detected in the surface soil demonstrating a release from a source to the surface soil transport medium. Potential receptors that may be exposed to contaminants in surface soil at/or around surface soil in the areas of detected COPCs include the following: deer, fox, raccoon, rabbits, birds, plants, and other terrestrial life.

Terrestrial receptors potentially are exposed to contaminants in the soil through ingestion, dermal contact, and/or direct uptake (for flora). The magnitude of the exposure depends on their feeding habits and the amount of time they reside in the contaminated soil. In addition, terrestrial species may ingest organisms that have bioconcentrated contaminants from the soil. This exposure pathway is likely to occur at Site 36 and will be retained for further analysis.

7.6.2 Groundwater Exposure Pathway

The potential release source to be considered in evaluating the groundwater pathway is contaminated soil. The release mechanism to be considered is leaching. The routes to be considered for ecological exposure to the contaminated groundwater are ingestion and dermal contact. Groundwater discharge to area surface waters may represent a pathway for contaminant migration.

Sub-surface biota (i.e., microorganisms) are the only ecological receptors expected to be directly exposed to groundwater. Potential impacts to these biota are not assessed in this ERA because current guidance does not provide sufficient information to evaluate risk. In addition, since the receptors of concern are not directly exposed to groundwater at Site 36, the groundwater to surface water exposure is accounted for in the surface water section of the ERA.

7.6.3 Surface Water and Sediment Exposure Pathway

Potential release sources to be considered in evaluating the surface water and sediment pathways are contaminated surface soil and groundwater. The release mechanisms to be considered are groundwater seepage and surface runoff. The potential routes to be considered for ecological exposure to the contaminated surface water/sediment are ingestion and dermal contact. Potential exposure points for ecological receptors include species living in, or coming in contact with, the surface water/sediment on-site or downgradient of the site. COPCs were detected in the surface water and sediment demonstrating a release from a source to the surface water or sediment transport medium. Potential receptors that may be exposed to contaminants in surface water and sediment include the following: fish, benthic macroinvertebrates, deer, birds, and other aquatic and terrestrial life.

Aquatic receptors are exposed to contaminants in the surface water and sediment by ingesting water while feeding and by direct contact while feeding or swimming. This exposure pathway is likely to occur at Site 36 and will be evaluated in the ERA. In addition, aquatic organisms may ingest other aquatic flora and fauna that have bioaccumulated chemicals from the surface water and

sediment. This potential exposure pathway will not be evaluated in the ERA because current guidance does not provide sufficient information to evaluate risk.

Terrestrial faunal receptors potentially are exposed to contaminants in the surface water and sediment through ingestion and dermal contact. The magnitude of the exposure depends on their feeding habits and the amount of time they reside in the contaminated waters. In addition, terrestrial species may ingest organisms (e.g., fish, small mammals, invertebrates, and plants) that have bioconcentrated contaminants from the surface water and sediment. These exposure pathways are likely to occur at Site 36. However, only the surface water and surface soil ingestion pathway will be evaluated in the ERA. Current guidance does not exist to evaluate the sediment pathway, subsurface soil pathway, or dermal contact pathway for terrestrial receptors, therefore, these pathways will not be evaluated in the ERA.

7.6.4 Air Exposure Pathway

There are two potential release mechanisms to be considered in evaluating the atmospheric pathway: release of contaminated particulates and volatilization from surface soil, groundwater and surface water. The potential exposure points for receptors are areas on or adjacent to the site. The air exposure pathway is not evaluated in this ERA because air sampling was not conducted, and current guidance does not provide sufficient information to evaluate risk.

7.7 Exposure Assessment

The next phase after the problem formulation is the exposure assessment that consists of quantifying the potential exposure of the stressors (COPCs) to the ecological receptors.

The RI included collecting samples for analytical analysis from five media; soil, groundwater, surface water, sediment, and tissue (fish, crabs). As presented earlier in the ERA, contaminants in the subsurface soil and groundwater are not evaluated. The analytical results for the data used in ERA are presented in Section 4.0 of this report.

The regional ecology, site ecology, and habitat characterization in the areas surrounding Site 36 are presented in Section 1.0 and 2.0 of this report. Information on sensitive environments and endangered species also is included in this section.

Exposure of contaminants in the surface soil to terrestrial flora and fauna (invertebrates and microorganisms) is assumed to be equal to the contaminant concentration in the surface soil. It is noted in the uncertainty section of this ERA that all the contaminants in the surface soil may not be bioavailable to the terrestrial flora or fauna. Exposure of contaminants in the surface water and sediment to aquatic receptors are assumed to be equal to the contaminant concentration in the surface water and sediment. Exposure of contaminants in the surface soil and surface water to other terrestrial fauna (mammals, birds) is estimated using the chronic daily intake models presented in the next section of this ERA.

The following sections present the results of the ecosystem characterization including the biological sampling, abiotic habitat, and biotic habitat.

7.7.1 Surface Water, Sediment, and Biological Sampling

Biological samples collected at Site 36 included fish and crabs to obtain tissue samples and benthic macroinvertebrates to obtain population statistics. Water quality measurements were collected during the sampling event prior to the surface water and sediment sample collection. These measurements consisted of temperature, pH, specific conductance, salinity, and dissolved oxygen. Site specific descriptions, and field water quality measurements were recorded on field data sheets (see Appendix U). The station locations and sampling procedures for collecting each of the environmental media are presented in Section 2.0 of this report.

7.7.1.1 Abiotic Habitat

The abiotic habitat consists of the description of the stations with regard to size of the creek, depth of the water, substrate type, water chemistry and other such non-biological descriptors. The following sections present the abiotic habitat for the sampling stations at Site 36.

Table 7-9 presents the sampling station characterization summary that includes the stream width and depth, canopy cover, sediment type, and sediment odor of the Site 36 stations and the upstream stations. The stream width ranged from 10 to 75 feet in Brinson Creek, and 2 to 20 feet in the unnamed tributary. The stream depth ranged from 0.5 to 5 feet in Brinson Creek, and 0.3 to 0.5 feet in the unnamed tributary. The canopy cover ranged from shaded to partly open. Finally, the sediment was primarily a sandy-silt with organic material in several samples, with odors including normal, anaerobic and/or petroleum. Oils were observed in several of the sediment samples.

Table 7-10 presents the results of the field chemistry including the temperature, pH, dissolved oxygen concentration, conductivity, and salinity. The temperature ranged from 16.5 to 25.3 °C, the pH ranged from 6.8 to 9.54 S.U., the dissolved oxygen ranged from 2.4 to 18.0 mg/L, the conductivity ranged from 269 to 3,320 umhos/cm, and the salinity ranged from 0 to 1.2 ppt. With the exception of the DO values, the field chemistry at these stations appear to be typical of surface waters at MCB, Camp Lejeune based on previous sampling experience. The high DO values (17.9 to 18.6 ppm) is probably due to a malfunction with the instrument, since it is unlikely the water would have such a high DO due to the low amount of mixing and the high water temperature.

7.7.1.2 Biotic Habitat

The biotic habitat consists of the description of the stations with regard to the biological community. The following sections present the results of the benthic macroinvertebrate community for the sampling stations at Site 36. As presented earlier in this ERA, surface water, sediment, fish, and benthic macroinvertebrate samples also were collected in Brinson Creek, upstream of Site 36. Two of the upstream samples collected in Brinson Creek were collected from non-tidally influenced locations. These samples will not be evaluated in this ERA

With the exception of the fish samples, the upstream samples were used for comparison purposes to determine the spatial trend of impacts. Since fish are migratory, it is not possible to pinpoint exactly the source of their exposure. Therefore, all the fish collected in Brinson Creek, with the exception of the fish collected in the non-tidally influenced location, are assumed to have contact with COPCs related to Site 36.

Fish Community

Fish were collected from three tidal stations in Brinson Creek adjacent to Site 36, and two tidal stations in Brinson Creek upstream of Site 36. The results of the fish sampling effort at these stations are summarized on Table 7-11. The fish distribution and characterization summary is presented in Table 7-12. Appendix Y presents the lengths and weights of the individual fish collected at each station. No external tumors, lesions, or other abnormalities were visually observed on any of the fish collected from Brinson Creek.

Fourteen fish species consisting of 108 individuals were collected at the Site 36 stations, while 17 fish species consisting of 459 individuals were collected at the upstream stations. It should be noted that the majority of the fish collected in the upstream stations were juvenile spot (311 individuals) and striped mullet (55 individuals). These fish were collected via electrofishing. Electrofishing was not used at the Site 36 stations due to the increased salinity and turbidity.

The primary fish collected at the Site 36 stations included the following: striped mullet (20 individuals); white catfish (21 individuals); sheepshead minnow (21 individuals); and, pinfish (10 individuals). Other than the juvenile spot and the striped mullet, the primary fish collected at the upstream stations included the following: mudcatfish (13 individuals); pumpkinseed (14 individuals); longnose gar (10 individuals); sheepshead minnow (12 individuals); and, pinfish (11 individuals). In addition to the fish, 32 blue crabs and 23 grass shrimp were collected from the Site 36 stations.

Benthic Macroinvertebrate Community

Table 7-13 presents the benthic macroinvertebrates collected from the Site 36 stations and the upstream stations. Appendix Z presents the benthic macroinvertebrate raw data tables and laboratory bench sheets for the Site 36 stations and the upstream stations in Brinson Creek. Appendix V presents the benthic macroinvertebrates collected from the off-site reference station (WC02). Table 7-14 presents the tolerance values of each species to organic pollution, and metals, and the North Carolina Biotic Index. Table 7-15 presents all the samples' summary statistics. Finally, Table 7-16 presents the community similarity for the benthic macroinvertebrates between the Site 36 stations, between the Site 36 stations and the upstream stations, and between the Site 36 stations and the off-site reference station.

A total of 17 species consisting of 764 individuals were collected at the three Site 36 stations, while 15 species consisting of 262 individuals were collected at the two upstream stations. At the off-site reference station, 7 species consisting of 79 individuals were collected.

The same two phyla were represented at all the stations (Annelida and Arthropoda). At the Site 36 stations, the majority of the individuals were the annelids Nereis succinea (40.9 to 63.5 percent) and Hypaniola grayi (13.2 to 27.3 percent). In addition, the arthropod Cricotopus ornatus comprised approximately 23 percent of the individuals at 36-BN01. The arthropod Chironomus decorus gr. (42.7 to 89.2 percent) comprised the majority of the individuals collected at the upstream stations and the off-site reference station. The annelid Dero digitata comprised approximately 28 percent of the individuals at 35-BN03 and the annelid Limnodrilus hoffmeisteri comprised approximately 18 percent of the individuals at 35-BN04.

The species diversity at the Site 36 stations, the upstream stations, and the off-site reference station ranged from 0.424 to 0.742, 0.176 to 0.718, and 0.518 to 0.570, respectively. The MBI at the Site 36 stations, the upstream stations, and the off-site reference station ranged from 8.88 to 9.49, 9.44 to 9.48, and 9.4, respectively. The similarities between the Site 36 stations and the off-site reference station ranged from 0.31 to 0.60. The similarities between the Site 36 stations and the upstream stations ranged from 0.06 to 0.45, while the similarities between the Site 36 stations ranged from 0.31 to 0.70.

7.8 Ecological Effects Characterization

The ecological effects data that were used to assess potential risks to aquatic and/or terrestrial receptors in this ERA include aquatic and terrestrial screening values as presented in Section 7.3.4.1 to aid in the selection of the COPCs. The following sections present a summary of the ecological effects comparison.

7.8.1 Surface Water

Contaminant concentrations detected in the surface water at Site 36 were compared to the freshwater or saltwater SWSVs to determine if there were any exceedances of the published values (see Tables 7-1 through 7-4).

7.8.1.1 Freshwater Stations

In summary, barium, copper, iron, manganese and vanadium are the only contaminants (total) detected in the freshwater surface water that exceed any of the SWSVs. Barium, copper, iron, lead, manganese and vanadium are the only contaminants (dissolved), detected in the freshwater surface water that exceed any of the SWSVs.

The SWSVs for barium (69.1 µg/L-acute, 3.8 µg/L-chronic) were the ORNL aquatic benchmarks. These values appear to be overly conservative since the lowest chronic value for aquatic organisms (daphnids) was 5800 µg/L. In addition, it is reported in the Quality Criteria for Water-1986 that soluble barium concentrations in fresh waters generally would have to exceed 50,000 µg/L before toxicity to aquatic life would be expected (USEPA, 1987). Therefore, the maximum barium concentrations in the freshwater surface water samples (39.8 µg/L-total, 19.1 µg/L-dissolved) are below the concentrations that are expected to cause adverse impacts to aquatic life.

The SWSVs for manganese (1,470 µg/L-acute, 80.3 µg/L-chronic) were the ORNL aquatic benchmarks. These values also appear to be overly conservative since the lowest chronic value for aquatic organisms (daphnids) was <1,100 µg/L, while the lowest chronic value for fish was 1,770 µg/L. In addition, it is reported in the Quality Criteria for Water-1986 that the tolerance values for aquatic life in freshwaters range from 1,500 µg/L to 1,000,000 µg/L (USEPA, 1987). Therefore, the maximum manganese concentrations in the freshwater surface water samples (126 µg/L-total, 83.5 µg/L-dissolved), is below the concentrations that are expected to cause adverse impacts to aquatic life.

7.8.1.2 Saltwater Stations

In summary, manganese and nickel are the only contaminants (total) detected in the saltwater surface water that exceed any of the SWSVs. Copper and manganese are the only contaminants (dissolved)

detected in the saltwater surface water that exceed any of the SWSVs. No saltwater SWSVs were available for aluminum, barium, iron or molybdenum.

It is reported in the Quality Criteria for Water-1986 that soluble barium concentrations in saltwaters generally would have to exceed 50,000 µg/L before toxicity to aquatic life would be expected (USEPA, 1987). Therefore, the maximum barium concentration in the saltwater surface water samples (32.6 µg/L-dissolved), is below the concentration that are expected to cause adverse impacts to aquatic life.

The source for the SWSV for manganese of 10 µg/L is not known. However, AQUIRE reports that 10 µg/L caused decreased growth in the pacific oyster (*Crassostrea gigas*). This study, which did not meet the criteria for reliability, may be the data source for the Region III value. Other toxicity values for manganese from AQUIRE listed adverse effects at 20,000 µg/L which is higher than the maximum sample concentration collected at Site 36 (31.9 µg/L-total, 50.9 µg/L-dissolved). These studies also were conducted with mollusk species.

The maximum concentrations of iron (1,380 µg/L-total, 145 µg/L-dissolved) in the surface water are above the concentrations that caused adverse impacts to aquatic life of some of the studies obtained from the Aquatic Information Retrieval Database (AQUIRE) (100 to 330,000 µg/L). However, the majority of the effect concentrations from the studies on AQUIRE are several orders of magnitude above the maximum iron concentration detected in the surface water. Most of the studies on iron in AQUIRE were conducted with various marine phytoplankton cultures.

7.8.2 Sediment

Contaminant concentrations detected in the sediment at Site 36 were compared to SSVs to determine if there were any exceedances of the published values (see Tables 7-5 and 7-6). The samples were separated into freshwater and saltwater samples since the SWSVs are used in the SQC calculation.

7.8.2.1 Freshwater Sediment

Aldrin, 4,4'-DDD, 4,4'-DDE, 4,4'-DDT, dieldrin, endosulfan sulfate, endrin, endrin aldehyde, endrin ketone, and diethylphthalate are the only organics that exceed the SSVs. The organics only exceed either the ER-L, ER-M or the SQC values. The aldrin SSV is the WDNR interim criteria for in-water disposal of dredged sediments (Sullivan, et. al., 1985) and is placed only in the ER-L column. However, this value is based on background conditions, not adverse ecological effects.

Beryllium, cadmium, copper, lead, nickel, and thallium are the only metals that exceed the SSVs. All of these metals exceed the ER-L, however, nickel is the only COPC that exceed the ER-M. The beryllium and thallium SSVs are apparent effect threshold values (Tetra Tech, Inc, 1986), and are placed only in the ER-L column. The cadmium, copper, lead, and nickel SSVs are sediment screening levels (Long et. al., 1995), and have both ER-L and ER-M values.

7.8.2.2 Saltwater Sediment

Alpha-chlordane, 4,4'-DDD, 4,4'-DDE, 4,4'-DDT, dieldrin, endosulfan sulfate, endrin aldehyde, endrin ketone, and diethylphthalate are the only organics that exceed the SSVs. All these organics exceed the ER-L, ER-M, and SQC values in at least one sample with the exception of endrin-aldehyde, which did not exceed the ER-M.

Beryllium, cadmium, lead, mercury, and thallium were the only metals that exceed the SSVs. Beryllium, cadmium, mercury, and thallium only exceed the ER-L value. Lead exceeds both the ER-L and ER-M values.

7.8.3 Fish Tissue

The following sections discuss the chemical concentrations detected in the tissue samples collected from Brinson Creek. The fish tissue samples were divided into two groups for discussion: fillet and whole body. Crab tissue samples were grouped separately from the fish samples. Table 7-17 presents a summary of the fish sent to the laboratory for analysis along with their trophic level.

The individuals in each sample that are retained for chemical analysis are presented in Appendix Y. The appendix lists the length and weight of all the individuals in each composite, along with the new sample number, and how the sample should be prepared for analysis (i.e., fillet, whole body, or edible portion for crabs). In accordance with the Guidance for Assessing Chemical Contaminant Data for use in Fish Advisories, Volume I, Fish Sampling and Analysis (USEPA, 1993d), the smallest fish in a composite should be no less than 75 percent of the total length of the largest individual. As presented in Appendix Y, the minimum to maximum ratio is greater than 75 percent in all but three of the samples. The three samples with ratios less than 75 percent are 36-FS03-BC02 (73 percent), 35-FS02-MC-F01 (71 percent) and 35-FS03-BG-F01 (58 percent). Sample 36-FS03-BC02 was less than 75 percent due to an effort to keep the number of individuals equal to the other crab samples. Sample 35-FS02-MC-F01 was less than 75 percent because it only had two individuals and therefore, the sample grouping could not be selective. Finally, sample 35-FS03-BG-F01 was less than 75 percent because enough individuals had to be used to ensure adequate sample volume for analysis.

Positive detection tables for the tissue samples collected in Brinson Creek are presented in Section 4.0. The statistical summaries for these samples are presented in Appendix I.

The Brinson Creek fish fillet and crab tissue contaminant concentrations were compared to the tissue contaminant concentrations in an off-site tissue study Baker conducted in the White Oak River Basin in 1993 (Baker, 1994a). This background study was limited to the fillet portion of the fish, and the edible portion of crabs (see Appendix V). The Brinson Creek fish whole body tissue contaminant concentrations were compared to the tissue contaminant concentrations in a fish survey conducted in Albermarl and Pamlico Sounds in North Carolina (NC Study) (Benkert, 1992). This background study was limited to the whole body portion of the fish. Table 7-18 presents these comparisons. Contaminant concentrations in the fish also were compared to various proposed criteria values for piscivorous wildlife (see Table 7-19).

7.8.3.1 Fish Tissue Organics

Toluene is the only VOC retained as a COPC in the fish tissue. Toluene was not detected in the off-site background tissue samples, and was not analyzed in the NC Study.

Most of the pesticides detected in the Brinson Creek whole body tissue samples were detected at concentrations either within, or less than one order of magnitude above those detected in the NC Study tissue samples, or they were not analyzed for in the NC Study. All the pesticides detected in Brinson Creek fillet and crab tissue samples were detected at concentrations above those detected in the off-site fillet samples.

Table 7-19 presents a comparison of the maximum fish tissue concentrations to New York State proposed fish tissue criteria for the diet of piscivorous wildlife (Newell *et al.*, 1987). The pesticides 4,4'-DDD, and 4,4'-DDE are the only pesticides that were detected at concentrations above both the proposed non-carcinogenic and 10^{-2} carcinogenic criteria for the diet of piscivorous wildlife. Aldrin and dieldrin were detected at concentrations above the 10^{-2} carcinogenic criteria for the diet of piscivorous wildlife but below the non-carcinogenic criteria. No other pesticides were detected at concentrations above either the proposed non-carcinogenic or 10^{-2} carcinogenic criteria for the diet of piscivorous wildlife.

Data located in the literature to evaluate potential impacts to fish from contaminant concentrations in their tissue was for chlordane. It has been reported that the No Observed Adverse Level (NOAEL) of chlordane in fish tissue is less than 0.1 mg/kg (Arruda *et al.*, 1987). The maximum chlordane concentration of 0.06 mg/kg was below the NOAEL.

7.8.3.2 Fish Tissue Metals

Toxicity data for metals in fish tissue was located for arsenic, cadmium, chromium, mercury and zinc. Therefore, toxicological impacts to aquatic and piscivorous wildlife only are evaluated for these COPCs. However, the comparison of tissue concentrations to other studies is conducted for other metals (aluminum, barium, cobalt, iron, lead, manganese, selenium, and vanadium).

Diminished growth and survival have been reported in immature bluegills (*Lepomis macrochirus*) when total arsenic residues in muscle was greater than 1.3 mg/kg fresh weight, or greater than 5 mg/kg in adults (Eisler, 1988). In addition, depending on the chemical form of arsenic, certain marine teleosts may be unaffected at muscle total arsenic residues of 40 mg/kg (Eisler, 1988). Prescribed limits for arsenic in feedstuff (fishmeals) of domestic livestock are less than 10 mg/kg. Arsenic was not detected in the whole body samples, and was detected at a maximum concentration of 1.8 mg/kg in the white catfish fillet sample. Therefore, arsenic in the whole-body fish tissue samples was less than the 5 mg/kg reported to cause diminished growth and survival in adult fish. The arsenic concentration in the Site 36 fillet tissue concentration was within the range of the off-site background tissue samples. However, the Site 36 crab tissue concentration was greater than the off-site background crab tissue samples.

It is reported that whole body fish tissue concentrations of 2 mg/kg should be viewed as evidence of probable cadmium contamination. In addition, until other data become available, wildlife dietary levels exceeding 0.1 mg/kg diet on a sustained basis should be viewed with caution (Eisler, 1985). The cadmium concentration ranged from 0.25 to 0.88 mg/kg (whole body), 0.33 to 0.5 mg/kg (fillet), and 0.16 to 0.8 mg/kg (crab). Cadmium in the fish whole body samples was only detected in one American eel sample, and one pumpkinseed sample. Cadmium only was detected in the longnose gar in the fillet samples. Since cadmium was not detected in most of the fish samples, it is unlikely that wildlife would have a sustained dietary level of 0.1 mg/kg diet. In addition, the whole body fish tissue samples were less the 2 mg/kg level of probable cadmium contamination, and less than two times greater than the fish in the NC Study.

It has been suggested that organs and tissues of fish and wildlife that contain greater than 4.0 mg/kg total chromium should be viewed as presumptive of chromium contamination (Eisler, 1986). The maximum chromium tissue concentration in the Brinson Creek samples (3.6 mg/kg) is below the concentration considered indicative of contamination. In addition, chromium was detected at a concentration within the range of the detections in the NC Study.

To protect sensitive species of mammals and birds that regularly consume fish and other aquatic organisms, total mercury concentrations in these food items should probably not exceed 0.1 mg/kg for avian protection, and 1.1 mg/kg for small mammals (Eisler, 1987). The maximum mercury tissue concentration in the Brinson Creek samples (1.3 mg/kg) is above these values. However, it only was detected in one sample. The concentration of mercury in the whole body fish tissue samples is within the range of mercury detected in the NC Study, while the concentrations of mercury in the fillet samples are higher than the mercury concentration in the off-site background fish samples. Mercury was not detected in the crab samples.

Bird diets should contain 93 to 120 mg/kg of zinc for adequate to optimal growth, and it should be less than 178 mg/kg to prevent marginal sublethal effects (Eisler, 1993). Dietary loadings that optimally prevent zinc deficiency for the mink is 150 mg/kg (Eisler, 1993). The maximum zinc concentration in the Brinson Creek fish tissue samples (87.1 mg/kg) is below this concentration. The concentrations of zinc in all of the fillet samples are higher than the zinc concentration in the off-site background fish samples. However, the whole body sample concentrations are within one order or magnitude of the NC Study sample concentrations.

Aluminum and arsenic are the only metals detected at lower concentrations in the Brinson Creek fillet samples than the off-site background fish samples. Copper and lead are the only metals (not including those discussed above) that were analyzed in the NC Study. Both of these contaminants were detected at concentrations slightly greater than two times the maximum concentration in the NC Study. For the fillet and crab tissue samples, most of the remaining metals were detected at higher concentrations in the Brinson Creek samples than they were detected in the off-site background samples.

7.8.4 Surface Soil

Although promulgated standards do not exist, Surface Soil Screening Values (SSSVs) that may be used to evaluate potential ecological risks to terrestrial flora and fauna have been developed by USEPA Region III (USEPA, 1995b) and Oak Ridge National Laboratory (ORNL) (Will and Suter, 1994a, 1994b). The contaminant concentrations in the surface soils are compared to the SSSVs to determine if potential impacts to terrestrial flora and fauna invertebrates may be expected (see Table 7-20).

Several of the metals, pesticides, and SVOCs were detected in the surface soil samples at concentrations above the SSSVs. The metals with the highest number of exceedences were aluminum, chromium, and iron with 52 exceedences, vanadium with 50 exceedences, and lead, mercury, and zinc with 15 to 20 exceedences. 4,4'-DDT had the highest number of exceedences for the organics (44), followed by 4,4'-DDE with 14 exceedences. Most of the metal SSSVs were developed by ORNL, while most of the organic SSSVs were developed by USEPA Region III.

7.8.5 Terrestrial Chronic Daily Intake Model

In addition to comparing the soil concentrations to toxicity values for terrestrial invertebrates and plants, a terrestrial Chronic Daily Intake (CDI) model is used to estimate the exposure of the COPCs to terrestrial receptors. The following describes the procedures used to evaluate the potential soil exposure to terrestrial fauna at Site 36 by both direct and indirect exposure to COPCs via surface water, soil, and foodchain transfer.

Based on the regional ecology and potential habitat at the site, the indicator species used in this analysis are the white-tailed deer, cottontail rabbit, red fox, raccoon, and bobwhite quail. The exposure points for these receptors are the surface soil, surface water, and biota. The routes for terrestrial exposure to the COPCs in the soil and water are incidental soil ingestion, drinking water, vegetation (leafy plants, seeds and berries) ingestion, fish ingestion, and ingestion of small mammals.

7.8.5.1 Derivation of Terrestrial Reference Value

Total exposure of the terrestrial receptors to the COPCs in the soil and surface waters is determined by estimating the CDI dose and comparing this dose to Terrestrial Reference Values (TRVs) representing acceptable daily doses in mg/kg/day. The TRVs were developed from No-Observed-Adverse-Effect-Levels (NOAELs) or Lowest-Observed-Adverse-Effect-Levels (LOAELs) obtained from the Integrated Risk Information System (IRIS), Agency for Toxic Substances and Disease Registry Toxicological Profiles, mineral tolerance levels of domestic animals (NAS, 1992) or other toxicological data in the literature. Appendix AA presents the methodology used in deriving the TRVs and the animals that were used to derive each TRV.

7.8.5.2 Calculation of Chronic Daily Intake

Potential impacts of the terrestrial receptors to the COPCs in the soil and surface water are determined by estimating the CDI dose and comparing this dose to TRVs representing acceptable daily doses in mg/kg/day. The CDI equations were adapted from those used in Scarano et. al., (1993). The estimated CDI doses of the bobwhite quail, cottontail rabbit, white-tailed deer and small mammal, to soil, surface water, and vegetation are determined using the following equation:

$$CDI = \frac{(Cw)(Iw) + [(Cs)(Bv)(Iv) + (Cs)(Is)][H]}{BW}$$

Where:

CDI	=	Chronic Daily Intake, mg/kg/d
Cw	=	Contaminant concentration in the surface water, mg/L
Iw	=	Rate of drinking water ingestion, L/d
Cs	=	Contaminant concentration in soil, mg/kg
Bv	=	Soil to plant transfer coefficient (leaves, stems, straw, etc.), unitless
Iv	=	Rate of vegetation ingestion, kg/d
Is	=	Incidental soil ingestion, kg/d
H	=	Contaminated area/Home area range area ratio, unitless
BW	=	Body weight, kg

To calculate the contaminant concentration in the small mammal, the resulting CDI from the above equation is multiplied by the biotransfer factor for beef (Bb) for organics (Travis and Arms, 1988) and metals (Baes, et.al., 1984).

The estimated CDI dose of the raccoon is determined using the following equation.

$$CDI = \frac{(C_w)(I_w) + (C_f)(I_f) + [(C_s)(Br)(I_v) + (C_s)(I_s)][H]}{BW}$$

Where:

CDI	=	Chronic Daily Intake, mg/kg/d
C _w	=	Contaminant concentration in the surface water, mg/L
I _w	=	Rate of drinking water ingestion, L/d
C _f	=	Contaminant concentration in the fish, mg/kg
I _f	=	Rate of fish ingestion, kg/d
C _s	=	Contaminant concentration in soil, mg/kg
Br	=	Soil to plant transfer coefficient (fruit, seeds, tubers, etc.), unitless
I _v	=	Rate of vegetation ingestion, kg/d
I _s	=	Incidental soil ingestion, kg/d
H	=	Contaminated area/Home area range area ratio, unitless
BW	=	Body weight, kg

The contaminant concentration in the fish is the whole body fish concentration from the samples collected in Brinson Creek.

The estimated CDI dose of the red fox is determined using the following equation:

$$CDI = \frac{(C_w)(I_w) + [(C_s)(B_v)(I_v) + (C_s)(I_s) + (C_m)(I_m)][H]}{BW}$$

Where:

CDI	=	Chronic Daily Intake, mg/kg/d
C _w	=	Contaminant concentration in the surface water, mg/L
I _w	=	Rate of drinking water ingestion, L/d
C _s	=	Contaminant concentration in soil, mg/kg
B _v	=	Soil to plant transfer coefficient (leaves, stems, straw, etc.), unitless
I _v	=	Rate of vegetation ingestion, kg/d
I _s	=	Incidental soil ingestion, kg/d
C _m	=	Contaminant concentrations in small mammals, mg/kg
I _m	=	Rate of small mammal ingestion, kg/d
H	=	Contaminated area/Home area range area ratio, unitless
BW	=	Body weight, kg

Bioconcentration of the COPCs to plants is calculated using the soil to plant transfer coefficient (B_v or Br) for organics (Travis and Arms, 1988) and metals (Baes *et al.*, 1984). The concentrations of the COPCs used in the models were the lower of the upper 95 percent confidence limit or the maximum concentration detected of each COPC. The exposure parameters used in the CDI calculations are presented in Table 7-21.

7.9 Risk Characterization

The risk characterization is the final phase of a risk assessment. It is at this phase that the likelihood of adverse effects occurring as a result of exposure to a stressor is evaluated. This section evaluates the potential decrease in aquatic and terrestrial populations at Site 36 from contaminants identified at the site.

A Quotient Index (QI) approach is used to characterize the risk to aquatic receptors from exposure to surface water and sediments and terrestrial receptors from exposure to surface soil, surface water, and biota. This approach characterizes the potential effects by comparing exposure levels of COPCs in the surface water and sediments to the aquatic reference values presented in Section 7.8, Ecological Effects Characterization. The QI is calculated as follows:

$$QI = \frac{(EC, CDI)}{(SWSV, SSV, TRV)}$$

Where: Quotient Index
EC = Exposure Concentration, µg/L, µg/kg or mg/kg
CDI = Chronic Daily Intake, mg/kg/day
SWSV = Surface Water Screening Value, µg/L
SSV = Sediment Screening Value, µg/kg or mg/kg
TRV = Terrestrial Reference Value, mg/kg/day

A QI greater than "unity" is considered to be indicative of potential risk. Such values do not necessarily indicate that an effect will occur but only that a lower threshold has been exceeded. However, it is important to determine which contaminants are posing the highest risks, in order to evaluate the significance of those contaminants to the site. Therefore, the evaluation of the significance of the QI has been judged as follows: (Menzie *et al.*, 1993)

- QI exceeds "1" but less than "10": some small potential for environmental effects
- QI exceeds "10": significant potential that greater exposures could result in effects based on experimental evidence
- QI exceeds "100": effects may be expected since this represents an exposure level at which effects have been observed in other species

The risks characterized above provide insight into general effects upon animals and plants in the local population. However, depending on the endpoint selected, they may not indicate if population-level effects will occur.

7.9.1 Surface Water

Tables 7-22 and 7-23 present the surface water QIs for the freshwater and saltwater stations, respectively. A hardness of 74 mg/L CaCO₃ was used to calculate the hardness-dependent SWSVs for the total metals (copper and nickel) in Section 7.3.2, since this was the lowest hardness detected at any of the stations. The actual hardness at the freshwater stations ranged from 74 to 130 mg/L CaCO₃. Appendix X presents the hardness and surface water QI calculations. Figure 7-2

graphically displays the QIs that exceed "1". The following sections present the potential risks to aquatic life from contaminants detected in the surface water.

7.9.1.1 Freshwater Stations

Copper was the only hardness dependent contaminant that exceeds a SWSV after adjusting the hardness for the specific sample. However, copper only was detected in the upstream station (36-SW01) and is not considered site-related. In summary, barium, iron, and manganese were the only site-related total freshwater surface water COPCs that had QIs greater than "1". With the exception of one barium sample (QI = 10.5) and one vanadium sample (QI=20.3), the remaining QIs were less than "10", and most were less than "5".

A hardness of 26 mg/L CaCO₃ was used to calculate the hardness-dependent SWSVs for the dissolved metals (copper, lead, nickel, and zinc) in Section 7.3.2, since this was the lowest hardness detected at any of the stations. The hardness at the freshwater stations ranged from 26 to 103 mg/L CaCO₃. Copper and lead were the only hardness dependent contaminants that exceed a SWSV after adjusting the hardness for the specific sample. In addition, the only copper QI that exceeds "1" was from the sample collected at the upstream station (36-SW01). In summary, barium, iron, and lead were the only site-related dissolved freshwater surface water COPCs that had QIs greater than "1". With the exception of one lead sample (QI = 17.2) and vanadium in one sample (QI=12.7), the remaining QIs were less than "8". It should be noted that the lead sample with the highest QI was located at the upstream station (36-SW01) and is not considered site-related.

As presented in the Ecological Effects section of this ERA, the SWSVs for barium and manganese appear to be extremely conservative, based on other literature sources. Therefore, the concentrations of these contaminants are not expected to decrease the population of aquatic receptors. Based on the relatively low QIs for iron and lead, there is a slight potential for these contaminants to decrease the population of aquatic receptors.

7.9.1.2 Saltwater Stations

Manganese and nickel are the only total saltwater surface water COPCs that have QIs greater than "1", while copper and manganese are the only dissolved saltwater surface water COPCs that have QIs greater than "1". Based on the relatively low QIs for copper and nickel (1.7 to 2.8), and the fact that they only exceed the SWSV in one sample each, a significant decrease in the population of aquatic receptors from site-related COPCs in the surface water is not expected.

7.9.2 **Sediment**

Tables 7-24 and 7-25 present the sediment QIs for the freshwater and saltwater stations, respectively. Figure 7-2 graphically displays the QIs that exceed "1". Appendix X presents the SQC and the sediment QI calculations. TOC values of 2,600 mg/kg (freshwater) and 2,100 mg/kg (saltwater) are used to calculate the SQC values since these are the lowest TOCs detected in the respective samples. The actual TOC values at the site range from 2,600 to 50,000 mg/kg (freshwater) and 2,100 to 176,000 mg/kg (saltwater). The QIs are calculated using the sample-specific TOC values. The following sections present the potential risks to aquatic life from contaminants detected in the sediment.

7.9.2.1 Freshwater Stations

The pesticides 4,4'-DDD, 4,4'-DDE, 4,4'-DDT, dieldrin, endrin, endrin aldehyde, endrin ketone, and diethylphthalate are the only organics detected in the sediment samples with QIs that exceed "1". Dieldrin only was detected in the upstream sample (36-SD01), and is not considered site-related. The ER-M QIs for endrin, endrin aldehyde, and endrin ketone, and the SQC QIs were less than "2". The ER-L QIs for 4,4'-DDD, 4,4'-DDE, 4,4'-DDT all exceed "10", while only the ER-M QIs for 4,4'-DDD exceed "10". 4,4'-DDD, 4,4'-DDT and diethylphthalate were the only organics with SQC QIs that exceed "10". Based on the relatively high ER-M and SQC QIs, there is a moderate potential for 4,4'-DDD, 4,4'-DDT and diethylphthalate, and a slight potential for the remaining pesticides to cause a decrease in the aquatic receptor population.

Beryllium, cadmium, copper, lead, nickel, and thallium are the only metals detected in the sediment samples with QIs that exceed "1". All the ER-L QIs were less than "8". Nickel, in one sample, was the only metal COPC with an ER-M QI that exceeds "1". Beryllium and thallium both were detected at higher concentrations in the upstream sample (36-SD01), which is considered upgradient of the Site 36. Therefore, these contaminants are not considered site-related. Based on the relatively low QIs, there is only a very slight potential for the site-related metals detected in the sediment to cause a decrease in the aquatic receptor population.

7.9.2.2 Saltwater Stations

Alpha-chlordane, 4,4'-DDD, 4,4'-DDE, 4,4'-DDT, dieldrin, endrin aldehyde, endrin ketone and diethylphthalate are the only organics detected in the sediment samples with QIs that exceed "1". The QI for endosulfan sulfate did not exceed "1" after adjusting the SQC for station-specific total organic carbon. Several of the ER-L QIs were greater than ten, and a few were greater than 100. Based on the relatively high ER-M and SQC QIs, there is a moderate potential for pesticides and diethylphthalate detected in the sediment to cause a decrease in the aquatic receptor population.

Beryllium, cadmium, lead, mercury, and thallium are the only metals detected in the sediment samples with QIs that exceed "1". The QIs for beryllium, cadmium, mercury, and thallium were all less than "5". The QI for lead in one sample was 323 (ER-L) and 69.3 (ER-M). The QIs for lead in another sample was 2.5 (ER-L) and less than one for the ER-M. With the exception of the one lead sample, there is only a very slight potential for the site-related metals detected in the sediment to cause a decrease in the aquatic receptor population.

7.9.3 **Terrestrial Chronic Daily Intake Model**

Table 7-26 presents the QI for the terrestrial CDI model. Appendix AA contains the CDI spreadsheets. The red fox, bobwhite quail, and white-tail deer have QIs of 1.33, 3.64, and 1.78, respectively. The QIs for the cottontail rabbit and raccoon are 19.0 and 22.9, respectively. None of the individual contaminant QIs for the red fox or whitetail deer exceed "1", while aluminum (QI=1.27) is the only individual QI for the bobwhite quail that exceeds "1". Aluminum, cadmium, iron, silver, vanadium, and zinc account for the majority of the cottontail rabbit QI, while aluminum, cadmium, selenium, and silver, account for the majority of the raccoon QI. All the individual contaminant QIs are less than "11".

7.10 Ecological Significance

This section essentially summarizes the overall risks to the ecology at the site. It addresses impacts to the ecological integrity at Site 36 from the COPCs detected in the media, and determines which COPCs are impacting the site to the greatest degree, and what site-related contaminants are "significant". This information, to be used in conjunction with the human health risk assessment, supports the selection of remedial action(s) for Site 36 that are protective of public health and the environment.

7.10.1 Aquatic Receptors

7.10.1.1 Freshwater Stations

Based on the risk characterization, there is a slight potential for metals in the surface water and sediment, and a moderate potential for pesticides (4,4'-DDD and 4,4'-DDT) and diethylphthalate in the sediment, to decrease in the population of aquatic life at the freshwater stations. As presented in Section 4.0, diethylphthalate may have migrated from the site.

In general, the highest pesticide concentrations in the sediment were detected in the furthest downstream station (36-SD03). Pesticides reportedly have not been stored or disposed at Site 36 so the most likely source of the pesticides is the wide-spread application of pesticides that was conducted at MCB, Camp Lejeune.

Although fish collections were not conducted at the freshwater stations, many small fish (most likely mosquito fish) were observed during the sampling events at Stations 36-SW/SD02 and 36-SW/SD03. Due to the small size and shallow water of the tributary at these stations, this type of fish population was expected. Therefore, the contaminants in the surface water and sediment do not appear to be eliminating the population of fish in the tributary.

7.10.1.2 Saltwater Stations

Based on the risk characterization, there is a very slight potential for metals in the surface water (copper, nickel), and a moderate potential for metals (lead), pesticides (4,4'-DDD, and 4,4'-DDE) and diethylphthalate in the sediment, to decrease the population of aquatic life at the saltwater stations. As presented in Section 4.0, diethylphthalate may have migrated from the site.

In general, the highest pesticide concentrations in the sediment were detected in the furthest downstream station (36-SD05). The maximum pesticide concentrations in the Site 36 samples (1,140 µg/kg for 4,4'-DDD and 1,200 µg/kg for 4,4'-DDE) are several orders of magnitude higher than the maximum pesticide concentrations in the upstream Brinson Creek samples (111 µg/kg for 4,4'-DDD and 115 µg/kg for 4,4'-DDE). As presented above, the highest pesticide contamination in the tributary sediment also was detected at the furthest downstream sample. Station 36-SD05 is located immediately downstream of the tributary so the pesticides at 36-SD05 may be due to runoff from the tributary. Pesticides reportedly have not been stored or disposed at Site 36. Therefore, the probable source of the pesticides in the sediment is the wide-spread application of pesticides that was conducted at MCB, Camp Lejeune.

Aldrin, dieldrin, 4,4'-DDD, and 4,4'-DDE were the only pesticides detected in the whole body fish tissue samples at concentrations above the proposed piscivorous wildlife criteria. Some of these

pesticides may have been accumulated from the pesticides detected in the sediment at Site 36. None of the pesticides caused a risk in the raccoon from ingesting the fish.

The high lead concentration (15,100 mg/kg) in the sediment was detected at the sample collected adjacent to the site (36-SD06). The source of the high lead concentration is not known. The maximum lead concentration in the surface soil is 836 mg/kg so it is unlikely that surface soil runoff is the source of the lead in the sediment. Since the sample was collected near a former wharf, which is a very accessible location, it is possible that the lead is due to sinkers associated with recreational fishing activities, or activities related to the former wharf. In addition, two sediment samples were collected adjacent to the 36-SD06 in October 1995. The concentrations of lead in these samples were 15.9 and 21.9 mg/kg, both of which are below the SSVs. Therefore, it appears that the high lead concentration in 36-SD06 may have been an anomaly and does not appear to be indicative of actual site concentrations. Lead in the fish and crabs were slightly elevated versus the background samples. However, it did not cause a risk to the raccoon ingesting the fish.

Cadmium was only metal detected in the whole-body tissue samples above the wildlife dietary levels that posed a risk to the raccoon. However, cadmium only was detected at low concentrations in two surface water samples (both below the SWSVs), and was not detected in the sediment. Therefore, it is likely that the cadmium in the tissue samples is not site-related.

Several of the contaminants detected in the fish and crab tissues appeared to be slightly elevated. However, based on the relatively abundant and diverse fish population in Brinson Creek, these contaminants do not appear to be significantly impacting the fish community in terms of population. However, it should be noted that the fish may be impacted in other ways that are not readily visibly (i.e., internal pathologies, decreased reproduction, decreased growth, etc.).

Overall, there were more benthic macroinvertebrate species and individuals, and higher species diversity at the three Site 36 stations, compared to the upstream Brinson Creek stations and the off-site reference station. The MBI was high at all the stations, indicating that a large percentage of species were pollution-tolerant.

A study conducted in the Pamlico River Estuary, North Carolina, indicated that the Shannon-Weiner species diversity in the oligohaline zone was 0.69, and the species density was 375/m² (Tenore, 1971). In addition, the oligohaline zone is dominated by Rangia cuneata and Nereis succinea (Tenore, 1971). The species diversity at the Site 36 stations were similar to the 0.69 diversity (0.43, 0.62 and 0.74), while the species density was higher at two Site 36 stations (280/m², 2,218/m², and 2,371/m²). In addition, the three Site 36 stations were dominated by Nereis succinea (40.9%, 63.5%, and 49.5%). Therefore, it appears that the benthic macroinvertebrate community at Site 36 is representative of the benthic macroinvertebrate community that is expected based on the habitat, salinity, and regional comparisons.

7.10.2 Terrestrial Receptors

Several contaminants were detected in the surface soil at concentrations that exceed the SSSVs. Therefore, there is the potential for a decrease in the population of terrestrial plants and invertebrates in these areas. However, no visible signs of stressed or dead vegetation in these areas were observed during the field investigations.

All the QI values for the terrestrial CDI model are greater than "1". The QIs for the red fox, bobwhite quail, and whitetail deer ranged from 1.33 to 3.64, which indicates a very slight potential for adverse risk to these species. The QIs for the cottontail rabbit and the raccoon are 19.0 and 22.9, respectively. The individual QIs for the six metals that comprised the majority of the rabbit QI ranged from 1.22 to 3.5, while the individual QIs for the four metals that comprised the majority of the raccoon QI ranged from 1.5 to 10.0. Therefore, although there is a slight to moderate potential for adverse impacts to rabbits and raccoons from contaminants at Site 36, the risks are not due to one specific contaminant.

7.10.3 Threatened and Endangered Species

The American alligator is the only threatened or endangered species known to occur at Site 36. Due to elevated levels of some of the COPCs in the surface water and sediment, there is the potential for the alligator to be impacted by these contaminants. However, no toxicological data was located in the literature to quantitatively evaluate risk to the alligator.

7.10.4 Wetlands

Some wetlands have been identified at Site 36. Several contaminants in the surface soil, some of which were in topography low areas that may be wetlands, did exceed plant SSSVs. In addition, samples were collected in the surface water and sediment in the water bodies adjacent to the wetlands and some COPCs exceeded SWSVs and SSVs. Therefore, potential impacts to aquatic and terrestrial receptors associated with these wetlands are evaluated in other sections of this ERA.

7.11 Uncertainty Analysis

The procedures used in this evaluation to assess risks to ecological receptors, as in all such assessments, are subject to uncertainties. The following discusses some of the uncertainty in this ERA.

The chemical sampling program at Site 36 consisted of seven surface water samples and twelve saltwater sediment samples. Because there were less than twenty samples, contaminants could not be eliminated because of infrequency. Therefore, contaminants not related to the site may have been retained as COPCs and thus carried through the ERA.

There is uncertainty in the ecological endpoint comparison. The SWSVs (WQS and AWQC) are established to be protective of a majority of the potential receptors. However, some species will not be protected by the values because of their increased sensitivity to the chemicals. In addition, most of the values are established using laboratory tests, where the concentrations of certain water quality parameters (pH, hardness, total organic carbon) that may influence toxicity are most likely at different concentrations in the site water.

Potential adverse impacts to aquatic receptors from contaminants in the sediments were evaluated by comparing the COPC concentration in the sediments to SSVs. These SSVs have more uncertainty associated with them than do the SWSVs, since the procedures for developing them are not as established as those used in developing SWSVs. In addition, sediment type (pH, acid volatile sulfide, total organic carbon) also has a significant impact on the bioavailability and toxicity of contaminants.

There is uncertainty in comparing tissue concentrations to fish collected in Brinson Creek to fish collected in other studies. In many cases, the fish that were collected in Brinson Creek were different species than the fish collected in the other studies. Many contaminants bioaccumulate differently in different species. Therefore, comparisons of contaminant concentrations of different fish may be misleading. Finally, there is limited data in the literature to assess potential impacts to fish from contaminants in their tissue.

Potential adverse impacts to terrestrial invertebrates and plants were evaluated by comparing the COPC concentration in the soil to SSSVs. Most of these studies do not account for the soil type, which may have a large influence on the toxicity of the contaminants. For example, soil with high organic carbon content will tend to sorb many of the organic COPCs, thus making them less bioavailable to terrestrial receptors. In addition, most of the SSSVs are based on one or two studies, which greatly adds to their uncertainty.

There are some differences of opinion found in the literature as to the effectiveness of using models to predict concentrations of contaminants found in terrestrial species. According to one source, the food chain models currently used incorporate simplistic assumptions that may not represent actual site conditions, bioavailability of contaminants, or site-specific behavior of the receptors. Simple food chain models can provide an effective means of initial characterization of risk, however, residue analyses, toxicity tests, and the use of biomarkers provide a better approach for assessing exposure (Menzie *et.al.*, 1993).

There are several sources of uncertainty when using these models. First, most of the terrestrial reference values are based on toxicity data from another species, which is then extrapolated to the species of concern using a body-size scaling equation. Since the toxicity of all contaminants may not be proportional to body size, the calculated TRVs may not accurately predict risk to the species of concern. Another source of uncertainty with the models is that many of the input parameters are based on default values (i.e., ingestion rate) that may or may not adequately represent the actual values of the parameters. In addition, there is uncertainty in the amount that the indicator species will represent other species potentially exposed to COPCs at the site. There is uncertainty in use of the bioconcentration and biotransfer factors. Bioconcentration and biotransfer factors can vary widely from species to species. The species used in the calculation of the bioconcentration and biotransfer factors are different than the species that actually occur at the site. Therefore, use of the factors will tend to either overestimate or underestimate actual bioaccumulation of contaminants. Finally, terrestrial receptors also may be exposed to contaminants in the sediments. However, currently, there is no guidance in the literature that can be used to evaluate this potential exposure pathway.

The toxicity of chemical mixtures is not well understood. All the toxicity information used in the ERA for evaluating risk to the ecological receptors is for individual chemicals. Chemical mixtures can affect the organisms very differently than the individual chemicals due to synergistic or antagonistic effects. In addition, the species that were used to develop the toxicity data may not be present at the site, or have the potential to exist at the site. Depending on the sensitivity of the tested species to the species at the site use of the toxicity values may overestimate or underestimate risk. Many chemicals are not acutely toxic, however, they have the potential to bioaccumulate in ecological receptors through food chain transfer. This bioaccumulation potential typically is not taken into account when comparing contaminant concentrations to screening values.

Finally, toxicological data for several of the COPCs were limited or do not exist. Therefore, there is uncertainty in any conclusions involving the potential impacts to aquatic receptors from these contaminants

7.12 Conclusions

7.12.1 Aquatic Ecosystem

As presented earlier in the ERA, the assessment endpoints for the aquatic receptors are changes in the structure of benthic macroinvertebrate communities attributable to site-related contaminants and the potential reduction of an aquatic receptor population or subpopulation that is attributable to site-related contaminants. These assessment endpoints were evaluated using a series of measurement endpoints. This section of the ERA examines each of the measurement endpoints to determine if the assessment endpoints are impacted.

The first measurement endpoint is lower benthic macroinvertebrate species diversity and richness in the Site 36 stations when compared to an ecologically similar background location. Overall, there were more benthic macroinvertebrate species and individuals, and higher species diversity at the three Site 36 stations, compared to the upstream Brinson Creek stations and the off-site reference station. The MBI was high at all the stations, indicating that a large percentage of species were pollution-tolerant. In addition, the species diversity and density at the Site 36 stations were similar to or higher than the study conducted in the Pamlico River Estuary, North Carolina. Therefore, it appears that the benthic macroinvertebrate community at Site 36 is representative of the benthic macroinvertebrate community that is expected based on the habitat, salinity, and regional comparisons.

The second measurement endpoint is determining if the Site 36 benthic macroinvertebrates are dominated by contaminant-tolerant species as opposed to contaminant-sensitive species. The MBI was high at all the stations (including the upstream stations), indicating that a large percentage of species were pollution-tolerant. However, in the Pamlico River Estuary study, the comparable stations (base on salinity) were dominated by Rangia cuneata and Nereis succinea (Tenore, 1971). The three Site 36 stations were dominated by Nereis succinea (40.9%, 63.5%, and 49.5%).

The third measurement endpoint is determining if the contaminant levels in the Site 36 biota tissue samples is elevated when compared to tissue samples collected at off-site background stations or in the literature. Several of the contaminants detected in the fish and crab tissues appeared to be slightly elevated. However, based on the relatively abundant and diverse fish population in Brinson Creek, these contaminants do not appear to be significantly impacting the fish community.

The fourth measurement endpoint is determining if the contaminant levels in the Site 36 fish tissue samples exceed toxicity values in the literature. Chlordane and arsenic was the only contaminant detected in the fish tissue samples for which toxicity data was located in the literature. Chlordane and arsenic were detected at a concentration in the fish tissue below the reported toxicity concentration. In addition, it should be noted that the concentration of cadmium and chromium were detected at concentrations below those reported as indicative of contamination.

The last measurement endpoint is determining if the contaminant concentrations in the surface water and sediment exceed the contaminant-specific surface water and sediment effect concentrations (i.e., SWSVs, and SSVs).

There is a slight potential for metals in the surface water and sediment, and a moderate potential for pesticides (4,4'-DDD and 4,4'-DDT) and diethylphthalate in the sediment, to decrease in the population of aquatic life at the freshwater stations. There is a very slight potential for metals in the surface water (copper, nickel), and a moderate potential for metals (lead), pesticides (4,4'-DDD, and 4,4'-DDE) and diethylphthalate in the sediment, to decrease the population of aquatic life at the saltwater stations. Pesticides reportedly have not been stored or disposed at Site 36. Therefore, the probable source of the pesticides in the sediment is the wide-spread application of pesticides that was conducted at MCB, Camp Lejeune.

The high lead concentration in the sediment was detected at the sample collected adjacently to the site (36-SD06). The source of the high lead concentration is not known. However, based on additional sediment sampling, it appears that the high lead concentration in 36-SD06 may have been an anomaly, and does not appear to be indicative of actual site concentrations.

Overall, the contaminants in the surface water and sediment have a slight potential to reduce the aquatic receptor population in the freshwater stations. There is a very slight potential for metals in the surface water (copper, nickel), and a moderate potential for metals (lead), pesticides (4,4'-DDD, and 4,4'-DDE) and diethylphthalate in the sediment, to decrease the population of aquatic life at the saltwater stations. The benthic macroinvertebrates do not appear to be impacted based on the results of the sampling events. Some of the contaminants in the fish tissue are elevated. However, due to the lack of toxicological data, the potential risk to the fish from those contaminants cannot be evaluated.

7.12.2 Terrestrial Ecosystem

As presented earlier in the ERA, the assessment endpoints for the terrestrial receptors is the potential reduction of a receptor population or subpopulation that is attributable to contaminants from the site. This section evaluates this assessment endpoint using the measurement endpoints.

The first measurement endpoint is determining if there is an exceedance of contaminant-specific soil effect concentrations (i.e., SSSVs). Several contaminants were detected at concentrations in the surface soil that exceed the SSSVs.

The second measurement endpoint is determining if the terrestrial CDI exceeds the TRVs. The CDI exceeds the TRV for the all five terrestrial species. However, the risk is higher for the cottontail rabbit and raccoon. The risks to these species are due to a few contaminants with relatively low QIs, not one specific contaminant driving the risk.

Finally, the last measurement endpoint is determining if the tissue sample concentrations exceed proposed criteria for piscivorous wildlife. Aldrin, dieldrin, 4,4'-DDD, and 4,4'-DDE are the only pesticides detected in the whole body fish tissue samples at concentrations above the proposed piscivorous wildlife criteria. Some of these pesticides may have accumulated from the pesticides detected in the sediment at Site 36. None of the pesticides caused a risk in the raccoon from ingesting the fish. Lead in the fish and crabs were slightly elevated versus the background samples. However, it did not cause a risk to the raccoon ingesting the fish. Cadmium was only metal detected in the whole-body tissue samples above the wildlife dietary levels that posed a risk to the raccoon. However, the cadmium in the tissue samples does not appear to be site-related.

Overall, some potential impacts to soil invertebrates and plants may occur as a result of site-related contaminants. It should be noted that there is much uncertainty in the SSSVs. There is a slight potential for decrease in the terrestrial vertebrate population from site-related contaminants based on the terrestrial intake model.

7.13 References

Arruda, J.A., M.S. Cringan, D. Gilliland, G. Haslouer, J.E. Fry, R. Broxterman, and K.L. Brunson. 1987. Correspondence Between Urban Areas and the Concentrations of Chlordane in Fish from the Kansas River. *Bull. environ. Contam. Toxicol.* 39:563-570. Cited in Eisler, 1990.

Arthur and Alldredge. 1979. Public Health Evaluation and Ecological Assessment. Martin Marrietta Astronautics Group, Waterton Facility, Vol. II of III, Appendix A and B. Cited in Scarano, 1993.

Agency for Toxic Substances and Disease Registry (ASTDR). 1993. Toxicological Profile for Endosulfan. Prepared by Clement Associates for the US Department of Health and Human Services.

Baes, C.F., Sharp, A.L., and R.W. Shor. September 1984. "Review and Analysis of Parameters for Assessing Transport of Environmentally Released Radionuclides through Agriculture." Oak Ridge National Laboratory.

Baker, 1994a. Supplemental Aquatic Survey for Wallace Creek and Bearhead Creek Operable Unit No. 2 (Sites 6,9, and 82). Prepared by Baker Environmental Inc., for the Department of the Navy, Atlantic Division, Naval Facilities Engineering Command. September, 1994.

Benkert, Kathryn, A. 1992. Contaminant Assessment of Biota and Sediments in the Albemarle-Pamlico Region. U.S. Fish and Wildlife Service, Fish and Wildlife Enhancement, Raleigh Field Office, Raleigh, North Carolina. January 1992.

Beyer, N., E. Connor, and S. Gerould. 1993. "Estimates of Soil Ingestion by Wildlife". Patuxent Wildlife Research Center, Laurel, MD.

Boschung, Herbert T., James D. Williams, Danial W. Gotshall, Melba C. Caldwell, and David K. Caldwell. 1983. *The Audubon Society Field Guide to North American Fishes, Whales, and Dolphins*. Alfred A. Knopf, Inf. New York.

Brower, James E, and Jerrold H. Zar. 1977. Field and Laboratory Methods for General Ecology. Wm. C. Brown Company Publishers.

Dee, J.C. November, 1991. "Methodology For Assessing Potential Risks To Deer Populations: A Case Study at a Superfund Site". Paper presented at the 1991 Annual Meeting of the Society of Environmental Toxicology and Chemistry. Abstract No. 426.

Eisler, Ronald. 1993. Zinc Hazards to Fish, Wildlife, and Invertebrates: A Synoptic Review. U.S. Fish and Wildlife Service, Patuxent Wildlife Research Center, Laurel, MD. Biological Report 10. April, 1993.

- Eisler, Ronald. 1990. Chlordane Hazards to Fish, Wildlife, and Invertebrates: A Synoptic Review. U.S. Fish and Wildlife Service, Patuxent Wildlife Research Center, Laurel, MD. Biological Report 85(1.21). July, 1990.
- Eisler, Ronald. 1988. Arsenic Hazards to Fish, Wildlife, and Invertebrates: A Synoptic Review. U.S. Fish and Wildlife Service, Patuxent Wildlife Research Center, Laurel, MD. Biological Report 85(1.12). January, 1988.
- Eisler, Ronald. 1987. Mercury Hazards to Fish, Wildlife, and Invertebrates: A Synoptic Review. U.S. Fish and Wildlife Service, Patuxent Wildlife Research Center, Laurel, MD. Biological Report 85(1.10). April 1987.
- Eisler, Ronald. 1986. Chromium Hazards to Fish, Wildlife, and Invertebrates: A Synoptic Review. U.S. Fish and Wildlife Service, Patuxent Wildlife Research Center, Laurel, MD. Biological Report 85(1.6). January, 1986.
- Eisler, Ronald. 1985. Cadmium Hazards to Fish, Wildlife, and Invertebrates: A Synoptic Review. U.S. Fish and Wildlife Service, Patuxent Wildlife Research Center, Laurel, MD. Biological Report 85(1.2). July, 1985.
- Fitchko, J. 1989. Criteria for Contaminated Soil/Sediment Cleanup. Pudvan Publishing Company, Northbrook, Illinois.
- Kennish, Micheal J. Ph.D. 1986. Ecology of Estuaries. Volume II Biological Aspects. CRC Press, Boca Raton, Florida.
- Lenat, David R. 1993. "A Biotic Index for the Southeast United States: Derivation and List of Tolerance Values, with Criteria for Assigning Water-Quality Ratings". Includes February 1994 Table Update. *J. N. Am. Benthol. Sci.*, 1993, 12(3):279-290.
- Long, E.W., D.D. Macdonald, S.L. Smith, and F.D. Calder. 1995. "Incidence of Adverse Biological Effects within Ranges of Chemical Concentrations in Marine and Estuarine Sediments." *Environmental Management* Vol. 19, No.1, pp. 81-97.
- Long, E.R and Morgan, L.G. 1991. The Potential for Biological Effects of Sediment-Sorbed Contaminants Tested in the National Status and Trends Program. National Oceanic and Atmospheric Administration Technical Memorandum NOS OMA 52.
- Menhinick, Edward F. 1992. The Freshwater Fishes of North Carolina. North Carolina Wildlife Resources Commission. Raleigh, North Carolina.
- Menzie, C.A., Cura J. and J. Freshman. January 1993. Evaluating Ecological Risks and Developing Remedial Objectives at Forested Wetland Systems in New England. Paper contained in: Application of Ecological Risk Assessment To Hazardous Waste Site Remediation. Water Environmental Federation.
- Montgomery, J.H. and L.M. Welton. 1990. Groundwater Chemicals Desk Reference. Lewis Publishers, Inc. Chelsea, Michigan.

Nagy, Kenneth. 1987. "Field Metabolic Rate and Food Requirement Scaling in Mammals and Birds. Ecological Monographs." 57(2). pp. 111-128.

NAS. 1992. Subcommittee on Mineral Toxicity in Animals. Mineral Tolerance of Domestic Animals. National Academy of Sciences. Washington, D.C. pp 5-7.

NC DEHNR. 1994. 15A NCAC 2b.0200 - Classifications and Water Quality Standards Applicable to Surface Waters of North Carolina. State of North Carolina Department of Health and Natural Resources. June 1, 1994.

NC DEHNR. 1993. Classifications and Water Quality Standards Assigned to the Waters of the White Oak River Basin. State of North Carolina Department of Health and Natural Resources. February 1, 1993.

Newell, Arthur J., David W. Johnson, and Laurie K. Allen. 1987. Niagara River Biota Contamination Project: Fish Flesh Criteria for Piscivorous Wildlife. Division of Fish and Wildlife, Bureau of Environmental Protection. Technical Report 87-3. July 1987.

Opresko, D.M., B.E. Sample, and G.W. Suter II. 1994. Toxicological Benchmarks for Wildlife, 1994 Revisions. Prepared for the US Department of Energy, Office of Environmental Restoration and Waste Management. September, 1994. ES/ER/TM-86/R1.

Raasch, Maynard S. and Vaughn L. Altemus, Sr. 1991. Deleware's Freshwater and Brackish Water Fishes: A Popular Account. Deleware State Collee center for the Sutdy of Del-Mar-Va Habitats and Society of Natural History of Deleware, Dover, Deleware.

Rhode, Fred C., Rudolf G. Arndt, David G. Lindquist, and James F. Parnell. 1994. Freshwater Fishes of the Carolinas, Virginia, Maryland, and Deleware. Univ. of North Carolina Press.

SCDM. 1991. Superfund Chemical Data Matrix. United States Environmental Protection Agency Hazardous Site Evaluation Division. December 1991.

Scarano, Louis, J. Ph.D. and Daniel M. Woltering, Ph.D. January 1993. "Terrestrial and Aquatic Eco-Assessment for A RCRA Hazardous Waste Site". Paper contained in: Application of Ecological Risk Assessment To Hazardous Waste Site Remediation. Cited in WEF, 1993.

Sullivan, J., J. Ball, E. Brick, S. Hausmann, G., G. Pilarski, and D. Sopcich. 1985 Report of the Technical Subcommittee on Determination of Dredge Material Suitability for In-Water Disposal. Wisconsin Department of Natural Resources, Madison, WI. November, 1985.

Suter, G.W. II. and J.B. Mabrey. 1994. Toxicological Benchmarks for Screening Potential Contaminants of Concern for Effects on Aquatic Biota:1994 Revision. Environmental Sciences Division, Oak Ridge National Laboratory.

Tenore, Kenneth R. 1971. "Macrobenthos of the Pamlico River Estuary, North Carolina". Department of Zoology, North Carolina State University, Raleigh North Carolina.

Tetra Tech, Inc. 1986. Development of Sediment Quality Values for Puget Sound, Volume I. Puget Sound Dredged Disposal Analysis Report. Cited in Fitchko, 1989.

Travis, Curtis C. and Angela Arms. 1988. Bioconcentration of Organics in Beef, Milk, and Vegetation. Environmental Science Technology. Vol. 22, No. 3.

USEPA, US Environmental Protection Agency. January 26, 1995a. "Toxic Substance Spreadsheet". Region IV, Atlanta, Georgia.

USEPA, US Environmental Protection Agency. January 19, 1995b. "Region III BTAG Screening Levels". Region III, Philadelphia, PA.

USEPA, US Environmental Protection Agency. September 26, 1994. Ecological Risk Assessment Guidance for Superfund: Process for Designing and Conducting Ecological Risk Assessments. Environmental Response Team, Edison, NJ.

USEPA, US Environmental Protection Agency. March 1993a. Fish Field and Laboratory Methods for Evaluating the Biological Integrity of Surface Waters. Office of Research and Development. EPA/600/R-92/111.

USEPA, US Environmental Protection Agency. September 1993b. Technical Basis for Deriving Sediment Quality Criteria for Nonionic Organic Contaminants for the Protection of Benthic Organisms by using Equilibrium Partitioning. Office of Water. EPA-822-R-93-011.

USEPA, US Environmental Protection Agency. 1993c. "Water Quality Guidance for the Great Lakes System and Correction: Proposed Rules". Federal Register. 58(72) 20802-21047. Cited in Suter and Mabrey, 1994.

USEPA, US Environmental Protection Agency. September 1993d. Guidance for Assessing Chemical Contaminant Data for Use in Fish Advisories. Volume I. Fish Sampling and Analysis. Office of Water. EPA-823-R-93-002.

USEPA, US Environmental Protection Agency. September 1993e. Sediment Quality Criteria for the Protection of Benthic Organisms- Fluoranthene. Office of Science and Technology. Health and Ecological Criteria Section. Washington, D.C. EPA-822-R-93-012.

USEPA, US Environmental Protection Agency. September 1993f. Sediment Quality Criteria for the Protection of Benthic Organisms- Phenanthrene. Office of Science and Technology. Health and Ecological Criteria Section. Washington, D.C. EPA-822-R-93-014.

USEPA, US Environmental Protection Agency. September 1993g. Sediment Quality Criteria for the Protection of Benthic Organisms- Dieldrin. Office of Science and Technology. Health and Ecological Criteria Section. Washington, D.C. EPA-822-R-93-015.

USEPA, US Environmental Protection Agency. September 1993h. Sediment Quality Criteria for the Protection of Benthic Organisms- Endrin. Office of Science and Technology. Health and Ecological Criteria Section. Washington, D.C. EPA-822-R-93-016.

USEPA, US Environmental Protection Agency. December 1993i. Wildlife Exposure Factors Handbook. United States Environmental Protection Agency. Office of Research and Development. Washington, D.C. EPA/600/R-93/187a.

SECTION 7.0 TABLES

TABLE 7-1

**FREQUENCY AND RANGE OF CONTAMINANT DETECTIONS
 COMPARED TO FRESHWATER SURFACE WATER SCREENING VALUES
 SITE 36, CAMP GEIGER AREA DUMP
 REMEDIAL INVESTIGATION, CTO-0303
 MCB, CAMP LEJEUNE, NORTH CAROLINA**

Contaminant	Surface Water Screening Values (SWSV)			Average Reference Station Concentration	Contaminant Frequency/Range		No. of Positive Detects Above Lowest SWSV	No. of Positive Detects Above the Average Reference Station Concentration
	North Carolina Water Quality Standards (WQS) ⁽¹⁾	USEPA Region IV Water Quality Screening Values (WQSV) ⁽²⁾			No. of Positive Detects/No. of Samples	Range of Positive Detections		
		Acute	Chronic					
Volatiles (µg/L) 1,2-Dichloroethene (total)	NE	11,600 ^(a)	1240	ND	1/3	7	0	1
Inorganics (µg/L) Aluminum	NE	750	87	333	1/3	2.4	0	0
Antimony	NE	NE	30 ^(a)	ND	2/3	2J-2.8	0	2
Barium	NE	69.1 ^(a)	3.8 ^(a)	25.67	3/3	12.1-39.8	3	2
Calcium	NE	NE	NE	17,567	3/3	19,500-44,400	NA	3
Copper	7	13.4 ^(a)	9.1 ^(a)	ND	1/3	56.5	1	1
Iron	1,000	NE	1,000	576	3/3	2,320J-4,840J	3	3
Magnesium	NE	NE	NE	1,745	2/3	1,550-7,850	NA	1
Manganese	NE	1,470 ^(a)	80.3 ^(a)	ND	3/3	58.4-126	2	3
Molybdenum	NA	10,100 ^(a)	239 ^(a)	ND	1/3	50J	0	1
Nickel	88	1,099 ^(a)	122 ^(a)	ND	3/3	16.4-31.4	0	3
Potassium	NE	NE	NE	ND	3/3	5,310-18,800	NA	3
Sodium	NE	NE	NE	9,830	3/3	99,500-330,000	NA	3
Vanadium	NE	284 ^(a)	19.1 ^(a)	ND	3/3	79-387	3	3

TABLE 7-1 (Continued)

**FREQUENCY AND RANGE OF CONTAMINANT DETECTIONS
COMPARED TO FRESHWATER SURFACE WATER SCREENING VALUES
SITE 36, CAMP GEIGER AREA DUMP
REMEDIAL INVESTIGATION, CTO-0303
MCB, CAMP LEJEUNE, NORTH CAROLINA**

Notes:

NE = Not Established

NA = Not Applicable

(1) NC DEHNR, 1994 (Water Quality Standards)

(2) USEPA, 1995a (Region IV Toxic Substance Spreadsheet)

(3) Criteria are hardness dependent; values are based on a hardness of 74 mg/L as CaCO₃

(4) USEPA, 1995b (Region III BTAG Screening Levels)

(5) Suter and Mabrey, 1994 (Toxicological Benchmarks for Screening Potential COCs for Effects on Aquatic Biota)

TABLE 7-2

FREQUENCY AND RANGE OF DISSOLVED CONTAMINANT DETECTIONS
 COMPARED TO FRESHWATER SURFACE WATER SCREENING VALUES
 SITE 36, CAMP GEIGER AREA DUMP
 REMEDIAL INVESTIGATION CTO-0303
 MCB, CAMP LEJEUNE, NORTH CAROLINA

Contaminant	Surface Water Screening Values (SWSV)			Contaminant Frequency/Range		No. of Positive Detects Above Lowest SWSV
	North Carolina Water Quality Standards (WQS) ⁽¹⁾	USEPA Region IV Water Quality Screening Values (WQSV) ⁽²⁾		No. of Positive Detects/No. of Samples	Range of Positive Detects	
		Acute	Chronic			
Inorganics (µg/L)						
Aluminum	NE	750	87	1/3	37.9	0
Barium	NE	69.1 ⁽³⁾	3.8 ⁽³⁾	3/3	5.3-19.1	3
Calcium	NE	NE	NE	3/3	9470-40,300	NA
Cobalt	NE	NE	NE	1/3	4.1	NA
Copper	7	5.0 ⁽³⁾	3.8 ⁽³⁾	3/3	3.4-19	2
Iron	1,000	NE	1,000	3/3	1,240-1,630	3
Lead	25	15.0 ⁽³⁾	0.59 ⁽³⁾	3/3	9.1J-15.6J	3
Magnesium	NE	NE	NE	3/3	688-1,910	NA
Manganese	NE	1,470 ⁽³⁾	80.3 ⁽³⁾	3/3	28.6-83.5	1
Nickel	88	461 ⁽³⁾	51 ⁽³⁾	3/3	20.4-29.9	0
Potassium	NE	NE	NE	3/3	4,090J-6,080J	NA
Sodium	NE	NE	NE	3/3	73,400-159,000	NA
Vanadium	NE	284 ⁽³⁾	19.1 ⁽³⁾	3/3	81-243	3
Zinc	50	38 ⁽³⁾	34 ⁽³⁾	3/3	14.1-32.8	0

Notes:

NE = Not Established

NA = Not Applicable

⁽¹⁾ NC DEHNR, 1994 (Water Quality Standards)

⁽²⁾ USEPA, 1995a (Region IV Toxic Substance Spreadsheet)

⁽³⁾ Criteria are hardness dependent; values are based on a hardness of 26 mg/L as CaCO₃

⁽⁴⁾ USEPA, 1995b (Region III BTAG Screening Levels)

⁽⁵⁾ Suter and Mabrey, 1994 (Toxicological Benchmarks for Screening Potential COCs for Effects on Aquatic Biota)

TABLE 7-3

FREQUENCY AND RANGE OF CONTAMINANT DETECTIONS
 COMPARED TO SALTWATER SURFACE WATER SCREENING VALUES
 SITE 36, CAMP GEIGER AREA DUMP
 REMEDIAL INVESTIGATION, CTO-0303
 MCB, CAMP LEJEUNE, NORTH CAROLINA

Contaminant	Surface Water Screening Values (SWSV)			Average Reference Station Concentration	Contaminant Frequency/Range		No. of Positive Detects Above Lowest SWSV	No. of Positive Detects Above the Average Reference Station Concentration
	North Carolina Water Quality Standards (WQS) ⁽¹⁾	USEPA Region IV Water Quality Screening Values (WQSV) ⁽²⁾			No. of Positive Detects/No. of Samples	Range of Positive Detection		
		Acute	Chronic					
Inorganics (µg/L)								
Aluminum	NE	NE	NE	333	3/4	1-1.3	NA	0
Antimony	NE	NE	500 ⁽³⁾	ND	3/4	1.9J-3.9	0	3
Calcium	NE	NE	NE	17,567	4/4	33,700-48,800	NA	4
Iron	NE	NE	NE	576	4/4	967J-1,380J	NA	4
Magnesium	NE	NE	NE	1,745	4/4	6,420-17,900	NA	4
Manganese	NE	NE	10 ⁽³⁾	ND	3/4	24.5-31.9	3	3
Molybdenum	NE	NE	NE	ND	4/4	35J-65J	NA	4
Nickel	8.3	75	8.3	ND	1/4	23.2	1	1
Potassium	NE	NE	NE	ND	4/4	5,920-8,210	NA	4
Sodium	NE	NE	NE	9,830	4/4	95,500-192,000	NA	4
Thallium	NE	NE	20 ⁽³⁾	ND	1/4	1.1J	0	1
Vanadium	NE	NE	10,000 ⁽³⁾	ND	4/4	4.5-85	0	4

Notes:

NE = Not Established
 NA = Not Applicable
 ND = Not Detected

⁽¹⁾ NC DEHNR, 1994 (North Carolina Water Quality Standards)
⁽²⁾ USEPA, 1995a (Region IV Toxic Substance Spreadsheet)
⁽³⁾ USEPA, 1995b (Region III BTAG Screening Levels)

TABLE 7-4

FREQUENCY AND RANGE OF DISSOLVED CONTAMINANT DETECTIONS
 COMPARED TO SALTWATER SURFACE WATER SCREENING VALUES
 SITE 36, CAMP GEIGER AREA DUMP
 REMEDIAL INVESTIGATION CTO-0303
 MCB, CAMP LEJEUNE, NORTH CAROLINA

Contaminant	Surface Water Screening Values (SWSV)			Contaminant Frequency/Range		No. of Positive Detects Above Lowest SWSV
	North Carolina Water Quality Standards (WQS) ⁽¹⁾	USEPA Region IV Water Quality Screening Values (WQSV) ⁽²⁾		No. of Positive Detects/No. of Samples	Range of Positive Detection	
		Acute	Chronic			
Inorganics (µg/L)						
Aluminum	NE	NE	NE	1/4	62	NA
Barium	NE	NE	NE	4/4	22.4-32.6	NA
Cadmium	5	43	9.3	2/4	2.2-2.7	0
Calcium	NE	NE	NE	4/4	86,400-110,000	NA
Copper	3	2.9	2.9	2/4	2.6-4.8	1
Iron	NE	NE	NE	1/4	145	NA
Lead	25	220	8.5	1/4	0.8J	0
Magnesium	NE	NE	NE	4/4	187,000-271,000	NA
Manganese	NE	NE	10 ⁽³⁾	4/4	23.8-50.9	4
Potassium	NE	NE	NE	4/4	64,900J-95,900J	NA
Sodium	NE	NE	NE	4/4	1,570,000-2,190,000	NA
Vanadium	NE	NE	<10,000 ⁽³⁾	2/4	5.6-41.5	0
Zinc	86	95	86	1/4	8.5	0

Notes:

NE = Not Established
 NA = Not Applicable
 ND = Not Detected

⁽¹⁾ NC DEHNR, 1994 (North Carolina Water Quality Standards)
⁽²⁾ USEPA, 1995a (Region IV Toxic Substance Spreadsheet)
⁽³⁾ USEPA, 1995b (Region III BTAG Screening Levels)

TABLE 7-5

**FREQUENCY AND RANGE OF CONTAMINANT DETECTIONS
 COMPARED TO FRESHWATER SEDIMENT SCREENING VALUES
 SITE 36, CAMP GEIGER AREA DUMP
 REMEDIAL INVESTIGATION, CTO-0303
 MCB, CAMP LEJEUNE, NORTH CAROLINA**

Contaminant	Sediment Screening Values (SSV)			Average Reference Station Concentration	Contaminant Frequency/Range		No. of Positive Detects Above Lowest SSV	No. of Positive Detect Above the Average Reference Concentration
	ER-L	ER-M	SQC ⁽³⁾		No. of Positive Detects/No. of Samples	Range of Positive Detects		
Semivolatiles (µg/kg)								
Bis(2-ethylhexyl)phthalate	5,300 ⁽⁴⁾	NE	7,800	ND	2/5	242J-328J	0	2
Diethylphthalate	5,300 ⁽⁴⁾	NE	1.11	ND	2/5	330J-896	2	2
Pyrene	665 ⁽¹⁾	2,600 ⁽¹⁾	NE	ND	1/5	316J	0	1
Pesticides (µg/kg)								
Aldrin	10 ⁽⁶⁾	NE	0.50	1.05	1/5	0.93J	1	0
4,4'-DDD	2 ⁽²⁾	20 ⁽²⁾	2.00	1.57	5/5	14P-1,030	5	5
4,4'-DDE	2.2 ⁽¹⁾	27 ⁽¹⁾	11.44	2.42	2/5	66J-169	2	2
4,4'-DDT	1 ⁽²⁾	7 ⁽²⁾	0.63	2.20	4/5	7.4J-18J	4	4
Dieldrin	0.02 ⁽²⁾	8 ⁽²⁾	0.92	1.96	1/5	0.8J	1	0
Endosulfan sulfate	NE	NE	0.41 ⁽⁷⁾	ND	1/5	3J	1	1
Endrin	0.02 ⁽²⁾	45 ⁽²⁾	0.36	ND	1/5	6.6J	1	1
Endrin aldehyde	0.02 ⁽⁸⁾	45 ⁽⁸⁾	0.36 ⁽⁸⁾	2.01	1/5	3.5J	1	1
Endrin ketone	0.02 ⁽⁸⁾	45 ⁽⁸⁾	0.36 ⁽⁸⁾	ND	1/5	11J	1	1
Inorganics (mg/kg)								
Aluminum	NE	NE	NE	1,166	5/5	3,720-26,300	NA	5
Arsenic	8.2 ⁽¹⁾	70 ⁽¹⁾	NE	0.37	4/4	0.99J-2.1J	0	4
Barium	500 ⁽⁶⁾	NE	NE	6.46	5/5	11-79.1	0	5
Beryllium	0.5 ⁽⁵⁾	NE	NE	0.09	2/5	0.81-1.3	2	2
Cadmium	1.2 ⁽¹⁾	9.6 ⁽¹⁾	NE	0.04	1/5	8.7	1	1

TABLE 7-5 (Continued)

FREQUENCY AND RANGE OF CONTAMINANT DETECTIONS
 COMPARED TO FRESHWATER SEDIMENT SCREENING VALUES
 SITE 36, CAMP GEIGER AREA DUMP
 REMEDIAL INVESTIGATION, CTO-0303
 MCB, CAMP LEJEUNE, NORTH CAROLINA

Contaminant	Sediment Screening Values (SSV)			Average Reference Station Concentration	Contaminant Frequency/Range		No. of Positive Detects Above Lowest SSV	No. of Positive Detect Above the Average Reference Concentration
	ER-L	ER-M	SQC ⁽³⁾		No. of Positive Detects/No. of Samples	Range of Positive Detects		
Calcium	NE	NE	NE	1,967	5/5	1,150J-13,600J	NA	4
Chromium	81 ⁽¹⁾	370 ⁽¹⁾	NE	1.86	5/5	7.3-23.3	0	5
Cobalt	NE	NE	NE	ND	1/5	6.3	NA	1
Copper	34 ⁽¹⁾	270 ⁽¹⁾	NE	0.75	5/5	3.2-45.1	1	5
Iron	27,000 ⁽⁵⁾	NE	NE	434	5/5	3,140-8,530	0	5
Lead	46.7 ⁽¹⁾	218 ⁽¹⁾	NE	0.79	5/5	17.9J-148	2	5
Magnesium	NE	NE	NE	45.25	5/5	151-1,240	NA	5
Manganese	230 ⁽⁵⁾	NE	NE	3.63	5/5	4.7-47.5	0	5
Nickel	20.9 ⁽¹⁾	51.6 ⁽¹⁾	NE	ND	4/5	3.1-77.1	2	4
Potassium	NE	NE	NE	ND	2/5	839-1,010	NA	2
Sodium	NE	NE	NE	ND	3/5	487-1,130	NA	3
Thallium	0.24 ⁽⁵⁾	NE	NE	0.10	4/5	0.19-0.42	2	4
Vanadium	NE	NE	NE	1.52	5/5	10.8-314	NA	5
Zinc	150 ⁽¹⁾	410 ⁽¹⁾	NE	5.11	1/1	140	0	1

TABLE 7-5 (Continued)

FREQUENCY AND RANGE OF CONTAMINANT DETECTIONS
COMPARED TO FRESHWATER SEDIMENT SCREENING VALUES
SITE 36, CAMP GEIGER AREA DUMP
REMEDIAL INVESTIGATION, CTO-0303
MCB, CAMP LEJEUNE, NORTH CAROLINA

Notes:

NE = Not Established

NA = Not Applicable

ER-L = Effects Range Low

ER-M = Effects Range Median

SQC = Sediment Quality Criteria

(1) Long *et al.*, 1995

(2) Long and Morgan, 1991

(3) Values were calculated using the following equation: $SQC = Foc * Koc * FCV / 1000000$

Where:

Foc = Fraction of organic carbon in the sediments (used 2,600 mg/kg)

Koc = Organic carbon partition coefficient (chemical specific)

FCV = Final water chronic value (chemical specific)

(4) USEPA, 1995a (Region III BTAG Screening Levels)

(5) Tetra Tech Inc., 1986 (Apparent Effects Threshold Sediment Quality Values)

(6) Sullivan *et al.*, 1985

(7) Used Endosulfan Value

(8) Used Endrin Value

TABLE 7-6

**FREQUENCY AND RANGE OF CONTAMINANT DETECTIONS
 COMPARED TO SALTWATER SEDIMENT SCREENING VALUES
 SITE 36, CAMP GEIGER AREA DUMP
 REMEDIAL INVESTIGATION, CTO-0303
 MCB, CAMP LEJEUNE, NORTH CAROLINA**

Contaminant	Sediment Screening Values (SSV)			Average Reference Station Concentration	Contaminant Frequency/Range		No. of Positive Detects Above Lowest SSV	No. of Positive Detect Above the Average Reference Concentration
	ER-L	ER-M	SQC ⁽³⁾		Range of Positive Detects	No. of Positive Detects/No. of Samples		
Volatiles (µg/kg) Tetrachloroethene	NE	NE	344	ND	1/8	4J	0	1
Semivolatiles (µg/kg) Anthracene	85.3 ⁽¹⁾	1,100 ⁽¹⁾	NE	ND	1/8	46J	0	1
Diethylphthalate	5,300 ⁽⁴⁾	NE	1.26	ND	1/8	2,135J	1	1
Di-n-butylphthalate	5,300 ⁽⁴⁾	NE	1,213	ND	1/8	218J	0	1
Pesticides (µg/kg) 4,4'-DDD	2 ⁽²⁾	20 ⁽²⁾	1.62	1.57	7/8	41-1,140	7	7
4,4'-DDE	2.2 ⁽¹⁾	27 ⁽¹⁾	9.24	2.42	7/8	32J-1,200	7	7
4,4'-DDT	1 ⁽²⁾	7 ⁽²⁾	0.51	2.2	7/8	3J-46J	7	7
Alpha-chlordane	0.5 ⁽²⁾	6 ⁽²⁾	1.18	1.2	2/8	6.5J-13J	2	2
Dieldrin	0.02 ⁽²⁾	8 ⁽²⁾	0.75	1.96	2/8	14J-52	2	2
Endrin aldehyde	0.02 ⁽⁷⁾	45 ⁽⁷⁾	0.29 ⁽⁷⁾	2.01	1/8	7.6J	1	1
Inorganics (mg/kg) Aluminum	NE	NE	NE	1,166	10/10	1,560-31,500	NA	10
Arsenic	8.2 ⁽¹⁾	70 ⁽¹⁾	NE	0.37	9/9	0.67J-3.3L	0	9
Barium	500 ⁽⁶⁾	NE	NE	6.46	10/10	2.4-60.9	0	5
Beryllium	0.5 ⁽⁵⁾	NE	NE	0.09	2/10	0.16-1.1	1	2
Cadmium	1.2 ⁽¹⁾	9.6 ⁽¹⁾	NE	0.04	1/10	1.4	1	1
Calcium	NE	NE	NE	1,967	9/10	301J-17,500J	NA	5
Chromium	81 ⁽¹⁾	370 ⁽¹⁾	NE	1.86	9/10	2.4-28.6	0	9
Cobalt	NE	NE	NE	ND	2/8	1.1-1.4	NA	2
Copper	34 ⁽¹⁾	270 ⁽¹⁾	NE	0.75	10/10	3.4-24.4	0	10

TABLE 7-7

CONTAMINANTS OF POTENTIAL CONCERN IN EACH MEDIA
 SITE 36, CAMP GEIGER AREA DUMP
 REMEDIAL INVESTIGATION, CTO-0303
 MCB, CAMP LEJEUNE, NORTH CAROLINA

Contaminant	Freshwater Stations			Saltwater Stations			Surface Soil	Fish Samples		Crab Samples
	Surface Water		Sediment	Surface Water		Sediment		Fillet	Whole Body	
	Aquatic receptors	Terrestrial receptor		Aquatic receptors	Terrestrial receptor					
Volatiles										
1,2-Dichloroethene		X								
Toluene							X	X	X	
Semivolatiles										
Benzo(b)fluoranthene							X			
Bis(2-ethylhexyl)phthalate							X			
Butylbenzylphthalate							X			
Diethylphthalate			X			X				
Fluoranthene							X			
Indeno(1,2,3-cd)pyrene							X			
Phenanthrene							X			
Pyrene							X			
Pesticides/PCBs										
Aldrin							X	X	X	X
Beta-BHC								X	X	X
Gamma-BHC								X	X	X
Alpha-chlordane						X	X	X	X	X
Gamma-chlordane							X		X	
4,4'-DDE			X			X	X	X	X	X
4,4'-DDD			X			X	X	X	X	X
4,4'-DDT			X			X	X	X	X	X
Dieldrin						X	X	X	X	X

TABLE 7-7 (Continued)

CONTAMINANTS OF POTENTIAL CONCERN IN EACH MEDIA
 SITE 36, CAMP GEIGER AREA DUMP
 REMEDIAL INVESTIGATION, CTO-0303
 MCB, CAMP LEJEUNE, NORTH CAROLINA

Contaminant	Freshwater Stations			Saltwater Stations			Surface Soil	Fish Samples		Crab Samples
	Surface Water		Sediment	Surface Water		Sediment		Fillet	Whole Body	
	Aquatic receptors	Terrestrial receptor		Aquatic receptors	Terrestrial receptor					
Pesticides/PCBs (Cont.)										
Endosulfan I							X			
Endosulfan II								X	X	
Endosulfan sulfate			X							
Endrin			X					X	X	
Endrin aldehyde			X			X		X	X	
Endrin ketone			X					X	X	
Heptachlor								X	X	X
Heptachlor epoxide							X	X		
Aroclor-1248							X			
Aroclor-1254							X			
Inorganics										
Aluminum			X	X		X	X	X	X	X
Antimony		X			X		X			
Arsenic							X	X		X
Barium	X	X		X			X	X	X	
Beryllium			X			X				
Cadmium			X		X	X	X	X	X	X
Chromium							X	X	X	
Cobalt	X		X			X	X			X
Copper	X	X	X	X			X	X	X	X
Iron	X	X		X	X		X	X	X	X

TABLE 7-7 (Continued)

CONTAMINANTS OF POTENTIAL CONCERN IN EACH MEDIA
 SITE 36, CAMP GEIGER AREA DUMP
 REMEDIAL INVESTIGATION, CTO-0303
 MCB, CAMP LEJEUNE, NORTH CAROLINA

Contaminant	Freshwater Stations			Saltwater Stations			Surface Soil	Fish Samples		Crab Samples
	Surface Water		Sediment	Surface Water		Sediment		Fillet	Whole Body	
	Aquatic receptors	Terrestrial receptor		Aquatic receptors	Terrestrial receptor					
Inorganics (Cont.)										
Lead	X		X			X	X		X	X
Manganese	X	X		X	X		X	X	X	X
Mercury						X	X	X	X	
Molybdenum		X		X	X					
Nickel		X	X	X	X		X			
Selenium							X	X	X	X
Silver							X			
Thallium			X		X	X				
Vanadium	X	X	X		X	X	X	X		
Zinc							X	X	X	X

TABLE 7-8

**PHYSICAL/CHEMICAL CHARACTERISTICS OF THE COPCS
SITE 36, CAMP GEIGER AREA DUMP
REMEDIAL INVESTIGATION, CTO-0303
MCB, CAMP LEJEUNE, NORTH CAROLINA**

Contaminant of Potential Concern	BCF	Organic Carbon Partition Coefficient (mL/g)	Log Octanol/Water Coefficient	Biotransfer Factors		
				Bv ⁽¹⁾⁽²⁾	Br ⁽¹⁾⁽²⁾	Bb ⁽¹⁾⁽²⁾
Volatiles						
1,2-Dichloroethene	5.6 ⁽³⁾	54 ⁽⁵⁾	2 ⁽⁶⁾	2.70e+00	2.70e+00	2.51e-06
Toluene	10.70 ⁽³⁾	300 ⁽⁵⁾	2.70 ⁽⁶⁾	1.07e+00	1.07e+00	1.26e-05
Semivolatiles						
Benzo(b)fluoranthene	30 ⁽³⁾	550,000 ⁽⁵⁾	6.6 ⁽⁶⁾	6.00e-03	6.00e-03	1.00e-01
Bis(2-ethylhexyl)phthalate	130 ⁽³⁾	100,000 ⁽⁷⁾	5.1 ⁽⁶⁾	4.40e-02	4.40e-02	3.16e-03
Butylbenzylphthalate	414 ⁽³⁾	ND	4.9 ⁽⁶⁾	5.70e-02	5.70e-02	2.00e-03
Diethylphthalate	73 ⁽³⁾	142 ⁽⁵⁾	3.2 ⁽⁶⁾	5.48e-01	5.48e-01	3.98e-05
Fluoranthene	1,150 ⁽³⁾	100,000 ⁽⁸⁾	5.1 ⁽⁸⁾	4.40e-02	4.40e-02	3.90e-03
Indeno(1,2,3-cd)pyrene	30 ⁽³⁾	1,600,000 ⁽⁵⁾	6.5 ⁽⁵⁾	7.00e-03	7.00e-03	8.13e-02
Phenanthrene	30 ⁽³⁾	28,840 ⁽⁹⁾	4.5 ⁽⁹⁾	9.70e-02	9.70e-02	7.94e-04
Pyrene	30 ⁽³⁾	38,000 ⁽⁵⁾	5.3 ⁽⁶⁾	3.30e-02	3.30e-02	5.01e-03
Pesticides/PCBs						
Aldrin	4,670 ⁽³⁾	96,000 ⁽⁵⁾	3 ⁽⁶⁾	7.14e-01	7.14e-01	2.51e-05
Beta-BHC	130 ⁽³⁾	3,800 ⁽⁵⁾	3.8 ⁽⁶⁾	2.46e-01	2.46e-01	1.58e-04
Gamma-BHC	130 ⁽³⁾	1,080 ⁽⁵⁾	3.8 ⁽⁶⁾	2.46e-01	2.46e-01	1.58e-04
Alpha-chlordane	14,100 ⁽³⁾	140,000 ⁽⁵⁾	5.5 ⁽⁶⁾	2.60e-02	2.60e-02	7.94e-03
Gamma-chlordane	14,100 ⁽³⁾	140,000 ⁽⁵⁾	5.5 ⁽⁶⁾	2.60e-02	2.60e-02	7.94e-03
4,4'-DDD	53,600 ⁽³⁾	770,000 ⁽⁵⁾	6 ⁽⁶⁾	1.32e-02	1.32e-02	2.51e-02
4,4'-DDE	53,600 ⁽³⁾	4,400,000 ⁽⁵⁾	5.7 ⁽⁶⁾	2.00e-02	2.00e-02	1.26e-02
4,4'-DDT	53,600 ⁽³⁾	243,000 ⁽⁵⁾	6.4 ⁽⁶⁾	8.00e-03	8.00e-03	6.31e-02
Dieldrin	4,670 ⁽³⁾	177,828 ⁽¹¹⁾	5.3 ⁽¹¹⁾	3.20e-02	3.20e-02	2.50e+00
Endosulfan I and II	270 ⁽³⁾	3,162 ⁽¹⁰⁾	3.6 ⁽⁶⁾	-2.11e+04	-2.11e+04	-6.55e+00
Endosulfan Sulfate	270 ⁽³⁾	3,162 ⁽¹⁰⁾	3.1 ⁽⁶⁾	6.25e-01	6.25e-01	3.16e-05
Endrin	3,970 ⁽³⁾	69,183 ⁽¹²⁾	4.9 ⁽⁶⁾	5.50e-01	5.50e-01	2.09e-03
Endrin aldehyde	3,970 ⁽¹³⁾	69,183 ⁽¹³⁾	4.9 ⁽¹³⁾	5.50e-01	5.50e-01	2.09e-03
Endrin ketone	3,970 ⁽¹³⁾	69,183 ⁽¹³⁾	4.9 ⁽¹³⁾	5.50e-01	-1.44e+04	2.09e-03
Heptachlor	11,200 ⁽³⁾	12,000 ⁽⁵⁾	4.3 ⁽⁶⁾	1.27e-01	1.27e-01	5.01e-04
Heptachlor epoxide	11,200 ⁽³⁾	220 ⁽⁵⁾	4.3 ⁽⁶⁾	1.27e-01	1.27e-01	5.01e-04
PCBs, total	31,200 ⁽³⁾	530,000 ⁽⁵⁾	5.6 ⁽⁶⁾	-1.44e+03	-1.44e+03	-6.55e+02
Inorganics						
Aluminum	231 ⁽⁴⁾	ND	ND	4.00e-03	6.50e-04	1.50e-03
Antimony	1 ⁽³⁾	ND	ND	2.00e-01	3.00e-02	1.00e-03
Arsenic	44 ⁽³⁾	ND	ND	4.00e-02	6.00e-03	2.00e-03
Barium	8 ⁽⁴⁾	ND	ND	1.50e-01	1.50e-02	1.50e-04
Beryllium	19 ⁽³⁾	ND	ND	1.00e-02	1.50e-03	1.00e-03

TABLE 7-8 (Continued)

PHYSICAL/CHEMICAL CHARACTERISTICS OF THE COPCS
 SITE 36, CAMP GEIGER AREA DUMP
 REMEDIAL INVESTIGATION, CTO-0303
 MCB, CAMP LEJEUNE, NORTH CAROLINA

Contaminant of Potential Concern	BCF	Organic Carbon Partition Coefficient (mL/g)	Log Octanol/Water Coefficient	Biotransfer Factors		
				Bv ⁽¹⁾⁽²⁾	Br ⁽¹⁾⁽²⁾	Bb ⁽¹⁾⁽²⁾
Cadmium	64 ⁽³⁾	ND	ND	5.50e-01	1.50e-01	5.50e-04
Chromium	16 ⁽³⁾	ND	ND	7.50e-03	4.50e-03	5.50e-03
Cobalt	40 ⁽⁴⁾	ND	ND	2.00e-02	7.00e-03	2.00e-02
Copper	36 ⁽³⁾	ND	ND	4.00e-01	2.50e-01	1.00e-02
Iron	ND	ND	ND	4.00e-03	1.00e-03	2.00e-02
Lead	49 ⁽³⁾	ND	ND	4.50e-02	9.00e-03	3.00e-04
Manganese	35 ⁽⁴⁾	ND	ND	2.50e-01	5.00e-02	4.00e-04
Mercury	5,500 ⁽³⁾	ND	ND	9.00e-01	2.00e-01	2.50e-01
Molybdenum	ND	ND	ND	2.50e-01	6.00e-02	6.00e-03
Nickel	47 ⁽³⁾	ND	ND	6.00e-02	6.00e-02	6.00e-03
Selenium	6 ⁽³⁾	ND	ND	2.50e-02	2.50e-02	1.50e-02
Silver	0.5 ⁽³⁾	ND	ND	4.00e-01	1.00e-01	3.00e-03
Thallium	119 ⁽³⁾	ND	ND	4.00e-03	4.00e-04	4.00e-02
Vanadium	ND	ND	ND	5.50e-03	3.00e-03	2.50e-03
Zinc	47 ⁽³⁾	ND	ND	1.50e+00	9.00e-01	1.00e-01

Notes:

- (1) Baes et al., 1984 for the inorganics
- (2) The organics were calculated using Travis, 1988
- (3) USEPA, 1995a (Region IV)
- (4) USEPA, 1995b (Region III)
- (5) USEPA, 1986.
- (6) SCDM, 1991.
- (7) Montgomery and Welkon, 1990.
- (8) USEPA, 1993e (Sediment Quality Criteria for Fluoranthene)
- (9) USEPA, 1993f (Sediment Quality Criteria for Phenanthrene)
- (10) ASTDR, 1993 (Toxicological Profile for Endosulfan)
- (11) USEPA, 1993g (Sediment Quality Criteria for Dieldrin)
- (12) USEPA, 1993h (Sediment Quality Criteria for Endrin)
- (13) Used Endrin Value

BCF = Bioconcentration Factor

ND = No Data

Bv = Biotransfer factor for vegetation (stems, leaves)

Br = Biotransfer factor for vegetation (berries, fruits)

Bb = Biotransfer factor for beef

TABLE 7-9

**SAMPLING STATION CHARACTERIZATION SUMMARY
SITE 36, CAMP GEIGER AREA DUMP
REMEDIAL INVESTIGATION, CTO-0303
MCB, CAMP LEJEUNE, NORTH CAROLINA**

Station	Stream Width (ft)	Stream Depth (ft)	Canopy Cover	Sediment Description	Sediment Odor
Site 36 Stations					
36-SW/SD01	2-3	0.5	Partly Shaded	Sandy silt with some clay in 6-12" interval	Anaerobic
36-SW/SD02	3-4	0.5	Partly Shaded	Sandy/clay	Anaerobic
36-SW/SD03	3.5	0.3	Shaded	Fine silt with some fine sand, more sand in 6-12" interval	Anaerobic
36-SW/SD04	15-20	0.5	Shaded	Fine silt	Normal
36-SW/SD05 36-FS/BN03	50	3-4	Partly Open	0-1" muck, remaining 11 inches silty/sand, slight oil sheen	Slight Petroleum
36-SW/SD06 36-FS/BN02	50	4-5	Partly Open	Sandy/silt, slight oil sheen	Petroleum
36-SW/SD07 36-FS/BN01	40	3-4	Partly Open	Fine silt/sand	Anaerobic
Upstream Stations					
35-SW/SD02 35-FS/BN01	10-15	0.5	Shaded	Coarse sand	Normal
35-SW/SD03	20-30	2.5	Partly Shaded	Sand with some silt and organic material	Slight Petroleum
35-SW/SD04 35-FS/BN02	20-30	1.5	Partly Shaded	Sandy-silt, oil in water after sampling	Strong Petroleum
35-SW/SD05	20-30	2.5	Partly Shaded	Sandy-silt with much organic material, more sand in 0-6" portion, oil in water after sampling	Slight Petroleum Strong Anaerobic
35-SW/SD06 35-FS/BN03	75	3.5	Partly Open	Silt with some fine sand and organic material, more organics in 0-6" portion	Strong Petroleum
35-SW/SD07 35-BN04	20-30	1.5	Partly Shaded	Very mucky, some sand	Strong Petroleum

Notes:

SW = Surface Water Sample
SD = Sediment Sample
FS = Fish Sample
BN = Benthic Macroinvertebrate Sample

TABLE 7-10

**FIELD CHEMISTRY DATA
SITE 36, CAMP GEIGER AREA DUMP
REMEDIAL INVESTIGATION, CTO-0303
MCB, CAMP LEJEUNE, NORTH CAROLINA**

Station	Temperature (deg. C)	pH (S.U.)	Dissolved Oxygen (mg/L)	Conductivity (micromhos/cm)	Salinity (ppt)
Site 36 Stations					
36-SW/SD01	18.8	9.54	6.3	1287*	0.75*
36-SW/SD02	20	7.02	4.5	596	0
36-SW/SD03	21.9	6.8	2.4	518	0
36-SW/SD04	24	7.67	10.1	610	0
36-SW/SD05 36-FS/BN03	23.0-25.0	8.19-8.80	12.0-18.0**	1,044-3,320	0.6-1.2
36-SW/SD06 36-FS/BN02	23.3-25.3	7.57-8.80	10.3-17.9**	703-1,700	0.4-1.0
36-SW/SD07 36-FS/BN01	19.2-24.7	7.38-8.40	6.9-18.6**	570-886	0.2-0.75
Upstream Stations					
35-SW/SD02 35-FS/BN01	17.8-19.7	7.32 -7.4	8.9-9.8	282-489	0
35-SW03	17.3-21.0	7.30	8.1-8.2	510-572	0-0.1
35-SW/SD04 35-FS/BN02	16.7-19.4	6.95-7.20	5.1-7.8	269-583	0
35-SW/SD05	16.5-18.0	7.20-7.30	7.8-7.9	450-500	0-0.10
35-SW/SD06 35-FS/BN03	17.7-19.5	7.28-7.32	4.7-11.0	541-670	0-0.1
35-SW/SD07 35-BN04	19.2-21.9	7.09-7.29	5.4-7.5	291-505	0-0.20

Notes:

* Possible instrument malfunction, station is not tidally influenced

** Possible instrument malfunction, it is unlikely that the DO would be greater than 17 mg/L

Upstream sample locations collected during Site 35 investigation, April 1994.

ppt = parts per thousand

S.U. = Standard Units

NA = Not Analyzed

SW/SD = Surface water/sediment sample

BN = Benthic macroinvertebrate sample

FS = Fish sample

TABLE 7-11

**TOTAL NUMBER OF AQUATIC SPECIES COLLECTED PER STATION
 SITE 36, CAMP GEIGER AREA DUMP
 REMEDIAL INVESTIGATION, CTO-0303
 MCB, CAMP LEJEUNE, NORTH CAROLINA**

SPECIES	Site 36 Stations			Total Collected	Upstream Stations		Total Collected
	36-FS01	36-FS02	36-FS03		35-FS02	35-FS03	
American eel				0	4	1	5
Banded killifish				0	1		1
Bluegill	1			1		7	7
Brown bullhead				0	1		1
Eastern mosquitofish		1	1	2	2	1	3
Fat sleeper				0	1		1
Largemouth bass		1	2	3			0
Lesser killifish				0	2		2
Longnose gar			2	2	1	9	10
Mudcatfish (Yellow Bullhead)				0	3	10	13
Mummichog	19		2	21	3		3
Pinfish	1	2	7	10	4	7	11
Pumpkinseed	2		1	3	6	7	13
Sharptail goby		1		1			
Sheepshead	21			21	12		12
Spot			1	1	216	95	311
Stripped mullet	8	4	8	20	55	8	133
Summer flounder	1			1	1		1
Warmouth			1	1		2	2
White catfish	3	8	10	21			0
NUMBER OF SPECIES	8	6	10	14	15	10	17
NO. OF INDIVIDUALS	56	17	35	108	312	147	459
OTHER AQUATIC SPECIES							
Blue crab		11	21	32			0
Grass Shrimp			23	23			0
Crayfish				0	12	1	13
NUMBER OF SPECIES	0	1	2	2	1	1	1
NO. OF INDIVIDUALS	0	11	44	55	12	1	13

TABLE 7-12

**FISH DISTRIBUTION AND CHARACTERIZATION
SITE 36, CAMP GEIGER AREA DUMP
REMEDIAL INVESTIGATION, CTO-0303
MCB, CAMP LEJEUNE, NORTH CAROLINA**

Common Name	Scientific Name	Length N.C. (cm)	Length Atlas (cm)	Water Type	Habitat	Spawning	Tolerance	Family	Sources
American Eel	<i>Anguilla rostrata</i>	NA	to 147.5	Brackish or freshwater	NA	December	Intermediate	Anguillidae	1,2,3,4,5
Banded Killifish	<i>Fundulus diaphanus</i>	8	5-7	Freshwater, may enter brackish waters	Streams	NA	Tolerant	Cyprinodontiidae	1,2,3
Bluegill	<i>Lepomis macrochirus</i>	25	18-20	Freshwater	Rivers, Streams Creeks	May through October	Intermediate	Centrarchidae	1,2,3
Brown Bullhead	<i>Ictalurus nebulosus</i>	NA	19	Freshwater	Revers, Creeks, Ponds	Spring and Summer	Tolerant	Ictaluridae	1,2,3
Eastern Mosquitofish	<i>Gambusia holbrooki</i>	NA	2.5	Brackish or freshwater	Lakes, Creeks, Ditches	Throughout warm months	Intermediate	Poeciliidae	1,2,3,6
Fat Sleeper	<i>Dormitator maculatus</i>	10	4-25	Brackish, saltwater marshes, and freshwater	Streams, Creeks	NA	NA	Electridae	1,2
Largemouth Bass	<i>Micropterus salmoides</i>	48	12-70	Freshwater	Rivers Streams Creeks	May through June	Intermediate	Centrarchidae	1,2,3
Least Killifish	<i>Heterandria formosa</i>	2	2-3	Freshwater, may enter brackish waters	Creeks	NA	NA	Poeciliidae	1,2
Longnose Gar	<i>Lepisosteus osseus</i>	80	-150	Freshwater, may enter brackish waters	Rivers	April through May	Intermediate	Lepisosteidae	1,2,3
Mud Catfish (Yellow Bullhead)	<i>Ictalurus natalis</i>	24	38	Freshwater	Rivers Streams	April through May	Tolerant	Ictaluridae	1,2,3
Mummichog	<i>Fundulus heteroclitus</i>	7	8-10	Shallow coastal waters	Rivers Streams	April through August	NA	Cyprinodontidae	1,2,3
Pinfish	<i>Lagodon rhomboides</i>	NA	38	Marine, seldom enters freshwater	Shallow waters	NA	NA	Sparidae	1,2
Pumpkinseed	<i>Lepomis gibbosus</i>	20	8-20	Freshwater	Streams, Creeks	April through October	Moderately Tolerant	Centrarchidae	1,2,3,4

TABLE 7-12 (Continued)

**FISH DISTRIBUTION AND CHARACTERIZATION
SITE 36, CAMP GEIGER AREA DUMP
REMEDIAL INVESTIGATION, CTO-0303
MCB, CAMP LEJEUNE, NORTH CAROLINA**

Common Name	Scientific Name	Length N.C. (cm)	Length Atlas (cm)	Water Type	Habitat	Spawning	Tolerance	Family	Sources
Sharptail Goby	<i>Gobionellus hastatus</i>	NA	NA	Brackish or marine; Enters freshwater	Bays and Sounds	NA	NA	Gobiidae	2
Sheepshead	<i>Archosargus probatocephalus</i>	NA	to 76	Muddy, shallow water; Occasionally enters freshwater in Florida	Over oyster beds, Around piles and piers of bridges	NA	NA	Sparidae	2,5
Spot	<i>Leiostomas xanthurus</i>	NA	NA	Brackish or marine, enters freshwater	NA	NA	NA	Sciaenidae	1
Stripped Mullet	<i>Mugil cephalus</i>	NA	23-35	Brackish or marine, enters freshwater	Rivers	NA	NA	Mugilidae	1,2
Summer Flounder	<i>Paralichthys dentatus</i>	NA	37	Brackish or marine, enters freshwater	Rivers	NA	NA	Bothidae	1
Warmouth	<i>Lepomis gulosus</i>	16	8-26	Freshwater	Rivers, Streams	May through August	Intermediate	Centrarchidae	1,2,3
White Catfish	<i>Ictalurus catus</i>	31	46	Freshwater	Rivers	May through June	Intermediate	Ictaluridae	1,2,3

Notes:

- 1 Menhinick, 1992.
- 2 Boschung, 1983.
- 3 USEPA, 1989d.
- 4 Raasch, 1991.
- 5 Kennish, 1986.
- 6 Rohde et al., 1994

NA = Information not Available

TABLE 7-13

NUMBER AND PERCENTAGE OF BENTHIC MACROINVERTEBRATE SPECIES PER STATION
 SITE 36, CAMP GEIGER AREA DUMP
 REMEDIAL INVESTIGATION, CTO-0303
 MCB, CAMP LEJEUNE, NORTH CAROLINA

Species	Site 36 Stations			Upstream Stations		
	36-BN01	36-BN02	36-BN03	35-BN02	35-BN03	35-BN04
ANNELIDA						
Oligochaeta						
Tubificida						
Naididae						
<i>Dero digitata</i>	1 (2.3)	1 (0.3)			27 (28.1)	
<i>Stylaria lacustris</i>					8 (8.3)	
Tubificidae	1 (2.3)		1 (0.3)			
<i>Limnodrilus hoffmeisteri</i>				3 (4.6)	1 (1.0)	18 (17.8)
Polychaeta						
Capitellida						
Capitellidae						
<i>Heteromastus filiformis</i>		2 (0.6)	1 (0.3)			
Phyllodocida						
Nereidae						
<i>Nereis succinea</i>	18 (40.9)	221 (63.5)	184 (49.5)			
Spionida						
Spionidae						
<i>Polydora</i> sp.		8 (2.3)	15 (4.0)			
Terebellida						
Ampharetidae						
<i>Hypaniola grayi</i>	6 (13.6)	95 (27.3)	49 (13.2)			
ARTHROPODA						
Crustacea						

TABLE 7-13 (Continued)

NUMBER AND PERCENTAGE OF BENTHIC MACROINVERTEBRATE SPECIES PER STATION
 SITE 36, CAMP GEIGER AREA DUMP
 REMEDIAL INVESTIGATION, CTO-0303
 MCB, CAMP LEJEUNE, NORTH CAROLINA

Species	Site 36 Stations			Upstream Stations		
	36-BN01	36-BN02	36-BN03	35-BN02	35-BN03	35-BN04
Amphipoda						
Gammaridae						
<i>Gammarus tigrinus</i>		4 (1.1)	37 (9.9)		1 (1.0)	
Decapoda						
Palaemonidae						
<i>Palaemonetes pugio</i>			1 (0.3)			
Portunidae						
<i>Callinectes</i> sp.			1 (0.3)			
Insecta						
Coleoptera						
Elmidae						
<i>Dubiraphia</i> sp.				1 (1.5)		
Diptera						
Ceratopogonidae						
<i>Palpomyia/sphaeromias</i> sp. (biting midges)	1 (2.3)	1 (0.3)	1 (0.3)			1 (0.99)
Chironomidae						
<i>Chironomus decorus</i> gr.	4 (9.1)	12 (3.4)	79 (21.2)	58 (89.2)	41 (42.7)	79 (78.2)
<i>Cricotopus bicinctus</i> gr.				2 (3.08)	2 (2.1)	1 (0.99)
<i>Cricotopus ornatus</i>	10 (22.7)	2 (0.6)			5 (5.2)	
<i>Dicrotendipes modestus</i>	1 (2.3)					
<i>Dicrotendipes nervosus</i>				1 (1.5)		
<i>Polypedilum illinoense</i>					1 (1.0)	
<i>Polypedilum scalaenum</i>					6 (6.3)	

TABLE 7-14

**USEPA TOLERANCE VALUES FOR ORGANIC WASTE AND METALS, AND
NORTH CAROLINA BIOTIC INDEX FOR BENTHIC MACROINVERTEBRATES
SITE 36, CAMP GEIGER AREA DUMP
REMEDIAL INVESTIGATION, CTO-0303
MCB, CAMP LEJEUNE, NORTH CAROLINA**

Species	USEPA Tolerance Values ⁽¹⁾		NCDEHNR ⁽²⁾ Biotic Index
	Metals	Organic Wastes	
ANNELIDA			
Oligochaeta			
Lumbricina			
Lumbricidae	NA	NA	7.0
Tubificida			
Naididae			
<i>Dero digitata</i>	NA	2	10.0
<i>Stylaria lacustris</i>	NA	3	9.3
Tubificidae	NA	NA	NA
<i>Limnodrilus hoffmeisteri</i>	NA	5	9.4
Polychaeta			
Capitellida			
Capitellidae			
<i>Heteromastus filiformis</i>	NA	NA	NA
Phyllodocida			
Nereidae			
<i>Nereis succinea</i>	NA	NA	NA
Spionida			
Spionidae			
<i>Polydora sp.</i>	NA	NA	NA
Terebellida			
Ampharetidae			
<i>Hypaniola grayi</i>	NA	NA	NA
ARTHROPODA			
Crustacea			
Amphipoda			
Gammaride			
<i>Gammarus tigrinus</i>	NA	2	NA
Decapoda			
Palaemonidae			
<i>Palaemonetes pugio</i>	NA	NA	NA
Portunidae			
<i>Callinectes sp.</i>	NA	NA	NA
Insecta			
Coleoptera			

TABLE 7-14 (Continued)

USEPA TOLERANCE VALUES FOR ORGANIC WASTE AND METALS, AND
 NORTH CAROLINA BIOTIC INDEX FOR BENTHIC MACROINVERTEBRATES
 SITE 36, CAMP GEIGER AREA DUMP
 REMEDIAL INVESTIGATION, CTO-0303
 MCB, CAMP LEJEUNE, NORTH CAROLINA

Species	USEPA Tolerance Values ⁽¹⁾		NCDEHNR ⁽²⁾ Biotic Index
	Metals	Organic Wastes	
Elmidae			
<i>Dubiraphia sp.</i>	NA	NA	5.9
Diptera			
Ceratopogonidae			
<i>Palpomyia/sphaeromias sp.</i>	NA	NA	7.0
Chironomidae			
<i>Chironomus decorus gr.</i>	NA	NA	9.6
<i>Cricotopus bicinctus gr.</i>	T	2	8.5
<i>Cricotopus ornatus</i>	NA	NA	NA
<i>Dicrotendipes nervosus</i>	NA	NA	8.1
<i>Dicrotendipes modestus</i>	S	3	8.7
<i>Polypedilum illinoense</i>	T	3	9.0
<i>Polypedilum scalaenum</i>	T	2	8.4
<i>Procladius sp.</i>	NA	NA	9.1
<i>Tanytarsus sp.</i>	NA	NA	6.7
<i>Thienemannimyia gr.</i>	NA	NA	5.8
<i>Tribelos jucundum</i>	S	1	6.3
Tabanidae			
<i>Chrysops sp.</i>	NA	NA	6.7

Notes:

(1) USEPA, 1990 (Macroinvertebrate Field and Laboratory Methods for Evaluating the Biological Integrity of Surface Waters)

(2) Lenat, 1993

NA = Not Available

S = Sensitive to heavy metals

T = Tolerant to heavy metals

Organics Ranking = 0 to 5 with 0 being the least tolerant to organic wastes

TABLE 7-15

SUMMARY STATISTICS OF BENTHIC MACROINVERTEBRATE SPECIES
 SITE 36, CAMP GEIGER AREA DUMP
 REMEDIAL INVESTIGATION, CTO-0303
 MCB, CAMP LEJEUNE, NORTH CAROLINA

Station	Number of Species	Number of Individuals	Species Density (#/m ²)	Brillouin's Species Diversity	Shannon-Wiener Species Diversity	Macroinvertebrate Biotic Index
Site 36 Stations						
36-BN01	10	44	280	0.632	0.742	8.88
36-BN02	10	348	2218	0.424	0.443	9.10
36-BN03	13	372	2371	0.60	0.621	9.49
Upstream Stations						
35-BN02	5	65	414	0.176	0.208	9.48
35-BN03	12	96	612	0.649	0.718	9.44
35-BN04	5	101	644	0.266	0.290	9.47
Off-Site Background Station						
WC02	7	79	503	0.518	0.570	9.4

Notes:

#/m² = Total number of individuals per square meter

TABLE 7-16

RESULTS OF THE JACCARD COEFFICIENT (Sj) OF COMMUNITY SIMILARITY
AND SØRENSEN INDEX (Ss) OF COMMUNITY SIMILARITY BETWEEN
BENTHIC MACROINVERTEBRATE STATIONS
SITE 36, CAMP GEIGER AREA DUMP
REMEDIAL INVESTIGATION, CTO-0303
MCB, CAMP LEJEUNE, NORTH CAROLINA

Sj

STATION	35-BN02	35-BN03	35-BN04	36-BN01	36-BN02	36-BN03	WC02
35-BN02	NA	0.21	0.43	0.07	0.07	0.06	0.09
35-BN03	0.35	NA	0.31	0.16	0.29	0.19	0.19
35-BN04	0.60	0.47	NA	0.07	0.15	0.13	0.09
Ss 36-BN01	0.13	0.27	0.13	NA	0.43	0.35	0.31
36-BN02	0.13	0.45	0.27	0.60	NA	0.53	0.42
36-BN03	0.11	0.32	0.22	0.52	0.70	NA	0.43
WC02	0.17	0.32	0.17	0.47	0.59	0.60	NA

Notes:

- 35-BN02 - 35-BN04 = Upstream Stations (Brinson Creek)
- 36-BN01 - 36-BN03 = Site 36 Stations(Brinson Creek)
- WC02 = Webb Creek Station (Off-site Background Station)

TABLE 7-17

**LIST OF BIOTA SPECIES THAT WERE CHEMICALLY ANALYZED
SITE 36, CAMP GEIGER AREA DUMP
REMEDIAL INVESTIGATION, CTO-0303
MCB, CAMP LEJEUNE, NORTH CAROLINA**

Sample Number	Species	Whole Body or Fillet	Trophic Level
Site 36 Stations			
36-FS01-SM-WB01	Stripped Mullet	Whole Body	Plantivore
36-FS01-SM-F01	Stripped Mullet	Fillet	Plantivore
36-FS01-WC-F01	White Catfish	Fillet	Insectivore
36-FS02-SM-F01	Stripped Mullet	Fillet	Plantivore
36-FS02-WC-F01	White Catfish	Fillet	Insectivore
36-FS02-WC-WB01	White Catfish	Whole Body	Insectivore
36-FS02-WC-WB02	White Catfish	Whole Body	Insectivore
36-FS02-LMB-F01	Largemouth Bass	Fillet	Piscivore
36-FS02-BC01	Blue Crab	Edible Portion	Omnivore
36-FS03-SM-F01	Stripped Mullet	Fillet	Plantivore
36-FS03-WC-F01	White Catfish	Fillet	Insectivore
36-FS03-WC-F02	White Catfish	Fillet	Insectivore
36-FS03-WC-WB01	White Catfish	Whole Body	Insectivore
36-FS03-LMB-F01	Largemouth Bass	Fillet	Piscivore
36-FS03-WM-F01	Warmouth	Fillet	Insectivore
36-FS03-LG-F01	Longnose Gar	Fillet	Piscivore
36-FS03-BC01	Blue Crab	Edible Portion	Omnivore
36-FS03-BC02	Blue Crab	Edible Portion	Omnivore
Upstream Samples			
35-FS02-AE-WB01	American Eel	Whole Body	Piscivore
35-FS02-PS-WB01	Pumpkinseed	Whole Body	Insectivore
35-FS02-LG-F01	Longnose Gar	Fillet	Piscivore
35-FS02-MC-F01	Mud Catfish	Fillet	Insectivore
35-FS03-AE-WB01	American Eel	Whole Body	Piscivore
35-FS03-PS-WB01	Pumpkinseed	Whole Body	Insectivore
35-FS03-PS-WB02	Pumpkinseed	Whole Body	Insectivore
35-FS03-LG-F01	Longnose Gar	Fillet	Piscivore
35-FS03-LG-F02	Longnose Gar	Fillet	Piscivore
35-FS03-LG-WB01	Longnose Gar	Whole Body	Piscivore
35-FS03-MC-F01	Mud Catfish	Fillet	Insectivore
35-FS03-MC-WB01	Mud Catfish	Whole Body	Insectivore
35-FS03-WM-F01	Warmouth	Fillet	Insectivore
35-FS03-SM-F01	Stripped Mullet	Fillet	Plantivore
35-FS03-BG-F01	Bluegill	Fillet	Insectivore

TABLE 7-18

COMPARISON OF CONTAMINANT LEVELS IN BRINSON CREEK TISSUE SAMPLES
TO CONTAMINANT LEVELS IN TISSUE COLLECTED IN OTHER STUDIES
SITE 36, CAMP GEIGER AREA DUMP
REMEDIAL INVESTIGATION, CTO-0303
MCB, CAMP LEJEUNE, NORTH CAROLINA

Contaminant	Brinson Creek Fish Whole Body Concentrations ⁽¹⁾	Pamlico Sound Study Fish Whole Body Concentrations ⁽²⁾	Brinson Creek Fish Fillet Concentration ⁽¹⁾	Off-Site Background Fish Fillet Concentrations	Brinson Creek Crab Tissue Concentrations	Off-Site Background Crab Tissue Concentrations
Pesticides (µg/kg)						
Aldrin	2.6J (SM)	NA	5.7J-6.6J (SM)	ND	2.3J	ND
Beta-BHC	4.8J - 8.3J (WC)	20	4.2J - 11J (WM)	ND	6.8J - 8.9J	ND
Gamma-BHC	8J (SM)	NA	2.5J-5.5J (SM)	ND	2.1J-3.6J	ND
Alpha-Chlordane	2.9J - 60J (SM)	NA	3.5J - 46J (SM)	0.17	3.6J - 8.8J	1.2 - 1.8
Gamma-Chlordane	12J - 22J (SM)	NA	ND	ND	ND	ND
Dieldrin	3.2J - 59J (AE)	ND - 40	4.3J - 48J (SM)	ND	6J - 9.4J	ND
4,4'-DDD	18J - 319J (AE)	20 - 160	22J - 256J (SM)	ND	19J - 49J	5.6 - 6.6
4,4'-DDE	39J - 434J (AE)	30 - 850	39J - 572J (LG)	9.7 - 12	42J - 101J	4.6 - 8.7
4,4'-DDT	5.8J - 58J (AE)	ND - 30	2.5J - 15J (WM)	ND	2.5J	ND
Endrin	3J - 27J (SM)	ND	2.5J - 52J (LG)	ND	ND	ND
Endrin Aldehyde	3.3J - 6.5J (LG)	NA	2.8J - 13J (SM)	ND	ND	ND
Endrin Ketone	3.1J - 14J (AE)	NA	3.6J - 3.8J (WM)	ND	ND	ND
Endosulfan II	3.4J (WC)	NA	3.6J - 9.6J (LG)	ND	ND	ND
Heptachlor	7.8J (SM)	NA	2.8J-4.3J (BG)	ND	2.6J	ND
Heptachlor epoxide	ND	NA	3.9J (LG)	ND	ND	ND
Volatiles (µg/kg)						
Toluene	33J (WC)	NA	24J (SM)	ND	ND	ND

TABLE 7-18 (Continued)

COMPARISON OF CONTAMINANT LEVELS IN BRINSON CREEK TISSUE SAMPLES
TO CONTAMINANT LEVELS IN TISSUE COLLECTED IN OTHER STUDIES
SITE 36, CAMP GEIGER AREA DUMP
REMEDIAL INVESTIGATION, CTO-0303
MCB, CAMP LEJEUNE, NORTH CAROLINA

Contaminant	Brinson Creek Fish Whole Body Concentrations ⁽¹⁾	Pamlico Sound Study Fish Whole Body Concentrations ⁽²⁾	Brinson Creek Fish Fillet Concentration ⁽¹⁾	Off-Site Background Fish Fillet Concentrations	Brinson Creek Crab Tissue Concentrations	Off-Site Background Crab Tissue Concentrations
Inorganics (µg/kg)						
Aluminum	23.7 - 45.8 (SM)	NA	19.3 - 27.3 (SM)	36.5	19.3	ND
Arsenic	ND	NA	1.8 (WC)	0.34L-3.9L	1.4J	0.39-0.68
Barium	0.89 - 5.0 (SM)	NA	0.4 - 2.2 (SM)	ND	ND	10.1
Cadmium	0.25-0.88 (AE)	0.03-0.55	0.33-0.5 (LG)	ND	0.16-0.8	0.11J-0.14
Chromium	2.3 - 3.6 (WC)	0.45 - 9.73	3.0-4.0 (LMB)	0.21L - 0.68L	ND	0.52L
Cobalt	ND	NA	ND	ND	6.9	ND
Copper	3.2 - 10.9 (SM)	1.43 - 5.33	2.3 - 5.6 (SM)	0.18J - 0.46J	22.3 - 27.5	5.8 - 7.9
Iron	60.9 - 392 (LG)	NA	28 - 53.6 (WC)	ND	20.4 - 40.2	ND
Lead	2.5 (AE)	0.04 - 1.15	ND	ND	0.51J - 0.61J	ND
Manganese	1.6 - 10.3 (WC)	NA	0.86 - 3.10 (MC)	0.08J - 0.38	1.7	1.8 - 13.6
Mercury	0.68J (MC)	0.04 - 1.26	0.29J - 1.3J (LMB)	0.05 - 0.24	ND	0.02J - 0.08
Selenium	0.43J - 1.0J (WC)	NA	0.6J - 5.8J (LMB)	ND	0.72J - 0.8J	ND
Vanadium	ND	NA	1.7 (WM)	ND	ND	ND
Zinc	42.3 - 87.1 (PS)	44.9 - 67.7	18.2 - 58.3 (WC)	3.9 - 6.5	93.8 - 130	17.9 - 25

Notes:

AE = American Eel
 LG = Longnosed Gar
 LMB = Large Mouth Bass
 MC = Mud Catfish
 SM = Stripped Mullet
 WC = White Catfish

WM = Warmouth
 NA = Not Analyzed
 ND = Not Detected
⁽¹⁾ Species in parenthesis is sample with the highest detection
⁽²⁾ Benkert (1992)

TABLE 7-19

COMPARISON OF WHOLE BODY FISH TISSUE CONCENTRATIONS
 TO PROPOSED PISCIVOROUS WILDLIFE CRITERIA
 SITE 36, CAMP GEIGER AREA DUMP
 REMEDIAL INVESTIGATION, CTO-0303
 MCB, CAMP LEJEUNE, NORTH CAROLINA

Contaminant	Maximum Tissue Concentration (mg/kg)	Non-Carcinogenic Risk (mg/kg) ⁽¹⁾	Carcinogenic Risk (10 ⁻²) (mg/kg) ⁽¹⁾
Aldrin	0.0026J	0.12	0.022
Beta-BHC	0.0083J	0.1	0.51
Gamma-BHC	0.008J	0.1	0.51
Alpha-Chlordane	0.06J	0.5	0.37
Gamma-Chlordane	0.022J	0.5	0.37
Dieldrin	0.059J	0.12	0.022
4,4'-DDD	0.319J	0.2	0.266
4,4'-DDE	0.434J	0.2	0.266
4,4'-DDT	0.058J	0.2	0.266
Endrin	0.027J	0.25	NA
Endrin aldehyde	0.065J	0.25 ⁽²⁾	NA
Endrin ketone	0.014J	0.25 ⁽²⁾	NA
Heptachlor	0.0078J	0.2	0.21

Notes:

Shaded samples are contaminant concentrations that exceed the proposed criteria

⁽¹⁾ Newell et al., 1987

⁽²⁾ Used Endrin value

TABLE 7-20

**FREQUENCY AND RANGE OF CONTAMINANT DETECTIONS
 COMPARED TO SOIL FLORA AND FAUNA SCREENING VALUES
 SITE 36, CAMP GEIGER AREA DUMP
 REMEDIAL INVESTIGATION, CTO-0303
 MCB, CAMP LEJEUNE, NORTH CAROLINA**

Contaminant	Soil Flora and Fauna Screening Values ⁽¹⁾				Contaminant Frequency/Range		No. of Positive Detects Above Lowest Screening Value
	Plant	Earthworm	Invertebrate	Microorganisms and Microbial Processes	No. of Positive Detects/No. of Samples	Range of Positive Detects	
Volatiles (µg/kg)							
Toluene	200,000	100 ⁽²⁾	100 ⁽²⁾	NE	4/61	8J-98	0
Semivolatiles (µg/kg)							
Benzo(b)fluoranthene	NE	100 ⁽²⁾	100 ⁽²⁾	NE	3/57	51J-3,600	1
Bis(2-ethylhexyl)phthalate	NE	NE	NE	NE	16/57	46J-670J	NA
Butylbenzylphthalate	NE	NE	NE	NE	3/57	51J-290J	NA
Fluoranthene	NE	100 ⁽²⁾	100 ⁽²⁾	NE	5/57	54J-5,500	2
Indeno(1,2,3-cd)pyrene	NE	100 ⁽²⁾	100 ⁽²⁾	NE	3/57	46J-2,700	1
Phenanthrene	NE	100 ⁽²⁾	100 ⁽²⁾	NE	4/57	59J-2,500	2
Pyrene	NE	100 ⁽²⁾	100 ⁽²⁾	NE	8/57	41J-11,000J	5
Pesticides/PCBs (µg/kg)							
Aldrin	NE	100 ⁽²⁾	100 ⁽²⁾	NE	3/57	5.5J-1,400	1
4,4'-DDD	NE	100 ⁽²⁾	100 ⁽²⁾	NE	37/57	2.8J-550J	5
4,4'-DDE	NE	100 ⁽²⁾	100 ⁽²⁾	NE	49/57	2.2J-2,600	14
4,4'-DDT	NE	4 ⁽²⁾	4 ⁽²⁾	NE	48/57	1.8J-12,000	44
Alpha-chlordane	NE	<100 ⁽²⁾	<100 ⁽²⁾	NE	15/57	1.2J-980	1
Gamma-chlordane	NE	<100 ⁽²⁾	<100 ⁽²⁾	NE	10/57	1.2J-840	1
Dieldrin	NE	<100 ⁽²⁾	<100 ⁽²⁾	NE	21/57	2J-16,000	2
Endosulfan I	1,000 ⁽³⁾	NE	NE	NE	3/57	8.3J-36J	0
Heptachlor epoxide	NE	<100 ⁽²⁾	<100 ⁽²⁾	NE	10/57	2J-67J	0
Aroclor-1248	40,000	40 ⁽²⁾	40 ⁽²⁾	NE	9/57	68J-24,000	9
Aroclor-1254	40,000	40 ⁽²⁾	40 ⁽²⁾	NE	3/57	92-530J	3

TABLE 7-20 (Continued)

FREQUENCY AND RANGE OF CONTAMINANT DETECTIONS
 COMPARED TO SOIL FLORA AND FAUNA SCREENING VALUES
 SITE 36, CAMP GEIGER AREA DUMP
 REMEDIAL INVESTIGATION, CTO-0303
 MCB, CAMP LEJEUNE, NORTH CAROLINA

Contaminant	Soil Flora and Fauna Screening Values ⁽¹⁾				Contaminant Frequency/Range		No. of Positive Detects Above Lowest Screening Value
	Plant	Earthworm	Invertebrate	Microorganisms and Microbial Processes	No. of Positive Detects/No. of Samples	Range of Positive Detections	
Inorganics (mg/kg)							
Aluminum	50	NE	NE	600	52/52	1,010-17,600	52
Antimony	5	NE	NE	NE	7/46	3.3J-31.7J	5
Arsenic	10	60	NE	100	43/52	0.39-10.4	1
Barium	500	440 ⁽²⁾	440 ⁽²⁾	3,000	51/52	4.5-141	0
Cadmium	3	20	3	20	8/52	0.67-6.3	1
Chromium	1	0.4	0.0075 ⁽²⁾	10	52/52	1.6-51.6	52
Cobalt	20	1,500 ⁽²⁾	1,500 ⁽²⁾	1,000	10/52	0.88-9	0
Copper	100	50	20	100	39/52	0.56-445	14
Iron	100 ⁽²⁾	NE	3,515	200	52/52	863-86,200	52
Lead	50	500	300	900	48/52	4.3-836J	16
Manganese	500	330 ⁽²⁾	330 ⁽²⁾	100	52/52	2.1-940	7
Mercury	0.3	0.1	300	30	18/52	0.11-2.4	18
Nickel	30	200	NE	90	26/52	1-48.3	1
Selenium	1	70	0.26 ⁽²⁾	100	12/52	0.32-0.53	12
Silver	2	NE	NE	50	8/48	0.61-12J	4
Vanadium	2	58 ⁽²⁾	58 ⁽²⁾	20	50/52	2.9-46	50
Zinc	50	200	500	100	50/52	2.1-1,320	20

TABLE 7-20 (Continued)

**FREQUENCY AND RANGE OF CONTAMINANT DETECTIONS
COMPARED TO SOIL FLORA AND FAUNA SCREENING VALUES
SITE 36, CAMP GEIGER AREA DUMP
REMEDIAL INVESTIGATION, CTO-0303
MCB, CAMP LEJEUNE, NORTH CAROLINA**

Notes:

- (1) Will and Suter, 1994a and 1994b unless indicated otherwise (Values presented for plants, earthworms, and microorganisms and microbial processes are benchmarks below which adverse impacts to these species are not expected. Values for invertebrates are No Observed Effects Concentrations, however, they are based on less data than the benchmarks)
- (2) USEPA, 1995b (Region III BTAG Soil Screening Values for Soil Fauna)

TABLE 7-21

**EXPOSURE PARAMETERS FOR CHRONIC DAILY INTAKE MODEL
SITE 36, CAMP GEIGER AREA DUMP
REMEDIAL INVESTIGATION, CTO-0303
MCB, CAMP LEJEUNE, NORTH CAROLINA**

Exposure Parameter	Units	White-Tailed Deer	Eastern Cottontail Rabbit	Bobwhite Quail	Red Fox	Raccoon	Small Mammal (Meadow Vole)
Food Source Ingestion	NA	Vegetation 100%	Vegetation 100%	Vegetation 100%	Small Mammals 80% Vegetation 20%	Vegetation 40% Fish 60%	Vegetation 100%
Feeding Rate	kg/day	1.6 ⁽²⁾	0.237 ⁽⁴⁾	0.0135 ⁽³⁾	0.601 ⁽³⁾	0.214 ⁽⁶⁾	0.112 ⁽³⁾
Incident Soil Ingestion	kg/day	0.0185 ⁽¹⁾	0.0057 ⁽⁵⁾	0.0011 ⁽⁵⁾	0.0168 ⁽⁵⁾	0.0201 ⁽⁵⁾	0.00269 ⁽⁵⁾
Rate of Drinking Water Ingestion	L/day	1.1 ⁽²⁾	0.119 ⁽³⁾	0.0191 ⁽³⁾	0.385 ⁽³⁾	0.422 ⁽³⁾	0.0652 ⁽³⁾
Rate of Vegetation Ingestion	kg/day	1.6	0.237	0.0135	0.12	0.086	0.112
Body Weight	kg	45.4 ⁽²⁾	1.229 ⁽³⁾	0.174 ⁽³⁾	4.54 ⁽³⁾	5.12 ⁽³⁾	0.3725 ⁽³⁾
Rate of Small Mammal Ingestion	kg/day	NA	NA	NA	0.48	NA	NA
Rate of Fish Ingestion	kg/day	NA	NA	NA	NA	0.128	NA
Home Range Size	acres	454 ⁽²⁾	9.30 ⁽³⁾	26.24 ⁽³⁾	1,245 ⁽³⁾	257 ⁽³⁾	0.032 ⁽³⁾

Notes:

NA =Not Applicable

⁽¹⁾ Arthur and Alldridge, 1979⁽²⁾ Dee, 1991⁽³⁾ USEPA, 1993c⁽⁴⁾ Opresko, *et.al.*, 1994⁽⁵⁾ Beyer, 1993⁽⁶⁾ Nagy, 1987

TABLE 7-22

**FRESHWATER SURFACE WATER QUOTIENT INDEX
SITE 36, CAMP GEIGER AREA DUMP
REMEDIAL INVESTIGATION, CTO-0303
MCB, CAMP LEJEUNE, NORTH CAROLINA**

Contaminant	Station	Concentration (µg/L)	Quotient Index		
			North Carolina WQS	USEPA SWSV	
				Acute	Chronic
Inorganics (total)					
Barium	36-SW01	12.1	NA	0.2	3.2
	36-SW02	27.3	NA	0.4	7.2
	36-SW03	39.8	NA	0.6	10.5
Copper	36-SW01	56.5	8.1	4.2	6.2
Iron	36-SW01	2710	2.7	NA	2.7
	36-SW02	2320J	2.3	NA	2.3
	36-SW03	4840J	4.8	NA	4.8
Manganese	36-SW02	91.2	NA	0.1	1.1
	36-SW03	126	NA	0.1	1.6
Vanadium	36-SW01	387	NA	1.4	20.3
	36-SW02	131	NA	0.5	6.9
	36-SW03	79	NA	0.3	4.1
Inorganics (dissolved)					
Barium	36-DSW01	5.3	NA	0.1	1.4
	36-DSW02	19.1	NA	0.3	5.0
	36-DSW03	11.7	NA	0.2	3.1
Copper	36-DSW01	19	2.7	3.7	5.0
	36-DSW02	4.9	0.7	0.3	0.4
Iron	36-DSW01	1340	1.3	NA	1.3
	36-DSW02	1630	1.6	NA	1.6
	36-DSW03	1240	1.2	NA	1.2
Lead	36-DSW01	10J	0.4	0.7	16.6
	36-DSW02	16J	0.6	0.2	4.5
	36-DSW03	9J	0.4	0.1	3.6
Vanadium	36-DSW01	243	NA	0.9	12.7
	36-DSW02	143	NA	0.5	7.5
	36-DSW03	81	NA	0.3	4.2

Notes:

Shaded Samples are Quotient Indices That Exceed "1"

NE = Not Established

WQS = Water Quality Standard

SWSV = Surface Water Screening Value

TABLE 7-23

SALTWATER SURFACE WATER QUOTIENT INDEX
 SITE 36, CAMP GEIGER AREA DUMP
 REMEDIAL INVESTIGATION CTO-0303
 MCB, CAMP LEJEUNE, NORTH CAROLINA

Contaminant	Station	Concentration (µg/L)	Quotient Index		
			North Carolina WQS	USEPA SWSV	
				Acute	Chronic
Inorganics (total)					
Manganese	36-SW05	31.9	NA	NA	3.2
	36-SW06	29.5	NA	NA	3.0
	36-SW07	24.5	NA	NA	2.5
Nickel	36-SW04	23.2	2.8	0.3	2.8
Inorganics (dissolved)					
Copper	36-DSW05	4.8	1.6	1.7	1.7
Manganese	36-DSW04	50.9	NA	NA	5.1
	36-DSW05	23.8	NA	NA	2.4
	36-DSW06	26.6	NA	NA	2.7
	36-DSW07	27	NA	NA	2.7

Notes:

Shaded Samples are Quotient Indices That Exceed "1"

NE = Not Established

WQS = Water Quality Standard

SWSV = Surface Water Screening Value

TABLE 7-24

FRESHWATER SEDIMENT QUOTIENT INDEX
 SITE 36, CAMP GEIGER AREA DUMP
 REMEDIAL INVESTIGATION, CTO-0303
 MCB, CAMP LEJEUNE, NORTH CAROLINA

Contaminant	Station	Sample Concentration	Quotient Index		
			ER-L	ER-M	SQC
Pesticides (µg/kg)					
4,4'-DDD	36-SD01-06	15	7.5	0.8	1.1
	36-SD02-06	130	65.0	6.5	27.3
	36-SD02-612	14	7.0	0.7	0.7
	36-SD03-06	606	303	30.3	15.7
	36-SD03-612	1030	515	51.5	51.5
4,4'-DDE	36-SD02-06	66	30.0	2.4	2.4
	36-SD03-06	169	76.8	6.3	0.8
4,4'-DDT	36-SD02-06	8.5	8.5	1.2	5.6
	36-SD02-612	7.4	7.4	1.1	1.2
	36-SD03-06	18	18.0	2.6	1.5
	36-SD03-612	11	11.0	1.6	17.5
Dieldrin	36-SD01-06	0.8	40.0	0.1	0.1
Endrin	36-SD02-612	6.6	330.0	0.1	1.9
Endrin aldehyde	36-SD02-612	3.5	175.0	0.1	1.0
Endrin ketone	36-SD03-06	11	550.0	0.2	3.2
Semivolatiles					
Diethylphthalate	36-SD02-06	330	0.1	NA	125.0
	36-SD03-612	896	0.2	NA	807.2
Inorganics (mg/kg)					
Beryllium	36-SD01-06	1.3	2.6	NA	NA
	36-SD03-06	0.81	1.6	NA	NA
Cadmium	36-SD02-612	8.7	7.3	0.9	NA
Copper	36-SD03-06	45.1	1.3	0.2	NA
Lead	36-SD02-612	148	3.2	0.7	NA
	36-SD03-06	86.7	1.9	0.4	NA
Nickel	36-SD01-06	21.4	1.0	0.4	NA
	36-SD03-06	77.1	3.7	1.5	NA
Thallium	36-SD01-06	0.42	1.8	NA	NA
	36-SD03-06	0.32	1.3	NA	NA

Notes:

Shaded samples are Quotient Indices that exceed "1"

- NE = Not Established
- ER-L = Effects Range Low
- ER-M = Effects Range Median
- SQC = Sediment Quality Criteria

TABLE 7-25

**SALTWATER SEDIMENT QUOTIENT INDEX
SITE 36, CAMP GEIGER AREA DUMP
REMEDIAL INVESTIGATION, CTO-0303
MCB, CAMP LEJEUNE, NORTH CAROLINA**

Contaminant	Station	Sample Concentration	Quotient Index		
			ER-L	ER-M	SQC
Pesticides ($\mu\text{g}/\text{kg}$)					
Alpha-chlordane	36-SD07-06	13	26.0	2.2	0.2
	36-SD07-612	6.5	13.0	1.1	0.1
4,4'-DDD	36-SD04-06	250	125	12.5	21.6
	36-SD05-06	223	112	11.2	29.5
	36-SD05-612	-0.01739502	570	57.0	212
	36-SD06-06	-0.00337219	111	11.1	111
	36-SD06-612	-0.00242615	79.5	8.0	98.1
	36-SD07-06	-0.00112915	37.0	3.7	0.8
	36-SD07-612	-0.0006256	20.5	2.1	0.3
4,4'-DDE	36-SD04-06	120J	0	0.0	-117964.8
	36-SD05-06	242	0	0.0	0.0
	36-SD05-612	-0.018310547	545	44.4	39.0
	36-SD06-06	-0.00379944	113	9.2	21.8
	36-SD06-612	-0.00273132	81.4	6.6	19.4
	36-SD07-06	-0.0007782	23.2	1.9	0.1
	36-SD07-612	-0.0004883	14.5	1.2	0.0
4,4'-DDT	36-SD04-06	3J	0.0	-26214.4	-52428.8
	36-SD04-612	27J	0.0	0.0	0.0
	36-SD05-06	31	0.0	0.0	0.0
	36-SD05-612	-0.0007019	46.0	6.6	27.1
	36-SD06-06	-0.0002136	14.0	2.0	22.2
	36-SD06-612	-0.0001221	8.0	1.1	15.7
	36-SD07-612	-0.000087	5.7	0.8	0.1
Dieldrin	36-SD06-06	-0.0007935	2600	6.5	56.5
	36-SD07-612	-0.0002136	700	1.8	0.2
Endrin aldehyde	35-SD05-06	7.6	0	-13107.2	0.0
Semivolatiles ($\mu\text{g}/\text{kg}$)					
Diethylphthalate	36-SD05-06	-0.032577515	NA	NA	451.4

TABLE 7-25 (Continued)

SALTWATER SEDIMENT QUOTIENT INDEX
 SITE 36, CAMP GEIGER AREA DUMP
 REMEDIAL INVESTIGATION, CTO-0303
 MCB, CAMP LEJEUNE, NORTH CAROLINA

Contaminant	Station	Sample Concentration	Quotient Index		
			ER-L	ER-M	SQC
Inorganics (mg/kg)					
Beryllium	36-SD07-06	-72089.6	2.2	NA	NA
Cadmium	36-SD04-612	1.4	-78643.2	-6553.6	NA
Lead	36-SD04-612	131	0.0	-39321.6	NA
	36-SD05-06	115	0.0	-32768.0	NA
	36-SD06-06	-0.2304077148	323.0	69.3	NA
Mercury	36-SD04-612	0.66	0.0	-58982.4	NA
	36-SD08-01	0.31	2.1	0.4	NA
	36-SD09-01	0.18	1.2	0.3	NA
Thallium	36-SD05-06	-58327.04	3.7	NA	NA
	36-SD05-612	-38666.24	2.5	NA	NA
	36-SD07-06	-62914.56	4.0	NA	NA
	36-SD07-612	-35389.44	2.3	NA	NA

Notes:

Shaded samples are Quotient Indices that exceed "1"

- NE = Not Established
- ER-L = Effects Range Low
- ER-M = Effects Range Median
- SQC = Sediment Quality Criteria

TABLE 7-26

**TERRESTRIAL INTAKE MODEL QUOTIENT INDICES
SITE 36, CAMP GEIGER AREA DUMP
REMEDIAL INVESTIGATION, CTO-0303
MCB, CAMP LEJEUNE, NORTH CAROLINA**

Contaminant of Potential Concern	Red Fox	Bobwhite Quail	Cottontail Rabbit	Raccoon	Whitetail Deer
Acetone	5.77e-05	1.25e-03	1.29e-02	1.52e-01	4.53e-04
1,2-Dichloroethene (total)	2.34e-04	4.74e-05	1.73e-04	2.37e-04	1.44e-04
Toluene	6.75e-07	1.40e-05	1.36e-04	7.85e-05	4.74e-06
Benzo(b)fluoranthene	1.09e-04	1.40e-03	4.89e-03	5.62e-04	1.01e-04
Bis(2-ethylhexyl)phthalate	2.48e-04	1.08e-03	2.03e-02	1.20e-03	5.85e-04
Butylbenzylphthalate	3.59e-06	5.51e-05	3.29e-04	1.70e-05	9.82e-06
Fluoranthene	1.18e-05	1.76e-04	9.75e-04	5.70e-05	2.81e-05
Indeno(1,2,3-cd)pyrene	1.15e-04	1.48e-03	5.25e-03	5.91e-04	1.10e-04
Phenanthrene	1.91e-06	3.14e-05	2.18e-04	8.55e-06	6.89e-06
Pyrene	2.00e-05	2.89e-04	1.47e-03	9.83e-05	4.07e-05
Aldrin	6.53e-05	4.04e-03	3.85e-02	7.09e-03	1.01e-05
beta-BHC	0.00e+00	0.00e+00	0.00e+00	9.68e-05	0.00e+00
gamma-BHC	1.93e-07	3.57e-06	3.01e-05	9.90e-05	1.01e-06
Alpha-chlordane	1.34e-05	3.56e-05	3.72e-03	6.73e-02	8.20e-07
Gamma-chlordane	6.14e-06	1.63e-05	1.71e-03	1.67e-02	3.77e-07
4,4'-DDD	1.33e-05	4.43e-03	7.17e-04	1.41e-02	1.68e-05
4,4'-DDE	1.16e-04	3.95e-02	7.04e-03	3.19e-02	1.78e-04
4,4'-DDT	5.93e-05	1.91e-02	2.80e-03	2.26e-03	6.00e-05
Dieldrin	7.21e-04	3.72e-03	1.59e-01	6.17e-01	6.62e-06
Endosulfan I	1.44e-06	4.56e-06	6.97e-04	1.61e-05	2.37e-05
Endosulfan II	0.00e+00	0.00e+00	0.00e+00	3.48e-04	0.00e+00
Endrin	1.30e-05	3.56e-05	3.59e-04	5.86e-03	1.07e-05
Endrin aldehyde	1.31e-05	3.60e-05	3.63e-04	1.62e-03	1.08e-05
Endrin ketone	1.34e-05	3.68e-05	3.71e-04	3.46e-03	1.10e-05
Heptachlor	4.32e-06	7.36e-05	5.45e-04	3.21e-03	1.76e-05
Heptachlor epoxide	3.37e-03	5.73e-02	4.24e-01	1.46e-02	1.37e-02
Aroclor-1248	1.47e-04	1.52e-02	9.33e-03	5.48e-03	1.79e-03
Aroclor-1254	7.13e-06	5.92e-04	4.53e-04	3.59e-05	1.25e-04
Aluminum	2.40e-02	1.27e+00	2.70e+00	1.00e+01	2.84e-02
Antimony	6.54e-02	7.83e-01	3.61e-02	1.30e-01	2.25e-01
Arsenic	1.02e-02	1.15e-03	1.02e-02	4.36e-02	7.76e-04
Barium	7.41e-02	1.88e-01	9.19e-01	8.95e-01	8.63e-02
Cadmium	2.82e-03	6.27e-03	2.72e+00	6.12e+00	2.51e-01
Chromium	9.09e-04	5.14e-04	1.18e-03	7.80e-02	6.76e-05
Cobalt	1.96e-04	4.23e-03	1.19e-02	9.38e-04	8.08e-04
Copper	4.46e-03	8.03e-02	6.92e-01	3.39e-02	1.29e-01

TABLE 7-26 (Continued)

TERRESTRIAL INTAKE MODEL QUOTIENT INDICES
 SITE 36, CAMP GEIGER AREA DUMP
 REMEDIAL INVESTIGATION, CTO-0303
 MCB, CAMP LEJEUNE, NORTH CAROLINA

Contaminant of Potential Concern	Red Fox	Bobwhite Quail	Cottontail Rabbit	Raccoon	Whitetail Deer
Iron	6.67e-02	4.97e-01	2.12e+00	5.47e-01	7.00e-02
Lead	3.36e-03	1.45e-01	8.46e-01	2.49e-02	6.54e-02
Manganese	8.77e-03	8.62e-03	2.32e-01	7.70e-02	4.41e-02
Mercury	2.00e-03	9.23e-02	5.49e-01	1.33e-01	5.29e-02
Molybdenum	6.48e-01	1.31e-01	4.79e-01	6.55e-01	3.99e-01
Nickel	9.65e-05	1.08e-03	2.45e-02	2.30e-03	4.22e-03
Selenium	1.42e-03	1.13e-03	2.06e-02	1.54e+00	1.50e-03
Silver	7.01e-03	1.93e-03	1.22e+00	1.50e+00	4.19e-02
Thallium	6.60e-03	1.34e-03	4.87e-03	6.67e-03	4.05e-03
Vanadium	1.24e-01	3.45e-03	2.22e+00	1.45e-01	3.05e-02
Zinc	2.71e-01	2.78e-01	3.51e+00	4.03e-02	3.28e-01
Total Quotient Index	1.33e+00	3.64e+00	1.90e+01	2.29e+01	1.78e+00

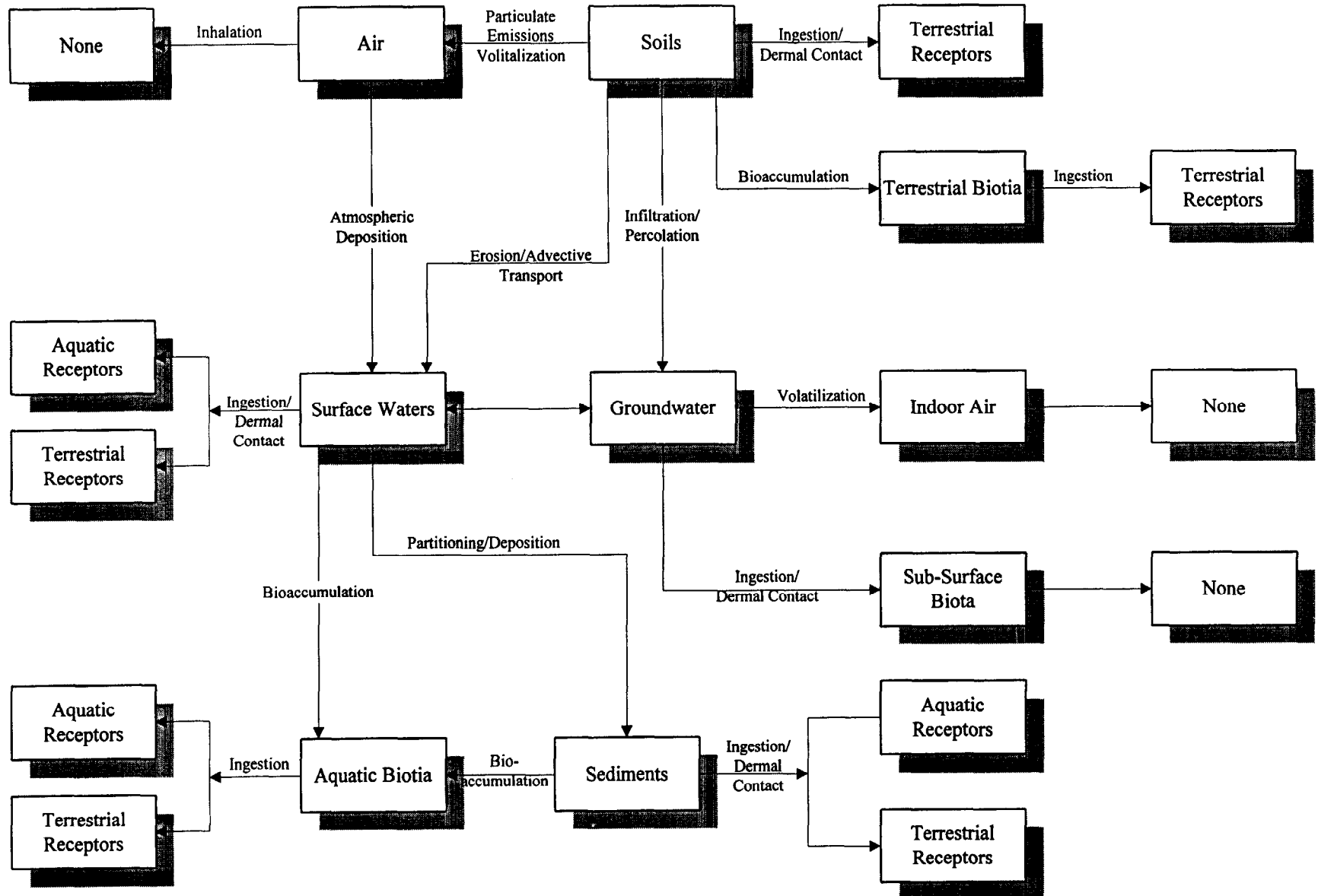
Notes:

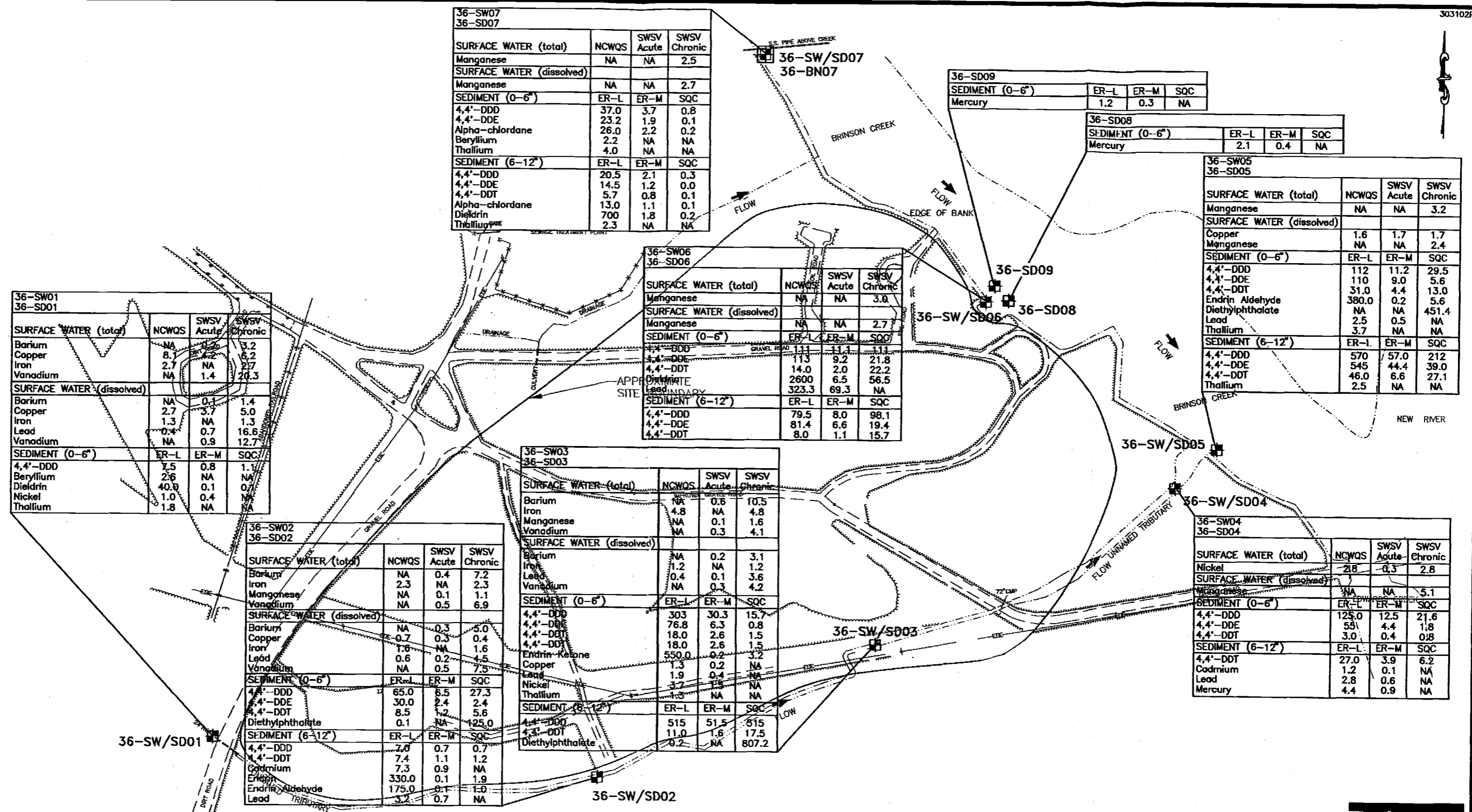
Shaded boxes are Quotient Indices that exceed "1"

SECTION 7.0 FIGURES

FIGURE 7-1

CONCEPTUAL EXPOSURE MODEL FOR ECOLOGICAL RECEPTORS
SITE 36, CAMP GEIGER AREA DUMP





36-SW07
36-SD07

SURFACE WATER (total)	NCWQS	SWSV Acute	SWSV Chronic
Manganese	NA	NA	2.5
SURFACE WATER (dissolved)			
Manganese	NA	NA	2.7
SEDIMENT (0-6")			
4,4'-DDD	ER-L	ER-M	SQC
4,4'-DDE	37.0	3.7	0.8
4,4'-DDE	23.2	1.9	0.1
Alpha-chlordane	26.0	2.2	0.2
Beryllium	2.2	NA	NA
Thallium	4.0	NA	NA
SEDIMENT (6-12")			
4,4'-DDD	ER-L	ER-M	SQC
4,4'-DDE	20.5	2.1	0.3
4,4'-DDE	14.5	1.2	0.0
4,4'-DDT	5.7	0.8	0.1
Alpha-chlordane	13.0	1.1	0.1
Dieldrin	700	1.8	0.2
Thallium	2.3	NA	NA

36-SD09

SEDIMENT (0-6")	ER-L	ER-M	SQC
Mercury	1.2	0.3	NA

36-SD08

SEDIMENT (0-6")	ER-L	ER-M	SQC
Mercury	2.1	0.4	NA

36-SW05
36-SD05

SURFACE WATER (total)	NCWQS	SWSV Acute	SWSV Chronic
Manganese	NA	NA	3.2
SURFACE WATER (dissolved)			
Copper	1.6	1.7	1.7
Manganese	NA	NA	2.4
SEDIMENT (0-6")			
4,4'-DDD	ER-L	ER-M	SQC
4,4'-DDD	112	11.2	29.5
4,4'-DDE	110	9.0	5.6
4,4'-DDT	31.0	4.4	13.0
Endrin Aldehyde	380.0	0.2	5.6
Diethylphthalate	NA	NA	451.4
Lead	2.5	0.5	NA
Thallium	3.7	NA	NA
SEDIMENT (6-12")			
4,4'-DDD	ER-L	ER-M	SQC
4,4'-DDD	570	57.0	212
4,4'-DDE	545	44.4	39.0
4,4'-DDT	46.0	6.6	27.1
Thallium	2.5	NA	NA

36-SW01
36-SD01

SURFACE WATER (total)	NCWQS	SWSV Acute	SWSV Chronic
Barium	NA	1.2	3.2
Copper	8.7	4.2	6.2
Iron	2.7	NA	2.7
Vanadium	NA	1.4	20.3
SURFACE WATER (dissolved)			
Barium	NA	0.1	1.4
Copper	2.7	3.7	5.0
Iron	1.3	NA	1.3
Lead	0.4	0.7	16.6
Vanadium	NA	0.9	12.7
SEDIMENT (0-6")			
4,4'-DDD	ER-L	ER-M	SQC
4,4'-DDD	7.5	0.8	1.1
Beryllium	2.6	NA	NA
Dieldrin	40.0	0.1	0.7
Nickel	1.0	0.4	NA
Thallium	1.8	NA	NA

36-SW06
36-SD06

SURFACE WATER (total)	NCWQS	SWSV Acute	SWSV Chronic
Manganese	NA	NA	3.8
SURFACE WATER (dissolved)			
Manganese	NA	NA	2.7
SEDIMENT (0-6")			
4,4'-DDD	ER-L	ER-M	SQC
4,4'-DDD	111	11.1	11.1
4,4'-DDE	113	9.2	21.8
4,4'-DDT	14.0	2.0	22.2
Endrin	2600	6.5	56.5
Lead	323.3	69.3	NA
SEDIMENT (6-12")			
4,4'-DDD	ER-L	ER-M	SQC
4,4'-DDD	79.5	8.0	98.1
4,4'-DDE	81.4	6.6	19.4
4,4'-DDT	8.0	1.1	15.7

36-SW03
36-SD03

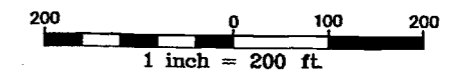
SURFACE WATER (total)	NCWQS	SWSV Acute	SWSV Chronic
Barium	NA	0.6	10.5
Iron	4.8	NA	4.8
Manganese	NA	0.1	1.6
Vanadium	NA	0.3	4.1
SURFACE WATER (dissolved)			
Barium	NA	0.2	3.1
Iron	1.2	NA	1.2
Lead	0.4	0.1	3.6
Vanadium	NA	0.3	4.2
SEDIMENT (0-6")			
4,4'-DDD	ER-L	ER-M	SQC
4,4'-DDD	303	30.3	15.7
4,4'-DDE	76.8	6.3	0.8
4,4'-DDT	18.0	2.6	1.5
4,4'-DDT	18.0	2.6	1.5
Endrin-Ketone	550.0	0.2	3.2
Copper	1.3	0.2	NA
Lead	1.9	0.4	NA
Nickel	3.7	1.5	NA
Thallium	1.3	NA	NA
SEDIMENT (6-12")			
4,4'-DDD	ER-L	ER-M	SQC
4,4'-DDD	515	51.5	515
4,4'-DDT	11.0	1.6	17.5
Diethylphthalate	0.2	NA	807.2

36-SW02
36-SD02

SURFACE WATER (total)	NCWQS	SWSV Acute	SWSV Chronic
Barium	NA	0.4	7.2
Iron	2.3	NA	2.3
Manganese	NA	0.1	1.1
Vanadium	NA	0.5	6.9
SURFACE WATER (dissolved)			
Barium	NA	0.3	5.0
Copper	0.7	0.3	0.4
Iron	1.6	NA	1.6
Lead	0.6	0.2	4.5
Vanadium	NA	0.5	7.3
SEDIMENT (0-6")			
4,4'-DDD	ER-L	ER-M	SQC
4,4'-DDD	65.0	6.5	27.3
4,4'-DDE	30.0	2.4	2.4
4,4'-DDT	8.5	1.2	5.6
Diethylphthalate	0.1	NA	125.0
SEDIMENT (6-12")			
4,4'-DDD	ER-L	ER-M	SQC
4,4'-DDD	7.6	0.7	0.7
4,4'-DDT	7.4	1.1	1.2
Cadmium	7.3	0.9	NA
Endrin	330.0	0.1	1.9
Endrin Aldehyde	175.0	0.1	1.0
Lead	3.2	0.7	NA

36-SW04
36-SD04

SURFACE WATER (total)	NCWQS	SWSV Acute	SWSV Chronic
Nickel	218	0.3	2.8
SURFACE WATER (dissolved)			
Manganese	NA	NA	5.1
SEDIMENT (0-6")			
4,4'-DDD	ER-L	ER-M	SQC
4,4'-DDD	125.0	12.5	21.6
4,4'-DDE	53	4.4	1.8
4,4'-DDT	3.0	0.4	0.8
SEDIMENT (6-12")			
4,4'-DDT	ER-L	ER-M	SQC
4,4'-DDT	27.0	3.9	6.2
Cadmium	1.2	0.1	NA
Lead	2.8	0.6	NA
Mercury	4.4	0.9	NA



LEGEND

- 36-SW/SD01 [Symbol] SURFACE WATER AND SEDIMENT SAMPLE LOCATION
- FLOW DIRECTION OF SURFACE WATER FLOW
- EOE OVERHEAD ELECTRIC LINE & UTILITY POLE
- x-x- FENCE SURFACE WATER, SEDIMENT AND BENTHIC
- ==== ASPHALT ROAD
- - - - GRAVEL ROAD
- - - - EDGE OF DRAINAGE DITCH
- ~~~~~ TREE LINE

FIGURE 7-2
QUOTIENT INDICES THAT EXCEED "1"
IN SURFACE WATER AND SEDIMENT
SITE 36, CAMP GEIGER DUMP AREA
REMEDIAL INVESTIGATION, CTO-0303
MARINE CORPS BASE, CAMP LEJEUNE
NORTH CAROLINA

01710Y05Z

8.0 CONCLUSIONS AND RECOMMENDATIONS

8.1 Conclusions

The following conclusions were derived from the RI conducted at Site 36:

- Metals are present in surface and subsurface soil predominantly in the central and eastern areas of the site (i.e., Open Field and Former Disposal Area). These areas correspond to former buried material and fill locations at the site. Copper, lead, and zinc were the primary metals of concern. Iron and lead in the subsurface soils represent a potential risk to human health. There are some potential ecological impacts from exposure to metals in site soils.
- PCBs are present in surface and subsurface soils in well-defined areas, primarily near the western boundary at the access road. PCBs in soil were evaluated for potential human health risk. The calculated risks from soil exposure were within acceptable levels.
- VOCs in groundwater are primarily limited to the northern portion of the site. This area was not included in the original study area but was added to the study based on preliminary findings. After an examination of historical aerial photographs, an approximately 2-acre ground scar was noted in this northern area. The primary volatile compounds of concern are 1,2-dichloroethene (total), trichloroethene, 1,1,2,2-tetrachloroethene, and tetrachloroethene.
- The horizontal extent of VOCs in groundwater appears to be limited to the northern portion of the study area. This area has not been fully evaluated along its southern boundary although several wells downgradient from the affected area did not indicate the presence of VOCs.
- VOC occurrence in groundwater is limited to the surficial aquifer. They are present in the lower portion of the surficial aquifer but do not appear to have migrated into the underlying Castle Hayne aquifer. It is likely that surficial aquifer is discharging into Brinson Creek based on the groundwater flow pattern at the site, although VOCs were not detected in surface water.
- Potential human health risk from exposure to organics in site groundwater were evaluated. No unacceptable levels of risk were found.
- Iron, manganese, and mercury were detected in groundwater at concentrations above state drinking water levels. The maximum levels of these metals were found predominantly in the Former Disposal and Open Field areas (i.e., buried and fill materials). Human health evaluations calculated from exposure to iron in groundwater yielded a site risk.
- Copper, iron, and nickel were found in surface water at concentrations greater than federal screening levels. Nickel, manganese, copper, lead, and iron exceeded ecological criteria. Human health risks calculated from exposure to surface water were within acceptable risk levels.

- Cadmium, lead, mercury, nickel, and zinc are present in sediment. Lead in sediment generated an ecological risk. Pesticides in sediment generated the most significant ecological risk. Human health risks calculated from exposure to sediment were within acceptable ranges.
- Based upon results of the sampling, benthic macroinvertebrates do not appear to be impacted by site media. Currently, arsenic and mercury in fish tissue and arsenic and lead in crab tissue pose potential risk to human health.

8.2 **Recommendations**

The following recommendations are provided based on the RI findings:

- Surface soil in the vicinity of borings 36-OF-SB03, 36-OA-SB01I, 36-OA-SB01A, and 36-OF-SB04 may require additional sampling as part of the remedial actions. Although these areas of concern did not generate a human health risk, the concentrations of organic compounds are relatively high compared to other areas investigated within Site 36.
- Groundwater within northern portion of Site 36, the surficial and Castle Hayne aquifers, should be sampled as part of a long-term monitoring plan due to the presence of volatile compounds. In addition, Brinson Creek should also be sampled as part of the long-term monitoring.