

03.13-08/22/96-01713

FINAL

**REMEDIAL INVESTIGATION REPORT
OPERABLE UNIT NO. 6
(SITE 43)
VOLUME IV
MARINE CORPS BASE
CAMP LEJEUNE, NORTH CAROLINA**

**CONTRACT TASK ORDER 0303
TEXT AND FIGURES**

AUGUST 22, 1996

Prepared For:

**DEPARTMENT OF THE NAVY
ATLANTIC DIVISION
NAVAL FACILITIES
ENGINEERING COMMAND
*Norfolk, Virginia***

Under:

**LANTDIV CLEAN Program
Contract N62470-89-D-4814**

Prepared by:

**BAKER ENVIRONMENTAL, INC.
*Coraopolis, Pennsylvania***

TABLE OF CONTENTS

	<u>Page</u>
EXECUTIVE SUMMARY	ES-1
1.0 INTRODUCTION	1-1
1.1 Report Organization	1-1
1.2 Background and Setting of MCB, Camp Lejeune	1-2
1.2.1 Location and Setting	1-2
1.2.2 History	1-2
1.2.3 Operable Unit Description	1-2
1.2.4 Topography	1-3
1.2.5 Surface Water Hydrology	1-3
1.2.6 Geology	1-3
1.2.7 Hydrogeology	1-4
1.2.8 Ecology	1-5
1.2.9 Land Use Demographics	1-9
1.2.10 Meteorology	1-10
1.3 Background and Setting of Site 43	1-10
1.3.1 Site Location and Setting	1-10
1.3.2 Site History	1-11
1.4 Previous Investigations	1-11
1.4.1 Initial Assessment Study	1-11
1.4.2 Site Inspection	1-11
1.4.3 Additional Investigations	1-13
1.5 Remedial Investigation Objectives	1-13
1.6 References	1-14
2.0 SITE CHARACTERISTICS	2-1
2.1 Topography and Surface Features	2-1
2.2 Surface Water Hydrology	2-1
2.3 Soil	2-1
2.4 Geology	2-1
2.5 Hydrogeology	2-2
2.5.1 Groundwater Elevation Data	2-3
2.5.2 Groundwater Flow Contour Maps	2-3
2.5.3 Hydraulic Properties	2-4
2.5.4 Groundwater Flow Velocities	2-5
2.5.5 General Groundwater Flow Patterns	2-5
2.6 Identification of Water Supply Wells	2-6
2.7 Ecology	2-6
2.8 References	2-8
3.0 STUDY AREA INVESTIGATIONS	3-1
3.1 Site Survey	3-1
3.2 Soil Investigation	3-1
3.2.1 Soil Sampling Procedures	3-2

TABLE OF CONTENTS
(Continued)

	<u>Page</u>
3.2.2	Sampling Locations 3-3
3.2.3	Exploratory Test Pits 3-3
3.2.4	Analytical Program 3-4
3.2.5	Quality Assurance and Quality Control 3-4
3.2.6	Air Monitoring and Field Screening 3-5
3.3	Groundwater Investigation 3-6
3.3.1	Monitoring Well Installation 3-6
3.3.2	Monitoring Well Development 3-7
3.3.3	Water Level Measurements 3-8
3.3.4	Aquifer Testing 3-8
3.3.5	Sampling Locations 3-8
3.3.6	Sampling Procedures 3-8
3.3.7	Analytical Program 3-9
3.3.8	Quality Assurance and Quality Control 3-9
3.3.9	Field Screening and Air Monitoring 3-9
3.4	Surface Water and Sediment Investigations 3-10
3.4.1	Sampling Locations 3-10
3.4.2	Sampling Procedures 3-10
3.4.3	Analytical Program 3-10
3.4.4	Quality Assurance and Quality Control 3-11
3.5	Ecological Investigation 3-11
3.6	Decontamination Procedures 3-11
3.7	Investigation Derived Waste (IDW) Handling 3-12
3.8	References 3-12
4.0	NATURE AND EXTENT OF CONTAMINATION 4-1
4.1	Data Quality 4-1
4.1.1	Data Management and Tracking 4-1
4.2	Non-Site Related Analytical Results 4-2
4.2.1	Laboratory Contaminants 4-2
4.2.2	Naturally-Occurring Inorganic Analytes 4-3
4.3	Analytical Results 4-5
4.3.1	Soil Investigation 4-5
4.3.2	Groundwater Investigation 4-7
4.3.3	Surface Water Investigation 4-9
4.3.4	Sediment Investigation 4-10
4.4	Extent of Contamination 4-12
4.4.1	Extent of Soil Contamination 4-12
4.4.2	Extent of Groundwater Contamination 4-13
4.4.3	Extent of Surface Water Contamination 4-14
4.4.4	Extent of Sediment Contamination 4-16
4.5	References 4-18

TABLE OF CONTENTS
(Continued)

		<u>Page</u>
5.0	CONTAMINANT FATE AND TRANSPORT	5-1
5.1	Chemical and Physical Properties Impacting Fate and Transport	5-1
5.2	Contaminant Transport Pathways	5-2
5.2.1	Windblown Dust	5-3
5.2.2	Leaching of Sediment Contaminants to Surface Water	5-3
5.2.3	Migration of Contaminants in Surface Water	5-3
5.2.4	Leaching of Soil Contaminants to Groundwater	5-4
5.3	Fate and Transport Summary	5-4
5.3.1	Volatile Organic Compounds (VOCs)	5-4
5.3.2	Semivolatile Organic Compounds (SVOCs)	5-4
5.3.3	Pesticides	5-5
5.3.4	Metals	5-5
5.4	References	5-6
6.0	BASELINE HUMAN HEALTH RISK ASSESSMENT	6-1
6.1	Introduction	6-1
6.2	Hazard Identification	6-2
6.2.1	Data Evaluation and Reduction	6-2
6.2.2	Identification of Data Suitable for Use in a Quantitative Risk Assessment	6-3
6.2.3	Criteria Used in Selection of COPCs	6-3
6.2.4	Contaminants of Potential Concern (COPCs)	6-8
6.3	Exposure Assessment	6-11
6.3.1	Potential Human Receptors and Adjacent Populations	6-11
6.3.2	Migration and Exposure Pathways	6-12
6.3.3	Quantification of Exposure	6-15
6.3.4	Calculation of Chronic Daily Intakes	6-17
6.4	Toxicity Assessment	6-26
6.4.1	Carcinogenic Slope Factor	6-27
6.4.2	Reference Dose	6-27
6.4.3	Lead	6-29
6.4.4	Dermal Adjustment of Toxicity Factors	6-29
6.5	Risk Characterization	6-30
6.5.1	Human Health Risks	6-30
6.6	Sources of Uncertainty	6-32
6.6.1	Analytical Data	6-33
6.6.2	Exposure Assessment	6-33
6.6.3	Sampling Strategy	6-34
6.6.4	Toxicity Assessment	6-35
6.7	Conclusions of the BRA for Site 43	6-35
6.7.1	Current Scenario	6-36
6.7.2	Future Scenario	6-36
6.8	References	6-36

TABLE OF CONTENTS
(Continued)

	<u>Page</u>
7.0	ECOLOGICAL RISK ASSESSMENT 7-1
7.1	Objectives, Scope, and Organization of the Ecological Risk Assessment . . . 7-1
7.2	Problem Formulation 7-2
7.3	Contaminants of Potential Concern 7-2
7.3.1	Criteria for Selecting Contaminants of Potential Concern 7-2
7.3.2	Selection of Contaminants of Potential Concern 7-6
7.3.3	Physical/Chemical Characteristics of COPCs 7-8
7.4	Ecosystems Potentially at Risk 7-9
7.5	Ecological Endpoints 7-9
7.5.1	Aquatic Endpoints 7-10
7.5.2	Terrestrial Endpoints 7-10
7.6	Conceptual Model 7-10
7.6.1	Soil Exposure Pathway 7-10
7.6.2	Groundwater Exposure Pathway 7-11
7.6.3	Surface Water and Sediment Exposure Pathway 7-11
7.6.4	Air Exposure Pathway 7-12
7.7	Exposure Assessment 7-12
7.7.1	Surface Water, Sediment, and Bioassay Sampling 7-12
7.8	Ecological Effects Characterization 7-15
7.8.1	Surface Water 7-15
7.8.2	Sediment 7-15
7.8.4	Surface Soil 7-16
7.8.5	Terrestrial Chronic Daily Intake Model 7-16
7.9	Risk Characterization 7-18
7.9.1	Surface Water 7-19
7.9.2	Sediment 7-19
7.9.3	Terrestrial Chronic Daily Intake Model 7-19
7.10	Ecological Significance 7-20
7.10.1	Aquatic Endpoints 7-20
7.10.2	Terrestrial Endpoints 7-21
7.10.3	Threatened and Endangered Species 7-21
7.10.4	Wetlands 7-21
7.11	Uncertainty Analysis 7-21
7.12	Conclusions 7-23
7.12.1	Aquatic Ecosystem 7-23
7.12.2	Terrestrial Ecosystem 7-24
7.13	References 7-24
8.0	CONCLUSIONS AND RECOMMENDATIONS 8-1
8.1	Conclusions 8-1
8.2	Recommendations 8-1

APPENDICES

A	Test Boring Records
B	Test Boring and Well Construction Records
C	Exploratory Test Pit Records
D	Chain-of-Custody Forms
E	Field Well Development Records
F	Investigation Derived Waste Summary and Recommendations
G	Sampling Summary
H	Data and Frequency Summaries
I	Statistical Summaries
J	Field Duplicate Summaries
K	QA/QC Sampling Summary
L	Grain Size, Permeability and TPH Analytical Results
M	Wet Chemistry Analytical Results
N	Aquifer Test Results
O	Aquifer Property Calculations
P	Base Background Analytical Results and Evaluation Report
Q	Site Conceptual Model
R	CDI Calculations
S	Field Data Sheets
T	White Oak River Basin Reference Stations
U	Screening Value and Quotient Index Calculations
V	Terrestrial Reference Values and CDI Calculations
W	Bioassay Testing Results

LIST OF TABLES

- ES-1 Summary of Site Contamination
 - 1-1 Geologic and Hydrogeologic Units of North Carolina's Coastal Plain
 - 1-2 Summary of Hydraulic Properties Unrelated Site Investigations
 - 1-3 Hydraulic Property Estimates of the Castle Hayne Aquifer
 - 1-4 Protected Species Within MCB, Camp Lejeune
 - 1-5 Land Utilization Within Developed Areas of MCB, Camp Lejeune
 - 1-6 Climatic Data Summary Marine Corps Air Station, New River
 - 1-7 Summary of Well Construction Details Site Inspection
 - 1-8 Detected Organic Contaminants in Soil Site Inspection
 - 1-9 Detected Inorganic Contaminants in Soil Site Inspection
 - 1-10 Detected Target Contaminants in Groundwater Site Inspection
 - 1-11 Detected Target Contaminants in Surface Water Site Inspection
 - 1-12 Detected Target Contaminants in Sediment Site Inspection
 - 1-13 Detected Target Contaminants in Groundwater RI Scoping Investigation
 - 1-14 Remedial Investigation Objectives Site 43, Agan Street Dump

- 2-1 Summary of Soil Physical Properties
- 2-2 Summary of Groundwater and Surface Water Elevations
- 2-3 Hydraulic Properties Summary
- 2-4 Summary of Potable Water Supply Wells Within a One-mile Radius

- 3-1 Soil Sampling Summary Test Borings
- 3-2 Soil Sampling Summary Monitoring Well Test Borings
- 3-3 Quality Assurance/Quality Control Sampling Program Soil Investigation
- 3-4 Summary of Well Construction Details
- 3-5 Summary of Water Level Measurements
- 3-6 Summary of Groundwater Field Parameters
- 3-7 Groundwater Sampling Summary
- 3-8 Quality Assurance/Quality Control Sampling Program Groundwater Investigation
- 3-9 Summary of Surface Water Field Parameters
- 3-10 Surface Water and Sediment Sampling Summary
- 3-11 Quality Assurance/Quality Control Sampling Program Surface Water and Sediment Investigation

- 4-1 Summary of Rejected Data
- 4-2 Summary of Site Contamination
- 4-3 Surface Soil - Positive Detection Summary, TCL Organics
- 4-4 Surface Soil - Positive Detection Summary, TAL Metals
- 4-5 Subsurface Soil - Positive Detection Summary, TCL Organics
- 4-6 Subsurface Soil - Positive Detection Summary, TAL Metals
- 4-7 Groundwater - Positive Detection Summary, TCL Organics
- 4-8 Groundwater - Positive Detection Summary, TAL Metals
- 4-9 Groundwater - Positive Detection Summary, TAL Dissolved Metals
- 4-10 Surface Water - Positive Detection Summary, TCL Organics
- 4-11 Surface Water - Positive Detection Summary, TAL Metals
- 4-12 Surface Water - Positive Detection Summary, TAL Dissolved Metals

LIST OF TABLES (Continued)

- 4-13 Sediment - Positive Detection Summary, TCL Organics
- 4-14 Sediment - Positive Detection Summary, TAL Metals

- 5-1 Organic Physical and Chemical Properties
- 5-2 Relative Mobilities of Metals as a function of Environmental Conditions (Eh, pH)

- 6-1 Contaminants of Potential Concern Organics in Surface Soil
- 6-2 Contaminants of Potential Concern Inorganics in Surface Soil
- 6-3 Contaminants of Potential Concern Organics in Subsurface Soil
- 6-4 Contaminants of Potential Concern Inorganics in Subsurface Soil
- 6-5 Contaminants of Potential Concern in Groundwater
- 6-6 Contaminants of Potential Concern in Surface Water
- 6-7 Contaminants of Potential Concern in Sediment
- 6-8 Summary of Exposure Dose Input Parameters
- 6-9 Summary of Exposure Pathways
- 6-10 Summary of Health-Based Criteria
- 6-11 Summary of Dermal Adjusted Health-Based Criteria
- 6-12 Summary of Risks for the Military Receptor
- 6-13 Summary of Risks for the Child Trespasser
- 6-14 Summary of Risks for the Future Child Resident
- 6-15 Summary of Risks for the Adult Trespasser
- 6-16 Summary of Risks for the Future Adult Resident
- 6-17 Summary of Risks for the Construction Worker
- 6-18 Summary of Uncertainties in the Results of the Human Health Risk Assessment
- 6-19 Summary of Contaminants Contributing to Site Risks

- 7-1 Frequency and Range of Contaminant Detections Compared to Saltwater Surface Water Screening Values
- 7-2 Frequency and Range of Dissolved Metals Detections Compared to Saltwater Surface Water Screening Values
- 7-3 Frequency and Range of Contaminant Detections Compared to Saltwater Sediment Reference Values
- 7-4 Contaminants of Concern in Each Media
- 7-5 Physical/Chemical Characteristics of the COPCs
- 7-6 Sampling Station Characterization Summary
- 7-7 Field Chemistry Data
- 7-8 Frequency and Range of Contaminant Detections Compared to Soil Flora and Fauna Screening Values
- 7-9 Exposure Factors for Terrestrial Chronic Daily Intake Model
- 7-10 Surface Water Quotient Index
- 7-11 Frequency and Range of Contaminant Detections Compared to Saltwater Sediment Screening Values
- 7-12 Terrestrial Intake Model Quotient Indices

LIST OF FIGURES

- 1-1 Operable Unit No. 6 - Sites 36, 43, 44, 54, and 86
- 1-2 Operable Unit and Site Locations
- 1-3 Locations of Hydrogeologic Cross-Sections
- 1-4 Hydrogeologic Cross-Sections
- 1-5 Site Map, Site 43 - Agan Street Dump
- 1-6 Site Inspection Sampling Locations

- 2-1 Cross-section Location Map
- 2-2 Geologic Cross-sections A-A' through E'E'
- 2-3A Groundwater Elevation Trends
- 2-3B Groundwater Elevation Trends
- 2-4 Surficial/Aquifer Groundwater Contour Map
- 2-5 Deep Groundwater Contour Map
- 2-6 Potable Water Supply Wells within a One-Mile Radius
- 2-7 Biohabitat Map

- 3-1 Soil Sampling Locations
- 3-2 Monitoring Well Locations
- 3-3 Typical Shallow Type II Groundwater Monitoring Well Construction Diagram
- 3-4 Typical Deep Type III Groundwater Monitoring Well Construction Diagram
- 3-5 Surface Water and Sediment Sampling Locations

- 4-1 Organic Compounds in Surface Soil
- 4-2 Organic Compounds in Subsurface Soil
- 4-3 Organic Compounds in Groundwater
- 4-4 TAL Metals in Groundwater Above Screening Standards
- 4-5 Organic Compounds in Surface Water
- 4-6 TAL Metals in Surface Water Above Screening Values
- 4-7 Organic Compounds in Sediment
- 4-8 TAL Metals in Sediment Above Screening Values

- 6-1 Flowchart of Potential Exposure Pathways and Receptors

- 7-1 Conceptual Exposure Model for Ecological Receptors
- 7-2 Quotient Indices that Exceeded "1" in Surface Water and Sediment

LIST OF ACRONYMS AND ABBREVIATIONS

AET	Apparent Effects Threshold
AQUIRE	Aquatic Information Retrieval Database
ARAR	Applicable or Relevant and Appropriate Requirement
AST	Above Ground Storage Tank
ASTM	American Society for Testing and Materials
ATSDR	Agency for Toxic Substances and Disease Registry
AWQC	Ambient Water Quality Criteria
BaB	Baymeade
Baker	Baker Environmental, Incorporated
Bb	Beef Biotransfer Factor
BCF	Bioconcentration Factor
BEHP	Bis(2-ethylhexyl)phthalate
bgs	Below Ground Surface
BI	Biotic Index
Br	Plant Biotransfer Factor (fruit)
BRA	Baseline Human Health Risk Assessment
BTEX	Benzene, Toluene, Ethylbenzene, and Xylene
Bv	Plant Biotransfer Factor (leaf)
°C	Degrees Celsius
Carc.	Carcinogenic Effects
CDI	Chronic Daily Intake
CERCLA	Comprehensive Environmental Response, Compensation and Liability Act
CLEJ	Camp Lejeune
CLP	Contract Laboratory Program
COC	Contaminant of Concern
COPC	Contaminant of Potential Concern
CRAVE	Carcinogen Risk Assessment Verification Endeavor
CRDL	Contract Required Detection Limit
CRQL	Contract Required Quantitation Limit
CSF	Carcinogenic Slope Factor
DC	Direct Current
DEM	Division of Environmental Management
DO	Dissolved Oxygen
DOD	Department of the Defense
DoN	Department of the Navy
DQO	Data Quality Objective
EDB	Ethyl Dibromide
EMD	Environmental Management Division (Camp Lejeune)
EPIC	Environmental Photographic Interpretation Center
ER-L	Effects Range - Low
ER-M	Effects Range - Median
ERA	Ecological Risk Assessment
ESE	Environmental Science and Engineering

LIST OF ACRONYMS AND ABBREVIATIONS
(Continued)

°F	Degrees Fahrenheit
FFA	Federal Facilities Agreement
FID	Flame Ionization Detector
ft	Feet
FWS	Fish and Wildlife Service
gpm	Gallons per Minute
GW	Groundwater Well
H'	Species Diversity (Shannon-Wiener)
H	Species Diversity (Brillouins')
HA	Health Advisories
HEAST	Health Effects Assessment Summary Tables
HHAG	Human Health Assessment Group
HI	Hazard Index
HPIA	Hadnot Point Industrial Area
HQ	Hazard Quotient
IAS	Initial Assessment Study
ICR	Estimated Incremental Lifetime Cancer Risk
ID	Internal Diameter
IDW	Investigation Derived Waste
IRIS	Integrated Risk Information System
IRP	Installation Restoration Program
K_{oc}	Organic Carbon Partition Coefficient
K_{ow}	Octanol Water Partition Coefficient
LANTDIV	Naval Facilities Engineering Command, Atlantic Division
LOAEL	Lowest-Observed-Adverse-Effect-Level
MAG	Marine Air Groups
MBI	Macroinvertebrate Biotic Index
MCAS	Marine Corps Air Station
MCB	Marine Corps Base
MCL	Maximum Contaminant Level
MEK	Methyl Ethyl Ketone
MF	Modifying Factor
mg/L	Milligrams per Liter
mg/kg	Milligrams per Kilogram
MI	Mobility Index
MIBK	Methyl Isobutyl Ketone
MS/MSD	Matrix Spike and Matrix Spike Duplicate
msl	Mean Sea Level

LIST OF ACRONYMS AND ABBREVIATIONS
(Continued)

NC DEHNR	North Carolina Department of Environment, Health, and Natural Resources
NCP	National Contingency Plan
NCWQS	North Carolina Water Quality Standards
ND	Nondetect
NEESA	Naval Energy and Environmental Support Activity
NEHC	Navy Environmental Health Center
NFESC	Naval Facilities Engineering Service Center
NOAA	National Oceanic and Atmospheric Administration
NOAEL	No-Observed-Adverse-Effect-Level
NOEL	No-Observed-Effect Level
Noncarc.	Noncarcinogenic Effects
NPL	National Priorities List
NWI	National Wetlands Inventory
O&G	Oil and Grease
ORNL	Oak Ridge National Laboratory
OSWER	Office of Solid Waste and Emergency Response
OU	Operable Unit
PAH	Polynuclear Aromatic Hydrocarbon
PCB	Polychlorinated Biphenyl
PID	Photoionization Detector
ppb	Parts per Billion
ppm	Parts per Million
PVC	Polyvinyl Chloride
QA/QC	Quality Assurance/Quality Control
QI	Quotient Index
R	Retardation Factor
RA	Risk Assessment
RBC	Region III Risk-Based Concentration
RCRA	Resource Conservation and Recovery Act
RfD	Reference Dose
RI/FS	Remedial Investigation/Feasibility Study
RI	Remedial Investigation
RME	Reasonable Maximum Exposure
ROD	Record of Decision
S	Solubility
SA	Site Assessment
SAP	Sampling and Analysis Plan
SCS	Soil Conservation Service
SD	Sediment
SI	Suite Investigation
Sj	Jaccard Coefficient

LIST OF ACRONYMS AND ABBREVIATIONS

(Continued)

SM-SP	Fine Sand and Loamy Fine Sand
SMCL	Secondary Maximum Contaminant Level
SOP	Standard Operating Procedure
SQC	Sediment Quality Criteria
S _s	Sørensen Index
SSL	Sediment Screening Level
SSV	Sediment Screening Value
SSSV	Surface Soil Screening Value
STP	Sewage Treatment Plant
SU	Standard Unit
SVOC	Semivolatile Organic Compound
SW	Surface Water
SWSV	Surface Water Screening Value
TAL	Target Analyte List
TBC	To Be Considered
TCE	Trichloroethylene
TCL	Target Compound List
TCLP	Toxicity Characteristic Leaching Procedure
TDS	Total Dissolved Solids
TIC	Tentatively Identified Compound
TOC	Total Organic Carbon
TOC	Top-of-Casing
TPH	Total Petroleum Hydrocarbon
TRV	Terrestrial Reference Value
TSS	Total Suspended Solids
µg/L	Micrograms per Liter
µg/g	Micrograms per Gram
µg/kg	Micrograms per Kilogram
UBK	Uptake/Biokinetics
UCL	Upper Confidence Limit
UF	Uncertainty Factor
USCS	Unified Soil Classification System
USEPA	United States Environmental Protection Agency
USGS	United States Geological Survey
UST	Underground Storage Tank
VOC	Volatile Organic Compound
VP	Vapor Pressure
WAR	Water and Air Research, Incorporated
WOE	Weight-of-Evidence
WQS	Water Quality Standards
WQSV	Water Quality Screening Values

EXECUTIVE SUMMARY

INTRODUCTION

The purpose of an RI is to evaluate the nature and extent of the threat to public health and the environment caused by the release or threatened release of hazardous substances, pollutants, or contaminants. This RI investigation was conducted through the sampling of several environmental media (soil, groundwater, surface water, sediment, and fish tissue) at OU No. 6, evaluating the resultant analytical data, and performing a human health risk assessment (RA) and ecological RA. This RI report contains the results of all field investigations, the human health RA, and the ecological RA. Furthermore, the RI report provides information to support the FS and Record of Decision (ROD) documents.

Operable Unit Description

OU No. 6 is located within the northwest portion of the facility, to the south and east of Camp Geiger Development Area. Site 36 is referred to as the "Camp Geiger Area Dump," Site 43 is the "Agan Street Dump," Site 44 is known as the "Jones Street Dump," Site 54 is the "Crash Crew Fire Training Burn Pit," and Site 86 is known as the "Tank Area AS419-AS421 at MCAS."

Site Description and History

The Agan Street Dump (Site 43) is comprised of approximately 11 acres and is located within the operations area of MCAS, New River, two miles west of the main entrance. Vehicle access to the site is via Agan Street, from Curtis Road.

The Agan Street Dump is located at the northern terminus of Agan Street, adjacent to an abandoned sewage disposal facility. The site is bordered to the north by Edwards Creek, to the east and south by Strawhorn Creek, and to the west by Agan Street and the former sewage disposal facility. Strawhorn Creek discharges into Edwards Creek at Site 43. Edwards Creek then discharges into the New River approximately 2,000 feet north of the study area, near Site 36.

Much of the site is heavily vegetated with dense understory and trees greater than three inches in diameter. Marsh areas that are prone to flooding line both Strawhorn and Edwards Creeks. An improved gravel loop road provides access to the main portion of the study area; other unimproved paths extend outward from this road. Base housing units and related facilities are situated to west, on the opposite side of Agan Street. A child daycare/minischool is located approximately 250 feet southwest of the study area boundary.

The Agan Street Dump reportedly received mainly inert material such as construction debris (i.e., fiberglass and lumber) and trash. Sludge from a former sewage disposal facility, located adjacent to the study area, was also dumped onto the ground surface of Site 43 (WAR, 1983). The years during which disposal operations took place are not known.

GEOLOGY

A depositional sequence was observed in the deep well borings at Site 43 that matches the sequence discussed in the U.S. Geological Survey's hydrogeologic assessment of Camp Lejeune (Cardinell,

et al., 1993). The uppermost formation at Site 43 called is the undifferentiated formation. The Belgrade Formation lies below, with the River Bend Formation below that.

The uppermost formation at Site 43, the undifferentiated formation is comprised of two units of Holocene and Pleistocene ages. This formation extends to a depth between 33 and 38 feet bgs. The upper unit consists of a fine sand with lesser amounts of medium and coarse sand, silt and clay. This unit is approximately 20 feet thick, and tends to be loose to medium dense. A fine to medium sand with a lesser amount of shell fragments and silt lies below the upper sand. This fine to medium sand unit is 12 to 18 feet thick, and tends to be medium dense to dense. Lenses of silts and clays were sporadically encountered in the undifferentiated formation.

The Belgrade Formation, is comprised of fine sand, with lesser amounts of silt and clay of the Miocene age. The top of this Formation lies 33 to 38 feet bgs, is approximately 16 feet thick, and has a distinct green or greenish-gray color. The sediments of this formation are medium dense to dense.

The River Bend Formation is comprised of fine sand, with lesser amounts of shell fragments and silt of the Oligocene age. This Formation lies 50 to 55 feet bgs at Site 43, and tends to be very dense.

HYDROGEOLOGY

There are several aquifers beneath Site 43 and vicinity. The upper two aquifers were investigated in this study, namely the surficial and Castle Hayne. The surficial aquifer, which is under unconfined conditions (i.e., water table aquifer), occurs within the sediments of the undifferentiated formation. The surficial aquifer typically lies within 5 feet of the surface, and is 30 to 37 feet thick in the vicinity of Site 43. The upper portion of the Castle Hayne aquifer lies within the sediments of the River Bend Formation. The Castle Hayne aquifer lies 50 to 55 feet bgs, and is approximately 200 feet thick in the vicinity of Camp Gieger and the Air Station (Cardinell et al., 1993). The Belgrade Formation, situated between the undifferentiated and River Bend Formations is also known as the Castle Hayne confining unit. The Castle Hayne confining unit is approximately 16 feet thick in the vicinity of Site 43.

The surficial aquifer hydraulic conductivity values are on the same order of magnitude as the value presented in the Cardinell (1993) report. The average hydraulic conductivity at Site 43, based on RI slug tests is 16.1 feet/day, compared to 50 feet/day presented by Cardinell. Cardinell provided an estimated hydraulic conductivity value of 50 feet/day based on a general composition of fine sand, mixed with some silt and clay. The average hydraulic conductivity and transmissivity for the Castle Hayne at Site 43 is 34.1 feet/day and 6,810 feet²/day, respectively. Cardinell's report presents hydraulic conductivities and transmissivities from several studies. Hydraulic conductivities range from 14 to 91 feet²/day and transmissivities range from 820 to 26,000 feet²/day. The RI results for Site 43 are comparable with other sites throughout Camp Lejeune.

The calculated groundwater flow velocities of the surficial varied by an order of magnitude across the site, ranging from 0.03 feet/day to 0.33 feet/day. The highest velocity observed is at 43-GW04. This is directly related to a hydraulic conductivity that is nearly an order of magnitude higher than the other wells.

The calculated groundwater flow velocities for the Castle Hayne were 1.19 feet/day at 43-GW01DW and 0.18 feet/day at 43-GW04DW. This order of magnitude difference is directly related to

hydraulic conductivity. Note that these velocities are an estimate due to the fact that only two points were used to calculate the groundwater gradient. Three points are desirable for determining the gradient.

Groundwater flow in the surficial aquifer at Site 43 is toward Strawhorn Creek and the marshland to the east, with an average velocity of 0.13 feet per day. Groundwater flow in the upper Castle Hayne aquifer is also to the east, with an average velocity of 0.69 feet/day. Because the hydraulic conductivity varies, groundwater may exhibit preferential flow paths following the relatively highly conductive medium and coarse sands.

The surficial and Castle Hayne aquifers underlying Site 43 are separated by the Castle Hayne confining unit. This confining unit consists of fine sand with lesser amounts of silt and clay, and is approximately 16 feet thick. There appears to be some degree of leakage between the two aquifers. A vertical hydraulic conductivity of 0.0004 feet/day was measured in a sample from the Castle Hayne confining unit on well 43-GW01DW. This rate suggests slow vertical infiltration through the confining unit at this particular location. The elevation trends between March and May in the surficial and Castle Hayne aquifers are similar, although the change in the Castle Hayne was less.

It appears that groundwater in the surficial aquifer at Site 43 discharges to the Strawhorn Creek. This is based on the elevation of the creek relative to groundwater elevations and groundwater flow direction. It appears that groundwater in the Castle Hayne aquifers flows underneath Strawhorn Creek, and may discharge to the New River and/or the adjacent marsh area. This is based on the groundwater flow direction and consistent gradient. Groundwater elevation data compiled and mapped by Cardinell indicate that groundwater in the Castle Hayne aquifer flows toward, and discharges to the New River and its major tributaries.

REMEDIAL INVESTIGATION ACTIVITIES

The field investigation program at OU No.6, Site 43, was initiated to detect and characterize potential impacts to human health and the environment resulting from past waste management activities. This section discusses the site-specific RI field investigation activities that were conducted to fulfill the objective. The RI field investigation of OU No. 6 commenced on February 20, 1995 and continued through May 10, 1995. The RI field program at Site 43 consisted of a site survey; a soil investigation, which included sampling and test pit excavations; a groundwater investigation, which included monitoring well installation, sampling, and aquifer testing; a surface water and sediment investigation; a habitat evaluation; and a bioassay study. The following sections detail the various investigation activities carried out during the RI.

A total of 18 borings were advanced to assess suspected waste disposal at Site 43; only one of those borings were utilized for the installation of a monitoring well. Five of the 18 boring locations were advanced within the Mounded Area, identified in the Final RI/FS Work Plan for OU No.6 (Baker, 1994b). A total of five soil test borings were completed at two separate locations identified as having partially buried containers. The remaining eight soil borings were completed at the various locations throughout the site shown.

A total of seven surface soil samples were also collected from an area immediately adjacent to monitoring well 43-GW01. Three surface soil samples (43-WA-SB01A, 43-WA-SB01B, AND 43-WA-SB01C) were collected in a semicircular pattern extending 15 feet to the north and east of soil

boring 43-WA-SB01. An additional four surface soil samples were later collected to more adequately assess the horizontal extent of contamination in the same area.

A total of five exploratory test pits were completed in conjunction with the soil investigation. Four of the five exploratory test pits were completed within or adjacent to the central cleared portion of Site 43; the fifth test pit was completed approximately 250 feet to the southeast of the other four. Test pits excavated into soil mounds revealed soil containing miscellaneous debris including metal straps, metal containers, bricks, and plastic. The materials are believed to be associated with the disposal of construction debris from the nearby housing area. Note that the debris were not containerized during the test pit operations because the materials unearthed remained within the trench and were not brought to the surface.

The analytical program initiated during the soil investigation at Site 43 focused on suspected contaminants of concern, as indicated by information regarding previous disposal practices and investigation results. Each of the 18 soil samples were analyzed for TAL inorganics and either TCL semivolatiles only or full TCL organics. In addition to the samples collected from soil test borings, seven surface soil samples were analyzed for TCL semivolatiles only. One composite soil sample was also collected for analysis of engineering parameters (i.e., particle size, and Atterberg limits). The engineering sample was comprised of individual grab samples collected from the ground surface to the water table. Samples were prepared and handled as described in the previous section.

Groundwater samples were collected from three existing shallow wells (43-GW01, 43-GW02, and 43-GW03), the newly installed shallow well (43-GW04), four temporary wells (43-TW01 through 43-TW04), and the two newly installed deep wells (43-GW01DW and 43-GW04DW) at Site 43. The groundwater sampling round was conducted at Site 43 in April of 1995.

Groundwater samples from three existing shallow wells, one newly installed shallow well, two newly installed deep wells, and four temporary wells were submitted for laboratory analysis from Site 43. Samples were analyzed for full TCL organics, TAL total metals, total suspended solids (TSS), and total dissolved solids (TDS). In addition, the groundwater sample obtained from 43-GW04DW was also analyzed for TAL dissolved metals. The groundwater samples were analyzed using Contract Laboratory Program (CLP) protocols and Level IV data quality.

A total of 6 surface water and 12 sediment samples were collected at Site 43 with each sampling station yielding one surface water and two sediment samples. Two of the sampling stations were located in Edwards Creek and four were located in Strawhorn creek, a tributary to Edwards Creek.

The analytical program at Site 43 was intended to assess the nature and extent of contamination in surface waters and sediments that may have resulted from past disposal practices. As a result, the analytical program focused on suspected contaminants of concern, based upon knowledge of suspected wastes and the overall quality of surface water and sediment. Both surface water and sediment samples were analyzed for full TCL organics and TAL metals. Surface water samples were also analyzed for TAL dissolved metals and hardness. In addition to organic and inorganic analyses, sediment samples were also analyzed for TOC and grain size.

A two-pronged ecological investigation, consisting of a habitat evaluation and a bioassay study, was conducted at Site 43. During the habitat evaluation, dominant vegetation types and species were identified in the field; those plants that could not be readily identified were collected for further examination in the office. Amphibians, reptiles, birds, and mammals were also identified as visual

sightings or evidence allowed. In many cases, the animals themselves were not seen, but scat, tracks, feeding areas, or remains were noted. From this information, ecological communities were established and biohabitat maps developed.

The bioassay study was conducted in a laboratory environment, using surface water and sediment samples that were retained from Site 43. A seven-day survival and growth study of fathead minnows was performed with each of the surface water samples. In addition to the surface water test, a 10-day survival and growth bioassay study was conducted using the sediments retained from Site 43.

EXTENT OF CONTAMINATION

This section presents a summary of analytical findings from field sampling activities conducted at Site 43. Table ES-1 provides a summary of site contamination for Site 43.

Soils

Positive detections of SVOCs in soil samples obtained at Site 43 are primarily limited to a cleared portion of the study area adjacent to the gravel access road. A total of 20 semivolatile contaminants, including 14 PAH compounds, were identified during the soil investigation at Site 43. The 14 PAH compounds were identified in both surface and subsurface soil samples. A majority of maximum semivolatile detections were observed in surface samples obtained from the first 12 inches below ground surface.

Based upon the results of analyses from seven surface and seven subsurface soil samples, the pesticides 4,4'-DDE and 4,4'-DDT appear to be scattered throughout the study area. The pesticide 4,4'-DDE was the most prevalent, with six positive detections ranging from 5.7 to 1,000 µg/kg. The highest pesticide concentration was that of 4,4'-DDD at 3,000 µg/kg. In general, higher concentrations of pesticides were observed in samples obtained from a small portion of the study area with partially buried containers.

Inorganic analytes were detected in both surface and subsurface soil samples throughout the study area. Chromium, lead, manganese, and zinc were each detected above twice their average base-specific background levels in more than 5 of the 20 surface soil samples. In general, higher concentrations of inorganic analytes were detected in soil samples obtained from two separate portions of the study area with partially metal buried containers.

Groundwater

Total metals were the most prevalent and widely distributed constituents in groundwater at Site 43. Concentrations of TAL total metals were generally higher in groundwater samples obtained from the shallow aquifer, rather than in samples obtained from the deeper aquifer. Iron and manganese were the most prevalent inorganic analytes, detected at concentrations that exceeded state standards.

A single positive detection of one organic compound, 4-methylphenol, was limited to a temporary monitoring well located in the northern portion of the study area. No other organic compounds were detected among groundwater samples obtained from the shallow and deep aquifers.

TABLE ES-1

**SUMMARY OF SITE CONTAMINATION
SITE 43, AGAN STREET DUMP
REMEDIAL INVESTIGATION, CTO-0303
MCAS, NEW RIVER, NORTH CAROLINA**

Media	Fraction	Detected Contaminants	Comparison Criteria		Site Contamination				
			Standard	Base Background	Min.	Max.	Max. Location	Detection Frequency	Distribution
Surface Soil	Volatiles	ND	NA	NA				0/7	
	Semivolatiles	4-Methylphenol	NA	NA	120	120	DA1-SB02	1/28	northeastern portion of site
		2-Methylnaphthalene	NA	NA	74	74	WA-SB01A	1/28	clearing adjacent to 43-GW01
		Acenaphthylene	NA	NA	71	71	WA-SB01A3	1/28	clearing adjacent to 43-GW01
		Acenaphthene (PAH)	NA	NA	45	2,100	WA-SB01A	3/28	clearing adjacent to 43-GW01
		Dibenzofuran	NA	NA	35	870	WA-SB01A	2/28	clearing adjacent to 43-GW01
		Fluorene (PAH)	NA	NA	53	1,700	WA-SB01A	3/28	clearing adjacent to 43-GW01
		Phenanthrene (PAH)	NA	NA	54	5,900	WA-SB01A	8/28	clearing adjacent to 43-GW01
		Anthracene (PAH)	NA	NA	44	820	WA-SB01A	3/28	clearing adjacent to 43-GW01
		Carbazole	NA	NA	99	350	WA-SB01A	5/28	clearing adjacent to 43-GW01
		Fluoranthene (PAH)	NA	NA	49	60,000	WA-SB01A	10/28	clearing adjacent to 43-GW01
		Pyrene (PAH)	NA	NA	49	64,000	WA-SB01A	10/28	clearing adjacent to 43-GW01
		Butylbenzylphthalate	NA	NA	50	420	OA-SB03	3/28	maximum northeast of clearing
		B(a)anthracene (PAH)	NA	NA	51	40,000	WA-SB01A	9/28	clearing adjacent to 43-GW01
		Chrysene (PAH)	NA	NA	110	46,000	WA-SB01A	9/28	clearing adjacent to 43-GW01
		B(b)fluoranthene (PAH)	NA	NA	44	52,000	WA-SB01A	10/28	clearing adjacent to 43-GW01
		B(k)fluoranthene (PAH)	NA	NA	57	20,000	WA-SB01A	9/28	clearing adjacent to 43-GW01
		Benzo(a)pyrene (PAH)	NA	NA	79	39,000	WA-SB01A	9/28	clearing adjacent to 43-GW01
		I(1,2,3-cd)pyrene (PAH)	NA	NA	42	27,000	WA-SB01A	10/28	clearing adjacent to 43-GW01
		D(a,h)anthracene (PAH)	NA	NA	47	1,200	WA-SB01A	8/28	clearing adjacent to 43-GW01
	B(g,h,i)perylene (PAH)	NA	NA	87	24,000	WA-SB01A	9/28	clearing adjacent to 43-GW01	

TABLE ES-1 (Continued)

SUMMARY OF SITE CONTAMINATION
 SITE 43, AGAN STREET DUMP
 REMEDIAL INVESTIGATION, CTO-0303
 MCAS, NEW RIVER, NORTH CAROLINA

Media	Fraction	Detected Contaminants	Comparison Criteria		Site Contamination				
			Standard	Base Background	Min.	Max.	Max. Location	Detection Frequency	Distribution
Surface Soil (Continued)	Pesticides	Heptachlor epoxide	NA	NA	2	2	WA-SB01A	1/7	clearing adjacent to 43-GW01
		4-4'-DDE	NA	NA	5.7	1,000	DA1-SB03	5/7	maximum northeast
		4-4'-DDD	NA	NA	3,000	3,000	DA1-SB03	1/7	northeastern portion of site
		4-4'-DDT	NA	NA	10	1,000	DA1-SB03	4/7	maximum northeast
		Endrin aldehyde	NA	NA	5.4	5.4	DA2-SB03	1/7	north of clearing
	PCBs	ND	NA	NA				0/7	
	Metals (1)	Cadmium	NA	0.7	0.74	1.70	WA-SB02	2/21	2 exceed BB, separate areas
		Chromium	NA	6.7	1.1	106	DA1-SB02	21/21	11 exceed BB, scattered
		Copper	NA	7.2	0.5	55.7	DA2-SB01	17/21	3 exceed BB, north of clearing
		Lead	NA	23.7	4.3	246	DA2-SB01	20/21	8 exceed BB, scattered
		Manganese	NA	18.5	2.8	189	DA2-SB01	21/21	5 exceed BB, scattered
		Mercury	NA	0.1	0.1	0.5	DA1-SB02	3/21	3 exceed BB, drum areas
		Nickel	NA	3.4	1.1	5	DA2-SB01	8/21	3 exceed BB, scattered
Zinc	NA	13.9	1.5	595	DA1-SB02	21/21	9 exceed BB, scattered		
Subsurface Soil	Volatiles	ND	NA	NA				0/7	
	Semivolatiles	Phenanthrene (PAH)	NA	NA	430	430	WA-SB02	1/20	clearing adjacent to 43-GW01
		Carbazole	NA	NA	73	73	WA-SB02	1/20	clearing adjacent to 43-GW01
		Fluoranthene (PAH)	NA	NA	850	850	WA-SB02	1/20	clearing adjacent to 43-GW01
		Pyrene (PAH)	NA	NA	1,800	1,800	WA-SB02	1/20	clearing adjacent to 43-GW01
		Butylbenzylphtalate	NA	NA	39	440	OA-SB03	2/20	north of clearing
		B(a)anthracene (PAH)	NA	NA	390	390	WA-SB02	1/20	clearing adjacent to 43-GW01
Chrysene (PAH)	NA	NA	740	740	WA-SB02	1/20	clearing adjacent to 43-GW01		

ES-7

TABLE ES-1 (Continued)

**SUMMARY OF SITE CONTAMINATION
SITE 43, AGAN STREET DUMP
REMEDIAL INVESTIGATION, CTO-0303
MCAS, NEW RIVER, NORTH CAROLINA**

Media	Fraction	Detected Contaminants	Comparison Criteria		Site Contamination				
			Standard	Base Background	Min.	Max.	Max. Location	Detection Frequency	Distribution
Subsurface Soil (Continued)	Semivolatiles (Continued)	B(b)fluoranthene (PAH)	NA	NA	780	780	WA-SB02	1/20	clearing adjacent to 43-GW01
		B(k)fluoranthene (PAH)	NA	NA	340	340	WA-SB02	1/20	clearing adjacent to 43-GW01
		Benzo(a)pyrene (PAH)	NA	NA	570	570	WA-SB02	1/20	clearing adjacent to 43-GW01
		I(1,2,3-cd)pyrene (PAH)	NA	NA	890	890	WA-SB02	1/20	clearing adjacent to 43-GW01
		B(g,h,i)perylene (PAH)	NA	NA	790	790	WA-SB02	1/20	clearing adjacent to 43-GW01
	Pesticides	4,4'-DDE	NA	NA	9	9	DA1-SB03	1/7	northeastern portion of site
		4,4'-DDD	NA	NA	1,200	1,200	DA1-SB03	1/7	northeastern portion of site
		4,4'-DDT	NA	NA	45	45	DA1-SB03	1/7	northeastern portion of site
	PCBs	ND	NA	NA				0/7	
	Metals (1)	Copper	NA	2.4	0.4	3.6	OA-SB01	6/20	1 exceeds BB, north of clearing
Groundwater	Volatiles	ND	NCWQS/MCL	NA				0/10	
	Semivolatiles	4-Methylphenol	NA	NA	2	2	43-TW04	1/10	north near SHC and EC
	Pesticides	ND	NCWQS/MCL	NA				0/10	
	PCBs	ND	NCWQS/MCL	NA				0/6	
	Total Metals	Iron	NCWQS - 300	NA	109	33,800	43-TW04	10/10	8 exceed standard, scattered
		Manganese	NCWQS - 50	NA	4.4	107	43-TW04	10/10	2 exceed standard, central and north
Surface Water (2)	Volatiles	1,2-Dichloroethene (total)	NCWQS - 7.0	NA	2	2	EC-SW02	2/6	neither exceed standard, EC
	Semivolatiles	ND	NCWQS/NOAA	NA				0/6	
	Pesticides	4,4'-DDE	WQS - 0.00059	NA	0.1	0.1	EC-SW01	2/6	both exceed standard, 1 EC, 1 SHC
		4,4'-DDD	WQS - 0.00084	NA	0.1	0.6	EC-SW01	3/6	3 exceed standard, 1 EC, 2 SHC
	PCBs	ND	NCWQS/NOAA	NA				0/6	
	Metals (3)	Copper	NCWQS - 3	129	1.8	3.2	EC-SW02	3/6	1 exceeds standard, not BB
Sediment	Volatiles	Carbon Disulfide	NA	NA	3	26	EC-SD02	3/12	2 from EC and 1 from SHC
	Semivolatiles	4-Methylphenol	NA	NA	210	210	SHC-SD03	1/12	adjacent to study area, SHC
		Pyrene (PAH)	NOAA - 350	NA	200	200	EC-SD02	1/12	does not exceed standard, EC
		Benzo(a)pyrene (PAH)	NOAA - 400	NA	290	1,900	SHC-SD02	4/12	3 exceed standard, 2 EC and 1 SHC

TABLE ES-1 (Continued)

**SUMMARY OF SITE CONTAMINATION
SITE 43, AGAN STREET DUMP
REMEDIAL INVESTIGATION, CTO-0303
MCAS, NEW RIVER, NORTH CAROLINA**

Media	Fraction	Detected Contaminants	Comparison Criteria		Site Contamination				
			Standard	Base Background	Min.	Max.	Max. Location	Detection Frequency	Distribution
Sediment (Continued)	Pesticides	4,4'-DDE	NOAA - 2	NA	12	8,900	SHC-SD04	10/12	10 exceed standard, scattered
		Endrin	NA	NA	12	16	EC-SD01	2/11	1 detection EC and 1 SHC
		4,4'-DDD	NOAA - 2	NA	5.6	37,000	SHC-SD04	11/12	11 exceed standard, scattered
		4,4'-DDT	NOAA - 1	NA	9.3	180	EC-SD01	6/12	6 exceed standard, scattered
		alpha-Chlordane	NOAA - 0.5	NA	7.2	49	SHC-SD03	8/12	8 exceed standard, scattered
		gamma-Chlordane	NOAA - 0.5	NA	9.6	74	SHC-SD03	9/12	9 exceed standard, scattered
	PCBs	ND	NOAA	NA				0/9	
	Metals (3)	Lead	NOAA - 35	314	6.1	206	SHC-SD03	12/12	7 exceed standard, none exceed BB
		Mercury	NOAA - 0.15	ND	0.4	0.7	EC-SD01	2/12	2 exceed standard
		Silver	NOAA - 1	7.3	1.9	2.8	EC-SD02	2/12	2 exceed standard, niether exceed BB
Zinc		NOAA - 120	926	1.5	338	EC-SD01	12/12	4 exceed standard, none exceed BB	

Notes:

- Concentrations are presented in $\mu\text{g/L}$ for liquid and $\mu\text{g/Kg}$ for solids (ppb), metal concentrations for soils and sediments are presented in mg/Kg (ppm).
 - (1) Metals in both surface and subsurface soils were compared to twice the average base background positive concentrations for priority pollutant metals only (i.e., antimony, arsenic, beryllium, cadmium, chromium, copper, lead, mercury, nickel, selenium, silver, thallium, zinc).
 - (2) Positive contaminant detections in surface water were compared to appropriate NCWQS and NOAA saltwater screening values.
 - (3) Total metals in surface water and sediment were also compared to the maximum positive detections in upgradient samples at MCB, Camp Lejeune.
- BB - Base background, value equals two times average value for soil and the maximum value for surface water and sediment (refer to Appendix P)
- BEHP - bis(2-ethylhexyl)phthalate
- EC - Edwards Creek
- NA - Not applicable
- NCWQS - North Carolina Water Quality Standard
- ND - Not detected
- NOAA - National Oceanic and Atmospheric Administration
- MCL - Federal Maximum Contaminant Level
- PAH - Polynuclear aromatic hydrocarbon
- SHC - Strawhorn Creek

Surface Water

Edwards Creek

A positive detection of one volatile organic compound was observed among the two surface water samples obtained from Edwards Creek. The VOC 1,2-dichloroethene was detected at a concentration of 2 µg/L in samples EC-SW01 and EC-SW02, located along the northern-most portion of the study area. The pesticides 4,4'-DDE and 4,4'-DDD were detected at trace concentrations of 0.097 and 0.64 µg/L in sample EC-SW01. Applicable screening values for 4,4'-DDE and 4,4'-DDD are 0.00059 and 0.00084 µg/L. As provided in Table ES-1, both detections represent an exceedence of the applicable screening values. No other pesticide compounds were detected among the two surface water samples obtained from Edwards Creek.

Twelve of 23 TAL total metals were positively identified among the surface water samples obtained from Edwards Creek (antimony, beryllium, cadmium, chromium, cobalt, mercury, nickel, selenium, silver, thallium, and zinc were not detected). Positive detections of metals were compared to screening values for surface water bodies classified as saltwater (i.e., containing greater than five percent saltwater). Copper was the only TAL total metal detected among surface water samples at a concentration which exceeded an applicable screening value. Copper was detected at a concentration of 3.2 µg/L in the surface water sample obtained from station EC-SW02. The NCWQS for copper in tidally influenced surface water bodies is 3 µg/L. Although the positive copper detection slightly exceeded the screening value, it did not exceed the range of base-specific background concentrations (refer to Appendix P). No other total metal concentrations among surface water samples exceeded state or federal screening values.

Strawhorn Creek

Positive detections of two pesticide compounds were observed among the four surface water samples obtained from Strawhorn Creek. The pesticide 4,4'-DDD was detected in samples obtained from stations SHC-SW03 and SHC-SW04 at concentrations of 0.23 and 0.12 µg/L, respectively. Both 4,4'-DDD detections exceeded the 0.00084 µg/L screening value. At sampling location SHC-SW04, 4,4'-DDE was detected at a concentration of 0.095 µg/L. Both detections of 4,4'-DDD exceeded the applicable screening value of 0.00059 µg/L. The two sampling locations are situated approximately 350 and 700 feet upstream of the Edwards Creek and Strawhorn Creek confluence. No other pesticides were detected among surface water samples submitted for laboratory analysis from Site 43.

Laboratory analyses of four surface water samples obtained from Strawhorn Creek indicate that 12 of 23 possible total metals were positively detected. None of the total metal concentrations in the four surface water samples obtained from Strawhorn Creek exceeded state or federal screening values.

Sediments

Edwards Creek

Carbon disulfide was the only VOC detected among the four sediment samples obtained from Edwards Creek. As provided in Table ES-1, carbon disulfide was identified at a concentrations of

20 and 26 µg/kg in a samples obtained from stations EC-SD01 and EC-SD02. No other VOC was detected among sediment samples from Edwards Creek.

One SVOC was detected in three of the four sediment samples obtained from Edwards Creek. As provided in Table ES-1, benzo(a)pyrene was detected in two of the four sediment samples at concentrations of 650 and 1,400 µg/kg. The two benzo(a)pyrene detections, observed at both Edwards Creek sampling stations, exceeded the NOAA Effects Range-Low (ER-L) screening value of 400 µg/kg. Pyrene was detected in one of the four sediment samples at a concentration of 200 µg/kg, which did not exceed the 350 µg/kg screening value. Both benzo(a)pyrene and pyrene are PAH compounds. No other SVOCs were detected in the sediment samples obtained from Edwards Creek.

The pesticide 4,4'-DDD was detected in each of the four sediment samples obtained from Edwards Creek. As indicted in Table ES-1, the pesticides 4,4'-DDE, endrin, 4,4'-DDT, alpha-chlordane, and gamma-chlordane were also detected at least once among the four sediment samples. The maximum pesticide concentration, 4,4'-DDD at 8,500 µg/kg, was detected at sampling station EC-SD01. Each positive detection for five of the six identified pesticides exceeded applicable screening values; there are no screening values for endrin. The pesticides 4,4'-DDE, endrin, 4,4'-DDT, alpha-chlordane, and gamma-chlordane were detected at maximum concentrations of 1,600, 16, 180, 21, and 31 µg/kg, respectively. No other pesticide compounds were detected among sediment samples obtained from Edwards Creek.

Twenty of 23 TAL total metals were positively identified among the four Edwards Creek sediment samples (antimony, beryllium, and thallium were not detected). Lead, mercury, silver, and zinc were identified at concentrations in excess of their respective NOAA ER-L screening values. As provided in Table ES-1, lead, mercury, and zinc were each detected in excess of sediment screening values within two of the four samples obtained from Edwards Creek. Silver was detected once among the four samples at a concentration of 2.8 µg/kg, which exceeded the 1.0 µg/kg screening value. Lead, mercury, and zinc were each detected at their respective maximum concentrations among the four Edwards Creek sediment samples at station EC-SD01. Lead and zinc were detected at maximum concentrations of 180 and 338 µg/kg. The NOAA ER-L screening values for lead and zinc are 35 and 120 µg/kg, respectively. However, none of the lead, silver, or zinc concentrations exceeded base-specific background metal concentrations. Concentrations of mercury in samples EC-SD01 (0.66 µg/kg) and EC-SD02 (0.44 µg/kg) slightly exceeded the screening value of 0.15 µg/kg. No other total metal concentrations among the four Edwards Creek sediment samples exceeded applicable screening values.

Strawhorn Creek

Carbon disulfide was the only volatile organic compound detected among the eight sediment samples obtained from Strawhorn Creek. Carbon disulfide was detected at a concentration of 3 µg/kg in a sample obtained from station SHC-SD01. Sampling station SHC-SD01 is located slightly upgradient of the suspected disposal area at Site 43.

Two semivolatile compounds were identified in sediment samples obtained from Strawhorn Creek. 4-Methylphenol and benzo(a)pyrene were positively identified in one and two of the eight sediment samples, respectively. No semivolatile compounds were detected at location SHC-SD01, located slightly upstream of the suspected disposal area. The maximum semivolatile concentration among sediment samples obtained from the Strawhorn Creek was that of benzo(a)pyrene at 1,900 µg/kg.

This benzo(a)pyrene detection from sampling station SHC-SD02 exceeded the NOAA ER-L screening value of 400 µg/kg. The SVOC 4-methylphenol was detected at a maximum concentration of 210 µg/kg in sample SHC-SD03. No other SVOCs were detected among sediment samples obtained from Strawhorn Creek.

The pesticides 4,4'-DDE, endrin, 4,4'-DDD, 4,4'-DDT, alpha-chlordane, and gamma-chlordane were detected among the eight sediment samples obtained from Strawhorn Creek. 4,4'-DDE and 4,4'-DDD were detected most frequently among organic compounds in sediment. Both 4,4'-DDE and 4,4'-DDD were detected in seven of the eight samples, at maximum concentrations of 8,900 and 37,000 µg/kg in a sample obtained from station SHC-SD04. The pesticide 4,4'-DDT was detected in four of the eight samples with a maximum concentration of 65 µg/kg also in sample SHC-SD04. Alpha-chlordane and gamma-chlordane were detected in six of the eight samples at maximum concentrations of 49 and 74 µg/kg. Endrin was detected once among Strawhorn Creek sediment samples at a concentration of 12 µg/kg. Excluding endrin, each pesticide detection in sediment samples obtained from Strawhorn Creek exceeded applicable NOAA ER-L screening values.

Nineteen of 23 TAL total metals were positively identified among the 8 sediment samples obtained from Strawhorn Creek (antimony, cadmium, mercury, and thallium were not detected). Of the nineteen inorganics detected, lead, silver, and zinc were identified at concentrations in excess of applicable NOAA ER-L screening values. Lead was detected in five of the six sediment samples obtained from Strawhorn Creek at concentrations in excess of the 35 µg/kg screening value. The maximum lead concentration, 206 µg/kg, was detected at sampling location SHC-SD03. Silver and zinc were detected in excess of sediment screening values in one and two of the eight Strawhorn Creek sediment samples, respectively. The silver concentration of 1.9 µg/kg in sample SHC-SD03 exceeded the NOAA screening value of 1.0 µg/kg. Zinc was detected twice at concentrations of 223 and 254 µg/kg which exceeded the 120 µg/kg screening value. No other total metal concentrations among the eight Strawhorn Creek sediment samples exceeded screening values. Lead, silver, and zinc were detected at concentrations within base-specific background levels.

HUMAN HEALTH RISK ASSESSMENT

At Site 43, exposure to surface soil, surface water and sediment was assessed for the current receptors. Surface soil, groundwater, surface water, and sediment exposure were evaluated for the future residents. Subsurface soil exposure was evaluated for the future construction worker.

In the current case, the following receptors were assessed: military personnel and adult and child trespassers. Receptor exposure to surface soil, surface water, sediment was examined. The risks calculated for all exposure pathways and receptors were within acceptable risk ranges.

In the future case, child and adult residents were assessed for potential exposure to groundwater, surface soil, surface water, and sediment. A construction worker was evaluated for subsurface soil exposure. The potential noncarcinogenic and carcinogenic risks for the construction worker at Site 43 were with acceptable levels. The noncarcinogenic risk from groundwater ingestion for the future child resident was 8.9. The noncarcinogenic risk from groundwater ingestion for the future adult resident was 3.9. These values exceed the acceptable risk value of one.

The iron constitutes 82% of both elevated risk values, while aluminum contributes 18%. Without iron as a COPC, the noncarcinogenic risk values for future residential adults and children would be 0.69 and 1.6, respectively. The studies that prompted the addition of a RBC value for iron are

provisional only and have not undergone formal review by the USEPA. Also, iron is considered an essential nutrient.

Finally, it should be noted that groundwater in the MCB Camp Lejeune area is naturally rich in iron. In addition, there is no record of any historical use of iron or aluminum at Site 43 although buried construction debris is scattered throughout the site. It is not likely, however, that these analytes are leaching out of this debris given the fact that the pH of the soils and groundwater are not acidic enough to leach metals. Consequently, it is assumed that iron and aluminum are naturally occurring inorganic analytes in groundwater, and their presence is not attributable to site operations.

ECOLOGICAL RISK ASSESSMENT

Aquatic Ecosystem

As presented earlier in the ERA, the assessment endpoints for the aquatic receptors are potential decreases in the survival, growth, and/or reproduction of the aquatic receptor population or subpopulation that is attributable to site-related contaminants. These assessment endpoints are evaluated using a series of measurement endpoints. This section of the ERA examines each of the measurement endpoints to determine if the assessment endpoints are impacted.

The first measurement endpoint is decreased survival and growth of *P. promelas* and *C. tentans*, decreased survival and reproduction of *C. dubia*, and decreased survival of *H. azteca*, all as compared to controls. The bioassay samples were collected at station 43-SHC-SW/SD04 in an area of the highest pesticide concentrations in the sediment, and a relatively high pesticide concentration in the surface water. Concentrations of manganese slightly exceeded the SWSVs at this station. For the surface water bioassay, adverse survival and reproductive effects were observed in the *C. dubia* bioassay. However, no adverse survival or growth effects were observed in the fathead minnow bioassay. It was reported in a personal communication with Region IV USEPA, that salinities above 2 parts per thousand (ppt) cause reproductive effects in the *C. dubia* and that it has an LC50 of 8 ppt salinity. Therefore, it is likely that at least part of the adverse effects in the surface water sample collected at Site 43 were due to the salinity (which ranged from 5 to 6 ppt), the pesticides and/or manganese. The fathead minnow is not as sensitive to salinity as the *C. dubia*. For the sediment bioassay, decreased survival of *H. azteca* was observed in the Site 43 sample. However, no decrease in survival or growth of *C. tentans* was observed in the Site 43 sample. The high pesticide concentrations in the sediment may be causing the decrease in survival of *H. azteca*.

The second measurement endpoint is determining if the contaminant concentrations in the surface water and sediment exceed the contaminant-specific surface water and sediment effect concentrations (i.e., SWSVs, and SSVs). Several metals, SVOCs, and pesticides were detected in the surface water and/or sediment at concentrations above the SWSVs or SSVs. Based on the screening value comparison, there is a high potential for a decrease in the population of aquatic receptors from pesticides in the surface water and sediment. There is only a low potential for a decrease in the population of aquatic receptors from metals in the surface water and sediment and SVOCs in the sediment, since the concentration of these contaminants only slightly exceeded the screening values. The source of the pesticides is not known since pesticides reportedly were not stored or disposed at Site 43. The pesticides may be associated with the base-wide spraying that occurred in the past.

Terrestrial Ecosystem

As presented earlier in the ERA, the assessment endpoints for the terrestrial receptors is the potential reduction of a receptor population or subpopulation that is attributable to contaminants from the site. This section evaluates this assessment endpoint using the measurement endpoints.

The first measurement endpoint is determining if there is an exceedance of contaminant-specific soil effect concentrations (i.e., SSSVs). Several SVOCs, pesticides, and metals were detected in the surface soil at concentrations that exceed the SSSVs. Much of the study area at Site 43 is heavily vegetated with dense understory and trees greater than three inches in diameter. Therefore, ecological receptors have a high potential for becoming exposed to contaminants in the surface soil.

The second measurement endpoint is determining if the terrestrial CDI exceeds the TRVs. The bobwhite quail, cottontail rabbit and the raccoon are the only terrestrial species with estimated CDI values that exceeded the TRV values. The individual COPCs QIs are relatively low (with the exception of aluminum in the raccoon model), indicating that risk to terrestrial species from these contaminants is expected to be low. The actual risk to the raccoon from aluminum is expected to be low, based on the conservative assumption in the model that the raccoon will eat all of its fish from Site 43.

Overall, some potential impacts to soil invertebrates and plants may occur as a result of site-related contaminants. It should be noted that there is much uncertainty in the SSSVs. A potential decrease in the terrestrial vertebrate population from site-related contaminants is not expected based on the terrestrial intake model.

1.0 INTRODUCTION

Marine Corps Base (MCB), Camp Lejeune was placed on the Comprehensive Environmental Response, Compensation, and Liability Act (CERCLA) National Priorities List (NPL) on October 4, 1989 (54 Federal Register 41015, October 4, 1989). Subsequent to this listing, the United States Environmental Protection Agency (USEPA) Region IV; the North Carolina Department of Environment, Health and Natural Resources (NC DEHNR); and the United States Department of the Navy (DoN) entered into a Federal Facilities Agreement (FFA) for MCB, Camp Lejeune. The FFA ensures that environmental impacts associated with past and present activities at MCB, Camp Lejeune are thoroughly investigated and appropriate CERCLA response/Resource Conservation and Recovery Act (RCRA) corrective action alternatives are developed and implemented, as necessary, to protect public health, welfare, and the environment (FFA, 1989).

The Fiscal Year 1996 Site Management Plan for MCB, Camp Lejeune, the primary document referenced in the FFA, identifies 33 sites that require Remedial Investigation/Feasibility Study (RI/FS) activities. These 33 sites have been divided into 16 operable units to simplify RI/FS activities. An RI was conducted at Operable Unit (OU) No. 6, Sites 36, 43, 44, 54, and 86, during February through May of 1995. This report describes the RI conducted at Site 43, the Agan Street Dump. Four additional reports have been prepared that address each of the other OU No. 6 sites. Figure 1-1 depicts the location of the five sites that comprise OU No. 6. [Note that all tables and figures are presented in the back of each section.]

The purpose of an RI is to evaluate the nature and extent of the threat to public health and the environment caused by the release or threatened release of hazardous substances, pollutants, or contaminants. This RI investigation was conducted through the sampling of several environmental media (soil, groundwater, surface water, sediment, and fish tissue) at OU No. 6, evaluating the resultant analytical data, and performing a human health risk assessment (RA) and ecological RA. This RI report contains the results of all field investigations, the human health RA, and the ecological RA. Furthermore, the RI report provides information to support the FS and Record of Decision (ROD) documents.

This RI Report has been prepared by Baker Environmental, Inc. (Baker) and submitted to the USEPA Region IV; the NC DEHNR; MCB, Camp Lejeune Environmental Management Department (EMD); the Navy Environmental Health Center (NEHC); the Agency for Toxic Substances and Disease Registry; and to the Naval Facilities Engineering Command, Atlantic Division (LANTDIV) for their review.

The following subsections describe the arrangement of OU No. 6 and the background and setting of both MCB, Camp Lejeune and Site 43. In addition, Section 1.1 provides an overview of the RI report's organization.

1.1 Report Organization

This RI Report is comprised of one text volume with appendices provided in an additional volume. The following section headings are included within this text volume and provide site-specific investigation findings:

- Study Area Investigation - Section 2.0
- Site Physical Characteristics - Section 3.0
- Nature and Extent of Contamination - Section 4.0
- Contaminant Fate and Transport - Section 5.0
- Baseline Human Health Risk Assessment - Section 6.0
- Ecological Risk Assessment - Section 7.0
- Conclusions - Section 8.0

1.2 Background and Setting of MCB, Camp Lejeune

This section summarizes existing background and setting information pertaining to MCB, Camp Lejeune. The text specifically addresses the location and setting of MCB, Camp Lejeune, its history, topography, geology, hydrogeology, climatology, ecology, land use, and demography.

1.2.1 Location and Setting

MCB, Camp Lejeune is located on the coastal plain of North Carolina in Onslow County. The facility encompasses approximately 234 square miles and is bisected by the New River. The New River flows in a southeasterly direction and forms a large estuary before entering the Atlantic Ocean. The southeastern border of MCB, Camp Lejeune is the Atlantic Ocean shoreline. The western and northeastern boundaries of the facility are U.S. Route 17 and State Route 24, respectively. The City of Jacksonville borders MCB, Camp Lejeune to the north (refer to Figure 1-1).

1.2.2 History

Construction of MCB, Camp Lejeune began in April 1941 at the Hadnot Point Industrial Area (HPIA), where major functions of the base are located today. The facility was designed to be the "World's Most Complete Amphibious Training Base." The MCB, Camp Lejeune complex consists of five geographical locations under the jurisdiction of the Base Command. These areas include Camp Geiger, Montford Point, Courthouse Bay, Mainside, and the Rifle Range Area. Site 36 is located within the Camp Geiger operations area. The remaining four sites that comprise OU No. 6, Sites 43, 44, 54, and 86, are located within the Marine Corps Air Station (MCAS), New River operations area. Although MCAS, New River is under the jurisdiction of a separate command (i.e., MCAS, Cherry Point), environmental compliance issues and Installation Restoration Program (IRP) sites are the responsibility of MCB, Camp Lejeune EMD.

1.2.3 Operable Unit Description

Operable units are formed as an incremental step toward addressing individual site concerns. There are currently 33 Installation Restoration Program (IRP) sites at MCB, Camp Lejeune, which have been grouped into 16 operable units. Due to the similar nature of suspected waste and their close proximity to one another, Sites 36, 43, 44, 54, and 86 were grouped together as OU No. 6. Figure 1-2 depicts the locations of all 16 operable units at MCB, Camp Lejeune.

OU No. 6 is located within the northwest portion of the facility, to the south and east of Camp Geiger Development Area. Site 36 is referred to as the "Camp Geiger Area Dump," Site 43 is the "Agan Street Dump," Site 44 is known as the "Jones Street Dump," Site 54 is the "Crash Crew Fire Training Burn Pit," and Site 86 is known as the "Above Ground Storage Tank Area."

1.2.4 Topography

The flat topography of MCB, Camp Lejeune is typical of seaward portions of the North Carolina coastal plain. Elevations on the base vary from sea level to 72 feet above mean sea level (msl); however, most of MCB, Camp Lejeune is between 20 and 40 feet above msl.

Drainage at MCB, Camp Lejeune is generally toward the New River, except in areas near the coast where flow is into the Intracoastal Waterway that lies between the mainland and barrier islands. In developed areas of the facility, natural drainage has been altered by asphalt cover, storm sewers, and drainage ditches. Approximately 70 percent of MCB, Camp Lejeune is comprised of broad, flat interstream areas with poor drainage (WAR, 1983).

1.2.5 Surface Water Hydrology

The dominant surface water feature at MCB, Camp Lejeune is the New River. It receives drainage from a majority of the base. The New River is short with a course of approximately 50 miles on the central Coastal Plain of North Carolina. Over most of its length, the New River is confined to a relatively narrow channel in Eocene and Oligocene limestones. South of Jacksonville, the river widens dramatically as it flows across less resistant sands, clays, and marls. At MCB, Camp Lejeune, the New River flows in a southerly direction into the Atlantic Ocean through the New River Inlet. Several small coastal creeks drain the area of MCB, Camp Lejeune not associated with the New River and its tributaries. These creeks flow into the Intracoastal Waterway, which is connected to the Atlantic Ocean by Bear Inlet, Brown's Inlet, and the New River Inlet. The New River, the Intracoastal Waterway, and the Atlantic Ocean converge at the New River Inlet.

Water quality criteria for surface waters in North Carolina have been published under Title 15 of the North Carolina Administrative Code. At MCB, Camp Lejeune, the New River falls into two classifications: SC (estuarine waters not suited for body-contact sports or commercial shellfishing); and SA (estuarine waters suited for commercial shellfishing). The SC classification applies to only three areas of the New River at MCB, Camp Lejeune; the rest of the New River at MCB, Camp Lejeune falls into the SA classification (ESE, 1990).

1.2.6 Geology

MCB, Camp Lejeune is located within the Atlantic Coastal Plain physiographic province. The sediments of this province consist primarily of sand, silt, and clay. Other sediments may be present, including shell beds and gravel. Sediments may be of marine or continental origin. These sediments are found in interfingering beds and lenses that gently dip and thicken to the southeast. Sediments of this type range in age from early Cretaceous to Quaternary time and overlie igneous and metamorphic rocks of pre-Cretaceous age. Table 1-1 presents a generalized stratigraphic column for the Atlantic Coastal Plain of North Carolina (Harned et al., 1989).

United States Geological Survey (USGS) studies at MCB, Camp Lejeune indicate that the base is underlain by sand, silt, clay, calcareous clay and partially cemented limestone. The combined thickness of these sediments beneath the base is approximately 1,500 feet.

1.2.7 Hydrogeology

The aquifers of primary interest are the surficial aquifer and the aquifer immediately below it, the Castle Hayne Aquifer. Other aquifers that occur beneath the facility include the Beaufort, Peedee, Black Creek, and upper and lower Cape Fear aquifers. The following summary is a compilation of information which pertains to aquifer characteristics within the MCB, Camp Lejeune area. A generalized hydrogeologic cross-section illustrating the relationship between the aquifers in this area is presented in Figures 1-3 and 1-4.

The surficial aquifer consists of interfingering beds of sand, clay, sandy clay, and silt that contain some peat and shells. The thickness of the surficial aquifer ranges from 0 to 73 feet and averages nearly 25 feet over the MCB, Camp Lejeune area. It is generally thickest in the interstream divide areas and presumed absent where it is cut by the New River and its tributaries. The beds are thin and discontinuous, and have limited lateral continuity. This aquifer is not used for water supply at MCB, Camp Lejeune.

The general lithology of the surficial aquifer and the absence of any thick, continuous clay beds are indications of relatively high vertical conductivity within the aquifer. The estimated lateral hydraulic conductivity of the surficial aquifer in the MCB, Camp Lejeune area is 50 feet per day, and is based on a general composition of fine sand mixed with some silt and clay (Harned et al., 1989). However, data from a number of slug tests conducted by Baker at sites near OU No. 6 indicate much lower lateral hydraulic conductivity values. These values range from 7.2×10^{-4} feet per day to 6.4 feet per day. Table 1-2 presents a summary of hydraulic properties compiled during investigations at other sites located within the developed portion of MCAS, New River.

Between the surficial and the Castle Hayne aquifers lies the Castle Hayne confining unit. This unit consists of clay, silt, and sandy clay beds. In general, the Castle Hayne confining unit may be characterized as a group of less permeable beds at the top of the Castle Hayne aquifer that have been partly eroded or incised in places. The Castle Hayne confining unit is discontinuous, and has a thickness ranging from 0 to 26 feet, averaging about 9 feet where present. There is no discernable trend in the thickness of the confining unit seen in these or related investigations, nor is there any information in the USGS literature regarding any trend of the depth of the confining unit.

Previously recorded data indicate that vertical hydraulic conductivity of the confining unit ranged from 0.0014 to 0.41 feet per day (Cardinell et al., 1993). Data obtained from a pump test conducted by ESE indicated a vertical hydraulic conductivity for this unit ranging from 1.4×10^{-3} to 5.1×10^{-2} feet per day (ESE, 1988). Based on the moderate conductivity values and the thin, discontinuous nature of the confining unit, this unit may only be partly effective in retarding the downward vertical movement of groundwater from the surficial aquifer.

The Castle Hayne aquifer lies below the surficial aquifer and consists primarily of unconsolidated sand, shell fragments, and fossiliferous limestone. Clay, silt, silty and sandy clay, and indurated limestone also occur within the aquifer. The upper part of the aquifer consists primarily of calcareous sand with some continuous and discontinuous thin clay and silt beds. The calcareous sand becomes more limy with depth. The lower part of the aquifer consists of consolidated or poorly consolidated limestone and sandy limestone interbedded with clay and sand.

The Castle Hayne aquifer is about 150 to 350 feet thick, increasing in thickness toward the ocean. The top of the aquifer lies approximately 20 to 73 feet below the ground surface. The top of the

aquifer dips southward and is deepest near the Atlantic coast, east of the New River. The top of the aquifer also forms a basin in the vicinity of Paradise Point. Estimates of hydraulic conductivity indicate a wide variation in range, from 14 to 91 feet per day. Table 1-3 presents estimates of the Castle Hayne aquifer and confining unit hydraulic properties in the vicinity of MCB, Camp Lejeune.

Onslow County and MCB, Camp Lejeune lie in an area where the Castle Hayne aquifer generally contains freshwater; however, the proximity of saltwater in deeper layers just below the aquifer and in the New River estuary is of concern in managing water withdrawals. Over-pumping of the deeper parts of the aquifer could cause encroachment of saltwater. The aquifer generally contains water having less than 250 milligrams per liter (mg/L) chloride throughout the base, except for one USGS well in the southern portion of the base that is screened in the lower portion of the aquifer. Chloride was measured at 960 mg/L in a sample collected in 1989 from this well.

Rainfall in the MCB, Camp Lejeune area enters the ground in recharge areas, infiltrates the soil, and moves downward until it reaches the surficial aquifer. Recharge areas at Camp Lejeune are mainly comprised of interstream areas. In the surficial aquifer, groundwater flows in the direction of lower hydraulic head until it reaches discharge points or fronts. These discharge areas include the New River and its tributaries and the ocean. Though most of the rainfall entering the surficial aquifer discharges to local streams, a relatively small amount infiltrates to the Castle Hayne. The surficial aquifer supplies the primary recharge to the Castle Hayne aquifer. Like the surficial aquifer, the Castle Hayne naturally discharges to the New River and major tributaries; however, pumping of the Castle Hayne may locally influence flow directions.

The potentiometric surface of the surficial aquifer varies seasonally, as seen through the observation of water levels in monitoring wells. The surficial aquifer receives more recharge in the winter than in the summer when much of the water evaporates or is transpired by plants before it can reach the water table. As a result, the potentiometric surface is generally highest in the winter months and lowest in the summer or early fall.

Water levels from wells placed in deeper aquifers, such as the Castle Hayne, were also used to establish potentiometric surfaces. Because the Castle Hayne is at least partially confined from the surficial aquifer and is not influenced by rainfall as strongly as the surficial aquifer, the seasonal variations tend to be slower and smaller than in surficial aquifer.

1.2.8 Ecology

The ecology at MCB Camp Lejeune is discussed in three sections that include ecological communities, sensitive environments and threatened and endangered species.

1.2.8.1 Ecological Communities

MCB, Camp Lejeune is located on North Carolina's coastal plain. A number of natural ecological communities are present within this region. In addition, variations of natural communities have occurred in response to disturbance and intervention (e.g., forest clearing, urbanization). The natural communities found in the area are summarized as follows:

- Mixed Hardwood Forest - Found generally on slopes of ravines. Beech, white oak, tulip, sweetgum, and holly are indicator species.

- Southeastern Evergreen Forest - Dominated by pines, especially longleaf pine.
- Loblolly Pine/Hardwoods Community - Second growth forest that includes loblolly pine with a mix of hardwoods (i.e., oak, hickory, sweetgum, sour gum, red maple, and holly).
- Southern Floodplain Forest - Occurs on the floodplains of rivers. Hardwoods dominate with a variety of species present. Composition of species varies with the amount of moisture.
- Maritime Forest - Develops on the lee side of stable sand dunes protected from the ocean. Live oak is an indicator species along with pine, cedar, yaupon, holly, and laurel oak. Deciduous hardwoods may be present where forest is mature.
- Pocosins - Lowland forest community that develops on highly organic soils that are seasonally flooded. Characterized by plants adapted to drought and acidic soils low in nutrients. Pond pine is the dominant tree with dense layer of evergreen shrubs. Strongly influenced by fire.
- Cypress Tupelo Swamp Forest - Occurs in the lowest and wettest areas of floodplains. Dominated by bald cypress and tupelo.
- Freshwater Marsh - Occurs upstream from tidal marshes and downstream from non-tidal freshwater wetlands. Cattails, sedges, and rushes are present.
- Salt Marsh - Regularly flooded, tidally influenced areas dominated by salt-tolerant grasses. Saltwater cordgrass is a characteristic species. Tidal mud flats may be present during low tide.
- Salt Shrub Thicket - High areas of salt marshes and beach areas behind dunes. Subjected to salt spray and periodic saltwater flooding. Dominated by salt resistant shrubs.
- Dunes/Beaches - Zones from the ocean shore to the maritime forest. Subjected to sand, salt, wind, and water.
- Ponds and Lakes - Low depressional areas where water table reaches the surface or where ground is impermeable. In ponds rooted plants can grow across the bottom. Fish populations in these ponds include redeer, bluegill, largemouth bass, and channel catfish.
- Open Water - Marine and estuarine waters as well as all underlying bottoms below the intertidal zone.

MCB, Camp Lejeune covers approximately 150,000 acres or 234 square miles. Marine and estuarine open water account for 26,000 acres and terrestrial and palustrine land account for 85,000 acres. Forests are predominant as terrestrial cover and pine forest is the dominant habitat type. A total of 21,000 acres of the pine forest is loblolly pine, 7700 acres are dominated by longleaf pine

forest, and 3600 acres are dominated by pond pine forest. These pine forests include natural subcommunities that are maintained by fire.

In addition to the pine forest, mixed pine\hardwood forest is present on MCB, Camp Lejeune and accounts for 15,900 acres. An additional 12,100 acres are covered by hardwood forest. Of the wetlands present, estuarine marsh accounts for 700 acres; open freshwater accounts for 200 acres; and dune, beach, and brackish marsh accounts for 2200 acres. Industrial, infrastructure, and administrative areas make up 10,000 acres and artillery impact areas and buffer zones account for 11,000 acres (LeBlond, 1994). The base contains 80 miles of tidal streams, 21 miles of marine shoreline, and 12 freshwater ponds. The soil types range from sandy loams to fine sand and muck, with the dominant series being sandy loam (USMC, 1987).

The base drains primarily to the New River via its tributaries. These tributaries include Northeast Creek, Southwest Creek, Cogdels Creek, Wallace Creek, Frenchs Creek, Bear Head Creek, Brinson Creek, Edwards Creek, and Duck Creek. Site-specific information regarding surface water and drainage features is presented in Section 2.0.

Forested areas within the military reservation are actively managed for timber. Game species are also managed for hunting and ponds are maintained for fishing. Game species managed include wild turkey, white-tailed deer, black bear, grey and fox squirrels, bobwhite quail, eastern cottontail and marsh rabbits, raccoons, and wood ducks. About 150 acres are maintained for wildlife food plots.

1.2.8.2 Sensitive Environments

Two areas on MCB, Camp Lejeune have been registered as designated Natural Areas within the North Carolina Natural Heritage Program. These two areas, which encompass 141 acres, are the Longleaf Pine Natural Area and the Wallace Creek Swamp Natural Area. In addition, 12 other Natural Areas have been recommended for inclusion in the registry.

These Natural Areas contain some of the finest examples of natural communities in North Carolina and support many rare species. A few of these community types are globally rare. The Calcareous Coastal Fringe Forest on the 100-acre midden at Corn Landing is the only known extant example of this community type. Camp Lejeune contains some of the best examples of the following globally-rare, natural community types: Cypress Savanna, Depression Meadow, and Small Depression Pond. The Maritime Evergreen Forest hammocks between Cedar Point and Shell Point are connected by shell tombolos and appear to be a very rare geological formation.

The NC DEHNR's Division of Environmental Management (DEM) has developed guidance pertaining to activities that may impact wetlands (NC DEHNR, 1992). In addition, certain activities affecting wetlands are also regulated by the U.S. Army Corps of Engineers.

The U.S. Fish and Wildlife Service (FWS) has prepared National Wetlands Inventory (NWI) maps for the MCB, Camp Lejeune area. Through stereoscopic analysis of high altitude aerial photographs, wetlands were identified based upon vegetation, visible hydrology, and geography in accordance with Classification of Wetland and Deep-Water Habitats of the United States (Cowardin, et al., 1979). The NWI maps are intended for an initial identification of wetland areas and are not meant to replace an actual wetland delineation survey that may be required by Federal, state and local regulatory agencies.

Site-specific wetland delineations were not conducted at Sites 36, 43, 44, 54, and 86; however, potential wetland areas were noted during the field habitat evaluation. Information regarding potential wetland areas was transferred to the site-specific biohabitat maps provided in Section 2.0. Information regarding sensitive natural areas was reviewed during map preparation and has been transferred to the maps, if applicable.

1.2.8.3 Threatened and Endangered Species

Certain species have been granted protection by the FWS under the Federal Endangered Species Act (16 U.S.C. 1531-1543), and by the North Carolina Wildlife Resources Commission, under the North Carolina Endangered Species Act (G.S. 113-331 to 113-337). The protected species fall into one of the following status classifications: federal or state endangered, threatened or candidate species; state special concern; state significantly rare; or state watch list. While only the federal or state threatened or endangered and state special concern species are protected from certain actions, the other classified species may have protection in the future.

Surveys have been conducted to identify threatened and endangered species at MCB, Camp Lejeune and several programs are underway to manage and protect them. Table 1-4 lists federally protected species present at the base and their protected classification. Of these species, the red-cockaded woodpecker, American alligator, and sea turtles are protected by specific regulatory programs.

The red-cockaded woodpecker requires a mature, living longleaf or loblolly pine environment. The birds live in family groups and young are raised cooperatively. At MCB, Camp Lejeune, 2,512 acres of habitat have been identified and marked for protection. Approximately 3,300 acres are in actively managed red-cockaded woodpecker colonies. Research on the bird at MCB, Camp Lejeune began in 1985 and information has been collected to determine home ranges, population size and composition, reproductive success, and habitat use. An annual roost survey is conducted and 36 colonies of birds have been located.

The American alligator is considered a state special concern specie. It is found in freshwater, estuarine, and saltwater wetlands in MCB, Camp Lejeune. Base wetlands are maintained and protected for alligators; signs have been posted where alligators are known to live. Annual surveys of Wallace, Southwest, French, Duck, Mill, and Stone Creeks have been conducted since 1977 to identify alligators and their habitats on base.

Two protected sea turtles, the Atlantic loggerhead and Atlantic green turtle, nest on Onslow Beach at MCB, Camp Lejeune. The green turtle was found nesting in 1980; this sighting was the first time the species had been observed nesting north of Georgia. The turtle returned to nest in 1985. Turtle nests on the beach are surveyed and protected, turtles are tagged, and annual turtle status reports are issued.

Three bird species, piping plover, Bachmans sparrow, and peregrine falcon have also been identified during surveys at MCB, Camp Lejeune. The piping plover is a shore bird. Piping plovers prefer beaches with broad open sandy flats above the high tide line and feed along the edge of incoming waves. Like the piping plover, Bachmans sparrows have very specific habitat requirements. The sparrows live in open stretches of pines with grasses and scattered shrubs for ground cover. Bachmans sparrows were observed at numerous locations throughout southern portion MCB, Camp Lejeune.

In addition to the protected species that breed or forage at MCB, Camp Lejeune, several protected whales migrate through the coastal waters off the base during spring and fall. These include the Atlantic right whale, finback whale, sei whale, and sperm whale. Before artillery or bombing practice is conducted in the area, aerial surveys are made to assure that whales are not present in the impact areas.

A natural heritage resource study was conducted at MCB, Camp Lejeune (LeBlond, 1994) to identify threatened or endangered plants and areas of significant natural interest. During the resource study 55 rare plant species were documented from Camp Lejeune. These include 1 specie that is classified as Federal Endangered, 1 specie that is classified as Federally Threatened, 9 that are candidates for federal listing as Endangered or Threatened, 4 that are listed as Endangered or Threatened in the State of North Carolina, and 27 species that are State Rare or State Special Concern. These species are summarized on Table 1-4. In addition, species that are candidates for state listing or are on the North Carolina state watch list were noted.

1.2.9 Land Use Demographics

MCB, Camp Lejeune encompasses an area of approximately 234 square miles. The Installation border is approximately 70 miles, including 21 miles of ocean front and Intracoastal Waterway. Recently, MCB, Camp Lejeune acquired approximately 41,000 additional acres in the Greater Sandy Run area. Table 1-5 provides a breakdown of land uses within the developed portion of the facility.

Land use within MCB, Camp Lejeune is influenced by topography and ground cover, environmental policy, and base operational requirements. Much of the land within MCB, Camp Lejeune consists of freshwater swamps that are wooded and largely unsuitable for development. In addition, 3,000 acres of sensitive estuary and other areas set aside for the protection of threatened and endangered species are to remain undeveloped. Operational restrictions and regulations, such as explosive quantity safety distances, impact-weighted noise thresholds, and aircraft landing and clearance zones, may also greatly constrain and influence development (Master Plan, 1988).

The combined military and civilian population of the MCB, Camp Lejeune and Jacksonville area is approximately 112,000. Nearly 90 percent of the surrounding population resides within urbanized areas. The presence of MCB, Camp Lejeune has been the single greatest factor contributing to the rapid population growth of Jacksonville and adjacent communities, particularly during the period from 1940 to 1960.

1.2.9.1 MCAS, New River

MCAS, New River encompasses 2,772 acres and is located in the northwestern portion of the MCB, Camp Lejeune complex. MCAS, New River includes air support activities, troop housing, and personnel support facilities that surround the aircraft operations and maintenance areas. The air station primarily functions as a helicopter base, however, an increasing contingent of fixed-wing aircraft are also supported. Its present mission is to maintain and operate facilities that provide services and material to sustain operations of Marine Air Groups (MAG) 26 and 29, the two tenant commands. MCAS, New River also maintains a number of other activities and units as designated by the Commandant of the Marine Corps and the Chief of Naval Operations.

1.2.10 Meteorology

Although coastal North Carolina lacks distinct wet and dry seasons, there is some seasonal variation in average precipitation. July tends to receive the most precipitation, and rainfall amounts during summer are generally the greatest. Daily showers during the summer are not uncommon, nor are periods of one or two weeks without rain. Convective showers and thunderstorms contribute to the variability of precipitation during the summer months. October tends to receive the least amount of precipitation, on average. Throughout the winter and spring precipitation occurs primarily in the form of migratory low pressure storms. MCB, Camp Lejeune's average yearly rainfall is 52.4 inches. Table 1-6 presents a climatic summary of data collected during 35 years (January 1955 to December 1990) of observations at MCAS New River.

Coastal Plain temperatures are moderated by the proximity of the Atlantic Ocean, which effectively reduces the average daily fluctuation of temperature. Lying 50 miles offshore at its nearest point, the Gulf Stream tends to have little direct effect on coastal temperatures. The southern reaches of the cold Labrador Current offset any warming effect the Gulf Stream might otherwise provide.

MCB, Camp Lejeune experiences hot and humid summers; however, ocean breezes frequently produce a cooling effect. The winter months tend to be mild, with occasional brief cold spells. Average daily temperatures range from 34°F to 54°F in January, the coldest month, and 72°F to 89°F in July, the hottest month. The average relative humidity, between 78 and 89 percent, does not vary greatly from season to season.

Observations of sky conditions indicate yearly averages of approximately 112 days clear, 105 partly cloudy, and 148 cloudy. Measurable amounts of rainfall occur 118 days per year, on the average. Prevailing winds are generally from the south-southwest 10 months of the year and from the north-northwest during September and October. The average wind speed at MCAS, New River is seven miles per hour.

1.3 Background and Setting of Site 43

The following section provides both the location and setting of Site 43. A brief summary of past waste disposal activities at Site 43 is also provided within this section.

1.3.1 Site Location and Setting

The Agan Street Dump (Site 43) is comprised of approximately 11 acres and is located within the operations area of MCAS, New River, 2 miles west of the main entrance (see Figure 1-1). Vehicle access to the site is via Agan Street, from Curtis Road.

Figure 1-5 presents a site map of the Agan Street Dump. As shown, the site is located at the northern terminus of Agan Street, adjacent to an abandoned sewage disposal facility. The site is bordered to the north by Edwards Creek, to the east and south by Strawhorn Creek, and to the west by Agan Street and the former sewage disposal facility. Strawhorn Creek discharges into Edwards Creek at Site 43. Edwards Creek then discharges into the New River approximately 2,000 feet north of the study area, near Site 36.

Much of the site is heavily vegetated with dense understory and trees greater than three inches in diameter. Marsh areas that are prone to flooding line both Strawhorn and Edwards Creeks. An

improved gravel loop road provides access to the main portion of the study area; other unimproved paths extend outward from this road. Base housing units and related facilities are situated to west, on the opposite side of Agan Street. A child daycare/minischool is located approximately 250 feet southwest of the study area boundary. The Baseline Human Health Risk Assessment, provided in Section 6.0, presents information concerning the potential site-related exposure scenarios for nearby residents.

1.3.2 Site History

The Agan Street Dump reportedly received mainly inert material such as construction debris (i.e., fiberglass and lumber) and trash. Sludge from a former sewage disposal facility, located adjacent to the study area, was also dumped onto the ground surface of Site 43 (WAR, 1983). The years during which disposal operations took place are not known.

1.4 Previous Investigations

The following subsections describe previous investigation activities at OU No.6, Site 43. These investigations include an Initial Assessment Study (IAS), a Site Inspection (SI), and an additional groundwater investigation.

1.4.1 Initial Assessment Study

In 1983, an IAS was conducted at MCB, Camp Lejeune and MCAS, New River by Water and Air Research, Inc. (WAR). The IAS evaluated the potential hazards at various sites throughout the facility, including Site 43. The IAS was based upon review of historical records, aerial photographs, a site visit, and personnel interviews. The IAS conclusions indicated that waste quantities at Site 43, regardless of its nature, were minor. Therefore, a Confirmation Study was not recommended for the study area.

1.4.2 Site Inspection

In 1991, Baker conducted an SI at Site 43. The SI consisted of the following field activities: the installation and sampling of three monitoring wells (43-GW01, 43-GW02, and 43-GW03); the collection of two soil samples from each monitoring well test boring (one near the surface and one just above the water table); the collection of two soil samples from five additional soil borings; and the collection of five surface water and sediment samples from adjacent creeks and marsh. Table 1-7 provides well construction details of the three shallow monitoring wells installed during the SI at Site 43. Figure 1-6 identifies the specific SI sampling locations.

Upon visual inspection of the site, no conclusive signs of hazardous waste disposal were apparent. It was suspected that frequent flooding of the area may have dispersed any visual signs of possible contamination. In addition, no visual evidence of disposal was encountered in any of the soil borings.

The following paragraphs briefly describe the results and conclusions of the SI at Site 43. Tables 1-8 through 1-12 present laboratory analytical results from the SI.

1.4.2.1 Soil Investigation

Polynuclear aromatic hydrocarbons (PAHs) were detected in the surface soil sample obtained from monitoring well test boring 43-GW01. The total PAH concentration at this location was less than 2,000 µg/kg. Based upon SI results, it was suggested that PAHs were not limited to this area; two downgradient sediment samples also exhibited low levels of PAHs. No other area of the site exhibited similar organic soil contamination. None of the contaminants detected exceeded risk-based concentrations (RBCs), however various inorganic contaminants such as barium, copper, manganese, nickel, and calcium exceeded twice the base-specific background levels in one or more of the ten soil samples. No inorganic concentrations exceeded regional background values, though. Tables 1-8 and 1-9 present positive detections of organic and inorganic soil analytical results from the SI at Site 43, respectively.

1.4.2.2 Groundwater Investigation

Carbon disulfide was the only organic contaminant detected in groundwater. Carbon disulfide was not detected in any other environmental media at Site 43. Beryllium, cadmium, chromium, lead, iron, manganese, and nickel (all total metals) were detected at concentrations which exceeded either federal Maximum Contaminant Levels (MCLs) or North Carolina Water Quality Standards (NCWQS). However, studies conducted at several sites throughout MCB, Camp Lejeune have also exhibited concentrations of total metals in excess of water quality standards. These elevated concentrations of total metals have been correlated with sample turbidity. The results of these analyses tend to reflect the presence of suspended material in groundwater samples rather than depict true groundwater conditions. Table 1-10 presents the groundwater analytical results from the SI at Site 43.

1.4.2.3 Surface Water and Sediment Investigation

Aluminum, copper, iron, lead, manganese, and zinc were detected in surface water samples above state or federal standards. Based on these standards, aquatic life could potentially be adversely impacted. However, contamination was not widespread and the concentrations only slightly exceeded water quality standards. Benzoic acid (a semivolatile organic compound) was the only organic contaminant detected in the surface water samples. There is no state water quality standard, federal Ambient Water Quality Criteria (AWQC), or Freshwater Water Quality Screening Value (FWQSV) for benzoic acid. Table 1-11 presents the surface water analytical results.

It was suggested, as part of the SI findings, that PAHs may have migrated via surface runoff into Edwards Creek and the low-lying marsh areas. PAHs were detected at the confluence of Edwards Creek and Strawhorn Creek, downgradient of the soil sample location where PAHs were detected at the surface. In addition to PAHs at two of the five sediment sampling locations, the pesticides 4,4'-DDE and 4,4'-DDD were detected at three locations with concentrations of less than 580 µg/kg. No pesticides were detected in soil, groundwater, or surface water. The pesticides may be associated with historical mosquito control practices. Low pesticide levels have also been detected in soil and sediment media throughout MCB, Camp Lejeune.

Lead, nickel, and zinc exceeded sediment screening values for the protection of biota. The concentrations of these contaminants were within the "possible" adverse effects to biota range. Table 1-12 presents the sediment analytical results generated during the SI at Site 43.

1.4.2.4 Recommendations of the Site Inspection

Based on the findings of the SI, an RI/FS, including a human health and ecological risk assessment, was recommended to further evaluate the nature and extent of soil, sediment, surface water, and groundwater contamination. Also, further characterization of upgradient groundwater and background soil, surface water, and sediment was recommended.

1.4.3 Additional Investigations

In 1994, Baker performed additional groundwater investigations prior to conducting the RI. The additional investigation at Site 43 included groundwater sampling of the three existing monitoring wells that were installed during the SI (43-GW01, 43-GW02, and 43-GW03). These samples were collected to determine if vandalism of the wells had impacted groundwater or the wells themselves. (This vandalism included the removal of well caps at all three wells and the lodging of a metal can into one well.) Figure 1-6 identifies the specific sampling locations.

The three samples were analyzed for TCL organics and TAL metals (total and dissolved). Table 1-13 presents the analytical results for positively detected contaminants. As shown, methylene chloride was the only volatile organic compound (VOC) detected in the samples, however, its presence was attributed to laboratory contamination rather than site-related contamination. Bis (2-ethylhexyl) phthalate (BEHP) and di-n-butyl phthalate were the only semivolatiles organic compounds, but their presence was also attributed to laboratory contamination. Pesticides and PCBs were not detected in any of the samples. TAL metals, however, were detected in all three samples. Total concentrations of cadmium, beryllium, manganese, iron, lead, and chromium exceeded NCWQS or federal MCLs. (These analytes were also detected at elevated concentrations during the 1991 Site Inspection.) Dissolved concentrations of iron and lead were also detected above standards.

Results from the additional groundwater investigation indicated that vandalism had not impacted the usability of the existing monitoring wells at Site 43. Therefore, the wells would be employed during future groundwater sampling investigations. However, it was recommended that the site be secured to prevent future vandalism.

1.5 Remedial Investigation Objectives

The purpose of this section is to define the RI objectives that were intended to characterize past waste disposal activities at Site 43, assess potential impacts to public health and environment, and provide feasible alternatives for consideration during preparation of the ROD. The remedial objectives presented in this section have been identified through review and evaluation of existing background information, assessment of potential risks to public health and environment, and consideration of feasible remediation technologies and alternatives. As part of the remedial investigation at Site 43, soil, groundwater, surface water, and sediment investigations were conducted. The information gathered during these investigations was intended to fill previously existing data gaps and employed to generate human health and ecological risk values. Table 1-14 presents the RI objectives identified for Site 43. In addition, the table provides a general description of the study or investigation efforts that were conducted to obtain the requisite information.

1.6 References

Atlantic Division, Naval Facilities Engineering Command. January 1988. Camp Lejeune Complex Master Plan and Capital Improvements Plan Update. Prepared for the Commanding General, Marine Corps Base, Camp Lejeune, North Carolina.

Baker Environmental, Inc. January 1994. Site Inspection Report - Site 43, Agan Street Dump. Final. Prepared for the Department of the Navy, Naval Facilities Engineering Command, Atlantic Division, Norfolk, Virginia.

Baker Environmental, Inc. December 1994. Remedial Investigation/Feasibility Study Work Plan for Operable Unit No. 6 (Sites 36, 43, 44, 54, and 86), Marine Corps Base Camp Lejeune, North Carolina. Final. Prepared for the Department of the Navy, Naval Facilities Engineering Command, Atlantic Division, Norfolk, Virginia.

Baker Environmental, Inc. May 1995. Site Management Plan for Marine Corps Base Camp Lejeune, North Carolina. Draft. Prepared for the Department of the Navy, Naval Facilities Engineering Command, Atlantic Division, Norfolk, Virginia.

Cardinell, A.P., Berg, S.A., and Lloyd, O.B. 1993. Hydrogeologic Framework of U.S. Marine Corps Base at Camp Lejeune, North Carolina: U.S. Geological Survey Water Resources Investigation Report. Report No. 93-4049.

Cowardin, Lewis M., Virginia Carter, Francis C. Golet, and Edward T. LaRoe. December 1979. Classification of Wetlands and Deepwater Habitats of the United States. Performed for U.S. Department of the Interior, Fish and Wildlife Service, Office of Biological Services - FWS/OBS-79/31.

Environmental Science and Engineering, Inc. (ESE) 1990. Site Summary Report. Final. Marine Corps Base, Camp Lejeune, North Carolina. Prepared for the Department of the Navy, Naval Facilities Engineering Command, Atlantic Division, Norfolk, Virginia. ESE Project No. 49-02036.

Environmental Science and Engineering, Inc. (ESE) 1988. Characterization Step Report for Hadnot Point Industrial Area. Marine Corps Base, Camp Lejeune, North Carolina. Prepared for the Department of the Navy, Naval Facilities Engineering Command, Atlantic Division, Norfolk, Virginia. ESE Project No. 49-02036-0150.

Federal Facilities Agreement (FFA) Between United States Environmental Protection Agency, Region IV; the North Carolina Department of Environment, Health, and Natural Resources; and United States Department of the Navy for Marine Corps Base, Camp Lejeune and Marine Corps Air Station, New River, North Carolina. December 6, 1989.

Harned, D.A., Lloyd, O.B., Jr., and Treece, M.W., 1989. Assessment of Hydrologic and Hydrogeologic Data at Camp Lejeune Marine Corps Base, North Carolina: U.S. Geological Survey Water Resources Investigation. Report 89-4096, p. 64.

LeBlond, Richard J., John O. Fussell, and Alvin L. Broswell. February 1994. Inventory of Rare Species, Natural Communities, and Critical Areas of the Camp Lejeune Marine Corps Base, North Carolina. North Carolina Natural Heritage Program, Division of Parks and Recreation, Department of Environment, Health, and Natural Resources, Raleigh, North Carolina.

North Carolina Department of Environment, Health, and Natural Resources NC DEHNR May 1992. Interim Guidance for Wetlands Protection. Division of Environment, Water Quality Section.

U.S. Department of the Interior (USDI). March 1982. National Wetland Inventory Map, Camp Lejeune, N.C. Fish and Wildlife Service.

U.S. Marine Corps, MCB, Camp Lejeune (USMC). 1987. Multiple-Use Natural Resources Management Plan. Fish and Wildlife Division, Environmental Management Department, Marine Corps Base, Camp Lejeune, North Carolina.

Water and Air Research, Inc. (WAR) April 1983. Initial Assessment Study of Marine Corps Base Camp Lejeune, North Carolina. Prepared for the Department of the Navy, Naval Energy and Environmental Support Activity, Port Hueneme, California.

SECTION 1.0 TABLES

TABLE 1-1

**GEOLOGIC AND HYDROGEOLOGIC UNITS OF
NORTH CAROLINA'S COASTAL PLAIN
REMEDIAL INVESTIGATION, CTO-0303
MCAS, NEW RIVER, NORTH CAROLINA**

Geologic Units			Hydrogeologic Units
System	Series	Formation	Aquifer and Confining Unit
Quaternary	Holocene/Pleistocene	Undifferentiated	Surficial aquifer
Tertiary	Pliocene	Yorktown Formation ⁽¹⁾	Yorktown confining unit
		Eastover Formation ⁽¹⁾	Yorktown Aquifer
	Miocene	Pungo River Formation ⁽¹⁾	Pungo River confining unit
			Pungo River Aquifer
		Belgrade Formation ⁽²⁾	Castle Hayne confining unit
	Oligocene	River Bend Formation	Castle Hayne Aquifer
	Eocene	Castle Hayne Formation	Beaufort confining unit ⁽³⁾
Paleocene	Beaufort Formation	Beaufort Aquifer	
Cretaceous	Upper Cretaceous	Peedee Formation	Peedee confining unit
			Peedee Aquifer
		Black Creek and Middendorf Formations	Black Creek confining unit
			Black Creek Aquifer
		Cape Fear Formation	Upper Cape Fear confining unit
			Upper Cape Fear Aquifer
	Lower Cape Fear confining unit		
	Lower Cretaceous ⁽¹⁾	Unnamed deposits ⁽¹⁾	Lower Cape Fear Aquifer
			Lower Cretaceous confining unit
		Lower Cretaceous Aquifer ⁽¹⁾	
Pre-Cretaceous basement rocks		--	--

Note:

- ⁽¹⁾ Geologic and hydrologic units probably not present beneath MCB, Camp Lejeune.
- ⁽²⁾ Constitutes part of the surficial aquifer and Castle Hayne confining unit in the study area.
- ⁽³⁾ Estimated to be confined to deposits of Paleocene age in the study area.

Source: Harned et al., 1989.

TABLE 1-2

SUMMARY OF HYDRAULIC PROPERTIES
 UNRELATED SITE INVESTIGATIONS
 REMEDIAL INVESTIGATION, CTO-0303
 MCAS, NEW RIVER, NORTH CAROLINA

Well No.	Hydraulic Conductivity Falling Head Test		Hydraulic Conductivity Rising Head Test		Transmissivity	Storativity
	ft/day	cm/sec	ft/day	cm/sec	gal/day/ft	
MW-30A	1.18	4.16E-04	1.5	5.31E-04	--	--
MW-31A	0.346	1.22E-04	0.269	9.51E-05	--	--
MW-35A	0.119	4.20E-05	0.116	4.06E-05	--	--
MW-32B	6.22	2.20E-03	5.15	1.82E-03	--	--
MW-36B	2.91	1.03E-03	3.2	1.13E-03	--	--
MW-37B	7.06	2.49E-03	6.44	2.27E-03	--	--
GWD-1	6.8	2.40E-03	6.03	2.13E-03	--	--
122MW-3	0.25	8.80E-05	0.015	5.30E-06	--	--
122MW-5	0.47	1.70E-04	0.034	1.20E-05	--	--
122MW-12	0.068	2.40E-05	0.0085	3.00E-06	--	--
MW-13 ⁽¹⁾	0.0554	1.96E-05	0.0032	1.13E-06	--	--
MW-14 ⁽¹⁾	0.188	6.62E-05	7.26E-04	2.56E-07	--	--
MW-3 ⁽²⁾	--	--	0.75	2.60E-04	--	--
MW-4 ⁽²⁾	--	--	0.27	9.50E-05	--	--
MW-11 ⁽²⁾	--	--	0.37	1.30E-04	--	--
MW-21 ⁽²⁾	--	--	0.46	1.60E-04	5.5	0.028
RW-1 ⁽²⁾	--	--	--	--	54	--
MW-18 ⁽²⁾	--	--	--	--	790	0.014

Note: All data compiled from unrelated Baker Investigations with the MCAS, New River operations area.

⁽¹⁾ AS 527

⁽²⁾ Campbell Street Fuel Farm
 A = Upper Surficial Aquifer
 B = Lower Surficial Aquifer

TABLE 1-3

HYDRAULIC PROPERTY ESTIMATES OF THE CASTLE HAYNE AQUIFER
 REMEDIAL INVESTIGATION, CTO-0303
 MCAS, NEW RIVER, NORTH CAROLINA

Hydraulic Properties	USGS Phase I Study ⁽¹⁾	USGS Aquifer Test ⁽²⁾	ESE, Inc. ⁽³⁾	DEHNR Aquifer Test ⁽⁴⁾	RASA Estimate ⁽⁵⁾
Aquifer transmissivity (cubic foot per day per square foot times foot of aquifer thickness)	4,300 to 24,500 average 9,500	1,140 to 1,325	820 to 1,740 average 1,280	900	10,140 to 26,000
Aquifer hydraulic conductivity (foot per day)	14 to 82 average 35	20 to 60	--	18 to 91 average 54	45 to 80 average 65
Aquifer storage coefficient (dimensionless)	--	0.0002 to 0.00022	0.0005 to 0.001 average 0.0008	0.0019	--
Confining-unit vertical hydraulic conductivity (foot per day)	--	0.03 to 0.41	0.0014 to 0.051 average 0.0035	--	--

Note:

- (1) Analysis of specific capacity data from Harned and others (1989).
- (2) Aquifer test at well HP-708.
- (3) Aquifer test at Hadnot Point well HP-462 from Environmental Sciences and Engineering, Inc. (1988).
- (4) Unpublished aquifer test data at well X24s2x, from DEHNR well records (1985).
- (5) Transmissivities based on range of aquifer thickness and average hydraulic conductivity from Winner and Coble (1989).

Source: Cardinell, et al., 1993.

TABLE 1-4

**PROTECTED SPECIES WITHIN MCB, CAMP LEJEUNE
REMEDIAL INVESTIGATION, CTO-0303
MCAS, NEW RIVER, NORTH CAROLINA**

Species	Protected Classification
Animals:	
American alligator (<i>Alligator mississippiensis</i>)	SC
Bachmans sparrow (<i>Aimophila aestivalis</i>)	FCan, SC
Green (Atlantic) turtle (<i>Chelonia m. mydas</i>)	T(f), T(s)
Loggerhead turtle (<i>Caretta caretta</i>)	T(f), T(s)
Peregrine falcon (<i>Falco peregrinus</i>)	E(f), E(s)
Piping plover (<i>Charadrius melodus</i>)	T(f), T(s)
Red-cockaded woodpecker (<i>Picoides borealis</i>)	E(f), E(s)
Southern Hognose Snake (<i>Heterodon simus</i>)	FCan, SR
Diamondback Terrapin (<i>Malaclemys terrapin</i>)	FCan, SC
Carolina Gopher Frog (<i>Rana capito capito</i>)	FCan, SC
Cooper's Hawk (<i>Accipiter cooperii</i>)	SC
Eastern Diamondback Rattlesnake (<i>Crotalus adamanteus</i>)	SR
Eastern Coral Snake (<i>Micrurus fulvius</i>)	SR
Pigmy Rattlesnake (<i>Sistrurus miliarius</i>)	SR
Black Bear (<i>Ursus americanus</i>)	SR
Plants:	
Rough-leaf loosestrife (<i>Lysimachia asperulifolia</i>)	E(f), E(s)
Seabeach Amaranth (<i>Amaranthus pumilus</i>)	T(f), T(s)
Chapman's Sedge (<i>Carex chapmanii</i>)	FCan
Hirst's Witchgrass (<i>Dichanthelium</i> sp.)	FCan
Pondspice (<i>Litsea aestivalis</i>)	FCan
Boykin's Lobelia (<i>Lobelia boykinii</i>)	FCan
Loose Watermilfoil (<i>Myriophyllum laxum</i>)	FCan, T(s)
Awed Meadowbeauty (<i>Rhexia aristosa</i>)	FCan, T(s)
Carolina Goldenrod (<i>Solidago pulchra</i>)	FCan, E(s)
Carolina Asphodel (<i>Tofieldia glabra</i>)	FCan
Venus Flytrap (<i>Dionaea muscipula</i>)	FCan
Flaxleaf Gerardia (<i>Agalinis linifolia</i>)	SR
Pinebarrens Goobar Grass (<i>Amphicarpum purshii</i>)	SR
Longleaf Three-awn (<i>Aristida palustris</i>)	SR
Pinebarrens Sandreed (<i>Calamovilfa brevipilis</i>)	E(s)
Warty Sedge (<i>Carex verrucosa</i>)	SR
Smooth Sawgrass (<i>Cladium mariscoides</i>)	SR
Leconte's Flatsedge (<i>Cyperus lecontei</i>)	SR
Erectleaf Witchgrass (<i>Dichanthelium erectifolium</i>)	SR
Horsetail Spikerush (<i>Eleocharis equisetoides</i>)	SR
Sand Spikerush (<i>Eleocharis montevidensis</i>)	SR

TABLE 1-4 (Continued)

PROTECTED SPECIES WITHIN MCB, CAMP LEJEUNE
 REMEDIAL INVESTIGATION, CTO-0303
 MCB, CAMP LEJEUNE, NORTH CAROLINA

Species	Protected Classification
Flaxleaf Seedbox (<i>Ludwigia linifolia</i>)	SR
Torrey's Muhley (<i>Muhlenbergia torreyana</i>)	E(s)
Southeastern Panic Grass (<i>Panicum tenerum</i>)	SR
Spoonflower (<i>Peltandra sagittifolia</i>)	SR
Shadow-witch (<i>Ponthieva racemosa</i>)	SR
West Indies Meadowbeauty (<i>Rhexia cubensis</i>)	SR
Pale Beakrush (<i>Rhynchospora pallida</i>)	SR
Longbeak Bardsedge (<i>Rhynchospora scirpoides</i>)	SR
Tracy's Beakrush (<i>Rhynchospora tracyi</i>)	SR
Canby's Bulrush (<i>Scirpus etuberculatus</i>)	SR
Slender Nutrush (<i>Scleria minor</i>)	SR
Lejeune Goldenrod (<i>Solidago</i> sp.)	SR
Dwarf Bladderwort (<i>Utricularia olivacea</i>)	T(s)
Elliott's Yellow-eyed Grass (<i>Xyris elliotii</i>)	SR
Carolina Dropseed (<i>Sporobolus</i> sp.)	T(s)

Legend:

- E(f) = Federal Endangered
- T(f) = Federal Threatened
- Fcan = Candidate for Federal Listing
- E(s) = State Endangered
- T(s) = State Threatened
- SC = State Special Concern
- SR = State Rare

Source: LeBlond, 1994

TABLE 1-5

**LAND UTILIZATION WITHIN DEVELOPED AREAS OF MCB, CAMP LEJEUNE
REMEDIAL INVESTIGATION, CTO-0303
MCAS, NEW RIVER, NORTH CAROLINA**

Geographic Area	Operation	Training (Instruc.)	Maintenance	Supply/ Storage	Medical	Admin- istration	Family Housing	Troop Housing	CM	CO	Recreation	Utility	Total
Hadnot Point	31 (2.9)	15 (1.4)	154 (14.3)	157 (14.4)	10 (0.9)	122 (11.3)	22 (2.0)	196 (18.1)	115 (10.7)	36 (3.3)	182 (16.9)	40 (3.7)	1,080 (100)
Paradise Point	1 (0)		3 (0.4)	1 (0)			343 (34)	19 (1.9)	31 (3.1)		610 (60.4)	2 (0.2)	1,010 (100)
Berkeley Manor/ Watkins							406 (80)		41 (8.1)	1 (0.2)	57 (11.2)	2 (0.5)	507 (100)
Midway Park		1 (0.4)		2 (0.7)		2 (0.7)	248 (92.2)		8 (3.0)	3 (1.1)	4 (1.5)	1 (0.4)	269 (100)
Tarawa Terrace I and II			3 (0.5)			1 (0.3)	428 (77.4)		55 (9.9)	11 (2.0)	47 (8.5)	8 (1.4)	553 (100)
Knox Trailer							57 (100)						
French Creek	8 (1.4)	1 (0.2)	74 (12.7)	266 (45.6)	3 (0.5)	7 (1.2)		122 (20.9)	22 (3.8)	6 (1.0)	74 (12.7)		583 (100)
Courthouse Bay		73 (28.6)	28 (10.9)	14 (5.5)		12 (4.7)	12 (4.7)	43 (16.9)	15 (5.9)	4 (1.6)	43 (16.9)	11 (4.3)	255 (100)
Onslow Beach	6 (9.8)	1 (1.6)	3 (4.8)	2 (3.2)	1 (1.6)	2 (3.2)		2 (3.2)	12 (19.3)		25 (40.3)	8 (13.0)	62 (100)
Rifle Range		1 (1.3)	1 (1.3)	7 (8.8)	1 (1.3)	5 (6.3)	7 (8.8)	30 (37.5)	5 (6.3)	1 (1.3)	9 (11.3)	13 (16.3)	80 (100)
Camp Geiger	4 (1.9)	15 (6.9)	19 (8.8)	50 (23.1)		23 (10.6)		54 (25.0)	27 (12.5)	2 (1.0)	16 (7.4)	6 (2.8)	216 (100)
Montford Point	6 (2.6)	48 (20.5)	2 (0.9)	4 (1.7)	2 (0.9)	9 (3.9)		82 (35.2)	20 (8.6)	1 (0.4)	49 (21.0)	10 (4.3)	233 (100)
Base-Wide Misc.	1 (0.8)			87 (68.0)		3 (2.3)			19 (14.8)			18 (14.1)	128 (100)
TOTAL	57 (1.)	155 (3.1)	287 (5.7)	590 (11.7)	17 (0.38)	186 (3.7)	1,523 (30.2)	548 (10.8)	370 (7.4)	65 (1.3)	1,116 (22.2)	119 (2.4)	5,033 (100)

Notes:

Numbers without parentheses represent total acres.
Numbers within parentheses represent percentage of total acres.
Source: Master Plan, 1988

TABLE 1-6

CLIMATIC DATA SUMMARY
 MARINE CORPS AIR STATION, NEW RIVER
 REMEDIAL INVESTIGATION, CTO-0303
 MCAS, NEW RIVER, NORTH CAROLINA

	Precipitation (Inches)			Relative Humidity (Percent)	Temperature (Fahrenheit)			Mean Number of Days With				
	Maximum	Minimum	Average		Maximum	Minimum	Average	Precipitation		Temperature		
								>=0.01"	>=0.5"	>=90F	>=75F	<=32F
January	7.5	1.4	4.0	79	54	34	44	11	2	0	1	16
February	9.1	.9	3.9	78	57	36	47	10	3	0	2	11
March	8	.8	3.9	80	64	43	54	10	3	*	5	5
April	8.8	.5	3.1	79	73	51	62	8	2	1	13	*
May	8.4	.6	4.0	83	80	60	70	10	3	2	25	0
June	11.8	2.2	5.2	84	86	67	77	10	4	7	29	0
July	14.3	4.0	7.7	86	89	72	80	14	5	13	31	0
August	12.6	1.7	6.2	89	88	71	80	12	4	11	31	0
September	12.8	.8	4.6	89	83	66	75	9	3	4	27	0
October	8.9	.6	2.9	86	75	54	65	7	2	*	17	*
November	6.7	.6	3.2	83	67	45	56	8	2	0	7	3
December	6.6	.4	3.7	81	58	37	48	9	2	0	2	12
Annual	65.9	38.2	52.4	83	73	53	63	118	35	39	189	48

Note:

* = Mean no. of days less than 0.5 days

Source: Naval Oceanography Command Detachment, Asheville, North Carolina. Measurements obtained from January 1955 to December 1990.

TABLE 1-7

SUMMARY OF WELL CONSTRUCTION DETAILS
SITE INSPECTION
SITE 43, AGAN STREET DUMP
REMEDIAL INVESTIGATION, CTO-0303
MCAS, NEW RIVER, NORTH CAROLINA

Well No.	Date Installed	Top of PVC Casing Elevation (feet, above msl) ⁽¹⁾	Ground Surface Elevation (feet, above msl)	Boring Depth (feet, below ground surface)	Well Depth (feet, below ground surface)	Screen Interval Depth (feet, below ground surface)	Sand Pack Interval Depth (feet, below ground surface)	Bentonite Interval Depth (feet, below ground surface)
43-GW01	8/7/91	8.26	5.42	12	11.5	2-11.5	1.4-11.5	.8-1.4
43-GW02	8/7/91	8.03	4.93	12	12	2-12	1.5-12	1-1.5
43-GW03	8/8/91	6.58	3.52	12	12	2-12	1.5-12	.7-1.5

Notes:

Horizontal positions are referenced to N.C. State Plane Coordinate System (NAD 27) CF = 0.9999216 from USMC Monument Toney.
Vertical datum NGVD 29.

⁽¹⁾ msl = mean sea level

TABLE 1-8

**DETECTED ORGANIC CONTAMINANTS IN SOIL
SITE INSPECTION
SITE 43, AGAN STREET DUMP
REMEDIAL INVESTIGATION, CTO-0303
MCAS, NEW RIVER, NORTH CAROLINA**

Sample Number Sample Depth (feet)	43-GW01-00 0-2'	43-GW01-00DUP 0-2'	43-GW02-00 0-2'	43-GW02-02 2-4'	43-GW03-00 0-2'
Parameter: Units ($\mu\text{g}/\text{kg}$)					
Semivolatiles:					
Phenanthrene	57	ND	ND	ND	ND
Di-n-butylphthalate	89	40	ND	ND	ND
Fluoranthene	230	110	ND	ND	ND
Pyrene	210	94	ND	ND	ND
Benzo(a)anthracene	110	55	ND	ND	ND
Chrysene	160	73	ND	ND	ND
bis(2-Ethylhexyl)phthalate	200	100	49	54	72
Benzo(b)fluoranthene	300	160	ND	ND	ND
Benzo(k)fluoranthene	300	160	ND	ND	ND
Benzo(a)pyrene	110	56	ND	ND	ND
Indeno(1,2,3-cd)pyrene	64	ND	ND	ND	ND
Benzo(g,h,i)perylene	80	42	ND	ND	ND

Notes:

Concentrations reported in micrograms per kilogram ($\mu\text{g}/\text{kg}$); or parts per billion (ppb).

DUP - Duplicate

ND - Not Detected

Source: Baker Environmental, Inc. Site Inspection Report, 1991.

TABLE 1-9

DETECTED INORGANIC CONTAMINANTS IN SOIL
 SITE INSPECTION
 SITE 43, AGAN STREET DUMP
 REMEDIAL INVESTIGATION, CTO-0303
 MCAS, NEW RIVER, NORTH CAROLINA

Sample Number Sample Depth (feet)	43-SB01-00 0-2'	43-SB01-03 3-5'	43-SB02-00 0-2'	43-SB02-00DUP 0-2'	43-SB02-04 4-6'
Parameter: Units (mg/kg)					
Inorganics:					
Aluminum	1,630	4,710	4,020	5,640	2,590
Barium	ND	77.6	ND	ND	ND
Calcium	ND	510	ND	ND	ND
Chromium	2.5	9.7	4.3 J	5.9 J	3.6 J
Copper	2.9	2.0	0.98	1.1	1.1
Iron	763	1,600	3,050	4,790	738
Lead	4.6	2.1	3.6	5.3	4.0
Magnesium	70.6	250	ND	ND	ND
Manganese	ND	23.5	ND	ND	ND
Nickel	ND	ND	ND	ND	ND
Potassium	126	350	ND	ND	ND
Thallium	ND	ND	ND	ND	ND
Vanadium	2.3	7.3	6.9	9.6	2.9
Zinc	4.8	8.4	4.0	ND	ND

Notes:

Concentrations reported in milligrams per kilogram (mg/kg); or per parts per million (ppm).

J - Estimated value, reported value may not be accurate or precise.

ND - Not Detected

DUP - Duplicate

Source: Baker Environmental, Inc. Site Inspection Report, 1991.

TABLE 1-9 (Continued)

DETECTED INORGANIC CONTAMINANTS IN SOIL
 SITE INSPECTION
 SITE 43, AGAN STREET DUMP
 REMEDIAL INVESTIGATION, CTO-0303
 MCAS, NEW RIVER, NORTH CAROLINA

Sample Number Sample Depth (feet)	43-SB03-00 0-2'	43-SB04-03 0-2'	43-SB04-03 3-5'	43-SB05-00 0-2'	43-SB05-06 6-8'
Parameter: Units (mg/kg)					
Inorganics:					
Aluminum	658 J	2,310 J	621 J	5280	489
Barium	2.2	4.9	2.3	ND	ND
Calcium	ND	ND	ND	ND	ND
Chromium	2.2	4.0	1.2	5.7	1.9
Copper	1.2	ND	2.3	5.4	2.2
Iron	419	894	263	2,400	272
Lead	1.6	4.5	1.8	2.7	1.3
Magnesium	29.5	90.6	34.5	142	23.4
Manganese	2.0	5.4	2.2	17.4	ND
Nickel	ND	ND	ND	ND	ND
Potassium	ND	ND	ND	ND	ND
Thallium	ND	ND	ND	ND	ND
Vanadium	1.4	3.7	1.2	6.6	0.95
Zinc	3.1	3.0	3.1	8.0	6.5

Notes:

Concentrations reported in milligrams per kilogram (mg/kg); or per parts per million (ppm).

J - Estimated value, reported value may not be accurate or precise.

ND - Not Detected

DUP - Duplicate

Source: Baker Environmental, Inc. Site Inspection Report, 1991.

TABLE 1-9 (Continued)

DETECTED INORGANIC CONTAMINANTS IN SOIL
 SITE INSPECTION
 SITE 43, AGAN STREET DUMP
 REMEDIAL INVESTIGATION, CTO-0303
 MCAS, NEW RIVER, NORTH CAROLINA

Sample Number Sample Depth (feet)	43-MW01-00 0-2'	43-MW01-00DUP 0-2'	43-MW02-00 0-2'	43-MW02-02 2-4'	43-MW03-00 0-2'
Inorganics:					
Aluminum	3,810	3,720	2,880	4,550	4,460
Barium	ND	ND	ND	ND	ND
Calcium	6720	5,460	93.3	ND	618
Chromium	8.3	6.6	3.6	6.7	6.8
Copper	3.4	1.6	2.5	ND	1.1
Iron	2,190	1,800	1,530	1,340	2,140
Lead	9.8	12.0	3.7	6.1	7.8 J
Magnesium	270	224	95.0	176	177
Manganese	31.2	17.7	7.9	8.2	7.4
Nickel	7.6	ND	2.2	7.3	3.0
Potassium	ND	ND	ND	ND	ND
Thallium	ND	ND	ND	ND	ND
Vanadium	7.2	7.1	4.4	5.8	6.7
Zinc	20.1	8.3	3.6	3.0	3.5

Notes:

Concentrations reported in milligrams per kilogram (mg/kg); or per parts per million (ppm).

J - Estimated value, reported value may not be accurate or precise.

ND - Not Detected

DUP - Duplicate

Source: Baker Environmental, Inc. Site Inspection Report, 1991.

TABLE 1-10
DETECTED TARGET CONTAMINANTS IN GROUNDWATER
SITE INSPECTION
SITE 43, AGAN STREET DUMP
REMEDIAL INVESTIGATION, CTO-0303
MCAS, NEW RIVER, NORTH CAROLINA

Sample Number Sample Depth (feet)	Standards		43-GW01	43-GW02	43-GW03	43-GW03 DUP
	MCLs ⁽¹⁾	NCWQS ⁽²⁾				
Volatiles: Carbon Disulfide			7	ND	ND	ND
Inorganics: Arsenic	50	50	ND	23.4	ND	ND
Barium	2,000	--	689	745	220	233
Beryllium	4	--	3.1	4.2	1.5	1.7
Cadmium	5	5	ND	6.9	ND	ND
Calcium	--	--	91,900	10,300	22,300	20,800
Chromium	100	50	177	249	161	181
Cobalt	--	--	6.7	27.7	ND	ND
Copper	1,300	1,000	64.2	67.8	104	94.8
Iron	--	300	70,700	105,000	12,6000	13,4000
Lead	15 ⁽³⁾	15	16.5	28.8	27.7	42.3
Magnesium	--	--	9,720	11,800	6,800	7,400
Manganese	--	50	220	297	72.6	74.1
Mercury	2	1.1	ND	ND	0.24	ND
Nickel	100	100	33.8	143	20.5	29.4
Potassium	--	--	8,210	10,900	5,190	6,010
Sodium	--	--	9,160	14,600	22,100	17,900
Vanadium	--	--	165	233	122	140
Zinc	--	2,100	192 J	661 J	214 J	300 J

Notes:

Concentrations reported in micrograms per liter (µg/L); or parts per billion (ppb).

J - Estimated value, reported value may not be accurate or precise.

ND - Not Detected

DUP - Duplicate

(--)- Standard or criteria not available.

⁽¹⁾ National Primary Drinking Water Regulations, Primary Maximum Contaminant Levels (MCLs)

⁽²⁾ North Carolina Water Quality Standards for Groundwater (NCAC, 1993)

⁽³⁾ Health Advisories (USEPA, 1993), values represent lifetime exposures, except for arsenic and beryllium which represents 10-04 lifetime risk.

Source: Baker Environmental, Inc. Site Inspection Report, 1991.

TABLE 1-11

**DETECTED TARGET CONTAMINANTS IN SURFACE WATER
SITE INSPECTION
SITE 43, AGAN STREET DUMP
REMEDIAL INVESTIGATION, CTO-0303
MCAS, NEW RIVER, NORTH CAROLINA**

Sample Number Sample Depth (feet)	Standards and Criteria						
Parameter: Units (µg/L)	NCWQS ⁽¹⁾	Freshwater Water Screening Value ⁽²⁾	43-SW01	43-SW02	43-SW03	43-SW04	43-SW05
Semivolatiles:							
Benzoic Acid	--	--	ND	2 J	ND	ND	ND
Inorganics:							
Aluminum	--	87	769	803	948	435	529
Barium	1,000	--	14.4	87.6	11.0	24.6	19.5
Calcium	--	--	24,700	48,000	23,100	29,900	4,410
Copper	7	6.54	9.8	7.9	11.3	7.0	ND
Iron	1,000	1,000	3,800	15,700	1,120	3,080	603
Lead	25	1.32	2.9J	7.0J	21.1	2.8J	ND
Magnesium	--	--	1,630	42,300	1,190	2,270	865
Manganese	200	--	153	42.6	45.8	23.8	33.1
Nickel	88	87.71	ND	ND	ND	9.2	ND
Potassium	--	--	1,250	13,000J	ND	1,650	ND
Sodium	--	--	7,290	401,000	2,930	14,100	2,910
Vanadium	--	--	4.7	3.8	4.4	ND	ND
Zinc	50	58.91	ND	ND	54.3	53.0	ND

Notes:

Concentrations reported in micrograms per liter (µg/L); or parts per billion (ppb).

J - Estimated value, reported value may not be accurate or precise.

ND - Not Detected

DUP - Duplicate

(--)- Standard or criteria not available.

⁽¹⁾North Carolina Water Quality Standards for Groundwater (NCAC, 1993)

⁽²⁾Health Advisories (USEPA, 1993), values represent lifetime exposures, except for arsenic and beryllium which represents 10-04 lifetime risk.

Source: Baker Environmental, Inc. Site Inspection Report, 1991.

TABLE 1-12

**DETECTED TARGET CONTAMINANTS IN SEDIMENT
SITE INSPECTION
SITE 43, AGAN STREET DUMP
REMEDIAL INVESTIGATION, CTO-0303
MCAS, NEW RIVER, NORTH CAROLINA**

Sample Number	NOAA SSV ⁽¹⁾		43-SD01	43-SD02	43-SD03	43-SD04	43-SD05
	Parameter: Units	ER-L ⁽²⁾					
Semivolatiles (µg/kg):							
2-Methylphenol	--	--	810 J	ND	ND	ND	ND
4-Methylphenol	--	--	810 J	ND	ND	ND	64 J
Benzoic Acid	--	--	7600 J	3000 J	ND	ND	ND
Di-n-butylphthalate	--	--	210 J	170 J	59 J	ND	61 J
Pyrene	350	2,200	150 J	ND	ND	ND	ND
Butylbenzophthalate	--	--	ND	ND	55 J	ND	ND
bis(2-Ethylhexyl)phthalate	--	--	ND	ND	ND	1600 J	150 J
Benzo(b)fluoranthene	4,000 ⁽⁴⁾	35,000 ⁽⁴⁾	290 J	ND	66 J	ND	ND
Benzo(k)fluoranthene	4,000 ⁽⁴⁾	35,000 ⁽⁴⁾	290 J	ND	66 J	ND	ND
Pesticides/PCBs (µg/kg):							
4,4'-DDE	2	15	270	580	ND	ND	ND
4,4'-DDD	2	20	500	310	ND	ND	180
4,4'-DDT	1	7	200	ND	ND	ND	ND
Inorganics (mg/kg):							
Aluminum	--	--	6720 J	4,510 J	1,850	1,520	1,970
Barium	--	--	25.5 J	32.6 J	ND	ND	ND
Calcium	--	--	9,170 J	3,330 J	7,500	6,880	4,400
Chromium	80	145	6.9 J	5.0 J	3.6	4.2	2.9
Copper	70	390	13.2 J	9.2 J	1.9	3.6	2.6
Iron	--	--	6,930 J	2,850 J	787	1,720	1,290
Lead	35	110	28.3 J	56.0 J	7.4	28.2	8.5
Magnesium	--	--	831 J	1,300 J	185	170	259
Manganese	--	--	92.1 J	8.9 J	6.7	6.5	6.8
Nickel	30	50	33.4 J	ND	3.7	3.5	ND
Sodium	ND	ND	ND	2,930 J	ND	ND	ND
Vanadium	--	--	18.6 J	12.9 J	3.6	5.0	4.0
Zinc	120	270	77.0 J	26.9 J	11.6	96.2	10.5

TABLE 1-12 (Continued)

**DETECTED INORGANIC CONTAMINANTS IN SEDIMENT
SITE INSPECTION
SITE 43, AGAN STREET DUMP
REMEDIAL INVESTIGATION, CTO-0303
MCAS, NEW RIVER, NORTH CAROLINA**

Notes:

Organic concentrations reported in micrograms per kilogram ($\mu\text{g}/\text{kg}$); or parts per billion (ppb).

Inorganic concentrations reported in milligrams per kilogram (mg/kg); or parts per million (ppm).

J - Estimated value, reported value may not be accurate or precise.

ND - Not Detected

(--)- Standard or criteria not available.

⁽¹⁾ NOAA SSV - National Oceanic and Atmospheric Administration Sediment Screening Values (USEPA Region IV, 1992)

⁽²⁾ ER-L - Effects range - low, if contaminant concentrations fall below the ER-L adverse aquatic effects are considered unlikely.

⁽³⁾ ER-M - Effects range - median, if contaminant concentrations fall above the ER-M adverse aquatic effects are considered probable.

If the value falls between ER-L and ER-M adverse aquatic effects are considered possible.

Source: Baker Environmental, Inc. Site Inspection Report, 1991.

TABLE 1-13

**DETECTED TARGET CONTAMINANTS IN GROUNDWATER
RI SCOPING INVESTIGATION
SITE 43, AGAN STREET DUMP
REMEDIAL INVESTIGATION, CTO-0303
MCAS, NEW RIVER, NORTH CAROLINA**

Contaminant	Federal ⁽¹⁾ MCL (µg/L)	NCWQS ⁽²⁾ (µg/L)	Well Number		
			43-GW01	43-GW02	43-GW03
Volatiles (µg/kg):					
Methylene Chloride	--	5.0	--	1.0 J	--
Semivolatiles (µg/kg):					
Bis(2-ethylhexyl)phthalate	--	--	--	3.0 J	2.0
Di-n-butyl phthalate	--	--	--	--	1.0
Pesticides/PCBs (µg/L):	--	--	None Detected		
Metals (Total) (µg/L):					
Barium	2,000	2,00	1,180	376	705
Cadmium	5.0	5.0	3.0 B	4.8 B	11.2
Copper	1,300	1,000	26.9	39.6	55.2
Aluminum	--	--	10,700	61,500	119,000
Beryllium	4.0	--	4.3 B	1.9 B	4.7 B
Cobalt	--	--	5.0 B	11.5 B	9.9 B
Magnesium	--	--	5,340	4,100 B	6,730
Nickel	100	100	9.8 B	64.5	26 B
Manganese	50	50	165	114	82.8
Zinc	5,000	2,100	155	208	219
Vanadium	--	--	124	73.8	219
Sodium	--	--	8,470	10,300	7,190
Potassium	--	--	7,400	3,650 B	3,940 B
Iron	300	300	75,900	39,700	326,000
Calcium	--	--	75,900	4,930	40,500
Silver	100	18	--	--	2.5 B
Lead	15 ⁽³⁾	15	48.1	68	154
Chromium	100	50	123	72.9	341
Antimony	6.0	--	--	--	--
Metals (Dissolved) (µg/L):					
Barium	1,000	1,000	13.1 B	38.2	45.4
Cadmium	5.0	5.0	3.4 B	--	--
Copper	1,300	1,000	--	--	--
Aluminum	--	--	107 B	246	51 B
Beryllium	4.0	--	--	--	--

TABLE 1-13 (Continued)

DETECTED INORGANIC CONTAMINANTS IN GROUNDWATER
 RI SCOPING INVESTIGATION
 SITE 43, AGAN STREET DUMP
 REMEDIAL INVESTIGATION, CTO-0303
 MCAS, NEW RIVER, NORTH CAROLINA

Contaminant	Federal ⁽¹⁾ MCL (µg/L)	NCWQS ⁽²⁾ (µg/L)	Well Number		
			43-GW01	43-GW02	43-GW03
Cobalt	--	--	--	--	--
Metals (Dissolved) (µg/L) (continued):					
Magnesium	--	--	1,810 B	1,870 B	3,670 B
Nickel	100	150	--	--	--
Manganese	50	50	43.4	18.6	46.3
Zinc	5,000	5,000	43.5	35.1	14.9 B
Vanadium	--	--	--	--	--
Sodium	--	--	8,870	10,400	7,990
Potassium	--	--	3,030 B	--	1,960 B
Iron	300	300	29.5 B	752	1,410
Calcium	--	--	50,800	2,290 B	26,300
Silver	100	50	--	--	--
Lead	15	50	23	20.1	15
Chromium	100	50	--	--	--
Antimony	6.0	--	16.4 B	--	--

Notes:

Concentrations reported in micrograms per liter (µg/L); or parts per billion ppb).

J - Estimated value, reported value may not be accurate or precise.

ND - Not Detected

DUP - Duplicate

(--)- Standard or criteria not available.

⁽¹⁾ National Primary Drinking Water Regulations, Primary Maximum Contaminant Levels (MCLs)

⁽²⁾ North Carolina Water Quality Standards for Groundwater (NCAC, 1993)

⁽³⁾ Health Advisories (USEPA, 1993), values represent lifetime exposures, except for arsenic and beryllium which represents 10-04 lifetime risk.

Source: Baker Environmental, Inc. Site Inspection Report, 1991.

TABLE 1-14

**REMEDIAL INVESTIGATION OBJECTIVES
SITE 43, AGAN STREET DUMP
REMEDIAL INVESTIGATION, CTO-0303
MCAS, NEW RIVER, NORTH CAROLINA**

Medium or Area of Concern	RI/FS Objective	Criteria for Meeting Objective	Proposed Investigation/Study
1. Soil	1a. Assess the extent of soil contamination within suspected disposal areas.	Characterize contaminant levels in surface and subsurface soils at Site 43.	Soil Investigation
	1b. Assess human health and ecological risks associated with exposure to surface soils at the site.	Characterize contaminant levels in surface soils at the study area.	Soil Investigation Risk Assessment
	1c. Determine the physical and chemical nature of buried debris and/or waste.	Characterize the physical and chemical nature of buried debris and/or waste.	Test Pit Investigation
2. Groundwater	2a. Determine whether soil contamination is migrating to groundwater.	Characterize groundwater quality within the suspected disposal areas.	Groundwater Investigation
	2b. Assess health risks posed by potential future usage of the shallow and deep groundwater.	Evaluate groundwater quality and compare to groundwater criteria and risk-based action levels.	Groundwater Investigation Risk Assessment
	2c. Assess nature and extent of shallow and deep groundwater contamination.	Characterize shallow and deep groundwater quality.	Groundwater Investigation
	2d. Define hydrogeologic characteristics for fate and transport evaluation and remedial technology evaluation, if required.	Estimate hydrogeologic characteristics of the shallow and deep aquifers (flow direction, transmissivity, permeability, etc.).	Groundwater Investigation

TABLE 1-14 (Continued)

**REMEDIAL INVESTIGATION OBJECTIVES
SITE 43, AGAN STREET DUMP
REMEDIAL INVESTIGATION, CTO-0303
MCAS, NEW RIVER, NORTH CAROLINA**

Medium or Area of Concern	RI/FS Objective	Criteria for Meeting Objective	Proposed Investigation/Study
3. Surface Water	3a. Assess the presence or absence of surface water contamination in Edwards Creek and Strawhorn Creek.	Determine surface water quality in Edwards Creek and Strawhorn Creek.	Surface Water Investigation
	3b. Assess potential ecological impacts posed by contaminated surface water in Edwards Creek and Strawhorn Creek.	Determine surface water quality in Edwards Creek and Strawhorn Creek.	Surface Water Investigation Evaluation of Bioassay Results
4. Sediment	4a. Assess human health and ecological risks associated with exposure to sediments in Edwards Creek and Strawhorn Creek.	Characterize nature and extent of contamination in sediment.	Sediment Investigation in Edwards Creek and Strawhorn Creek Risk Assessment
	4b. Assess potential ecological impacts posed by contaminated sediments in Edwards Creek and Strawhorn Creek.	Qualitatively evaluate stress to benthic and fish communities.	Sediment Investigation Evaluation of Bioassay Results
	4c. Determine extent of sediment contamination for purposes of identifying areas of concern.	Identify extent of sediment contamination where contaminant levels exceed risk-based action levels or USEPA Region IV criteria.	Sediment Investigation in Edwards Creek and Strawhorn Creek Risk Assessment

SECTION 1.0 FIGURES

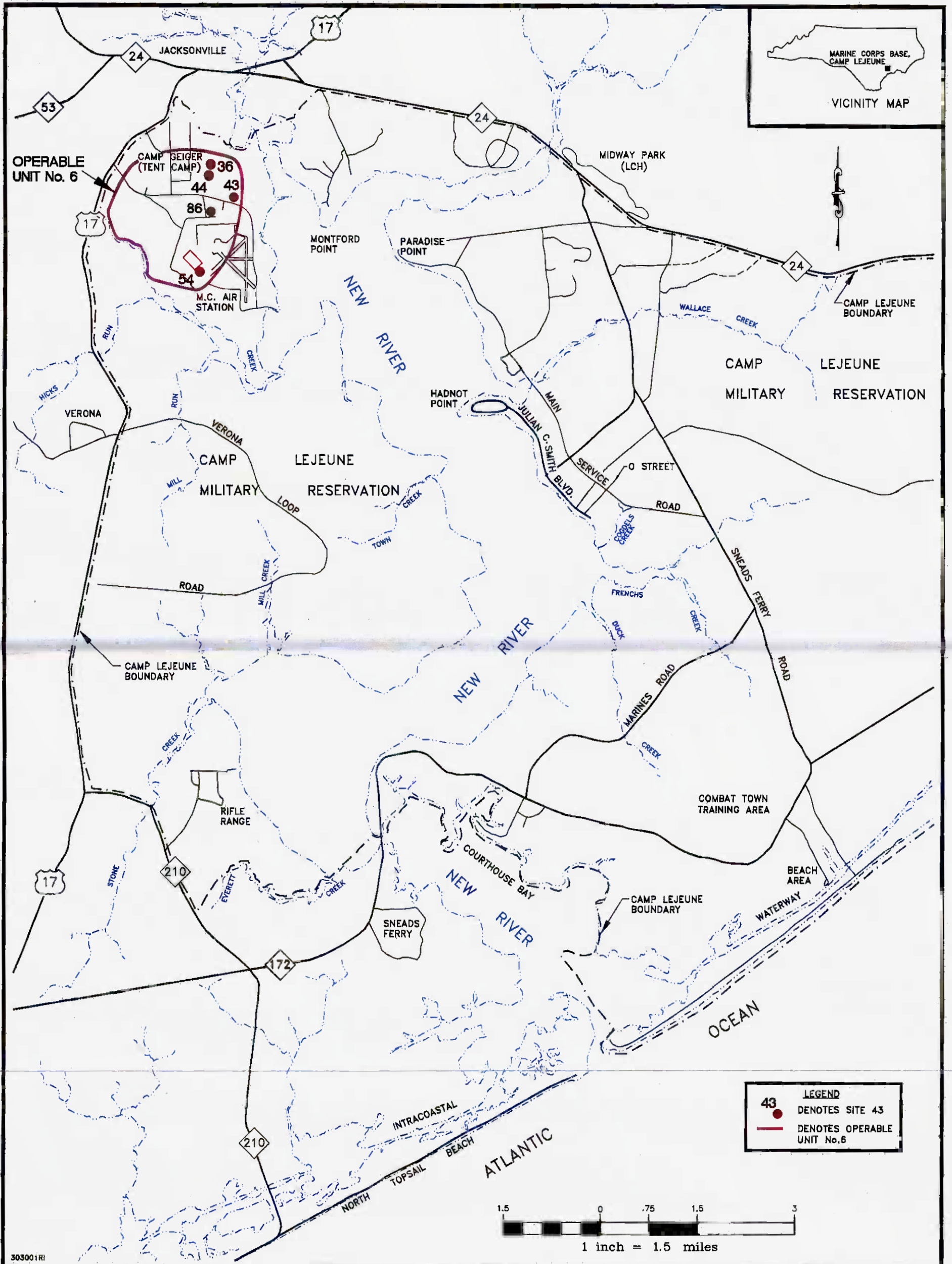


FIGURE 1-1
 OPERABLE UNIT No. 6 - SITES 36, 43, 44, 54, AND 86
 REMEDIAL INVESTIGATION, CTO-0303

MARINE CORPS AIR STATION, NEW RIVER
 NORTH CAROLINA

01713YBIY

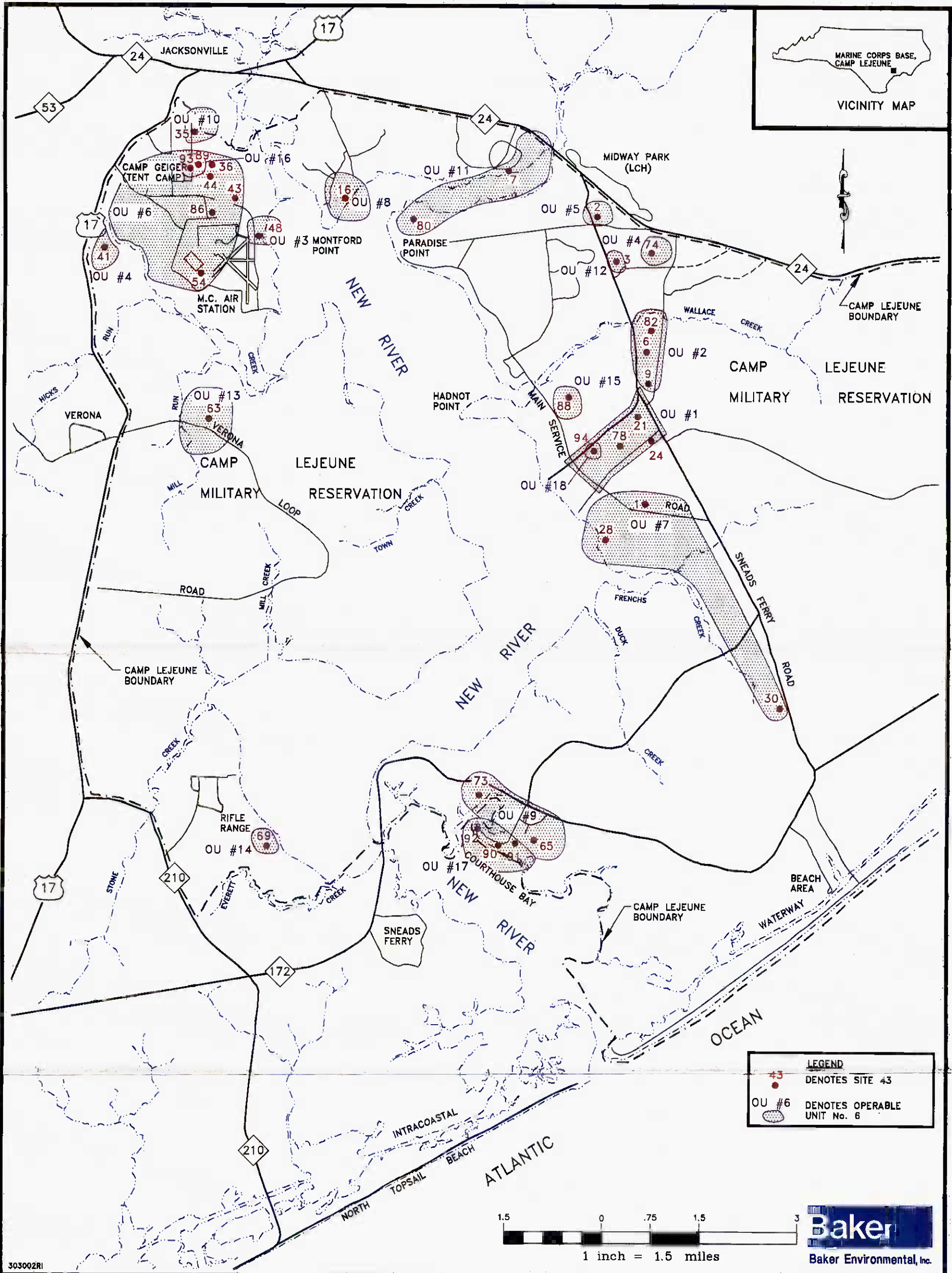


FIGURE 1-2
OPERABLE UNIT AND SITE LOCATIONS
REMEDIAL INVESTIGATION, CTO-0303

MARINE CORPS BASE, CAMP LEJEUNE
NORTH CAROLINA

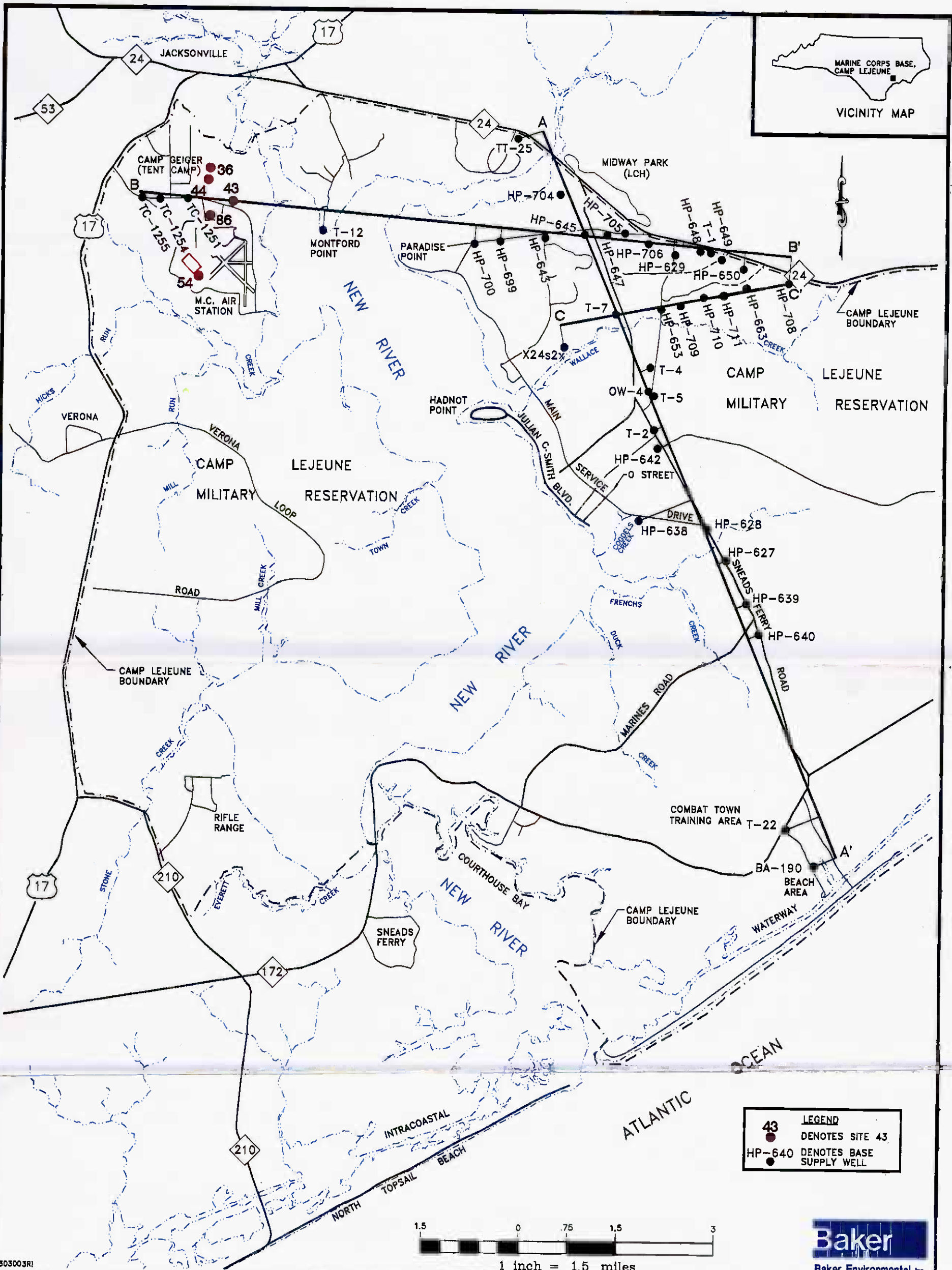
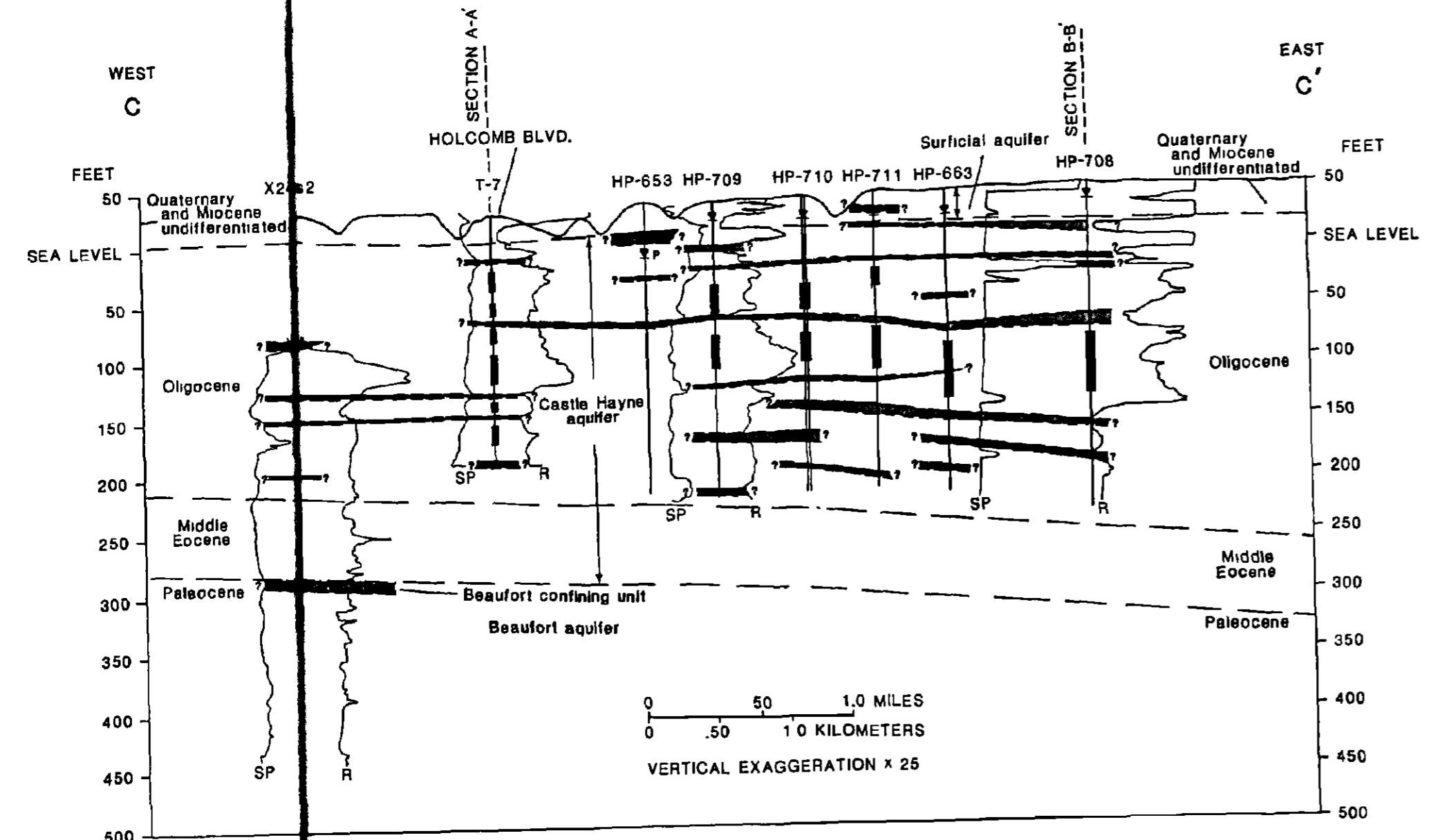
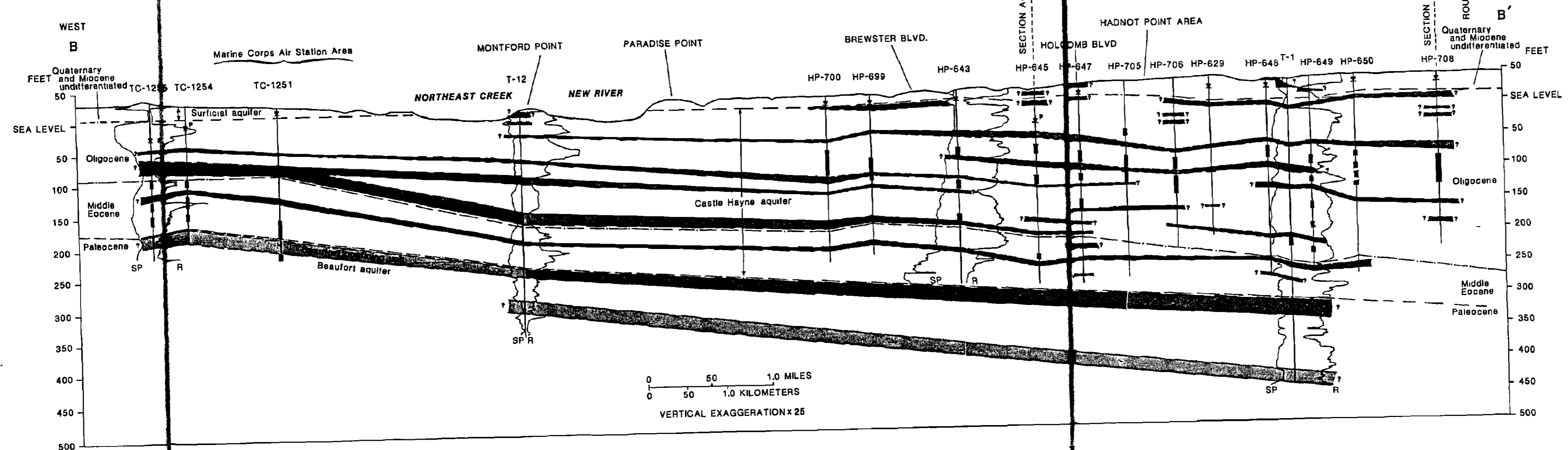
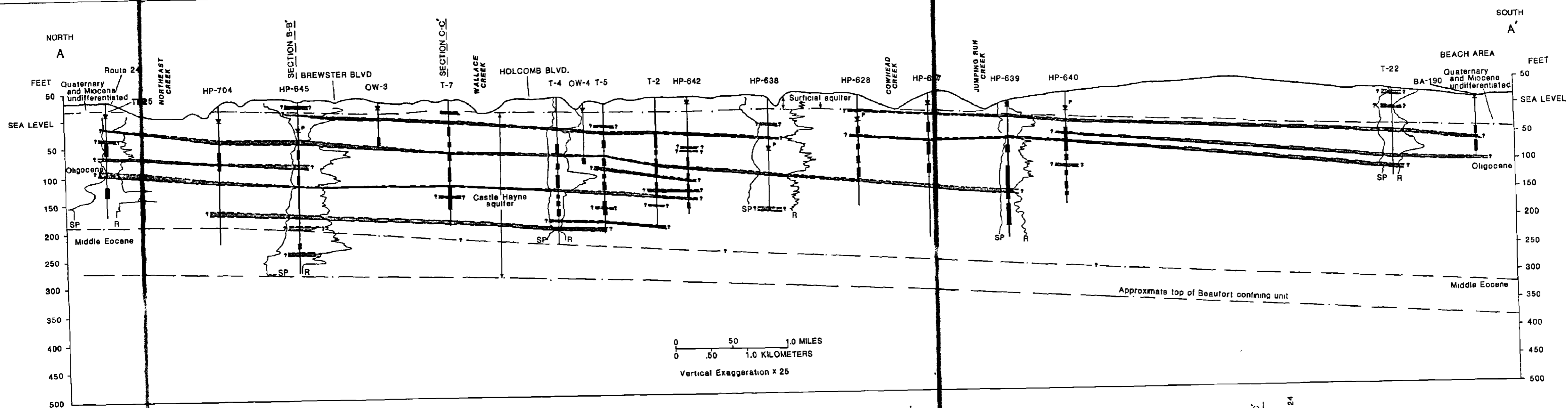


FIGURE 1-3
 LOCATIONS OF HYDROGEOLOGIC CROSS-SECTIONS
 REMEDIAL INVESTIGATION, CTO-0303

MARINE CORPS AIR STATION, NEW RIVER
 NORTH CAROLINA

SOURCE: DEPT. OF INTERIOR,
 WATER-RESOURCES INVESTIGATIONS
 REPORT, 89-4096, PLATE 4

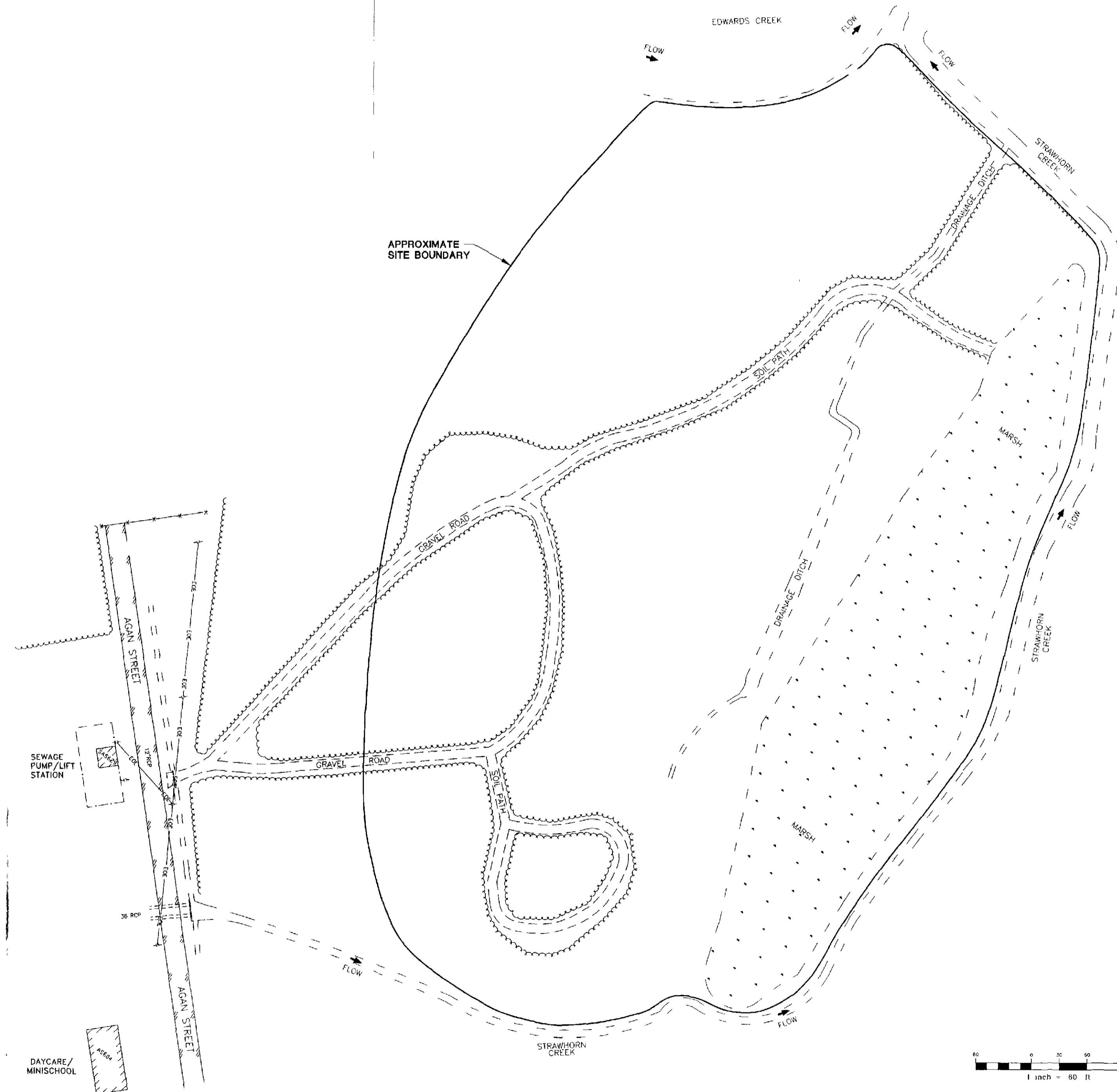


- EXPLANATION**
- HP-645 WELL NUMBER
 - GEOLOGIC TIME LINE
 - WATER LEVEL, OCTOBER 1986
p. denotes pumping water level
 - SCREEN
 - HYDROGEOLOGIC UNITS
 - Potential confining unit. Quoted where lateral extent uncertain
 - Potential aquifer unit
 - GEOPHYSICAL LOG TRACE
 - SP, denotes spontaneous potential log
 - R, denotes resistivity log
- HYDROGEOLOGIC SECTIONS LOCATED ON PLATE 4

FIGURE 1-4
 HYDROGEOLOGIC CROSS-SECTIONS
 REMEDIAL INVESTIGATION, CTO-0303
 MARINE CORPS BASE, CAMP LEJEUNE
 NORTH CAROLINA

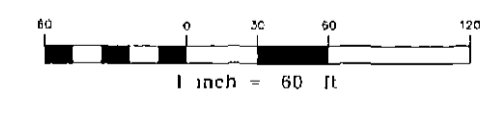
HYDROGEOLOGIC SECTIONS A-A', B-B', AND C-C' AT CAMP LEJEUNE, NORTH CAROLINA

017134 B2X



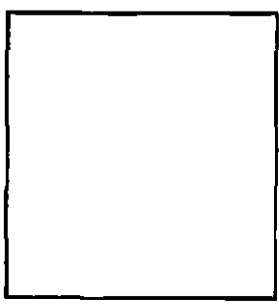
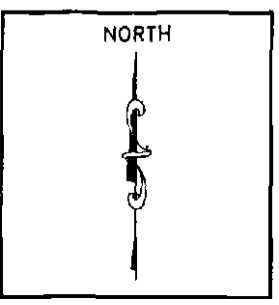
LEGEND

- FLOW DIRECTION OF SURFACE WATER FLOW
- MARSH
- OVERHEAD ELECTRIC LINE & UTILITY POLE
- FENCE
- ASPHALT ROAD
- GRAVEL ROAD OR SOIL PATH
- EDGE OF CREEK, DRAINAGE DITCH, MARSH OR POND
- TREE LINE
- STRUCTURE



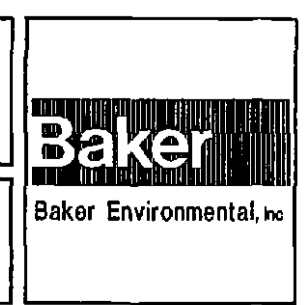
REVISIONS	

DRAWN	REL
REVIEWED	TFT/JEZ
S.O.#	62470-303-0000-07000
CADD#	303005RI



REMEDIAL INVESTIGATION CTO-0303
MARINE CORPS AIR STATION, NEW RIVER
NORTH CAROLINA

BAKER ENVIRONMENTAL, Inc.
Coraopolis, Pennsylvania

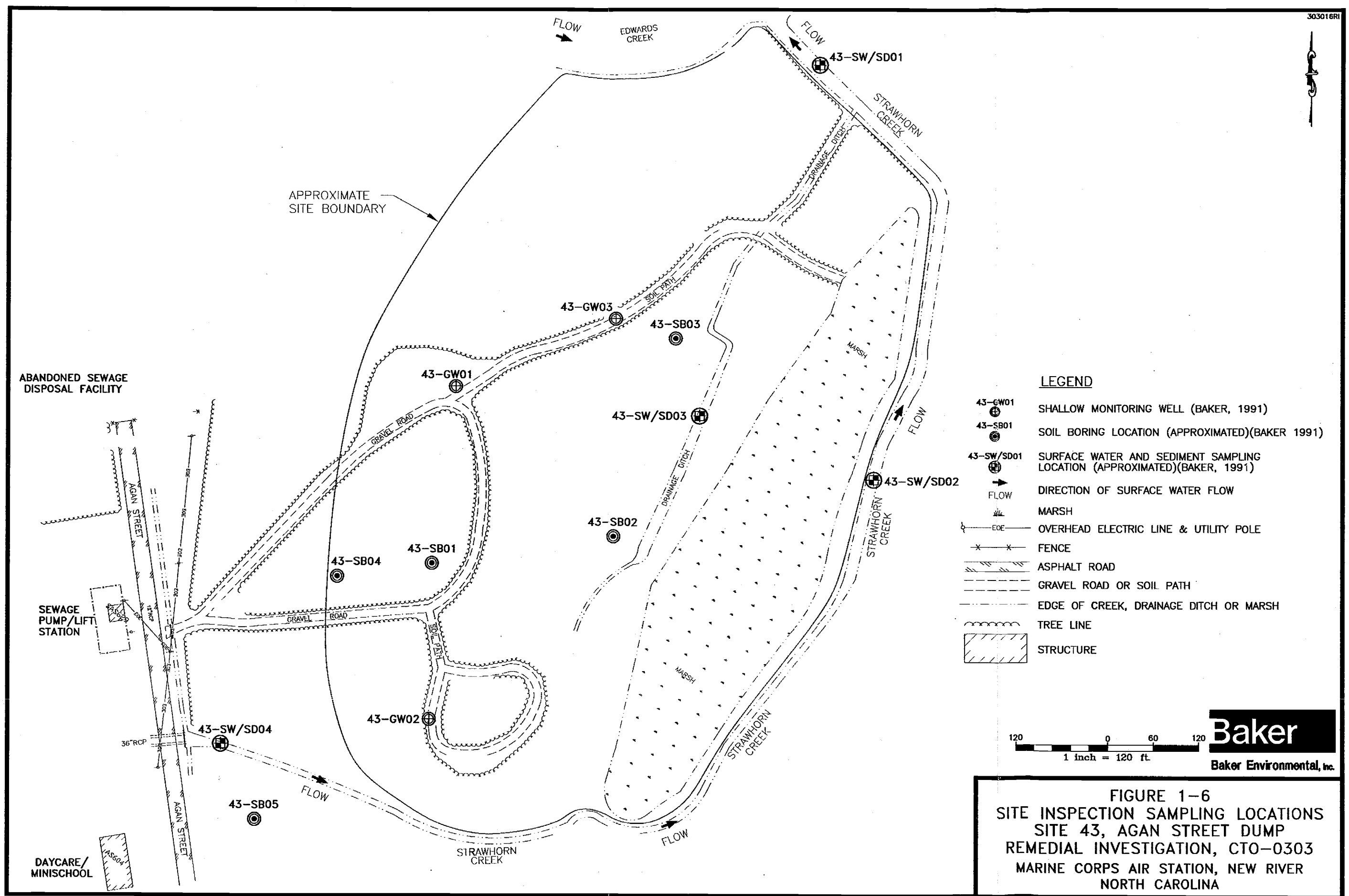


SITE MAP SITE 43, AGAN STREET DUMP	
SCALE	1" = 60'
DATE	JANUARY 1996

FIGURE No
1-5

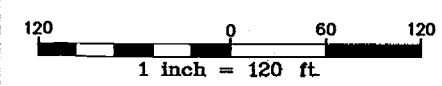
SOURCE LANTDIV, FEBRUARY 1992
SURVEY BRENT A. LANIER AND ASSOCIATES, 1995

24200 1/4" X 36" (2000) PLOT (10) 5/11/96 10:00 AM (10) 5/11/96 10:00 AM



LEGEND

- 43-GW01 SHALLOW MONITORING WELL (BAKER, 1991)
- 43-SB01 SOIL BORING LOCATION (APPROXIMATED)(BAKER 1991)
- 43-SW/SD01 SURFACE WATER AND SEDIMENT SAMPLING LOCATION (APPROXIMATED)(BAKER, 1991)
- FLOW DIRECTION OF SURFACE WATER FLOW
- MARSH
- OVERHEAD ELECTRIC LINE & UTILITY POLE
- FENCE
- ASPHALT ROAD
- GRAVEL ROAD OR SOIL PATH
- EDGE OF CREEK, DRAINAGE DITCH OR MARSH
- TREE LINE
- STRUCTURE



Baker
Baker Environmental, Inc.

FIGURE 1-6
SITE INSPECTION SAMPLING LOCATIONS
SITE 43, AGAN STREET DUMP
REMEDIAL INVESTIGATION, CTO-0303
MARINE CORPS AIR STATION, NEW RIVER
NORTH CAROLINA

017134012

2.0 SITE CHARACTERISTICS

Section 2.0 of this report presents information on site-specific physical characteristics. This section includes a discussion on the topography, surface water hydrology and drainage features, geology, hydrogeology, ecology.

2.1 Topography and Surface Features

Site 43 is a primarily wooded area with a few open areas. The site slopes very gently from the west to the northeast, east and southeast, toward Strawhorn Creek/marsh area. A general surface topography is presented of Figure 2-1. The elevation of the site ranges from a low of approximately 3 feet above mean sea level (msl) near the creek, to about 7 feet above msl near 43-GW04. The small rise evident on the figure between 43-GW01 and 43-TP02 represents an elongated mound that appears to have been built up from the original ground surface. Based on field observations, the mound trends southwest to northeast, passing through 43-TP01, TP02, and diminishes in elevation towards TP03.

2.2 Surface Water Hydrology

Surface water movement is limited at Site 43 due to the subdued topography, low elevation, and woodlands. At the time of the investigation, ponded water and saturated soils were observed throughout much of the site. Much of the northeastern portion of the site that borders the creek was flooded. Roadway drainage ditches did not appear to move water effectively. Standing water was evident in most ditches throughout the investigation.

2.3 Soil

According to the Soil Conservation Service (SCS) Soil Survey of Camp Lejeune, North Carolina (1984), a single unit lies under Site 43, the Baymeade (BaB) soil complex. The Baymeade complex is typically found in areas where the original soil has been cut, filled, or graded. Soil properties of this unit have been altered through slope modification and smoothing. Generally, Baymeade soils are moderately to strongly acidic and are classified under the SCS as fine sand and loamy fine sand (SM-SP). Table 2-1 provides a summary of soil physical properties found at Site 43.

2.4 Geology

A depositional sequence was observed in the deep well borings at Site 43 that matches the sequence discussed in the U.S. Geological Survey's hydrogeologic assessment of Camp Lejeune (Cardinell, et al., 1993). The uppermost formation at Site 43 called is the undifferentiated formation. The Belgrade Formation lies below, with the River Bend Formation below that.

Debris and fill/regraded soil is on the surface at Site 43. Test pits excavated into soil mounds revealed soil containing miscellaneous debris including metal straps, metal containers, bricks, and plastic. The materials are believed to be associated with the disposal of construction debris from the nearby housing area. Note that the debris were not containerized during the test pit operations because the materials unearthed remained within the trench and were not brought to the surface.

The uppermost formation at Site 43, the undifferentiated formation is comprised of two units of Holocene and Pleistocene ages. This formation extends to a depth between 33 and 38 feet bgs. The

upper unit consists of a fine sand with lesser amounts of medium and coarse sand, silt and clay. This unit is approximately 20 feet thick, and tends to be loose to medium dense. A fine to medium sand with a lesser amount of shell fragments and silt lies below the upper sand. This fine to medium sand unit is 12 to 18 feet thick, and tends to be medium dense to dense. Lenses of silts and clays were sporadically encountered in the undifferentiated formation.

The Belgrade Formation, is comprised of fine sand, with lesser amounts of silt and clay of the Miocene age. The top of this Formation lies 33 to 38 feet bgs, is approximately 16 feet thick, and has a distinct green or greenish-gray color. The sediments of this formation are medium dense to dense.

The River Bend Formation is comprised of fine sand, with lesser amounts of shell fragments and silt of the Oligocene age. This Formation lies 50 to 55 feet bgs at Site 43, and tends to be very dense.

Geologic cross-sections depicting the shallow and deep sediment lithologies were developed based on soils collected during the RI. Boring logs are provided in Appendix A and well boring and construction logs are provided in Appendix B. Test pit logs appear in Appendix C. Figure 2-1 shows locations of the cross-sections traversing Site 43 and Figure 2-2 depicts lithologies. Most wells and borings at Site 43 are shallow. Cross-sections B-B', C-C', D-D', and E-E' show only the upper portion of the undifferentiated formation.

Section A-A' traverses southwest to northeast across Site 43. The upper sand varies in composition, from and fine sand and silt, or silty clay to a fine to coarse sand, some gravel. Groundwater occurs within 3 feet of the surface in this sand unit. The lower sand unit is generally more coarse-grained than the sand above it. The fine-grained Belgrade Formation is appears to contain less water than the sand units above it. The Belgrade Formation appears to be inhibiting downward groundwater movement, due to the lack of moisture observed in split-spoon samples.

Section B-B' traverses northwest to southeast across Site 43. A medium sand is predominant in the upper portion of the undifferentiated formation. A silt and fine sand lies below the medium sand. Groundwater occurs within 2 feet of the surface at lower elevations.

Section C-C' traverses south to north across Site 43. A fine sand with lesser amounts of silt and clay is predominant in the upper undifferentiated formation. The composition does not vary significantly. Two small clayey lenses are present along this section. Groundwater occurs within 5 feet of the surface.

Cross-section D-D' traverses south to north across the site. A medium sand is predominant along the northern portion of the section, and a fine sand is predominant along the southern portion of the section. Groundwater occurs within 3 feet of the surface.

Cross-section E-E' traverses west to east across the site. A fine sand is predominant, however a wedge of fine to medium sand is present along the eastern portion of the section. Both sands contain lesser amounts of silt and clay. Groundwater occurs within 2 feet of the surface.

2.5 Hydrogeology

There are several aquifers beneath Site 43 and vicinity. The upper two aquifers were investigated in this study, namely the surficial and Castle Hayne. The surficial aquifer, which is unconfined (i.e.,

water table aquifer), occurs within the sediments of the undifferentiated formation. The surficial aquifer typically lies within 5 feet of the surface, and is 30 to 37 feet thick in the vicinity of Site 43. The upper portion of the Castle Hayne aquifer lies within the sediments of the River Bend Formation. The Castle Hayne aquifer lies 50 to 55 feet bgs, and is approximately 200 feet thick in the vicinity of Camp Gieger and the Air Station (Cardinell et al., 1993). The Belgrade Formation, situated between the undifferentiated and River Bend Formations is also known as the Castle Hayne confining unit. The Castle Hayne confining unit is approximately 16 feet thick in the vicinity of Site 43.

The hydrogeologic conditions were evaluated by installing a network of shallow and deep monitoring wells. Three staff gauges were located in Strawhorn Creek to monitor surface water elevations.

2.5.1 Groundwater Elevation Data

Groundwater and creek elevation data for Site 43 are summarized on Table 2-2. Three rounds of groundwater level measurements were collected in March, April, and May of 1995. Two rounds of water level data is available for the staff gauges because of the installation timing.

Shallow monitoring wells are screened to intercept the water table and average a depth of approximately 13 feet bgs. The deep wells are screened immediately below the Castle Hayne confining unit, to monitor the upper portion of the Castle Hayne aquifer. The deep wells average depth is approximately 63 feet bgs.

The groundwater elevation data from all wells exhibit a downward trend between March and May (Figure 2-3A and B). The decrease in elevation ranged from approximately 1.2 to 2.8 feet. The average groundwater elevation decrease in the shallow wells was 2.2 feet. The average groundwater elevation decrease in the deep wells was 1.2 feet. This trend is likely attributable to the lack of rain during the time period.

Well nest 43-GW04/04DW exhibited a consistent downward flow potential (Figure 2-3B). The groundwater elevation was consistently higher in the shallow well. No consistent trend was observed in well nest 43-GW01/01DW.

2.5.2 Groundwater Flow Contour Maps

Groundwater elevation contour maps were developed from static water level data collected between March and May of 1995. The surficial groundwater flow direction and gradient were fairly consistent between March and May. A surficial aquifer groundwater contour map is presented as Figure 2-4 using May 1995 data. Since only two deep wells were installed, Castle Hayne groundwater maps were generated using the two deep wells at near-by Site 44. Three wells are typically required at a minimum to generate accurate groundwater contour maps for determining flow direction. Accordingly, the presentation of the data is intended for general discussion purposes only. Groundwater flow patterns were consistent between March and May. A Castle Hayne groundwater contour map is presented as Figure 2-5 using May 1995 data. Flow gradients were determined by dividing a certain distance of a flow line (or distance between two wells) into the change in groundwater elevation over that distance (Appendix O). The gradient may vary slightly from month to month due to changes in groundwater elevations.

Shallow groundwater flow across Site 43 is east and southeast. The groundwater flow gradient is fairly consistent across the site at approximately 0.004 feet/foot. Based on groundwater flow direction groundwater elevation relative to the creek elevation, it appears that the surficial aquifer discharges to Strawhorn Creek.

Groundwater flow in the upper portion of the Castle Hayne aquifer is to the east between Site 43 and 44. The flow gradient is approximately 0.001 feet/foot to 0.002 feet/foot. Flow direction is toward the New River.

2.5.3 Hydraulic Properties

Rising and falling head slug tests were conducted at Site 43 on several shallow and deep monitoring wells. The slug test data were analyzed using the Bower-Rice method on AQTESOLV Version 2.0 software. The solutions are presented in Appendix N and summarized on Table 2-3.

Rising head test data is used in the text discussions. Falling head test data was used where available, as a check against the rising head data. The falling head test is equally valid to the rising head test when the static water level is above the screen interval and, therefore, was only evaluated for the deep monitoring wells.

The sediments of the surficial aquifer tend to be fine grained. These sediments exhibit hydraulic conductivities on the order of 1.0 to 9.9 feet/day, typical for such fine grained sediments. The hydraulic conductivity values vary from well to well. This likely due to the varying composition of the surficial aquifer.

Hydraulic conductivity values varied in the Castle Hayne aquifer. The hydraulic conductivity at 43-GW01DW was measured to be approximately 59.3 feet/day, and 8.8 feet/day at 43-GW04DW. Again, the hydraulic conductivity values vary, due to the varying lithologic composition.

Transmissivity is the hydraulic conductivity multiplied by the saturated thickness of the aquifer. The calculated transmissivity of the Castle Hayne aquifer is one to two orders of magnitude higher than the surficial aquifer. This is because the thickness of the Castle Hayne is 200 feet compared to a 35 foot saturated thickness of the surficial aquifer. Also, the average hydraulic conductivity of the Castle Hayne is higher than in the surficial aquifer.

The surficial aquifer hydraulic conductivity values are on the same order of magnitude as the value presented in the Cardinell (1993) report. The average hydraulic conductivity at Site 43, based on RI slug tests is 16.1 feet/day, compared to 50 feet/day presented by Cardinell. Cardinell provided an estimated hydraulic conductivity value of 50 feet/day based on a general composition of fine sand, mixed with some silt and clay. The average hydraulic conductivity and transmissivity for the Castle Hayne at Site 43 is 34.1 feet/day and 6,810 feet²/day, respectively. Cardinell's report presents hydraulic conductivities and transmissivities from several studies. Hydraulic conductivities range from 14 to 91 feet²/day and transmissivities range from 820 to 26,000 feet²/day. The RI results for Site 43 are comparable with other sites throughout Camp Lejeune.

Geotechnical analyses, including particle size analysis and vertical hydraulic conductivity was determined for a sample of the Castle Hayne confining unit (Appendix M). The sample was taken via Shelby-tube from 36 to 37.5 feet bgs at well boring 43-GW01DW. This sample was determined

to be a clayey fine sand with a vertical permeability of 1.4×10^{-7} cm/sec, or 0.0004 feet/day. The vertical permeability suggests that infiltration is slow through the Castle Hayne confining unit.

2.5.4 Groundwater Flow Velocities

Groundwater flow velocities can be estimated using a variation of Darcy's equations:

$$V = Ki/n_e$$

where; V = groundwater velocity (feet/day)
 K = Hydraulic conductivity (feet/day)
 i = horizontal gradient (feet/foot)
 n_e = effective porosity

"K" values were determined from slug tests conducted at wells 43-GW01, 43-GW02, 43-GW04, 43-GW01DW, and 43-GW04DW. Surficial aquifer hydraulic conductivity values ranged from 1.0 feet/day at 43-GW01 to 9.9 feet/day at 36-GW04. Castle Hayne aquifer hydraulic conductivity values were 8.8 feet/day at 43-GW04DW and 59.3 feet/day at 43-GW01DW. Flow gradient values were determined by using groundwater contours (Section 2.5.3). An effective porosity value of 30% was used (Fetter, 1988), based on the silty sands underlying the site. Velocity calculations are presented in Appendix O. Velocities may vary slightly from month to month due to varying gradients.

The calculated groundwater flow velocities of the surficial varied by an order of magnitude across the site, ranging from 0.03 feet/day to 0.33 feet/day. The highest velocity observed is at 43-GW04. This is directly related to a hydraulic conductivity that is nearly an order of magnitude higher than the other wells.

The calculated groundwater flow velocities for the Castle Hayne were 1.19 feet/day at 43-GW01DW and 0.18 feet/day at 43-GW04DW. This order of magnitude difference is directly related to hydraulic conductivity. Note that these velocities are an estimate due to the fact that only two points were used to calculate the groundwater gradient. Three points are desirable for determining the gradient.

2.5.5 General Groundwater Flow Patterns

Groundwater flow in the surficial aquifer at Site 43 is toward Strawhorn Creek and the marshland to the east, with an average velocity of 0.13 feet per day. Groundwater flow in the upper Castle Hayne aquifer is also to the east, with an average velocity of 0.69 feet/day. Because the hydraulic conductivity varies, groundwater may exhibit preferential flow paths following the relatively highly conductive medium and coarse sands.

The surficial and Castle Hayne aquifers underlying Site 43 are separated by the Castle Hayne confining unit. This confining unit consists of fine sand with lesser amounts of silt and clay, and is approximately 16 feet thick. There appears to be some degree of leakage between the two aquifers. A vertical hydraulic conductivity of 0.0004 feet/day was measured in a sample from the Castle Hayne confining unit on well 43-GW01DW. This rate suggests slow vertical infiltration through the confining unit at this particular location. The elevation trends between March and May

in the surficial and Castle Hayne aquifers are similar, although the change in the Castle Hayne was less.

It appears that groundwater in the surficial aquifer at Site 43 discharges to the Strawhorn Creek. This is based on the elevation of the creek relative to groundwater elevations and groundwater flow direction. It appears that groundwater in the Castle Hayne aquifers flows underneath Strawhorn Creek, and may discharge to the New River and/or the adjacent marsh area. This is based on the groundwater flow direction and consistent gradient. Groundwater elevation data compiled and mapped by Cardinell indicate that groundwater in the Castle Hayne aquifer flows toward, and discharges to the New River and its major tributaries.

2.6 Identification of Water Supply Wells

Potable water supply wells within a one-mile radius of the site were identified by reviewing the Wellhead Management Program Engineering Study (Geophex, Ltd., 1991) document. Four water supply wells were identified within the one-mile radius. Three of the four wells were reported to be operating. Table 2-4 summarizes some well construction details and Figure 2-6 shows the location of the supply wells. These supply wells are located upgradient of Site 43 based on their location with respect to easterly groundwater flow direction in the Castle Hayne.

The three operating supply wells were sampled in 1992 (Greenhorne & O'Mara, 1992). Detected compounds are presented on Table 2-4. No organic compounds were detected in any of the wells listed. Several inorganic analytes were detected. The USEPA has established secondary maximum concentration limits (SMCLs) for several analytes detected. North Carolina has also established standards for several of the analytes detected. The Aluminum SMCL was exceeded in two wells sampled. Aluminum was not detected in MCAS-131. The iron, manganese, and TDS SMCL/Standards were exceeded all wells, except for manganese in well MCAS-203.

Aluminum, iron, and manganese appear to be prevalent across Camp Lejeune. The presence of aluminum, iron and manganese in water supply wells at these concentrations appears to be representative of base-wide conditions.

2.7 Ecology

Two types of wetlands are present at Site 43. Along Strawhorn Creek on the eastern side of the site an estuarine, intertidal, scrub-shrub, broad-leaved deciduous, irregularly flooded wetland is present. The National Wetlands Inventory (NWI) maps also identify a palustrine, forested, broad-leaved deciduous, temporarily flooded, ditched wetland in the vicinity of the site. This type of wetland can be found along Strawhorn Creek south of the site, along the drainage ditch running parallel to Strawhorn Creek along the eastern edge of the site, and along the drainage ditch to Strawhorn Creek north of the site.

Apart from the wetlands, no sensitive environments were identified at Site 43 studied during this remedial investigation. No endangered species were noted during the habitat evaluation nor were endangered species referenced at any of the sites during the endangered species survey (LeBlond, 1994).

Most of the area in the vicinity of the Agan Street Dump is covered by mixed forest that grades to swamp along the creek and its tributaries and drainage areas. Disposal areas and the borders of the access roads are more open. Figure 2-7 shows a biohabitat map for the Site 43 area.

The mixed forest is dominated by loblolly pine (*Pinus taeda*) in the canopy. Deciduous trees, including water oak (*Quercus nigra*), sweetgum (*Liquidambar styraciflua*), tulip poplar (*Liriodendron tulipifera*), sourwood (*Oxydendrum arboreum*), and honeylocust (*Gleditsia tricanthos*), are intermixed with the pines. None of the saplings, shrubs, or vines in the understory is dominant. Species present include the following:

- Myrtle- *Myrica cerifera*
- Juniper- *Juniperus virginianus*
- Rosebay- *Persea borbonia*
- Blueberry- *Vaccinium* sp.
- Olive- *Elaeagnus pungens*
- Greenbriar- *Smilax rotundifolia*
- Japanese Honeysuckle- *Lonicera japonica*

Little vegetation is present on the floor of this mixed forest. Partridgeberry (*Mitchella repens*), spotted wintergreen (*Chimaphila maculata*), and ebony spleenwort (*Asplenium platyneuron*) were identified during the habitat evaluation.

The mixed forest is replaced by swamp in the areas of lower elevation and along the creek and its tributaries. No specie of tree is dominant in this swamp, which includes the following:

- Red maple- *Acer rubrum*
- Sweetgum- *Liquidambar styraciflua*
- Water Oak- *Quercus nigra*
- Swamp Chestnut Oak- *Quercus michauxii*
- Sourwood- *Oxydendrum arboreum*

Although the swamp includes some of the same trees that are present in the mixed forest, the trees in the swamp have developed buttressed trunks and surface roots in response to the damp habitat. The understory of the swamp is dominated by two shrubs: redbay (*Persea borbonia*) and fetterbush (*Lyonia lucida*). These shrubs form dense areas of undergrowth in some areas of the swamp. Other shrubs present include myrtle (*Myrica cerifera*), juniper (*Juniperus virginianus*), and dangleberry (*Gaylussacia frondosa frondosa*). No vines are present in the understory of the swamp.

In contrast to the mixed forest, vegetation is more widespread on the floor of the swamp. Species identified are typical of wooded wetlands and include

- Switch Cane- *Arundinaria tecta*
- Swamp Dock- *Rumex verticillatus*
- Arrow Arum- *Peltandra virginica*
- Cattail- *Typha latifolia*
- Jack-in-the-Pulpit- *Arisaema triphyllum*

An small open area is present at Site 43. Three species of trees, all of which were saplings or young trees, are growing in the open area. These include loblolly pine (*Pinus taeda*), mulberry (*Morus*

rubra), and honeylocust (Gleditsia tricanthos). Vines of dewberry (Rubus flagellaris) and Japanese honeysuckle (Lonicera japonica) are also present with grasses and herbaceous annuals and perennials. The following forbs were identified in the open area:

- Blue Flag- Iris verna
- Dogfennel- Eupatorium capillifolium
- White Clover- Trifolium repens
- Curly Dock- Rumex crispus
- St. Peterswort- Hypericum stans

A number of birds were observed at Site 43 during the habitat evaluation. Most of these are permanent residents and include the following species:

- Downy Woodpecker- Picoides pubescens
- Tufted Titmouse- Parus bicolor
- Myrtle Warbler- Dendroica coronata
- Carolina Chickadee- Parus carolinensis
- Carolina Wren- Thryothorus ludovicianus
- Yellow Warbler- Dendroica petchia
- Grackle- Quiscalus quiscula

Although no mammals were observed during the habitat evaluation, mammals are present at the site, as evidenced by the signs that were observed. Tracks of whitetail deer (Odocoileus virginianus), feeding areas of skunks (Mephitis mephitis) and squirrels (Sciurus carolinensis), and droppings of rabbits (Sylvilagus floridanus) were identified.

Three species of reptiles and amphibians were observed at Site 43 during the habitat study. An anole (Anole carolinensis) was noted in the mixed forest and both green frogs (Rana clamitans) and carpenter frogs (Rana virgatipes) were identified in the drainage ditches and in the swamp.

2.8 References

Barnhill, W.L. 1984. Soil Survey of Camp Lejeune, North Carolina. USDA, Soil Conservation Service.

Cardinell, A.P., Berg, S.A., and Lloyd O.B. Jr. 1993. Hydrogeologic Framework of U.S. Marine Corps Base at Camp Lejeune, North Carolina. USGS. Water-Resources Investigations Report 93-4049.

Fetter, C.W. 1986. Applied Hydrogeology. Charles E. Merrill Publishing Co., Columbus, Ohio.

Geophex, Ltd. 1992. Wellhead Management Program Engineering Study 91-36. Prepared for Marine Corps Base, Camp Lejeune, North Carolina. January 22, 1992.

Greenhorne & O'Mara. 1992. Preliminary Draft Report Wellhead Monitoring Study. Prepared for the Department of the Navy, Civil Branch. December, 1992.

Harned, D.A., Lloyd, O.B., Jr., and Treece, M.W., Jr. 1989. Assessment of Hydrologic and Hydrogeologic Data at Camp Lejeune Marine Corps Base, North Carolina. USGS. Water-Resources Investigations Report 89-4096.

LeBlond, Richard. 1991. Critical Species List - Camp Lejeune Endangered Species and Special-Interest Communities Survey. Principal Investigator.

SECTION 2.0 TABLES

TABLE 2-1

SUMMARY OF SOIL PHYSICAL PROPERTIES AT SITE 43
 REMEDIAL INVESTIGATION CTO - 0303
 MCAS, NEW RIVER, NORTH CAROLINA

Soil Name	Soil Symbol	USCS Classification	Depth (inches)	Moist Bulk Density (g/cc)	Permeability (cm/s)	Soil Reaction (pH)	Shrink-Swell Potential	Organic Matter (percent)
Baymeade-Urban	BaB	SM, SP-SM	0 - 30	1.60 - 1.75	4.2×10^{-3} - 1.37×10^{-2}	4.5 - 6.5	Low	0.5 - 1.0

Source: Soil Survey: Camp Lejeune, North Carolina, U. S. Department of Agriculture - Soil Conservation Service, 1984.

- Notes:
- ML - Loam
 - SM - Loamy Fine Sand
 - SP - Fine Sand
 - - Not Estimated
 - SC - Fine Sandy Loam

TABLE 2-2

SUMMARY OF GROUNDWATER AND SURFACE WATER ELEVATIONS
 SITE 43
 REMEDIAL INVESTIGATION CTO-0303
 MCAS NEW RIVER, NORTH CAROLINA

Well No.	Casing Elevation	Static Water Levels (TOC)			Groundwater Elevations		
		3/25/95	4/23/95	5/1/95	03/25/95	04/23/95	05/01/95
43-GW01	8.26	4.16	6.74	6.92	4.10	1.52	1.34
43-GW01DW	7.43	4.21	5.16	5.36	3.22	2.27	2.07
43-GW02	8.03	5.19	7.23	7.60	2.84	0.80	0.46
43-GW03	6.58	4.28	5.83	6.12	2.30	0.75	0.46
43-GW04	9.03	4.46	5.90	6.18	4.57	3.13	2.85
43-GW04DW	7.84	4.07	5.07	5.28	3.77	2.77	2.56
43-PZ01	7.47	NA	NA	6.00	NA	NA	1.47
43-SG01	3.94	NA	Dry	Dry	NA	NA	NA
43-SG02	3.15	NA	0.94	1.02	NA	0.75	0.83
43-SG03	3.19	NA	0.86	0.98	NA	0.71	0.83

Notes:

TOC = Top of Casing
 NA = Data not available

TABLE 2-3

HYDRAULIC PROPERTIES SUMMARY
 SITE 43
 REMEDIAL INVESTIGATION CTO - 0303
 MCAS NEW RIVER, NORTH CAROLINA

Well ID	Conductivity		Transmissivity		Conductivity		Transmissivity		General Soil Description
	Rising Head (ft/day)	Falling Head (ft/day)	Rising Head (ft ² /day)	Falling Head (ft ² /day)	Rising Head (cm/sec)	Falling Head (cm/sec)	Rising Head (cm ² /sec)	Falling Head (cm ² /sec)	
43-GW01	1.0	--	35.0	--	3.53e-04	--	0.4	--	F/C sand, little silt
43-GW02	1.3	--	45.5	--	4.59e-04	--	0.5	--	M sand
43-GW04	9.9	--	346.5	--	3.49e-03	--	3.7	--	F sand, trace silt w/ fine to med sand layer
MAXIMUM	9.9	--	346.5	--	3.49e-03	--	3.7	--	
MINIMUM	1	--	35	--	3.53e-04	--	0.4	--	
AVERAGE	4.1	--	142.3	--	1.44e-03	--	1.5	--	
43-GW01DW	59.3	28.3	11,860	5,660	2.09e-02	9.99e-03	127.6	60.9	F/M sand, some shell frag, little silt
43-GW04DW	8.8	14.9	1,760	2,980	3.11e-03	5.26e-03	18.9	32.1	F/M sand, some shell frag, some silt
AVERAGE	34.1	21.6	6,810	4,320	1.20e-02	7.62e-03	73.3	46.5	

Notes:

- "--" Falling head slug test not performed as well level was within screened interval.
- Transmissivity calculation assumed 35 ft thickness for surficial aquifer
- Transmissivity calculation assumed 200 ft thickness for the Castle Hayne aquifer.

TABLE 2-4

**SUMMARY OF POTABLE WATER SUPPLY WELLS
WITHIN A ONE-MILE RADIUS OF SITE 43
REMEDIAL INVESTIGATION CTO-0303
MCAS NEW RIVER, NORTH CAROLINA**

Supply Well Number	Well Depth (ft)	Screened Interval (ft)	Well Dia. (in)	Approx. Dist. and Dir.	Status of Well	Al (µg/L)	Cu (µg/L)	Fe (µg/L)	Pb (µg/L)	Mn (µg/L)	Zn (µg/L)	Chloride (µg/L)	Fluoride (µg/L)	Nitrate/Nitrite (µg/L)	Sulfate (µg/L)	TDS
TC-1251	240	120-140	NA	4,300ft/SE	On	260 (5)	ND	490 (4)	ND	120 (4)	ND	170,000	500	30	6,000	660,000 (4)
MCAS-106	NA (2)	NA	NA	4,000ft/SSW	Off	NA	NA	NA	NA	NA	NA	NA	NA	NA	NA	NA
MCAS-203	173	NA	NA	4,000ft/SSW	On	360 (5)	ND	470 (4)	ND	ND	ND	180,000	1,400	ND	22,000	760,000 (4)
MCAS-131	200	NA	NA	5,000ft/SSW	On	ND	60	540 (4)	7	50	20	110,000	400	50	28,000	550,000 (4)

Notes:

The analytical data presented in this table represent detected analytes.

(1) Status not available

(2) Not available

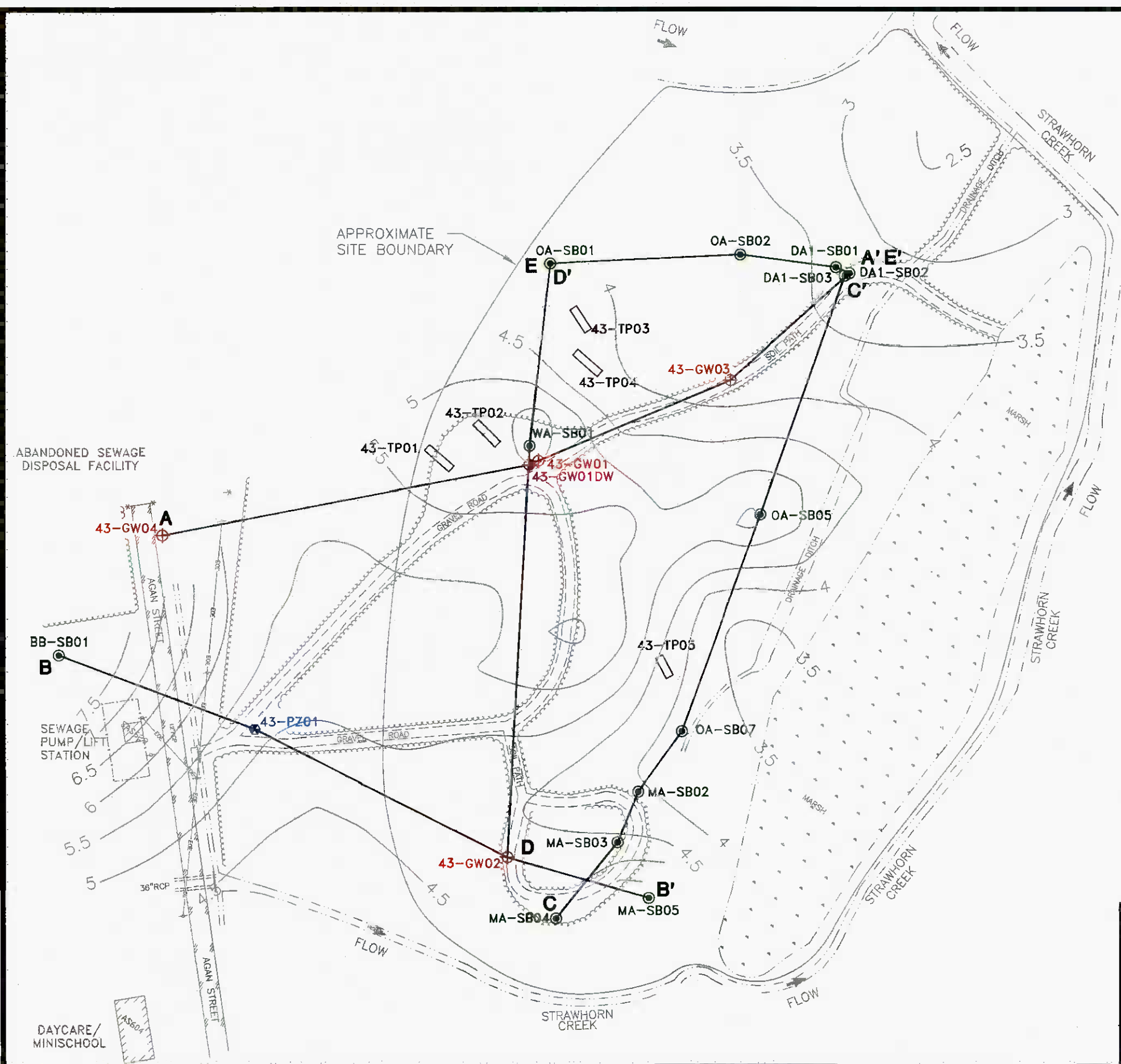
(3) Not detected

(4) Above USEPA & NC SMCL/Standard (Fe=300 µg/L, Mn=50 µg/L, TDS=500,000 µg/L)

(5) Above USEPA SMCL (Al=200 µg/L)

See Figure 2-6 for well locations.

SECTION 2.0 FIGURES



LEGEND

- 43-GW01 SHALLOW MONITORING WELL
- 43-GW01DW DEEP MONITORING WELL
- 43-PZ01 PIEZOMETER
- OA-SB01 SOIL BORING LOCATION
- 43-TP01 TEST PIT LOCATION
- A-A' CROSS SECTION TRAVERSE
- FLOW DIRECTION OF SURFACE WATER FLOW
- MARSH
- EOE OVERHEAD ELECTRIC LINE & UTILITY POLE
- FENCE
- ASPHALT ROAD
- GRAVEL ROAD OR SOIL PATH
- EDGE OF CREEK, DRAINAGE DITCH OR MARSH
- TREE LINE
- STRUCTURE

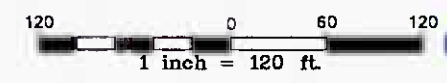
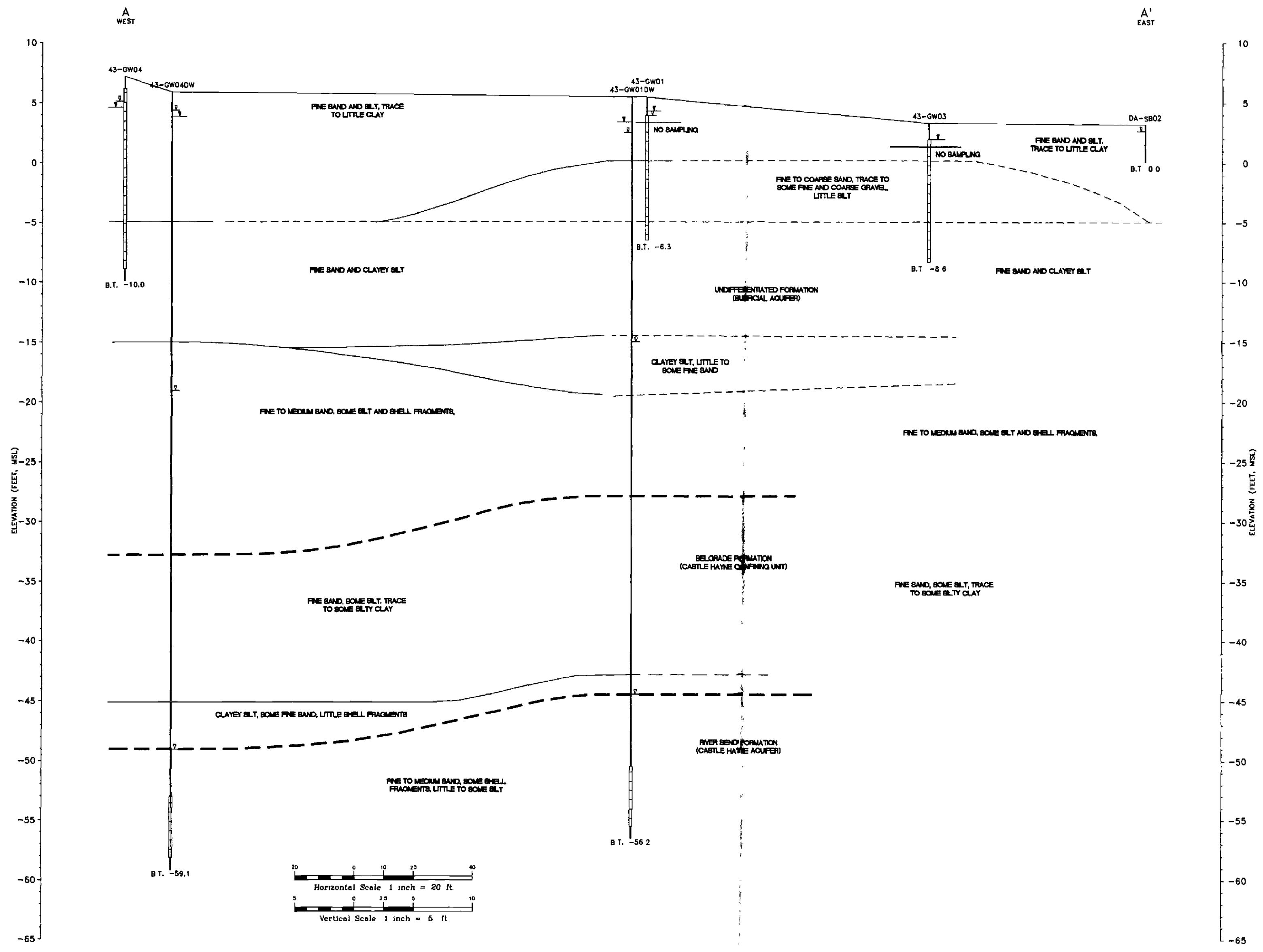


FIGURE 2-1
CROSS SECTION LOCATION AND APPROXIMATE
SURFACE ELEVATION CONTOUR MAP
SITE 43, AGAN STREET DUMP
REMEDIAL INVESTIGATION, CTO-0303
MARINE CORPS AIR STATION, NEW RIVER
NORTH CAROLINA

017134024

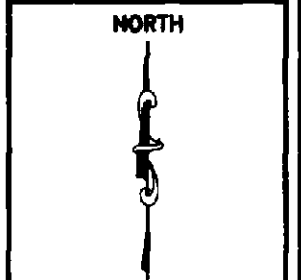


LEGEND
 - Groundwater Elevation (5/6/95)
 - Groundwater Encountered During Drilling
 B.T. -10.0 Boring Terminated, Elevation MSL
 - Well Screen Interval
 - Estimated
 - Projected
 - Formation Contact

NOTE
 - THE SOIL BORING INFORMATION IS CONSIDERED TO BE REPRESENTATIVE OF SUBSURFACE CONDITIONS AT THE RESPECTIVE BORING LOCATIONS. SUBSURFACE CONDITIONS INTERPOLATED BETWEEN BORINGS ARE ESTIMATED BASED ON ACCEPTED SOIL ENGINEERING PRINCIPLES AND GEOLOGIC JUDGMENT.

REVISIONS

DRAWN	WAC
REVIEWED	MKD
S.O.#	62470-303-0000-05200
CADD#	303009RI



REMEDIAL INVESTIGATION, CTO-0303
 MARINE CORPS AIR STATION, NEW RIVER
 NORTH CAROLINA

BAKER ENVIRONMENTAL, Inc.
 Coraopolis, Pennsylvania

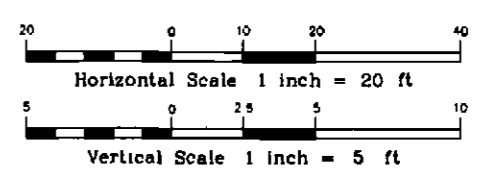
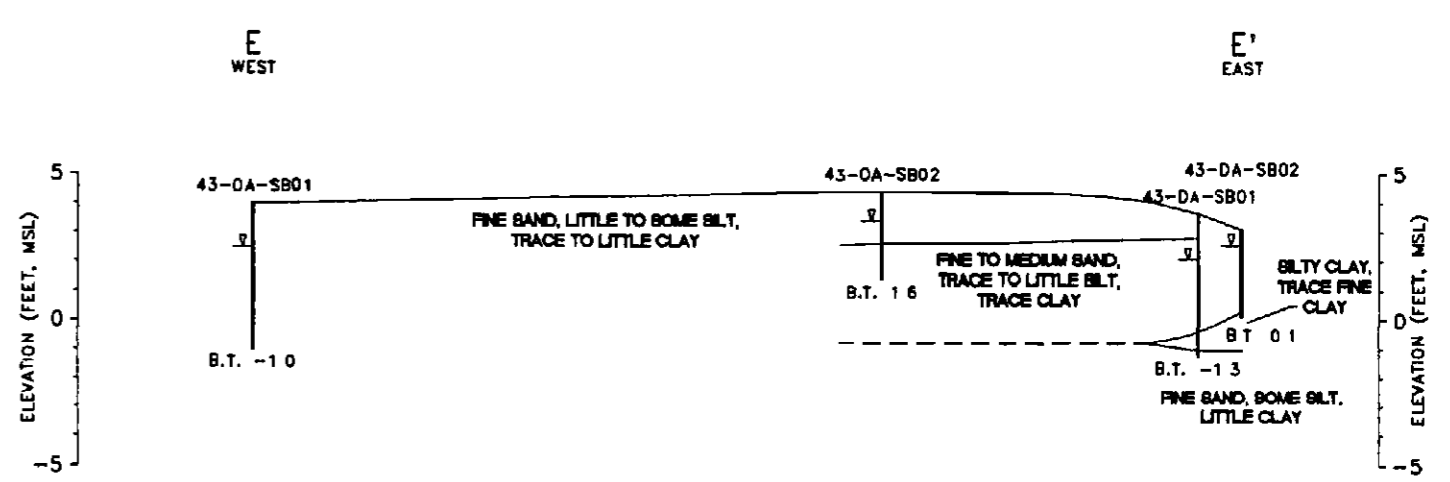
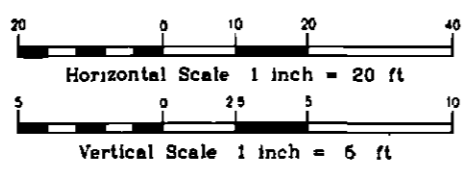
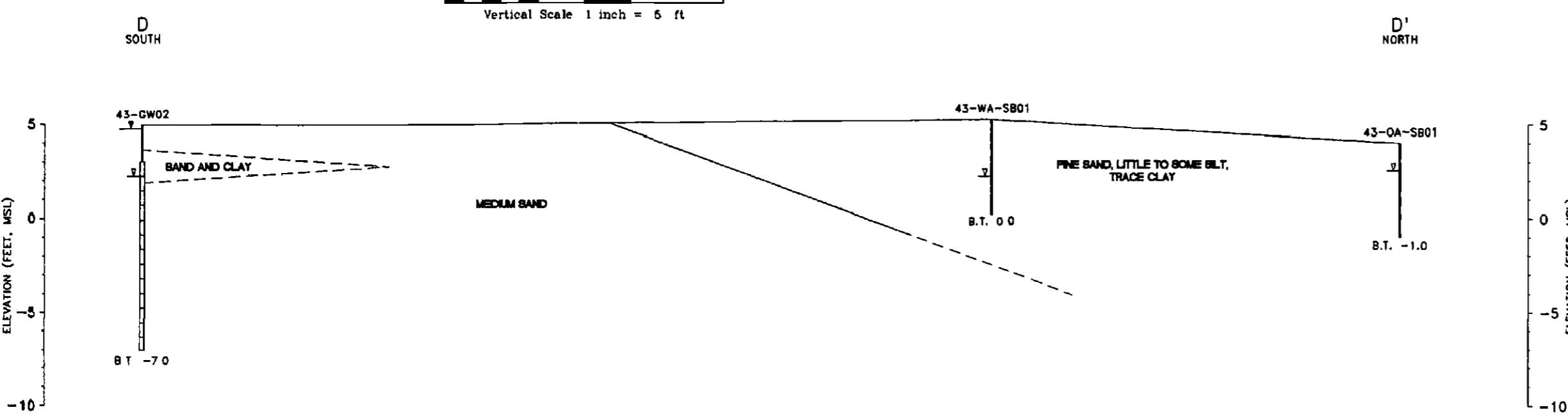
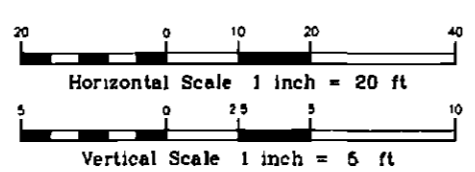
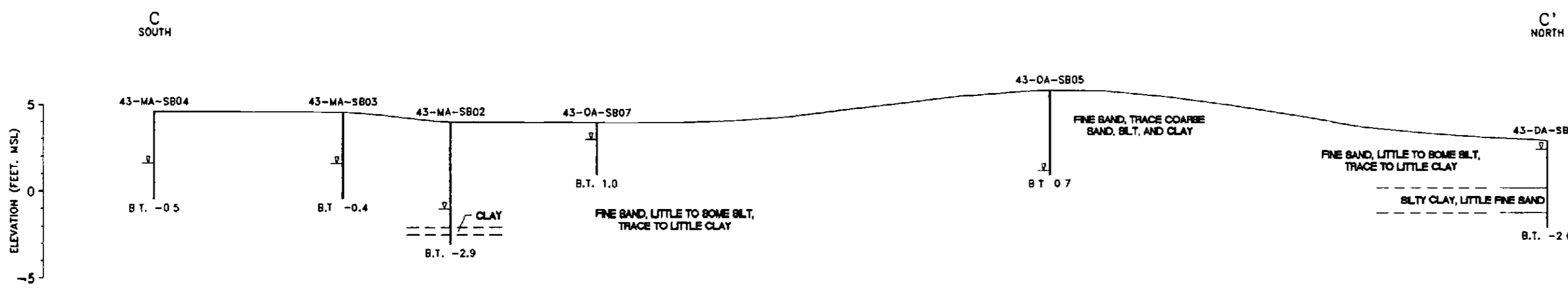
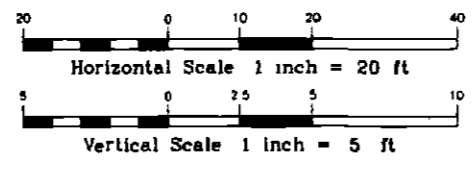
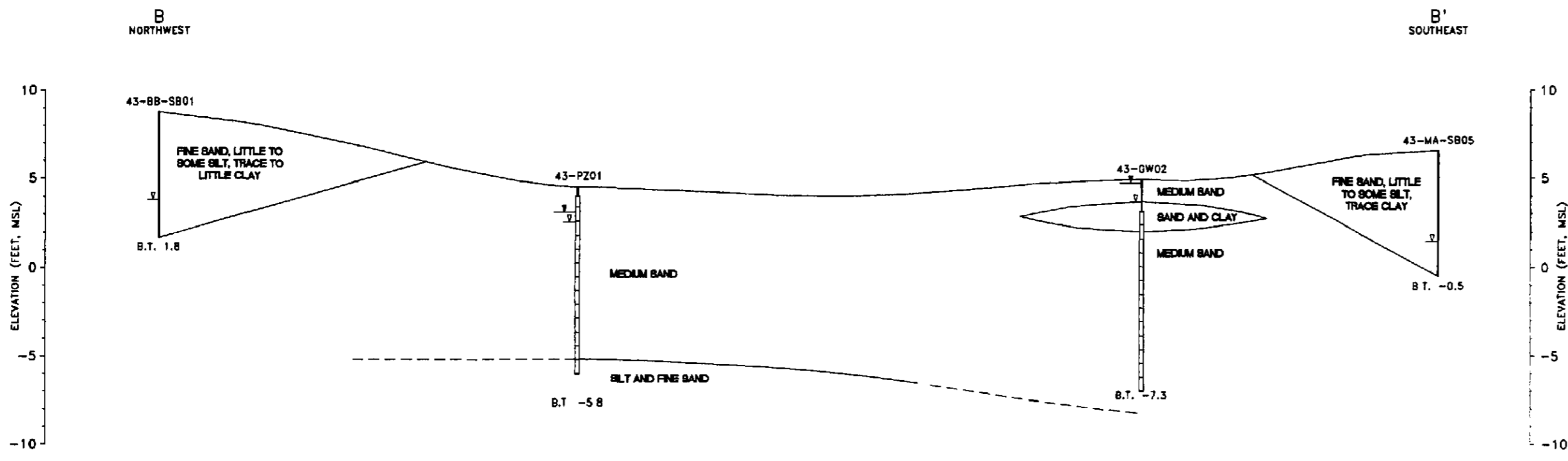


FIGURE No.
 2-2

SCALE AS SHOWN

DATE JANUARY 1996

017134B3X

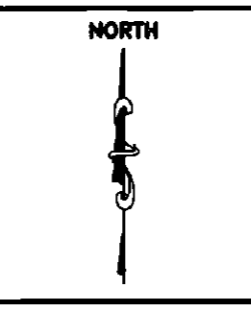


LEGEND
 - GROUNDWATER ELEVATION (5/9/95)
 - GROUNDWATER ENCOUNTERED DURING DRILLING BORING TERMINATED, ELEVATION MSL
 - B.T. 0" WELL SCREEN INTERVAL
 - ESTIMATED
 - PROJECTED

NOTE:
 -THE SOIL BORING INFORMATION IS CONSIDERED TO BE REPRESENTATIVE OF SUBSURFACE CONDITIONS AT THE RESPECTIVE BORING LOCATIONS. SUBSURFACE CONDITIONS INTERPOLATED BETWEEN BORINGS ARE ESTIMATED BASED ON ACCEPTED SOIL ENGINEERING PRINCIPLES AND GEOLOGIC JUDGEMENT.

REVISIONS	

DRAWN	WAC
REVIEWED	MKD
S.O.#	62470-303-0000-05200
CADD#	30301DRI



REMEDIAL INVESTIGATION, CTO-0303
 MARINE CORPS AIR STATION, NEW RIVER
 NORTH CAROLINA

BAKER ENVIRONMENTAL, Inc.
 Coraopolis, Pennsylvania



GEOLOGIC CROSS SECTIONS B-B',
 C-C', D-D' & E-E'
 SITE 43, AGAN STREET DUMP

SCALE AS SHOWN DATE JANUARY 1996

FIGURE No.
 2-2
 (cont'd.)

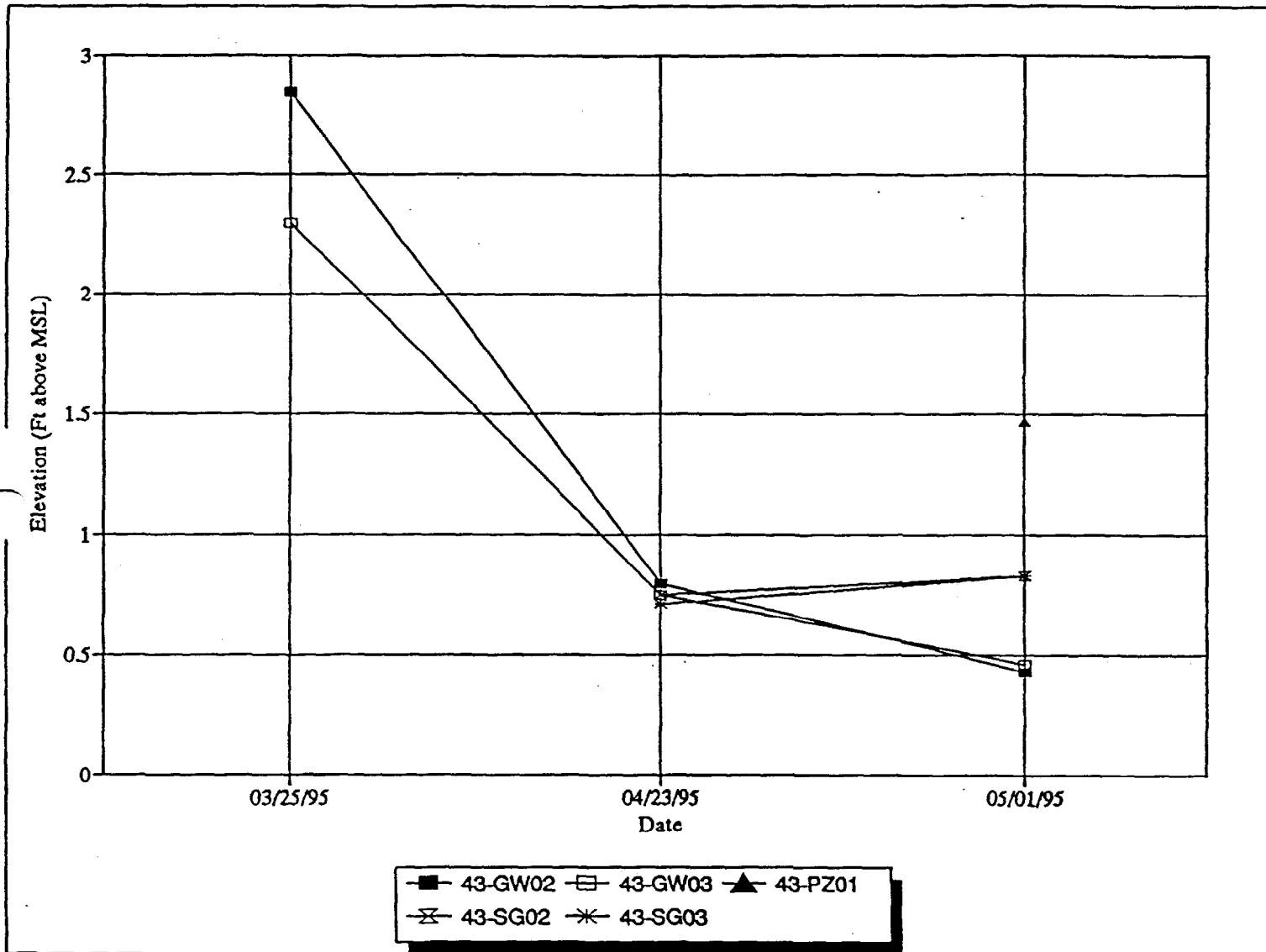


FIGURE 2-3A
 GROUNDWATER ELEVATION TRENDS
 AT SITE 43
 REMEDIAL INVESTIGATION CTO-0303
 MCAS NEW RIVER, NORTH CAROLINA

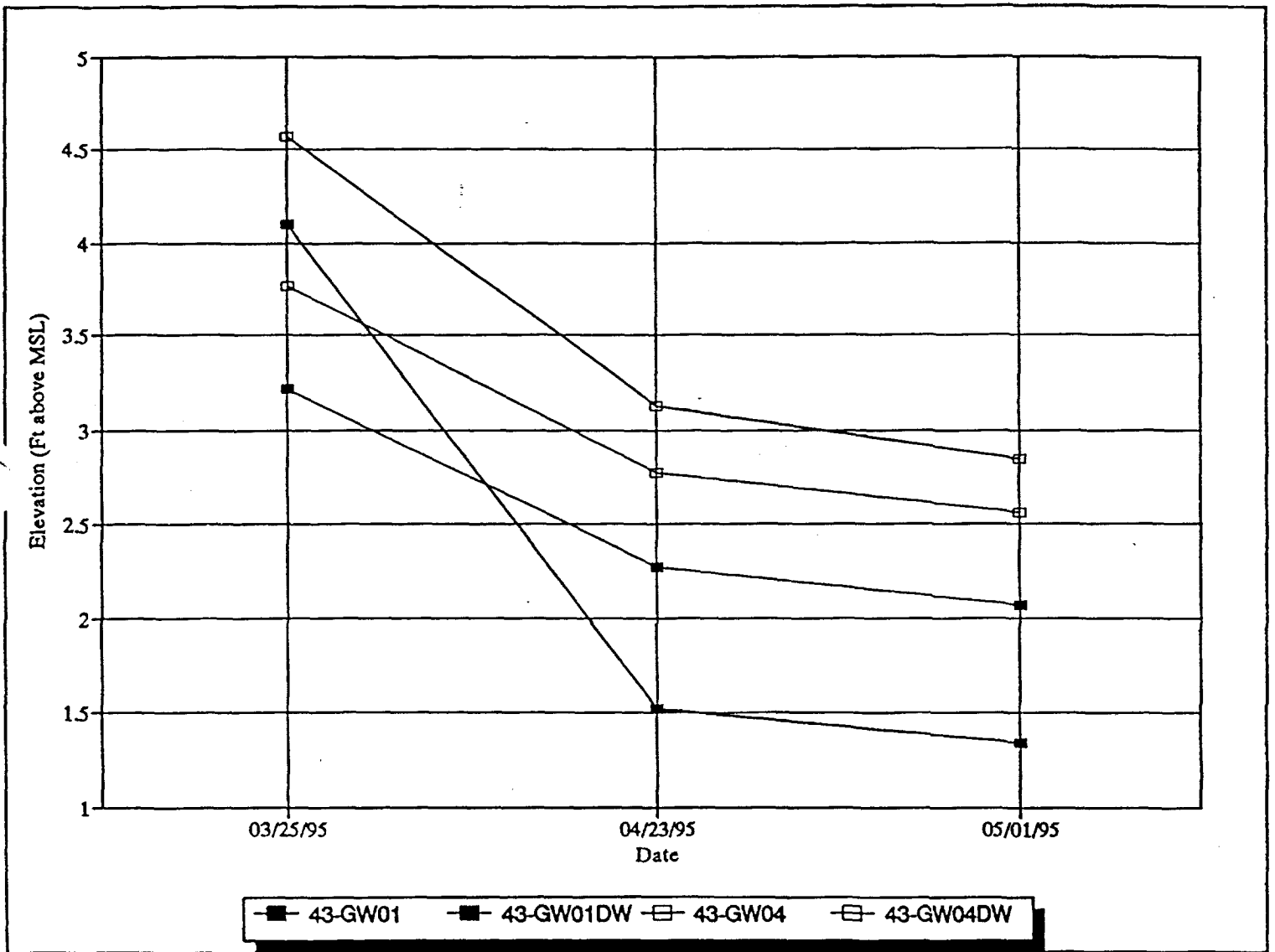


FIGURE 2-3B
 GROUNDWATER ELEVATION TRENDS
 AT SITE 43
 REMEDIAL INVESTIGATION CTO-0303
 MCAS NEW RIVER, NORTH CAROLINA

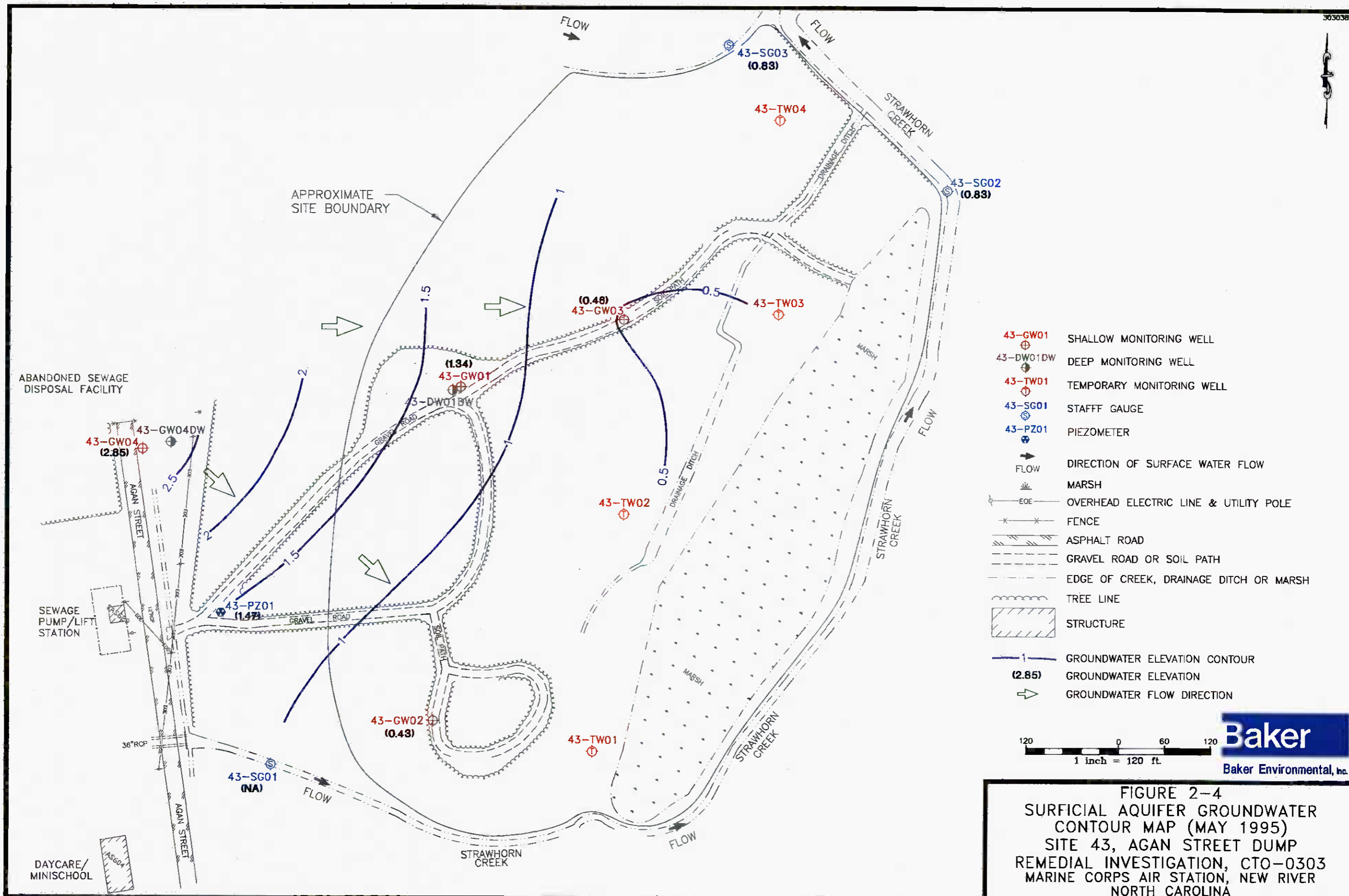
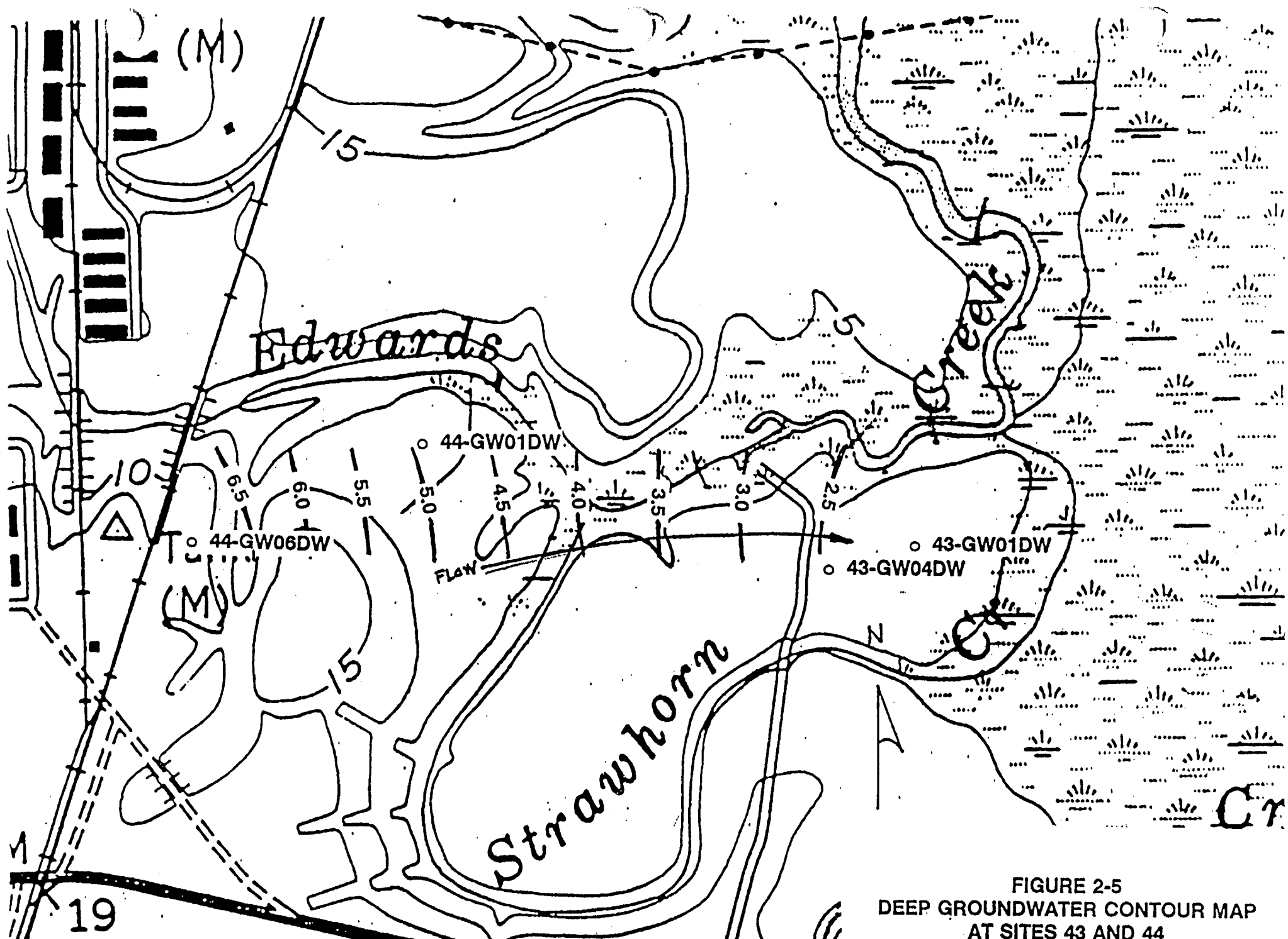


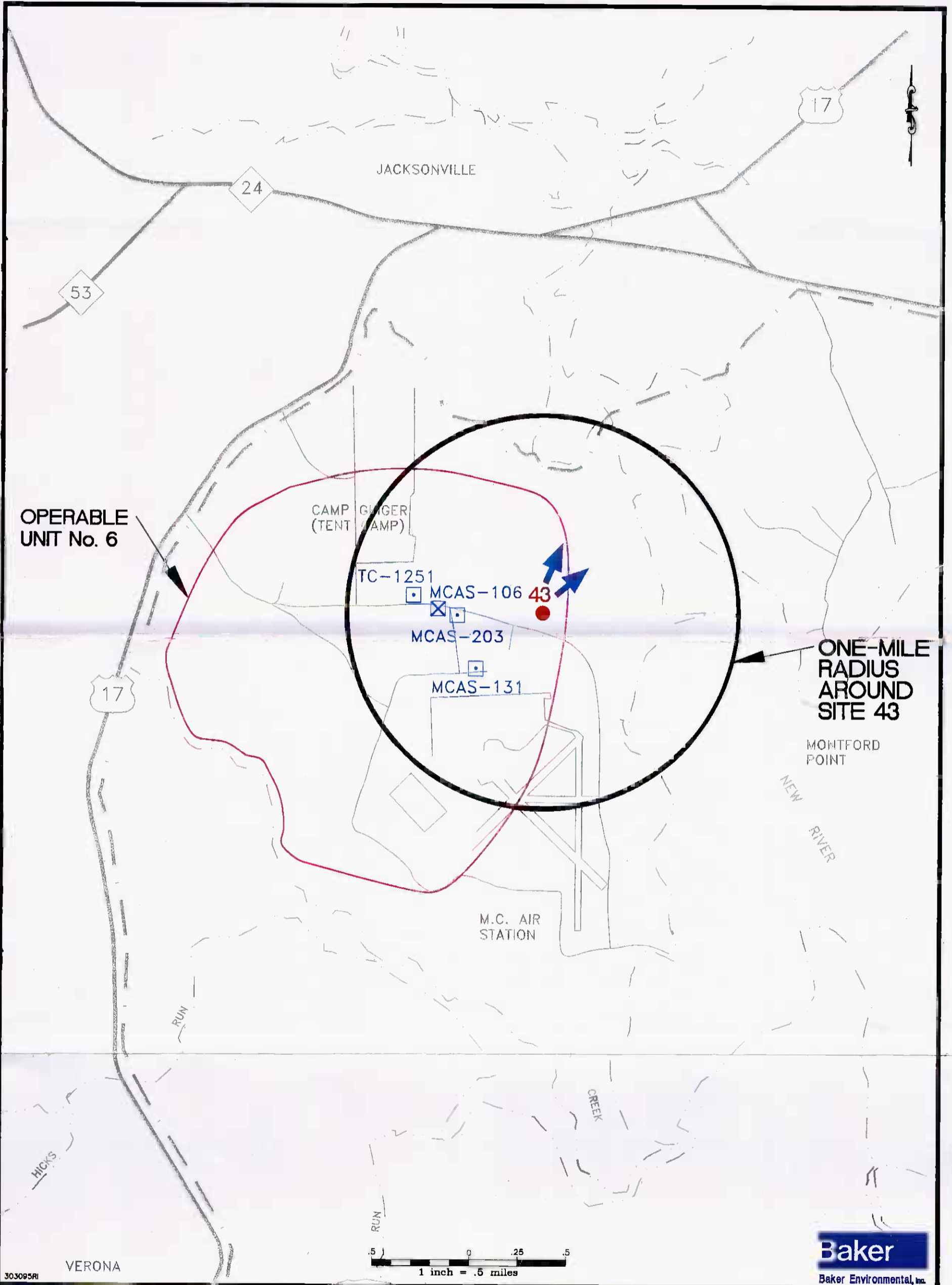
FIGURE 2-4
SURFICIAL AQUIFER GROUNDWATER
CONTOUR MAP (MAY 1995)
SITE 43, AGAN STREET DUMP
REMEDIAL INVESTIGATION, CTO-0303
MARINE CORPS AIR STATION, NEW RIVER
NORTH CAROLINA

01713Y03Y



Note: Monitoring well locations and contours are estimated and superimposed on a USGS quadrangle (Scale approx. 1-inch = 500-feet)

FIGURE 2-5
 DEEP GROUNDWATER CONTOUR MAP
 AT SITES 43 AND 44
 REMEDIAL INVESTIGATION CTO-0303
 MCAS NEW RIVER, NORTH CAROLINA



OPERABLE
UNIT No. 6

CAMP GINGER
(TENT CAMP)

TC-1251

MCAS-106 43

MCAS-203

MCAS-131

ONE-MILE
RADIUS
AROUND
SITE 43

MONTFORD
POINT

M.C. AIR
STATION

Baker

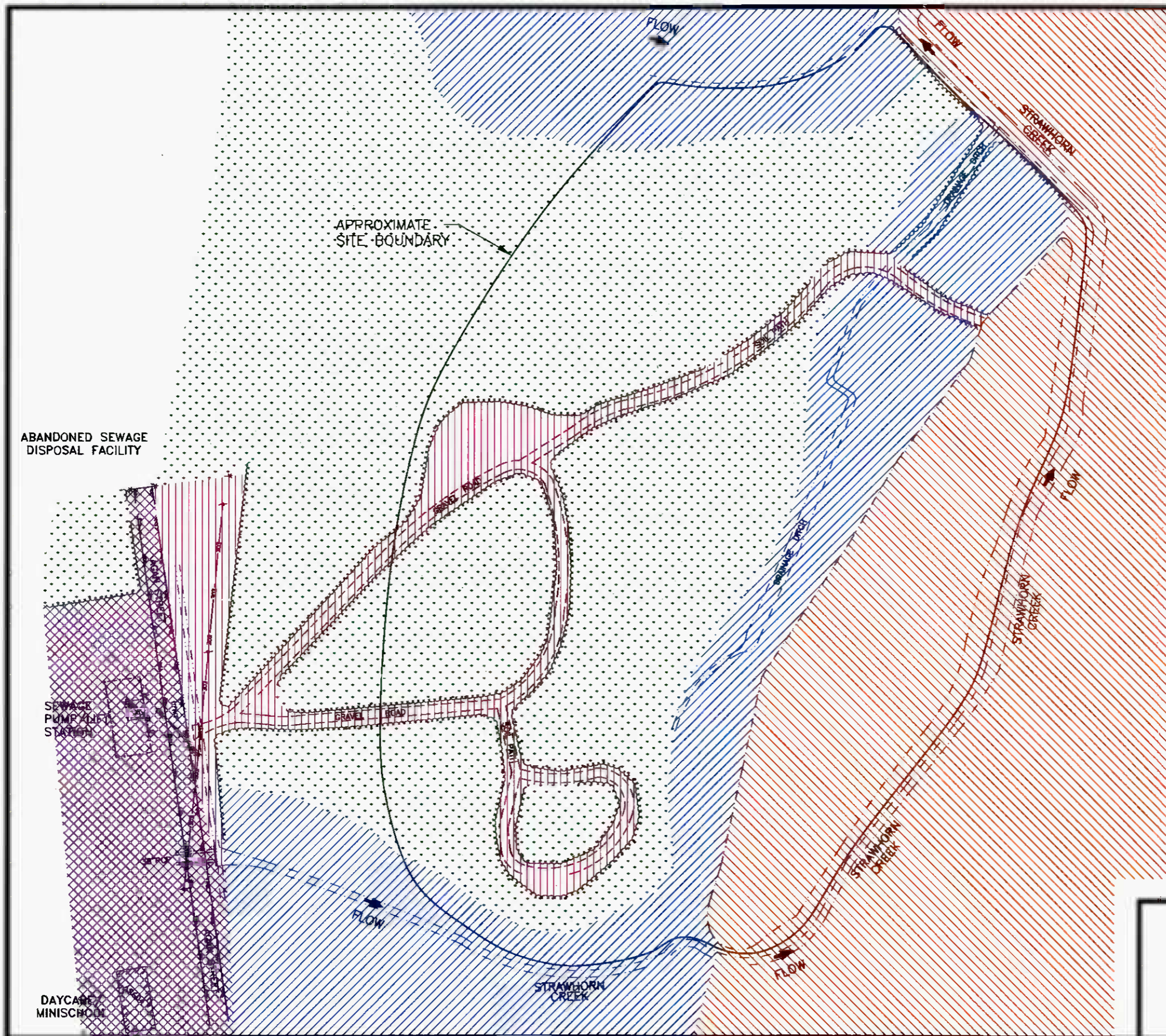
Baker Environmental, Inc.

LEGEND	
TC-1251	□ - WATER SUPPLY WELL IN SERVICE
MCAS-106	⊗ - WATER SUPPLY WELL OUT OF SERVICE
	➡ - APPROXIMATE DIRECTION OF GROUNDWATER FLOW FROM SITE

FIGURE 2-6
POTABLE WATER SUPPLY WELLS
WITHIN A ONE-MILE RADIUS
SITE 43, AGAN STREET DUMP
REMEDIAL INVESTIGATION, CTO-0303
MARINE CORPS BASE, CAMP LEJEUNE
NORTH CAROLINA

SOURCE: LANTDIV, OCT. 1991

01713V B4Y



ESTUARINE, INTERTIDAL, SCRUB SHRUB, BROAD-LEAVED DECIDUOUS, NEEDLE-LEAVED DECIDUOUS, IRREGULARLY-FLOODED WETLAND

PALUSTRINE, FORESTED, BROAD-LEAVED DECIDUOUS TEMPORARILY FLOODED, DITCHED WETLAND

OPEN AREA

MIXED FOREST

INDUSTRIAL AREA

FLOW DIRECTION OF SURFACE WATER FLOW

EOE OVERHEAD ELECTRIC LINE & UTILITY POLE

FENCE

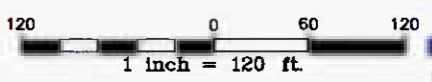
ASPHALT ROAD

GRAVEL ROAD OR SOIL PATH

EDGE OF CREEK, DRAINAGE DITCH OR MARSH

TREE LINE

STRUCTURE



Baker
Baker Environmental, Inc.

FIGURE 2-7
BIOHABITAT MAP
SITE 43, AGAN STREET DUMP
REMEDIAL INVESTIGATION, CTO-0303
MARINE CORPS AIR STATION, NEW RIVER
NORTH CAROLINA

3.0 STUDY AREA INVESTIGATIONS

The field investigation program at OU No. 6, Site 43, was initiated to detect and characterize potential impacts to human health and the environment resulting from past waste management activities. This section discusses the site-specific RI field investigation activities that were conducted to fulfill the objective. The RI field investigation of OU No. 6 commenced on February 20, 1995 and continued through May 10, 1995. The RI field program at Site 43 consisted of a site survey; a soil investigation, which included sampling and test pit excavations; a groundwater investigation, which included monitoring well installation, sampling, and aquifer testing; a surface water and sediment investigation; a habitat evaluation; and a bioassay study. The following sections detail the various investigation activities carried out during the RI.

3.1 Site Survey

The site survey task was performed in two phases: Phase I - Initial Survey of Site Features; and Phase II - Post Investigation Survey of Monitoring Wells and Sampling Locations. Phase I of the survey task was conducted at Site 43 during December of 1994. Based upon the Initial Site Assessment Study (WAR, 1983) and Site Inspection Report (Baker, 1994a), surface features within and surrounding the suspected disposal areas were surveyed. The proposed soil boring and monitoring well locations identified in the Final RI/FS Work Plan for OU No. 6 (Baker, 1994b), were subsequently located as part of the Phase I survey and marked with wooden stakes. Each sample location was assigned a unique identification number that corresponded to the site and media to be sampled.

Phase II of the site survey task was completed at Site 43 during the week of May 10, 1995. During Phase II, all existing and newly installed monitoring wells were surveyed. Supplemental or relocated soil borings and exploratory test pits completed during the investigation were also surveyed. A number of soil borings were relocated from the locations proposed in the project plans (i.e., moved more than ten feet from their proposed locations) due to the presence of either underground or overhead utilities. Soil test borings were also moved from their proposed locations based upon observed conditions and the presence of partially buried containers. Additionally, staff gauges installed in both Strawhorn and Edwards Creek were also surveyed during Phase II. Latitude, longitude, and elevation in feet above mean sea level (msl) were recorded for each surveyed point.

3.2 Soil Investigation

The soil investigation performed at Site 43 was intended to:

- Assess the nature and extent of contamination that may have resulted from previous disposal practices or site activities;
- Assess the human health, ecological, and environmental risks associated with exposure to surface and subsurface soils; and
- Characterize the geologic setting of the study area.

The subsections which follow describe soil sample collection procedures, soil boring locations, and the analytical program initiated during the soil investigation at Site 43.

3.2.1 Soil Sampling Procedures

Sampling activities at Site 43 commenced on February 28, 1995. Soil collection was performed using a direct-push (GeoProbe™) sampling system. Borings were advanced by either a truck-mounted rig or by a hand sampler unit. The direct-push sampling system employed a stainless steel cutting shoe and collection tube. A dedicated acetate liner, inserted into the stainless steel collection tube, was used to collect and then extrude soil samples for field and laboratory analyses. All soil sampling activities conducted at Site 43 were performed in Level D personnel protection. Soil cuttings obtained during the soil investigation were collected, handled, and stored according to the procedures outlined in Section 3.7.

Two types of borings were installed during the soil investigation: exploratory test borings (i.e., borings installed for sample collection and description of subsurface units) and borings advanced for the purpose of monitoring well installation. Selected soil samples from each of the two types of borings were submitted for laboratory analysis (see Section 3.2.4). Soils obtained from exploratory borings were collected from the surface (i.e., ground surface to a depth of twelve inches) and at continuous two-foot intervals starting at one foot below ground surface. Continuous sample collection proceeded until the boring was terminated at the approximate depth of the water table, which varied at Site 43 from 1 to 5 feet below ground surface. An additional soil sample was collected from below the water table to confirm groundwater depth and ensure that the true water table had been encountered (i.e., not a perched zone).

Samples were collected for soil description from the ground surface and at continuous two-foot intervals to the water table. Each soil was classified in the field by a geologist using the Unified Soil Classification System (USCS) in accordance with the visual-manual methods described by the American Society for Testing and Materials (ASTM, 1993a). Descriptions were recorded in a field logbook and later transposed onto boring log records. Soil classification included characterization of soil type, grain size, color, moisture content, relative density, plasticity, and other pertinent information such as indications of contamination. Descriptions of site soils are provided on Test Boring Records in Appendix A and on Test Boring and Well Construction Records in Appendix B.

Surface and selected subsurface (i.e., greater than one foot below ground surface) soil samples were retained for laboratory analysis from each of the soil borings. Both surface and subsurface samples were collected to evaluate the nature and extent of potentially impacted soils and to perform the human health risk assessment; however, only the surface soils were employed for the ecological risk assessment. A summary of test boring identification numbers, boring depths, sampling intervals, and laboratory analyses for Site 43 soil samples is provided in Tables 3-1 and 3-2.

Where conditions warranted (i.e., when groundwater was encountered at depths greater than four feet bgs) a minimum of two samples were retained for laboratory analyses from each of the soil boring locations. In addition, a number of surface soil samples were retained from a potentially impacted area identified during the initial phase of the investigation. Each soil sample was prepared and handled according to USEPA Region IV Standard Operating Procedures (SOPs). Samples collected for volatile organic analysis were extracted with a stainless-steel spoon from different sections of the extruded soil core so that the resulting composite was representative of the entire sampling interval. Precautions were taken not to aerate the sample, thus minimizing volatilization. Samples retained for other analytical parameters (e.g., semivolatiles, pesticides, PCBs, and metals) were thoroughly homogenized prior to being placed in the appropriate laboratory containers.

Following sample collection, each sample retained for laboratory analysis was stored on ice in a cooler. Sample preparation also included documentation of sample number, depth, location, date, time, and analytical parameters in a field logbook. Chain-of-Custody documentation, copies of which are provided in Appendix D, included information such as sample number, date, time of sampling, and sampling personnel, accompanied the samples to the laboratory. Samples were shipped by overnight courier to the laboratory.

3.2.2 Sampling Locations

Representative samples from the study area were collected and submitted for laboratory analysis of target compound list (TCL) organics (i.e., volatiles, semivolatiles, pesticides, and PCBs) and target analyte list (TAL) metals. A total of 20 test borings were sampled during the soil investigation at Site 43. An additional seven surface soil samples were later added to the investigation beyond the initial work scope. A potentially impacted area adjacent to monitoring well 43-GW01 was preliminarily identified in the SI Report for Site 43 (Baker, 1994a) and confirmed through seven-day soil sample analysis performed while investigation activities continued elsewhere. Three additional borings, to the west of the study area, were advanced to assess background contaminant concentrations (43-BB-SB01, 43-BB-SB02, and 43-BB-SB03).

Soil samples were collected throughout Site 43 as shown on Figure 3-1. The sampling distribution employed was intended to identify if contamination was present and, if so, to evaluate the vertical and horizontal extent within the study area. The soil sampling program at Site 43 focused on known or suspected disposal areas. Previous investigatory data and background reports were used to locate potential sampling locations. In addition, evidence of soil disturbance, stressed vegetative cover, and historic aerial photographs were also employed to locate potential soil and exploratory test pit locations.

A total of 20 borings were advanced to assess suspected waste disposal at Site 43; only one of those borings were utilized for the installation of a monitoring well (refer to Figure 3-1). Five of the 18 boring locations were advanced within the Mounded Area, identified in the Final RI/FS Work Plan for OU No. 6 (Baker, 1994b). A total of five soil test borings were completed at two separate locations identified as having partially buried containers. The remaining eight soil borings were completed at the various locations throughout the site shown on Figure 3-1.

A total of seven surface soil samples were also collected from an area immediately adjacent to monitoring well 43-GW01 (refer to Figure 3-1). During the 1991 site inspection, the pilot test boring for 43-GW01 was identified as having elevated concentrations of PAHs. The somewhat focused sampling activity surrounding well 43-GW01 was performed in an effort to further evaluate the extent of surface soil contamination. Three surface soil samples (43-WA-SB01A, 43-WA-SB01B, AND 43-WA-SB01C) were collected in a semicircular pattern extending 15 feet to the north and east of soil boring 43-WA-SB01. An additional four surface soil samples (43-WA-SB01A1, 43-WA-SB01A2, 43-WA-SB01A3, and 43-WA-SB01A4) were later collected to more adequately assess the horizontal extent of contamination in the same area, based on the results of the initial seven.

3.2.3 Exploratory Test Pits

A total of five exploratory test pits were completed in conjunction with the soil investigation at Site 43 (refer to Figure 3-1). The exploratory test pit investigation was conducted to assess the nature

of any buried material within suspected disposal areas. Excavation logs, provided in Appendix C, describing the contents of each test pit were maintained during field operations. Soil samples from selected exploratory test pits were submitted for laboratory analysis of compounds associated with toxicity characteristic leaching procedure (TCLP) and Resource Conservation and Recovery Act (RCRA) characteristics. Laboratory confirmation analysis of excavated soil was necessary when staining was evident or when organic contamination was indicated through field screening.

Potential test pit locations were identified through visual site inspection and use of a hand-held magnetometer. The visual site inspection sought to identify signs of contamination or waste disposal activity such as soil staining, debris, fill areas, or depressions. In conjunction with the visual site inspection, a magnetometer was employed during the test pit investigation to identify buried metallic objects. Because of the presence and wide distribution of metallic debris throughout the study area, only locations with magnetic detections indicating metallic objects greater than three feet in length were selected for excavation activities.

During the excavation of exploratory test pits by backhoe, Level B personal protective equipment (e.g., supplied air) was employed. In general, test pit dimensions measured 10 to 15 feet in length and 2 to 3 feet in width. The depth of each test pit varied according to the depth of the encountered water table and the total depth of fill material.

3.2.4 Analytical Program

The analytical program initiated during the soil investigation at Site 43 focused on suspected contaminants of concern, as indicated by information regarding previous disposal practices and investigation results. Samples from each of the 20 test borings were analyzed for TAL inorganics and either TCL semivolatiles only or full TCL organics (refer to Tables 3-1 and 3-2). In addition to the samples collected from soil test borings, seven surface soil samples were analyzed for TCL semivolatiles only. One composite soil sample was also collected for analysis of engineering parameters (i.e., particle size, and Atterberg limits). The engineering sample was comprised of individual grab samples collected from the ground surface to the water table. Samples were prepared and handled as described in the previous section. Tables 3-1 and 3-2 present a summary of requested soil analyses.

One soil sample was also collected for analysis of permeability, grain size, and soil type. A thin-walled tube (i.e., shelly tube) was employed to collect, according to ASTM D-1587 (ASTM, 1994), an undisturbed sample of the semi-confining layer that separates the surficial and Castle Hayne aquifers. The sample was tested in accordance with the following procedures:

- ASTM D-422 - Particle Size Analysis of Soils (ASTM, 1990a)
- ASTM D-4318 - Liquid Limit, Plastic Limit, and Plasticity Index of Soils, (ASTM, 1993b)
- ASTM D-5084 - Hydraulic Conductivity of Saturated Porous Materials, (ASTM, 1990b)

Findings from these and USCS soil classification analyses are presented in Appendix L.

3.2.5 Quality Assurance and Quality Control

Field QA/QC samples were collected during the soil investigation. These samples were obtained to: (1) monitor that decontamination procedures were properly implemented (equipment rinse)

samples); (2) evaluate field methodologies (duplicate samples); (3) establish field background conditions (field blanks); and (4) evaluate whether cross-contamination occurred during sampling and shipping (trip blanks). Data Quality Objectives (DQOs) for the QA/QC samples were implemented in accordance with DQO Level IV as defined in the Environmental Compliance Branch SOPs and Quality Assurance Manual, USEPA Region IV (USEPA, 1991). This DQO level is equivalent to the Naval Facilities Engineering Service Center (NFESC) DQO Level D, as specified in the "Sampling and Chemical Analysis Quality Assurance Requirements for the Navy Installation Restoration Programs" document (NEESA, 1988).

Four types of field QA/QC samples were collected and analyzed including: duplicate samples; equipment rinsates samples; field blanks; and trip blanks. The definition of each is listed below (USEPA, 1991):

- **Duplicate Sample:** Two or more samples collected simultaneously into separate containers from the same source under identical conditions.
- **Equipment Blanks:** Equipment field blanks (or rinsate blanks) are defined as samples which are obtained by running organic free water over/through sample collection equipment after it has been cleaned. These samples are used to determine if decontamination procedures were adequate. A minimum of one equipment blank per sample media was collected daily, however, only every other blank was analyzed.
- **Field Blanks:** Organic-free water is taken to the field in sealed containers and poured into the appropriate sample containers at designated locations. This is done to determine if contaminants present in the area may have an affect on the sample integrity.
- **Trip Blanks:** Trip blanks are prepared prior to the sampling event, placed in the actual sample container, and kept with the investigative samples throughout the sampling event. They are then packaged for shipment with the other samples and sent for analysis. At no time after their preparation are the sample containers to be opened before they return to the laboratory. Field sampling teams utilize volatile organic trip blanks to determine if samples were contaminated during storage and transportation back to the laboratory. If samples are to be shipped, trip blanks are to be provided for each shipment but not necessarily for each cooler (i.e., trip blanks in coolers with samples for VOC analyses only).

Table 3-3 summarizes field QA/QC sample types, sample frequencies, the number of QA/QC samples, and parameters analyzed. Field QA/QC samples were collected at Site 43 according to the procedures outlined in the USEPA Region IV SOPs.

3.2.6 Air Monitoring and Field Screening

Several air monitoring and field screening procedures were implemented during soil investigation activities at Site 43. Ambient air monitoring for volatile contaminants was performed at each open borehole using a photoionization detector (PID). During exploratory test pit operations, the ambient air was monitored for volatile organics with both a PID and a flame ionization detector (FID).

Soil samples were field screened for volatile organic contaminants with a PID. Excavated soil from exploratory test pits was screened with both PID and FID. Measurements obtained in the field were recorded in a logbook and later transposed onto the Test Boring Records and the Well Construction Records (provided in Appendices A and B). Prior to daily monitoring, the field instruments were calibrated and documentation was recorded in a field logbook and on appropriate calibration forms.

3.3 Groundwater Investigation

The groundwater investigation performed at Site 43 was intended to:

- Assess the nature and extent of contamination that may have resulted from previous disposal practices or site activities;
- Assess human health and environmental risks associated with exposure to groundwater; and
- Characterize the hydrogeologic setting of the study area.

The subsections which follow describe well installation procedures, sample collection procedures, the analytical program, and hydraulic conductivity test procedures employed during the groundwater investigation at Site 43.

3.3.1 Monitoring Well Installation

One shallow Type II monitoring well (i.e., a well installed without casing to seal off a semi-confining or confining layer) was installed at Site 43 on March 23, 1995. The location of monitoring well 43-GW04 is depicted on Figure 3-2. The newly installed shallow monitoring well was situated spatially to intercept potentially impacted groundwater from the suspected disposal area, and to characterize the nature and horizontal extent of possible contamination. In conjunction with newly-installed and existing monitoring wells, a newly-installed piezometer was used to evaluate groundwater flow patterns within the upper portion of the surficial aquifer. Two deep Type III monitoring wells (i.e., wells installed with casing to seal off a confining or semi-confining layer) were also installed during March of 1995 at Site 43 (refer to Figure 3-2). The two deep wells were installed to assess the nature and vertical extent of contamination and to evaluate the flow pattern of the deeper aquifer (i.e., the Castle Hayne aquifer). Placement of the newly installed monitoring wells was based on review of previous investigations, and analytical data generated during the SI.

Shallow monitoring well 43-GW04 was installed after the borehole had been advanced to the desired depth. The borehole was then reamed with 6-1/4-inch internal diameter (ID) hollow stem augers prior to installation. Monitoring well 43-GW04 was installed at 17 feet below ground surface, and deep wells 43-GW01DW and 43-GW04DW were installed at 61 and 64 feet below ground surface. The shallow monitoring well was installed at approximately 10 feet below the water table encountered during the pilot hole test boring. The screened interval of the shallow monitoring well bi-sects the water table sufficiently to compensate for seasonal variations in the water table which is known to fluctuate from two to four feet. Well construction details are summarized in Table 3-4, and well construction diagrams are shown on the Test Boring and Well Construction Records provided in Appendix B.

The two deep monitoring wells were installed upon completion of pilot hole test borings, advanced using the wash rotary drilling method. Each borehole was drilled with a 6-inch wing bit prior to well installation. Steel casing was installed in semi-confining, less permeable, geologic material (i.e., a combination of sand, silt, and clay) at the bottom of the surficial aquifer. The two deep monitoring wells were screened at intervals just below the semi-confining unit in the upper portion of the Castle Hayne aquifer. Screened intervals for the two deep wells ranged from approximately 56 to 64 feet below ground surface (refer to Table 3-4 and Appendix B for well construction details).

Each of the permanent monitoring wells were constructed of two-inch nominal diameter, Schedule 40, flush-joint and threaded, polyvinyl chloride (PVC) casing. Justification for the use of PVC casing is provided in Appendix B of the Field Sampling and Analysis Plan for Operable Unit No. 6 (Baker, 1994b). The shallow well utilized a 15-foot screen comprised of a 10- and 5-foot long No. 10 (i.e., 0.01 inch) slotted screen sections. The two deep monitoring wells were constructed with a five-foot No. 10 slotted screen section. A fine-grained sand pack (i.e., No. 1 silica sand), extending approximately 2 feet above the top of the screen, was placed in the annulus between the screen and the borehole wall from inside the augers during shallow well installation. The sand pack was poured manually down the borehole during deep well installation and checked continuously with a weighted tape measure to determine sand pack depth. A two- to three-foot sodium bentonite pellet seal was placed above the sand pack by dropping pellets down the borehole. The bentonite pellets were hydrated with potable water after placement. A sodium bentonite slurry was used to backfill the annular space from above the bentonite pellet seal to the bottom of the steel casing (i.e., above the semi-confining unit). The remaining annular space was backfilled with a mixture of portland cement and five percent powdered bentonite. During construction of the Type III deep wells, portland cement was used to secure six-inch steel casing to the uppermost portion of the semi-confining layer. A five-foot by five-foot concrete pad was placed around the protective well casing and four protective bollard posts were installed around the corners of the concrete pad. A four-inch protective well casing with locking cover was placed over the well and set into the cement pad. Well tags, which provide construction information, were installed at the top of each well. Typical shallow Type II and deep Type III well construction details are shown on Figures 3-3 and 3-4.

In addition to the permanent wells installed at Site 43, four temporary wells were employed to assess groundwater conditions in areas along the northern and eastern perimeter of the study area which is not suited for permanent well construction. The temporary wells were constructed of one-inch nominal diameter, Schedule 40, flush-joint and threaded PVC casing placed in an open borehole. A filter sock was used to filter fine materials from the surrounding formation. Immediately following sample acquisition the temporary wells were removed.

3.3.2 Monitoring Well Development

Following well construction and curing of the bentonite seal and cement grout, each newly installed monitoring well was developed to remove fine-grained sediment from the screen and sandpack and to establish interconnection between the well and the surrounding formation. The shallow wells were developed by a combination of surging and pumping. The intermediate and deep wells were developed using a forced air system, equipped with a filter, and "lifting" the water out of the well. Typically, 20 to 40 gallons of water were evacuated from the shallow wells, followed by 10 minutes of surging, then continued pumping. Three to five borehole volumes were evacuated from each deep well, approximately 100 to 250 gallons. Groundwater recovered during well development was temporarily stored in drums, then transferred into on-site storage tanks (refer to Section 3.8).

Pumping hoses, constructed of flexible PVC, were used once and discarded to minimize the potential for cross contamination.

Three to five borehole volumes were removed from each well, where conditions permitted, until the groundwater was essentially sediment-free. Measurements of pH, specific conductance, and temperature were recorded after each volume was removed to assist in assessing well stabilization. Additionally, periodic flow and volume measurements were also recorded during development to evaluate flow rates of the shallow water-bearing zone. Well Development Forms that summarize this information are provided in Appendix E.

3.3.3 Water Level Measurements

Static water level measurements were collected after all well development activities had been completed. Measurements were recorded from top-of-casing (TOC) reference points marked on the PVC casing at each existing and newly-installed well. Water level measurements were collected on March 23, April 10, May 9, and August 18, 1995. Groundwater measurements were recorded using an electric measuring tape which were recorded to the nearest 0.01 foot. Water level data from site monitoring wells and staff gauges were collected within a three-hour period. A summary of water level measurements is provided in Table 3-5.

3.3.4 Aquifer Testing

Well-head tests (i.e., slug tests) were performed on selected wells at Site 43 as part of the groundwater investigation. Aquifer testing results, provided in Appendix N. Both falling- and rising-head tests were performed to approximate individual well characteristics and to provide generalized information regarding aquifer parameters within the study area.

3.3.5 Sampling Locations

Groundwater samples were collected from three existing shallow wells (43-GW01, 43-GW02, and 43-GW03), the newly installed shallow well (43-GW04), four temporary wells (43-TW01 through 43-TW04), and the two newly installed deep wells (43-GW01DW and 43-GW04DW) at Site 43. The locations of the newly installed, temporary, and existing monitoring wells are shown on Figure 3-2. The groundwater sampling round was conducted at Site 43 in April of 1995.

3.3.6 Sampling Procedures

Groundwater samples were collected to assess whether contamination was present in the shallow and deep aquifers resulting from previous disposal practices at Site 43. Based upon previous investigative results and historical records, the contaminants of concern were volatiles, aromatic hydrocarbons (PAHs), and metals. Accordingly, the sampling program initiated at Site 43 focused on these contaminants.

Prior to groundwater purging, a water level measurement from each well was obtained according to procedures outlined in Section 3.3.3. The total well depth was also recorded from each well to the nearest 0.1 foot using a decontaminated steel tape. Water level and well depth measurements were used to calculate the volume of water in each well and the volume of water necessary to purge the well.

A minimum of three to five well volumes were purged from each well prior to sampling. Measurements of pH, specific conductance, temperature, and turbidity were taken after each well volume was purged to ensure that the groundwater characteristics had stabilized before sampling. These measurements were recorded in a field logbook and are provided in Table 3-6. Purge water was contained and handled as described in Section 3.7.

During the groundwater sampling event, a low flow well purging and sampling technique was employed. The sampling methodology was developed in response to conversations with USEPA Region IV personnel in Athens, Georgia. A peristaltic pump (GeoPump), with the intake set two to three feet into the static water column, was used to purge each of the wells. While purging groundwater from each of the monitoring wells, a flow rate of less than 0.25 gpm was maintained. Samples collected for both organic and metal analyses were obtained directly from the pump discharge. The Teflon™ tubing was decontaminated with a Liquinox soap solution and thoroughly rinsed with deionized water (refer to Section 3.6 for decontamination procedures). A dedicated one-foot section of silicon pump-head tubing was used during purge and sampling activities at each well. Rinsate blanks were collected from the Teflon™ and silicon tubing to verify that proper decontamination procedures were being followed.

Preparation of groundwater samples incorporated procedures similar to those described for soil samples. Sample information, including well number, sample identification, time and date of sample collection, samplers, analytical parameters, and required laboratory turnaround time, was recorded in a field logbook and on the sample labels. Chain-of-custody documentation (provided in Appendix D) accompanied the samples to the laboratory.

3.3.7 Analytical Program

Groundwater samples from three existing shallow wells, one newly installed shallow well, two newly installed deep wells, and four temporary wells were submitted for laboratory analysis from Site 43. Samples were analyzed for full TCL organics, TAL total metals, total suspended solids (TSS), and total dissolved solids (TDS). In addition, the groundwater sample obtained from 43-GW04DW was also analyzed for TAL dissolved metals. Table 3-7 provides a summary of groundwater samples submitted for laboratory analysis during the groundwater investigation. The groundwater samples were analyzed using Contract Laboratory Program (CLP) protocols and Level IV data quality.

3.3.8 Quality Assurance and Quality Control

Field QA/QC samples were also submitted for analyses during the groundwater investigation. These samples included trip blanks, equipment rinsates, and duplicates. Equipment rinsates were collected from the peristaltic pump and Teflon™ tubing after decontamination was completed and prior to reuse. Section 3.2.5 provides a summary of QA/QC samples collected during the investigation. Table 3-8 summarizes the QA/QC sampling program employed for the groundwater investigation conducted at Site 43.

3.3.9 Field Screening and Air Monitoring

Air monitoring and field screening procedures for volatile organic vapors implemented at Site 43 included the screening of well heads and the purged groundwater with a PID. Measurements obtained in the field were recorded in a field logbook. Prior to daily monitoring, the field

instruments were calibrated and documentation was recorded in a field logbook and on calibration forms.

3.4 Surface Water and Sediment Investigations

An overview of the surface water and sediment investigations conducted at Site 43 is provided in this section. Surface water and sediment samples were collected at Site 43 during May of 1995. The subsections which follow describe the surface water and sediment sampling locations, sampling procedures, analytical program, and quality assurance and quality control program for Site 43.

3.4.1 Sampling Locations

A total of 6 surface water and 12 sediment samples were collected at Site 43 with each sampling station yielding one surface water and two sediment samples. Two of the sampling stations were located in Edwards Creek and four were located in Strawhorn creek, a tributary to Edwards Creek. Figure 3-5 depicts the locations of the surface water and sediment sampling locations. Surface water samples were assigned the designation "SW" and "SD" was specified for identification of sediment samples.

3.4.2 Sampling Procedures

At each of the six surface water sampling stations, samples were collected by dipping containers directly into the water. Samples to be analyzed for volatiles were obtained first, samples for additional analytical fractions collected immediately following. Care was taken to avoid excessive agitation that could result in loss of VOCs. Water quality readings were taken at each sampling station (i.e., pH, dissolved oxygen, salinity, specific conductance, and temperature). The water quality readings compiled during the surface water and sediment investigation are presented in Table 3-9.

Sediment samples were collected below the aqueous layer by driving a sediment corer, equipped with a disposable tube, into the sediments. The sediment was extruded from the disposable sampling tube and placed into the appropriate sample containers. Sampling containers were provided by the laboratory and certified to be contaminant free. The volatile fraction was collected first, followed by the remaining analytical parameters. Samples to be analyzed for TCL semivolatiles, pesticides, PCBs, total organic carbon (TOC), and TAL metals were thoroughly homogenized before the sample jars were filled. The first six inches of sediment at each station were submitted for analyses separately from sediments collected in the 6- to 12-inch depth range. Surface water and sediment samples were collected at downstream sampling locations first. All sample locations were marked by placing a pin flag or wooden stake at the nearest point along the bank.

3.4.3 Analytical Program

The analytical program at Site 43 was intended to assess the nature and extent of contamination in surface waters and sediments that may have resulted from past disposal practices. As a result, the analytical program focused on suspected contaminants of concern, based upon knowledge of suspected wastes and the overall quality of surface water and sediment. Both surface water and sediment samples were analyzed for full TCL organics and TAL metals. Surface water samples were also analyzed for TAL dissolved metals and hardness. In addition to organic and inorganic

analyses, sediment samples were also analyzed for TOC and grain size. A summary of the surface water and sediment analytical program is provided in Table 3-10.

3.4.4 Quality Assurance and Quality Control

Field QA/QC samples were collected during the surface water and sediment investigation at Site 43, including duplicate samples, equipment rinsate samples, and trip blanks. Table 3-11 provides a summary of the QA/QC sampling program conducted during the surface water and sediment investigation. Section 3.2.5 lists the various QA/QC samples collected during the sampling program at Site 43 and the frequency at which they were obtained.

3.5 Ecological Investigation

A two-pronged ecological investigation, consisting of a habitat evaluation and a bioassay study, was conducted at Site 43. During the habitat evaluation, dominant vegetation types and species were identified in the field; those plants that could not be readily identified were collected for further examination in the office. Amphibians, reptiles, birds, and mammals were also identified as visual sightings or evidence allowed. In many cases, the animals themselves were not seen, but scat, tracks, feeding areas, or remains were noted. From this information, ecological communities were established and biohabitat maps developed (refer to Section 2.0).

The bioassay study was conducted in a laboratory environment, using surface water and sediment samples that were retained from Site 43. A seven-day survival and growth study of fathead minnows was performed with each of the surface water samples. The tests were conducted with sample dilutions of 100 percent, 50 percent, 25 percent, 12.5 percent, and 6.25 percent. A control sample that consisted of 100 percent dilution water was also tested. Survival of the minnows was recorded daily and growth of the minnows (i.e., weight gain or loss) was recorded at the end of seven days.

In addition to the surface water test, a 10-day survival and growth bioassay study was conducted using the sediments retained from Site 43. During the sediment bioassay tests, the overlying water was replaced twice daily. The sediment, however, was not replaced or diluted during the tests. A control sediment sample was also tested in order to statistically correlate sediment findings with the presence or absence of contamination. The control sample was retained from an area within MCB, Camp Lejeune that is not known or suspected to have received contamination. The survival and growth of the introduced amphipods were recorded at the end of the 10 days. Results from the bioassay study are provided in Appendix W.

3.6 Decontamination Procedures

Decontamination procedures performed in the field were initiated in accordance with USEPA Region IV SOPs. Sampling and drilling equipment were divided into two decontamination groups, heavy equipment and routine sample collection equipment. Heavy equipment included the drill rig, hollow-stem augers, and drill and sampling rods. Routine sample collection equipment included split spoons, stainless steel core barrels (used with the GeoProbe™), and stainless steel spoons and bowls, and Teflon™ tubing.

The following procedures were implemented for heavy equipment:

- Removal of caked-on soil with brush

- Steam clean with high-pressure steam
- Air dry

The following procedures were implemented for routine sample collection equipment:

- Clean with distilled water and laboratory detergent (Liquinox soap solution)
- Rinse thoroughly with distilled water
- Rinse twice with isopropyl alcohol
- Air dry
- Wrap in aluminum foil, if appropriate

Temporary decontamination pads, constructed of wood and plastic, were constructed to prevent spillage of fluids onto the ground surface. Decontamination fluids generated during the field program were containerized and handled according to the procedures outlined in Section 3.8.

3.7 Investigation Derived Waste (IDW) Handling

Field investigation activities at Site 43 resulted in the generation of various IDW. This IDW included drilling mud, soil cuttings, well development and purge water, and solutions used to decontaminate non-disposable sampling equipment. The general management techniques utilized for the IDW were:

- Collection and containerization of IDW material.
- Temporary storage of IDW while awaiting confirmatory analytical data.
- Final disposal of aqueous and solid IDW material.

The management of the IDW was performed in accordance with guidelines developed by the USEPA Office of Emergency and Remedial Response, Hazardous Site Control Division (USEPA, 1992). Both the IDW soils and water were returned, based on confirmatory analytical data, to their respective source areas. Contaminated wastewater was sent off site to a licensed hazardous waste disposal facility. Appendix F provides information regarding the management and disposal of the IDW.

3.8 References

American Society for Testing and Materials (ASTM). 1990a. Standard Test Method for Particle Size Analysis of Soils. ASTM D-422-63 (Reapproved 1990). American Society for Testing and Materials, Philadelphia, Pennsylvania.

American Society for Testing and Materials (ASTM). 1990b. Test Method for Hydraulic Conductivity of Saturated Porous Materials Using a Flexible Wall Permeameter. ASTM D-5084-90. American Society for Testing and Materials, Philadelphia, Pennsylvania.

American Society for Testing and Materials (ASTM). 1993a. Standard Practice for Description and Identification of Soils (Visual Manual Procedure). ASTM D-2488-93. American Society for Testing and Materials, Philadelphia, Pennsylvania.

American Society for Testing and Materials (ASTM). 1993b. Standard Test Method for Liquid Limit, Plastic Limit, and Plasticity Index of Soils. ASTM D-4418-93. American Society for Testing and Materials, Philadelphia, Pennsylvania.

American Society for Testing and Materials (ASTM). 1994. Standard Practice for Thin-Walled Tube Geotechnical Sampling of Soils. ASTM D-1587-94. American Society for Testing and Materials, Philadelphia, Pennsylvania.

Baker Environmental, Inc. January 1994a. Site Inspection Report - Site 43, Agan Street Dump. Final. Prepared for the Department of the Navy, Naval Facilities Engineering Command, Atlantic Division, Norfolk, Virginia. January 1994.

Baker Environmental, Inc. 1994b. Remedial Investigation/Feasibility Study Work Plan for Operable Unit No. 6 (Sites 43, 43, 44, 54, and 86), Marine Corps Base Camp Lejeune, North Carolina. Final. Prepared for the Department of the Navy, Naval Facilities Engineering Command, Atlantic Division, Norfolk, Virginia. December 1994.

Naval Energy and Environmental Support Activity (NEESA). 1988. Sampling and Chemical Analysis Quality Assurance Requirements for the Navy Installation Restoration Program. Department of the Navy, Naval Energy and Environmental Support Activity, Port Hueneme, California. NEESA 20.2-047B.

United States Environmental Protection Agency (USEPA). 1991. National Functional Guidelines for Organic Data Review. Draft. USEPA Contract Laboratory Program. June 1991.

United States Environmental Protection Agency (USEPA). 1992. Guide to Management of Investigation-Derived Wastes. "Standard Default Exposure Factors" Interim Final. Office of Emergency and Remedial Response Hazardous Site Control Division. Washington, D.C. OS-220W. April 1992.

Water and Air Research, Inc. (WAR). 1983. Initial Assessment Study of Marine Corps Base Camp Lejeune, North Carolina. Prepared for the Department of the Navy, Naval Energy and Environmental support Activity, Port Hueneme, California. April 1983.

SECTION 3.0 TABLES

TABLE 3-1

SOIL SAMPLING SUMMARY
 TEST BORINGS
 SITE 43, AGAN STREET DUMP
 REMEDIAL INVESTIGATION, CTO-0303
 MCAS, NEW RIVER, NORTH CAROLINA

Sample Location	Depth of Borehole (feet, below ground surface)	Sampling Interval (feet, below ground surface)	Analytical Parameters					
			TCL Pest/PCB	TAL Metals	TCL VOC	TCL SVOC	Duplicate Sample	MS/MSD
43-DA1-SB01	5	0-1		X		X		
		1-3		X		X		
43-DA1-SB02	3	0-1		X		X		
		1-3		X		X		
43-DA1-SB03	5	0-1	X	X	X	X		
		1-3	X	X	X	X		
43-DA2-SB01	3	0-1	X	X	X	X		
		1-3	X	X	X	X		
43-DA2-SB02	3	0-1		X		X	X	X
		1-3		X		X		
43-MA-SB01	5	0-1		X		X		
		1-3		X		X		
43-MA-SB02	7	0-1		X		X		
		3-5		X		X	X	X
43-MA-SB03	5	0-1	X	X	X	X		
		1-3	X	X	X	X		
43-MA-SB04	5	0-1		X		X		
		1-3		X		X		
43-MA-SB05	7	0-1		X		X		
		3-5		X		X		
43-OA-SB01	5	0-1	X	X	X	X		
		1-3	X	X	X	X		
43-OA-SB02	3	0-1	X	X	X	X		
		1-3	X	X	X	X		
43-OA-SB03	3	0-1	X	X	X	X		
		1-3	X	X	X	X		
43-OA-SB04	3	0-1		X		X	X	X
		1-3		X		X	X	
43-OA-SB05	5	0-1	X	X	X	X		
		3-5	X	X	X	X	X	
43-OA-SB06	6	0-1		X		X		
		2-4		X		X		
43-OA-SB07	3	0-1		X		X		
43-WA-SB01	5	0-1	X	X	X	X		
		1-3	X	X	X	X		
43-WA-SB01A	1	0-1				X		
43-WA-SB01B	1	0-1				X		

TABLE 3-1 (Continued)

**SOIL SAMPLING SUMMARY
TEST BORINGS
SITE 43, AGAN STREET DUMP
REMEDIAL INVESTIGATION, CTO-0303
MCAS, NEW RIVER, NORTH CAROLINA**

Sample Location	Depth of Borehole (feet, below ground surface)	Sampling Interval (feet, below ground surface)	Analytical Parameters					
			TCL Pest/PCB	TAL Metals	TCL VOC	TCL SVOC	Duplicate Sample	MS/MSD
43-WA-SBO1C	1	0-1				X		
43-WA-SBO1A1	1	0-1				X		
43-WA-SB01A2	1	0-1				X		
43-WA-SB01A3	1	0-1				X		
43-WA-SB01A4	1	0-1				X		
43-WA-SB02	5	0-1		X		X		
		3-5		X		X		
43-WA-SB03	5	0-1		X		X		
		1-3		X		X		
43-BB-SB01 ⁽¹⁾	7	0-1	X	X	X	X		
		3-5	X	X	X	X		
43-BB-SB02 ⁽¹⁾	3	0-1	X	X	X	X		
		1-3	X	X	X	X		
43-BB-SB-03 ⁽¹⁾	7	0-1	X	X	X	X		
		1-3	X	X	X	X		

Notes: ⁽¹⁾ Background or control sample location.

TABLE 3-2

**SOIL SAMPLING SUMMARY
 MONITORING WELL TEST BORINGS
 SITE 43, AGAN STREET DUMP
 REMEDIAL INVESTIGATION, CTO-0303
 MCAS, NEW RIVER, NORTH CAROLINA**

Sample Location	Depth of Borehole (feet, below ground surface)	Sampling Interval (feet, below ground surface)	Analytical Parameters					
			TCL Pest./PCB	TAL Metals	TCL VOA	TCL SVOA	Engineering Parameters ⁽¹⁾	Duplicate Sample
43-GW01DW	5	0-1	X	X	X	X	X	X
		1-3	X	X	X	X		

Notes: ⁽¹⁾ Engineering Parameters include grain size and Atterberg limits of composite sample.

TABLE 3-3

QUALITY ASSURANCE/QUALITY CONTROL SAMPLING PROGRAM
 SOIL INVESTIGATION
 SITE 43, AGAN STREET DUMP
 REMEDIAL INVESTIGATION, CTO-0303
 MCAS, NEW RIVER, NORTH CAROLINA

QA/QC Sample ⁽¹⁾	Frequency of Collection	Number of Samples	Analytical Parameters
Trip Blanks ⁽²⁾	One per cooler	4	TCL Volatiles
Field Blanks ⁽³⁾	One per event	3	TCL VOC, TCL SVOC, TCL Pest/PCB, TAL Metals
Equipment Rinsates ⁽⁴⁾	One per day	4	TCL VOC, TCL SVOC, TCL Pest/PCB, TAL Metals
Field Duplicates ⁽⁵⁾	10% of sample frequency	6	TCL VOC, TCL SVOC, TCL Pest/PCB, TAL Metals

- Notes: (1) QA/QC sample types defined in Section 3.25 in text.
 (2) Trip blanks submitted with coolers which contained samples for volatile analysis. Samples analyzed for TCL Volatiles only.
 (3) Field blank collected during the soil investigation from water source used for decontamination.
 (4) Equipment rinsates collected from various sampling equipment (e.g., stainless steel core barrels).
 (5) Field duplicate samples presented in Appendix J.

TABLE 3-4

SUMMARY OF WELL CONSTRUCTION DETAILS
 SITE 43, AGAN STREET DUMP
 REMEDIAL INVESTIGATION, CTO-0303
 MCAS, NEW RIVER, NORTH CAROLINA

Well No.	Date Installed	Top of PVC Casing Elevation (feet, above msl) ⁽¹⁾	Ground Surface Elevation (feet, above msl)	Boring Depth (feet, below ground surface)	Well Depth (feet, below ground surface)	Screen Interval Depth (feet, below ground surface)	Sand Pack Interval Depth (feet, below ground surface)	Bentonite Interval Depth (feet, below ground surface)
43-PZ01	4/11/95	7.47	5.07	10.5	10.6	0.6-10.6	NA	0-0.5
43-GW01DW	3/13/95	7.43	5.33	62	61	56-61	53-62	49-53
43-GW04	3/23/95	9.03	7.20	17	16	1-16	0.5-17	0.0.5
43-GW04DW	3/11/95	7.84	6.0	65	64	59-64	55-65	49-55

Notes:

⁽¹⁾ msl - mean sea level

Horizontal positions are referenced to N.C. State Plane Coordinate System (NAD 27) CF = 0.9999216 from USMC Monument Toney.

Vertical datum NGVD 29.

NA - Not Applicable

TABLE 3-5

SUMMARY OF WATER LEVEL MEASUREMENTS
 SITE 43, AGAN STREET DUMP
 REMEDIAL INVESTIGATION, CTO-0303
 MCAS, NEW RIVER, NORTH CAROLINA

Well No.	Top of PVC Casing Elevation (feet, above msl) ⁽¹⁾	Depth to Groundwater (feet, below top of casing) March 25, 1995	Depth to Groundwater (feet, below top of casing) April 23, 1995	Depth to Groundwater (feet, below top of casing) May 6, 1995	Groundwater Elevation (feet, above msl) March 25, 1995	Groundwater Elevation (feet, above msl) April 23, 1995	Groundwater Elevation (feet, above msl) May 6, 1995
43-GW01	8.26	4.16	6.74	7.04	4.10	1.52	1.22
43-GW01DW ⁽²⁾	7.43	4.21	5.16	5.43	3.22	2.27	2.00
43-GW02	8.03	5.19	7.23	7.80	2.84	0.80	0.23
43-GW03	6.58	4.28	5.83	5.28	2.30	0.75	1.30
43-GW04	9.03	4.46	5.90	6.36	4.57	3.13	2.67
43-GW04DW ⁽²⁾	7.84	4.07	5.07	5.39	3.77	2.77	2.45
43-SG01 ⁽³⁾	3.94	NA	Dry	Dry	NA	NA	NA
43-SG02 ⁽³⁾	3.15	NA	0.94	0.98	NA	2.21	2.17
43-SG03 ⁽³⁾	3.19	NA	0.86	0.96	NA	2.33	2.23
43-PZ01 ⁽⁴⁾	7.47	NA	NA	6.12	NA	NA	1.35

Notes:

- ⁽¹⁾ msl - mean sea level
 - ⁽²⁾ Deep monitoring well
 - ⁽³⁾ Staff gauge
 - ⁽⁴⁾ Piezometer
- NA - Data not available

TABLE 3-6

SUMMARY OF GROUNDWATER FIELD PARAMETERS
 SITE 43, AGAN STREET DUMP
 REMEDIAL INVESTIGATION, CTO-0303
 MCAS, NEW RIVER, NORTH CAROLINA

Well No.	Depth of Well (ft.)	Purge Volume (gals.)	Field Parameters				
Date of Measurement			Well Volume	Specific Conductance at 25°C ⁽²⁾ (micromhos/cm)	Temperature (°C)	pH (S.U.)	Turbidity (T.U.)
43-GW01	14.86	13.05	1.0	448.0	18.0	7.01	35.0
4/4/95			2.0	480.0	16.0	7.11	122.0
			3.0	456.0	16.0	7.07	173.0
			4.0	442.0	15.0	7.07	>200.0
			6.0	401.0	17.0	6.92	12.0
			7.0	399.0	15.0	6.92	9.0
			8.0	360.0	16.0	6.87	7.3
			9.0	372.0	16.0	6.86	6.9
43-GW01DW	62.75	28.0	0.25	588.0	19.0	7.57	22.0
4/5/95			0.50	638.0	18.0	7.67	23.5
			0.75	632.0	18.0	7.60	15.0
			1.00	632.0	18.0	7.61	7.8
			1.25	632.0	18.0	7.62	4.8
			1.50	632.0	18.0	7.65	2.8
			1.75	661.0	18.0	7.70	2.1
			2.00	661.0	18.0	7.75	1.2
			2.25	616.0	19.0	7.64	1.2
			2.50	644.0	18.0	7.59	1.1
			2.75	661.0	18.0	7.59	1.0
			3.00	661.0	18.0	7.58	0.9
43-GW02	13.92	8.61	1.0	159.0	15.0	4.89	10.1
4/7/95			2.0	159.0	15.0	4.92	9.5
			3.0	147.0	15.0	4.98	8.8
			4.0	153.0	15.0	4.98	12.8
			5.5	153.0	15.0	4.95	27.6
			7.0	144.0	16.0	4.95	7.0
43-GW03	15.25	8.25	1.0	365.0	14.0	6.23	27.8
4/6/95			2.0	333.0	14.0	4.23	23.5
			3.0	315.0	14.0	3.84	8.5
			4.0	302.0	14.0	NA	4.8
			5.0	302.0	14.0	NA	3.3

TABLE 3-6 (Continued)

SUMMARY OF GROUNDWATER FIELD PARAMETERS
 SITE 43, AGAN STREET DUMP
 REMEDIAL INVESTIGATION, CTO-0303
 MCAS, NEW RIVER, NORTH CAROLINA

Well No.	Depth of Well (ft.)	Purge Volume (gals.)	Field Parameters				
Date of Measurement			Well Volume	Specific Conductance at 25°C ⁽²⁾ (micromhos/cm)	Temperature (°C)	pH (S.U.)	Turbidity (T.U.)
43-GW04	18.89	15.54	1.0	220.0	14.0	6.12	15.3
4/6/95			2.0	226.0	14.0	6.12	12.5
			3.0	226.0	14.0	6.11	11.2
			4.0	226.0	14.0	6.11	10.7
			5.0	233.0	14.0	6.10	10.0
			6.0	233.0	14.0	6.13	9.2
			7.0	233.0	14.0	6.12	8.9
43-GW04DW	66.5	28.76	0.5	413.0	17.0	9.36	66.0
4/4/95			1.0	424.0	17.0	9.00	20.0
			1.5	419.0	18.0	8.80	12.5
			1.75	436.0	19.0	8.67	7.5
			2.0	453.0	19.0	8.51	6.2
			2.25	453.0	19.0	8.53	5.5
			2.5	462.0	20.0	8.45	4.2
			2.75	462.0	20.0	8.23	3.9
			3.0	464.0	21.0	8.18	3.2
43-GW06DW	75.0	33.54	0.25	480.0	16.0	7.57	0.7
4/8/95			0.50	472.0	17.0	7.24	4.37
			0.75	483.0	17.0	7.59	3.20
			1.00	483.0	17.0	7.27	3.00
			1.25	489.0	17.0	7.58	2.58
			1.50	507.0	17.0	7.05	1.87
			1.75	507.0	17.0	7.56	1.5
			2.00	507.0	17.0	7.40	1.4
			2.25	507.0	17.0	7.35	1.1
			2.50	507.0	17.0	7.56	0.9
			2.75	507.0	17.0	7.55	0.7
3.00	507.0	17.0	7.52	0.7			
43-TW01	9.83	NA	NA	459.0	14.0	5.25	100.2
4/5/95			NA	466.0	14.0	5.09	29.2
			NA	492.0	12.0	5.03	5.5
			NA	485.0	12.0	5.04	9.6

TABLE 3-6 (Continued)

SUMMARY OF GROUNDWATER FIELD PARAMETERS
 SITE 43, AGAN STREET DUMP
 REMEDIAL INVESTIGATION, CTO-0303
 MCAS, NEW RIVER, NORTH CAROLINA

Well No.	Depth of Well (ft.)	Purge Volume (gals.)	Field Parameters				
			Well Volume	Specific Conductance at 25°C ⁽²⁾ (micromhos/cm)	Temperature (°C)	pH (S.U.)	Turbidity (T.U.)
43-TW02	8.82	NA	NA	361.0	13.0	5.92	>200.0
4/6/95			NA	464.0	13.0	6.44	NA
			NA	489.0	11.0	6.52	56.9
			NA	496.0	11.0	6.53	77.3
			NA	466.0	14.0	6.52	15.5
			NA	466.0	14.0	6.54	7.5
			NA	NA	NA	NA	6.5
43-TW03	9.85	NA	NA	206.0	13.0	4.40	130.0
4/7/95			NA	113.0	14.0	4.73	115.3
			NA	126.0	14.0	4.75	103.2
			NA	126.0	14.0	4.77	14.4
			NA	NA	NA	NA	4.9
43-TW04	9.03	NA	NA	7475.0	18.0	4.23	107.5
4/7/95			NA	7475.0	18.0	4.22	9.5
			NA	7475.0	18.0	4.21	5.9
			NA	7410.0	18.5	4.24	3.7

Notes: S.U. - Standard Units
 T.U. - Turbidity Units
 °C - Degrees Centigrade

TABLE 3-7

**GROUNDWATER SAMPLING SUMMARY
 SITE 43, AGAN STREET DUMP
 REMEDIAL INVESTIGATION, CTO-0303
 MCAS, NEW RIVER, NORTH CAROLINA**

Sample Location	Analytical Parameters								
	TCL VOA	TCL SVOA	TCL Pest/ PCB	TAL Metals	Dissolved TAL Metals	TSS	TDS	Duplicate Sample	MS/ MSD
43-TW01	X	X	X	X		X	X		
43-TW02	X	X	X	X		X	X		
43-TW03	X	X	X	X		X	X		
43-TW04	X	X	X	X		X	X		
43-GW01	X	X	X	X		X	X	X	X
43-GW01DW	X	X	X	X		X	X		
43-GW02	X	X	X	X		X	X		
43-GW03	X	X	X	X		X	X		
43-GW04	X	X	X	X		X	X		
43-GW04DW	X	X	X	X	X	X	X		

Notes: TSS - Total Suspended Solids
 TDS - Total Dissolved Solids

TABLE 3-8

QUALITY ASSURANCE/QUALITY CONTROL SAMPLING PROGRAM
GROUNDWATER INVESTIGATION
SITE 43, AGAN STREET DUMP
REMEDIAL INVESTIGATION, CTO-0303
MCAS, NEW RIVER, NORTH CAROLINA

QA/QC Sample ⁽¹⁾	Frequency of Collection	Number of Samples	Analytical Parameters
Trip Blanks ⁽²⁾	One per cooler	5	TCL Volatiles
Equipment Rinsates ⁽³⁾	One per day	5	TCL VOA, TCL SVOA, TCL Pest/PCB, TAL Metals, TSS, TDS, Dissolved Metals
Field Duplicates ⁽⁴⁾	10% of sample frequency	1	TCL VOA, TCL SVOA, TCL Pest/PCB, TAL Metals, TSS, TDS

- Notes: (1) QA/QC sample types defined in Section 3.38 in text.
(2) Trip blanks submitted with coolers which contained samples for volatile analysis. Samples analyzed for TCL Volatiles only.
(3) Equipment rinsates collected from various sampling equipment (e.g., peristaltic pump).
(4) Field duplicate samples presented in Appendix J.

TABLE 3-9

**SUMMARY OF SURFACE WATER FIELD PARAMETERS
SITE 43, AGAN STREET DUMP
REMEDIAL INVESTIGATION, CTO-0303
MCAS, NEW RIVER, NORTH CAROLINA**

Station	Temperature (°C)	pH (S.U.)	Dissolved Oxygen (mg/L)	Conductivity (umhos/cm)	Salinity (ppt)
43-SHC-SW/SD01	20.1	6.53	3.6	788	0.3
43-SHC-SW/SD02	18.3	6.71	3.7	5,750	3
43-SHC-SW/SD03	18.5-19.5	6.78-6.96	4.2-4.9	6,220-6,610	4-4.8
43-SHC-SW/SD04	20.0-20.3	6.85-7.82	4.6-7.7	10,100-10,600	5.8-7.0
43-EC-SW/SD01	19.9-22.0	8.19	9.9	8,100-9,600	4.6-5.4
43-EC-SW/SD02	21.3-22.0	8.67	13.7	7,500-9,900	4.8-5.0

Notes:

ppt - Parts per Thousand
EC - Edwards Creek
SHC - Strawhorn Creek
SW/SD - Surface Water/Sediment Sample
S.U. - Standard Units
mg/L - Milligrams per Liter
°C - Degrees Centigrade

TABLE 3-10

SURFACE WATER AND SEDIMENT SAMPLING SUMMARY
 SITE 43, AGAN STREET DUMP
 REMEDIAL INVESTIGATION, CTO-0303
 MCAS, NEW RIVER, NORTH CAROLINA

Sample Location	Sampling Interval (inches)	Sample Depth ⁽¹⁾	Analytical Parameters									
			TCL VOA	TCL SVOA	TCL Pest/PCB	TAL Metals	Dissolved TAL Metals	TOC	Grain Size	Water Hardness	Duplicate Sample	MS/MSD
43-EC-SW/SD01	SW	NA	X	X	X	X	X			X	X	X
	SD	0-6"	X	X	X	X		X	X		X	X
	SD	6-12"	X	X	X	X		X				
43-EC-SW/SD02	SW	NA	X	X	X	X	X			X		
	SD	0-6"	X	X	X	X						
	SD	6-12"	X	X	X	X						
43-SHC-SW/SD01	SW	NA	X	X	X	X	X	X	X	X		
	SD	0-6"	X	X	X	X		X				
	SD	6-12"	X	X	X	X						
43-SHC-SW/SD02	SW	NA	X	X	X	X	X			X		
	SD	0-6"	X	X	X	X						
	SD	6-12"	X	X	X	X						
43-SHC-SW/SD03	SW	NA	X	X	X	X	X			X		
	SD	0-6"	X	X	X	X						
	SD	6-12"	X	X	X	X						
43-SHC-SW/SD04	SW	NA	X	X	X	X	X			X		
	SD	0-6"	X	X	X	X		X	X			
	SD	6-12"	X	X	X	X		X				
303-FC-SD01-06	SD	0-6"	X	X	X	X		X	X			

Notes: ⁽¹⁾NA - Not applicable for surface water samples.
 SW - Surface Water
 SD - Sediment
 TOC - Total Organic Carbon

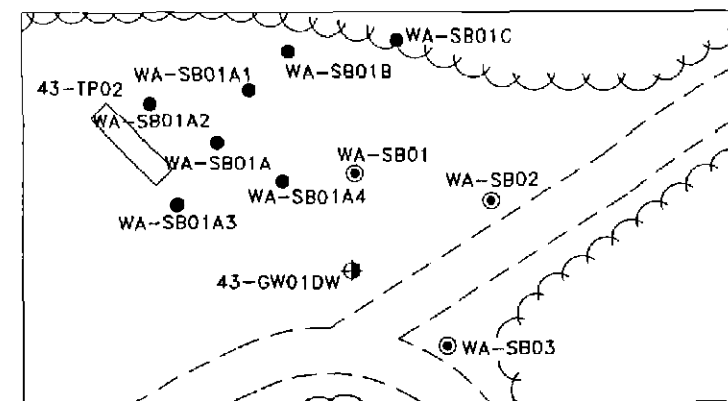
TABLE 3-11

QUALITY ASSURANCE/QUALITY CONTROL SAMPLING PROGRAM
 SURFACE WATER AND SEDIMENT INVESTIGATION
 SITE 43, AGAN STREET DUMP
 REMEDIAL INVESTIGATION, CTO-0303
 MCAS, NEW RIVER, NORTH CAROLINA

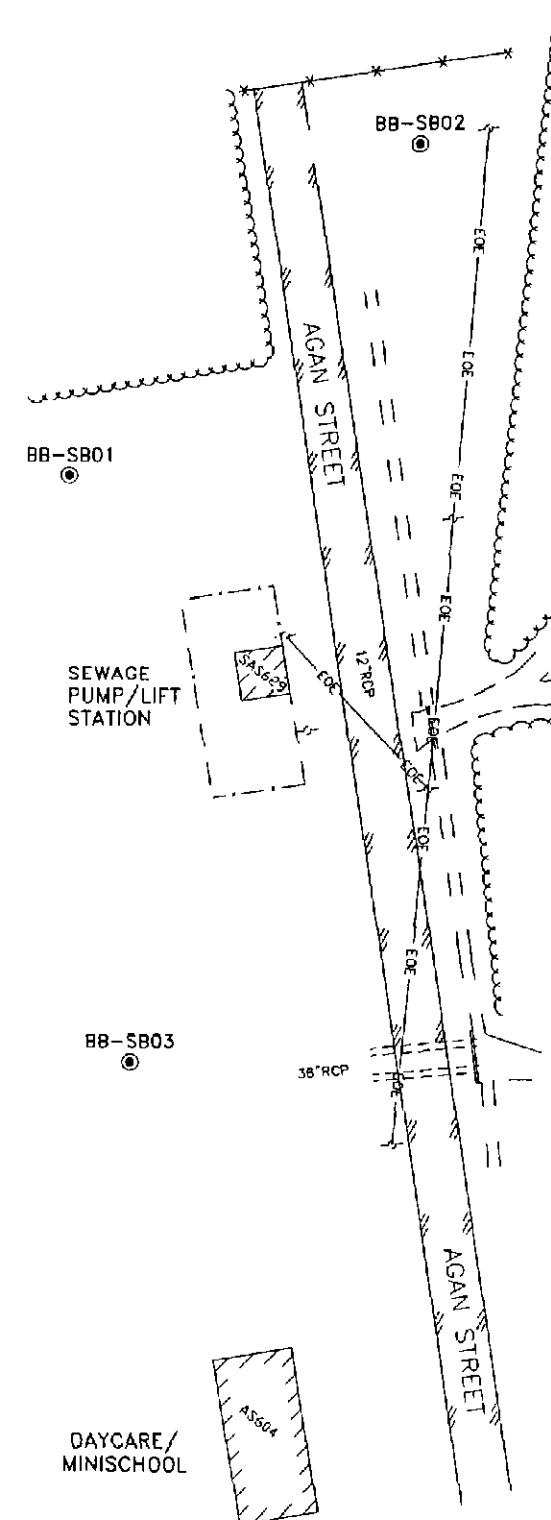
QA/QC Sample ⁽¹⁾	Frequency of Collection	Number of Samples	Analytical Parameters
Trip Blanks ⁽²⁾	One per cooler	2	TCL Volatiles
Equipment Rinsates ⁽³⁾	One per day	1	TCL VOA, TCL TCL Pest/PCB, TAL Metals
Field Duplicates ⁽⁴⁾	10% of sample frequency	3	TCL VOA, TCL SVOA, TCL Pest/PCB, TAL Metals, Dissolved Metals, Hardness

- Notes: (1) QA/QC sample types defined in Section 3.4.4 in text.
 (2) Trip blanks submitted with coolers which contained samples for volatile analysis. Samples analyzed for TCL Volatiles only.
 (3) Equipment rinsates collected from various sampling equipment (e.g., sediment corer).
 (4) Field duplicate samples presented in Appendix J.

SECTION 3.0 FIGURES

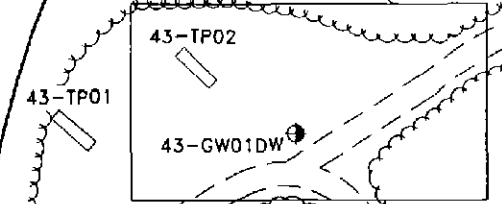


INSERT
1 inch = 30 ft



APPROXIMATE SITE BOUNDARY

SEE INSERT THIS SHEET



1 inch = 60 ft

- LEGEND**
- 43-GW01DW PILOT TEST BORING FOR DEEP MONITORING WELL
 - OA-SB01 SOIL BORING LOCATION
 - WA-SB01A SURFACE SOIL SAMPLING LOCATION
 - 43-TP01 EXPLORATORY TEST PIT LOCATION
 - FLOW DIRECTION OF SURFACE WATER FLOW
 - MARSH
 - OVERHEAD ELECTRIC LINE & UTILITY FOLE
 - FENCE
 - ASPHALT ROAD
 - GRAVEL ROAD OR SOIL PATH
 - EDGE OF CREEK DRAINAGE DITCH OR MARSH
 - TREE LINE
 - STRUCTURE

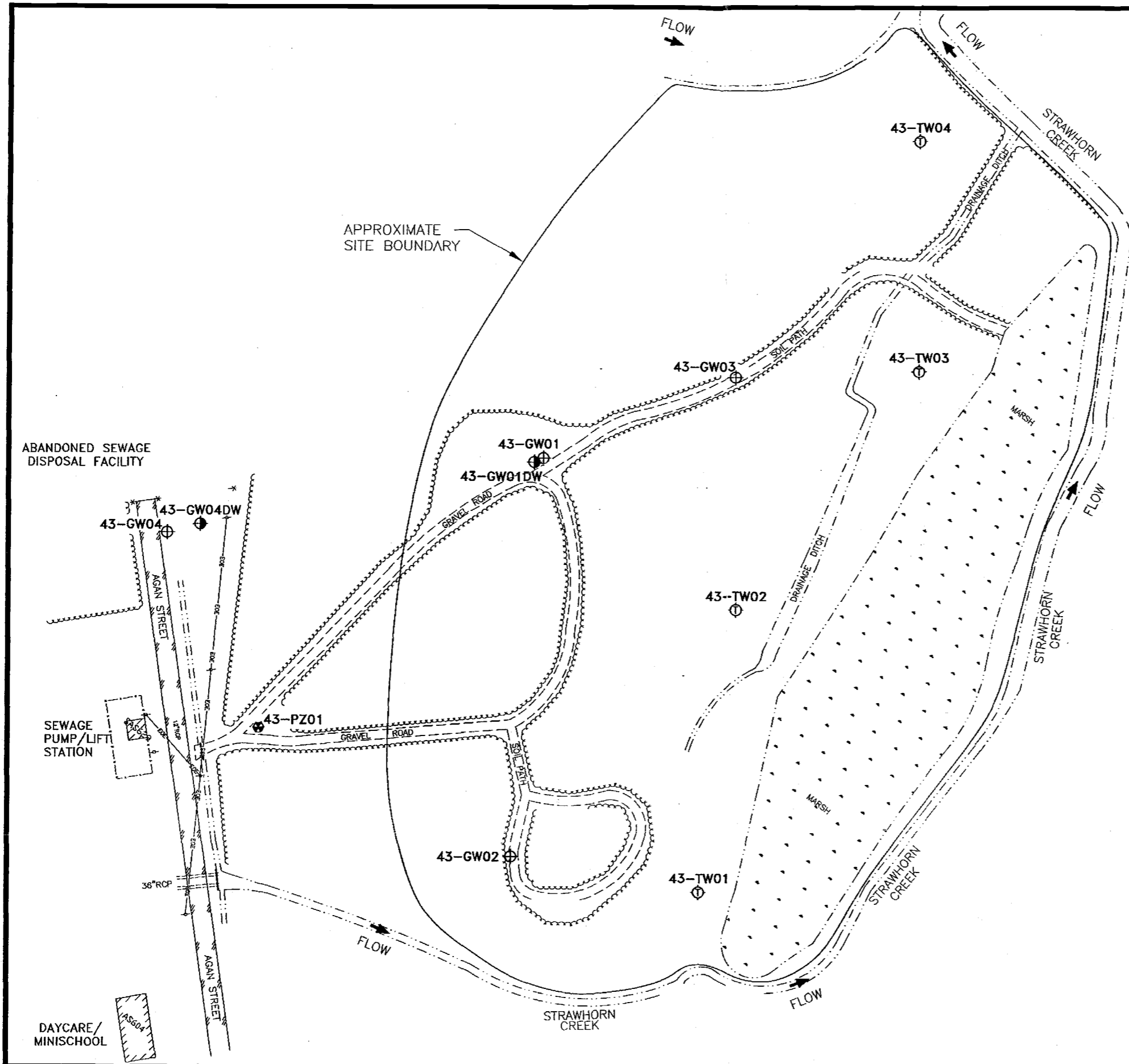
REVISIONS	DRAWN REL	NORTH
	REVIEWED TFT/JEZ	
	S O # 62470-303-0000-07000	
	CADD# 303D76RI	
SOURCE LANTDIV, FEBRUARY 1992 SURVEY BRENT A LANIER AND ASSOCIATES, 1995		

REMEDIAL INVESTIGATION CTO-0303 MARINE CORPS AIR STATION, NEW RIVER NORTH CAROLINA	
BAKER ENVIRONMENTAL, Inc. Coraopolis, Pennsylvania	

Baker Baker Environmental, Inc.	SCALE 1" = 60'	DATE JANUARY 1996
---	----------------	-------------------

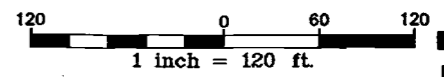
SOIL SAMPLING LOCATIONS SITE 43, AGAN STREET DUMP	FIGURE No 3-1
--	-------------------------

01713Y04X



LEGEND

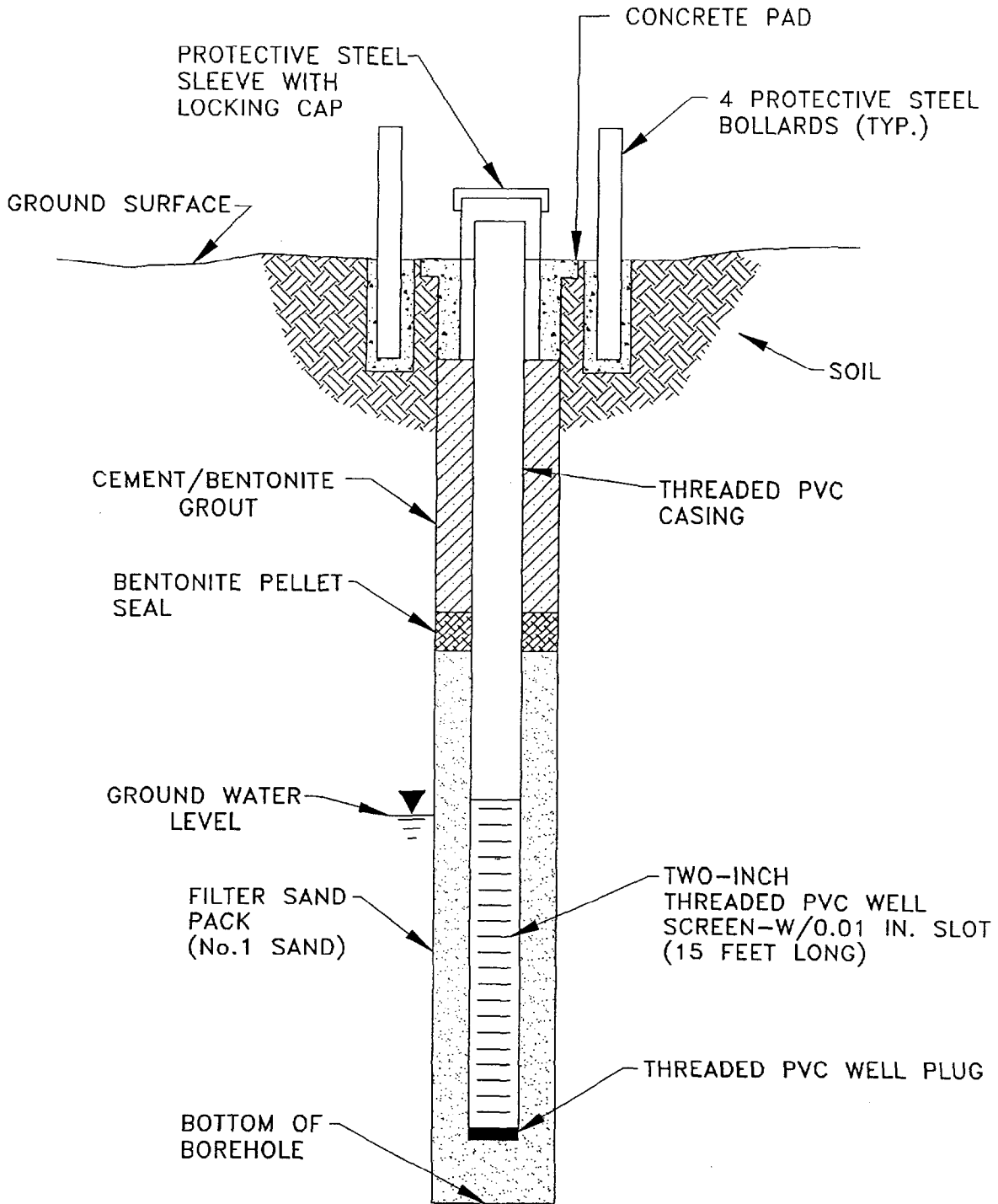
- 43-GW01 SHALLOW MONITORING WELL
- 43-GW01DW DEEP MONITORING WELL
- 43-TW01 TEMPORARY MONITORING WELL
- 43-PZ01 PIEZOMETER
- FLOW DIRECTION OF SURFACE WATER FLOW
- MARSH
- EOE OVERHEAD ELECTRIC LINE & UTILITY POLE
- FENCE
- ASPHALT ROAD
- GRAVEL ROAD OR SOIL PATH
- EDGE OF CREEK, DRAINAGE DITCH OR MARSH
- TREE LINE
- STRUCTURE



Baker
Baker Environmental, Inc.

FIGURE 3-2
MONITORING WELL LOCATIONS
SITE 43, AGAN STREET DUMP
REMEDIAL INVESTIGATION, CTO-0303
MARINE CORPS AIR STATION, NEW RIVER
NORTH CAROLINA

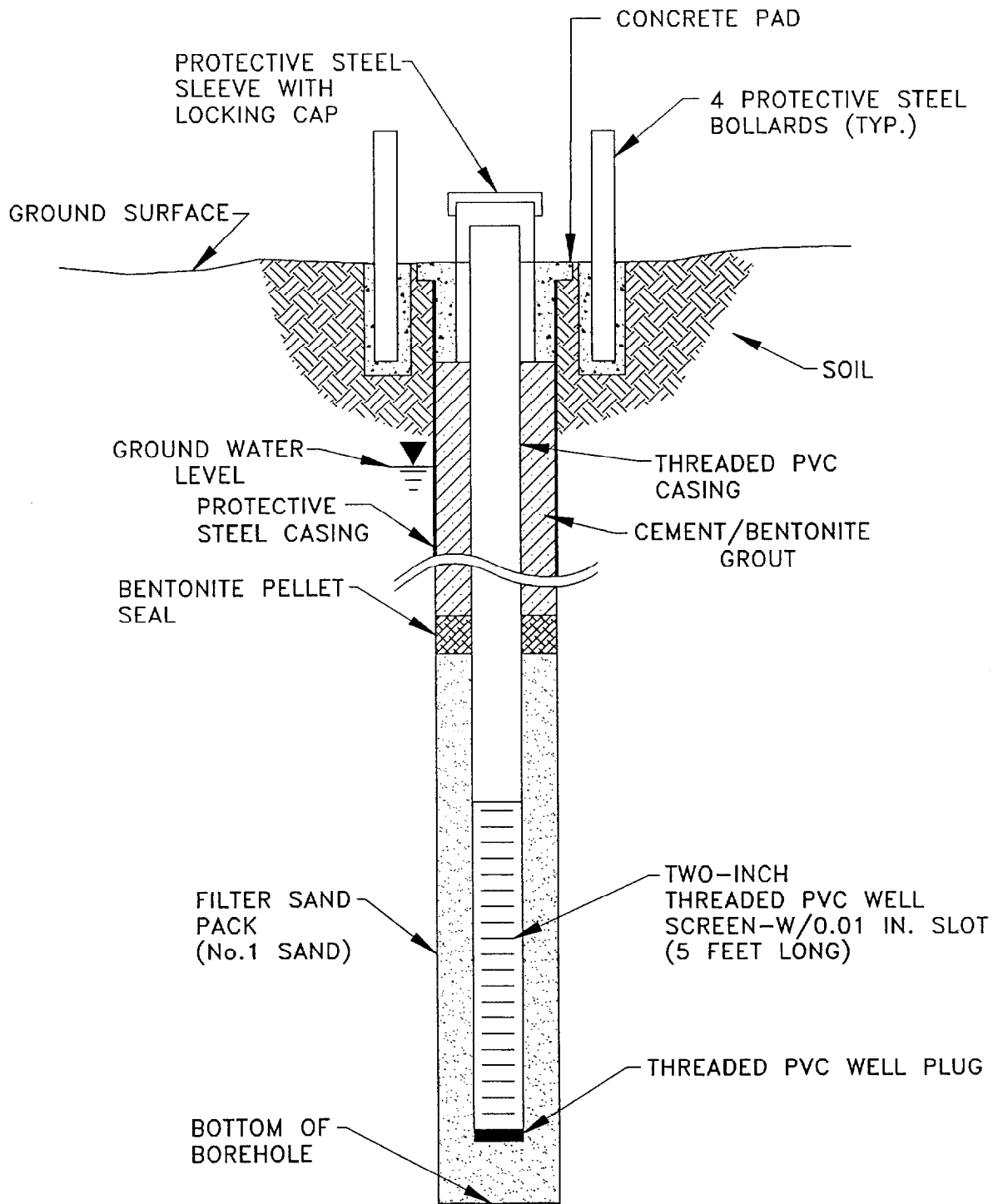
01713405Z



N.T.S.



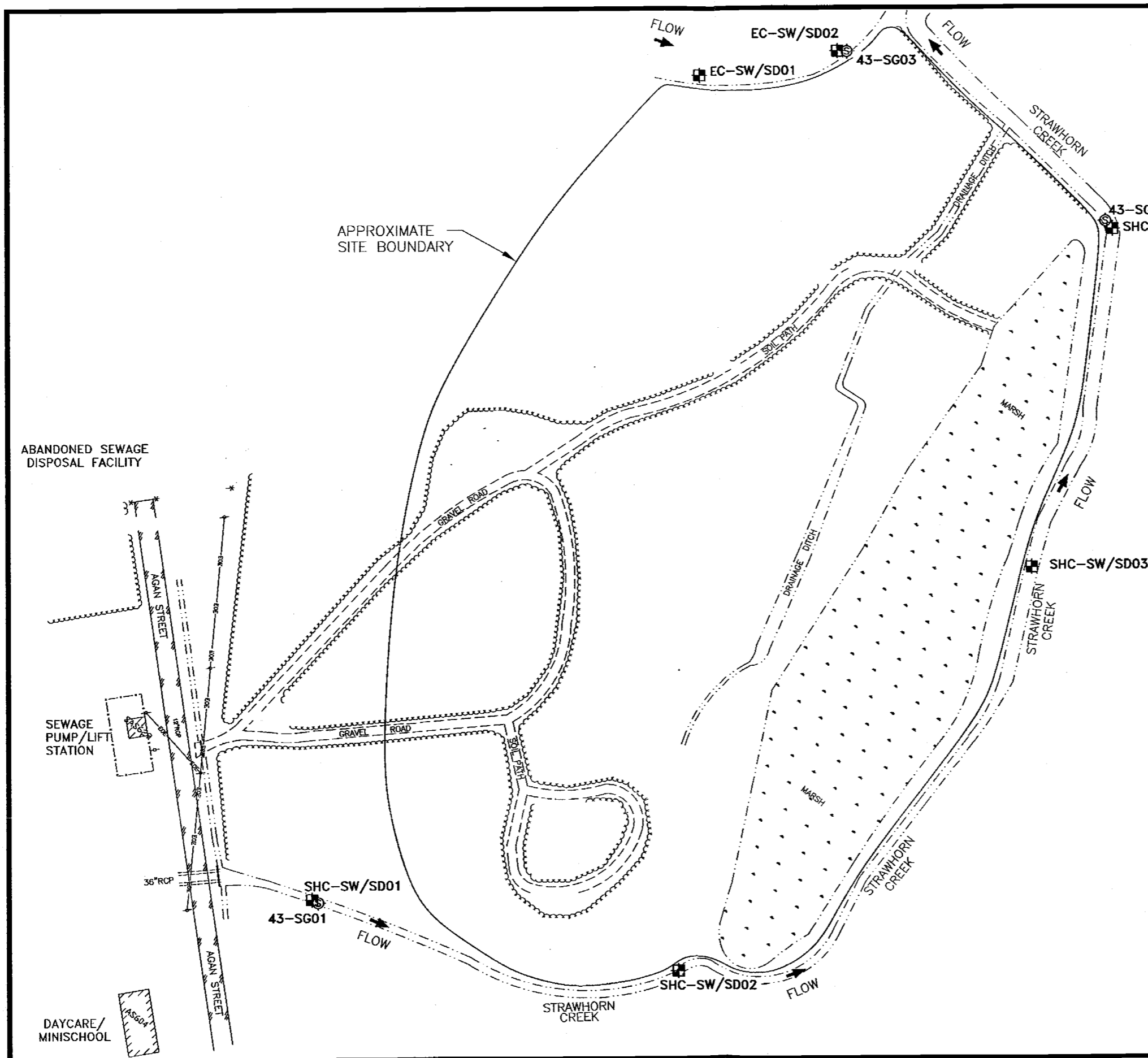
FIGURE 3-3
TYPICAL SHALLOW TYPE II GROUNDWATER
MONITORING WELL CONSTRUCTION DIAGRAM
REMEDIAL INVESTIGATION CTO-0303
MARINE CORPS BASE, CAMP LEJEUNE
NORTH CAROLINA



N.T.S.

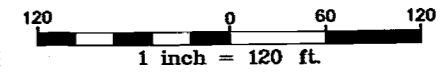


FIGURE 3-4
TYPICAL DEEP TYPE III GROUNDWATER
MONITORING WELL CONSTRUCTION DIAGRAM
REMEDIAL INVESTIGATION CTO-0303
MARINE CORPS BASE, CAMP LEJEUNE
NORTH CAROLINA



LEGEND

- SHC-SW/SD01 SURFACE WATER AND SEDIMENT SAMPLING LOCATION
- 43-SG01 STAFF GAUGE
- FLOW DIRECTION OF SURFACE WATER FLOW
- MARSH
- EOE OVERHEAD ELECTRIC LINE & UTILITY POLE
- FENCE
- ASPHALT ROAD
- GRAVEL ROAD OR SOIL PATH
- EDGE OF CREEK, DRAINAGE DITCH OR MARSH
- TREE LINE
- STRUCTURE



Baker
Baker Environmental, Inc.

FIGURE 3-5
SURFACE WATER AND SEDIMENT
SAMPLING LOCATIONS
SITE 43, AGAN STREET DUMP
REMEDIAL INVESTIGATION, CTO-0303
MARINE CORPS AIR STATION, NEW RIVER
NORTH CAROLINA

01713Y06Z

4.0 NATURE AND EXTENT OF CONTAMINATION

This section presents the nature and extent of contamination at OU No. 6, Site 43. The objective of this section is to characterize the nature and extent of contamination which may be present as a result of past waste management activities. The characterization of contaminants at Site 43 was performed by sampling and laboratory analysis of soil, groundwater, surface water, and sediment environmental media. Appendices G through M present the Sampling Summaries; Data and Frequency Summaries; Statistical Summaries; Field Duplicate Summaries; Quality Assurance and Quality Control Summaries; TCLP, RCRA, and TPH Results; and Engineering Parameter Results for the various media at Site 43.

4.1 Data Quality

The majority of data generated during the RI was submitted for third-party validation; wet chemistry, TCLP, RCRA characteristics, TPH, grain size, and permeability results were not validated. The usability of the data was determined by the third party data validator, Heartland Environmental Services, Inc. Procedures stipulated by the National Functional Guidelines for Organic (USEPA, 1991) and Inorganic Analyses (USEPA, 1988) were observed during the validation process. Validation of the analytical data serves to reduce the inherent uncertainties associated with its usability. Data qualified as "J" were retained as estimated. Estimated analytical results within a data set are common and considered to be usable by the USEPA (USEPA, 1989). Data may be qualified as estimated for several reasons including an exceedance of holding times, high or low surrogate recovery or intra-sample variability. In addition, values may be assigned an estimated "J" qualifier if the reported value is below the Contract Required Detection Limit (CRDL) or the Contract Required Quantitation Limit (CRQL). Data assigned a rejected "R" qualifier was excluded from the usable data set. Under these conditions estimated positive results were designated with "J" qualifiers and rejected data were assigned "R" qualifiers. Table 4-1 provides a summary of all rejected Site 43 data.

Additional qualifiers were employed during the validation of data. The "NJ" qualifier denotes that a compound was tentatively identified, but the reported value may not be accurate or precise. Compounds that were not detected and had inaccurate or imprecise quantitation limits were assigned the "UJ" qualifier.

4.1.1 Data Management and Tracking

The management and tracking of data, from time of field collection to receipt of validation report, is of primary importance to the overall quality of laboratory analytical results. Field samples and their corresponding analyses were recorded on chain-of-custody forms, provided in Appendix D. Chain-of-custody forms were compared to the Field Sampling and Analysis Plan (Baker, 1994); this comparison was used to verify that appropriate laboratory analyses had been requested. Upon receipt of laboratory analytical results, a further comparison was performed to verify that each sample received by the laboratory was analyzed for the correct parameters. Finally, the validation report was compared to the requested laboratory analyses.

The management and tracking of data was used to determine the following items:

- Identify and correct chain-of-custody discrepancies prior to laboratory analysis
- Verify the receipt of all samples by the laboratory

- Confirm that requested sample analyses and validation were performed
- Ensure the delivery of a complete data set

4.2 Non-Site Related Analytical Results

Many of the organic compounds and inorganic analytes detected in environmental media at Site 43 may be attributable to non-site related conditions or activities. Two primary sources of non-site related analytical results include laboratory contaminants and naturally-occurring inorganic species. In addition, non-site related operational activities and conditions may contribute to "on-site" contamination. A discussion of non-site related analytical results for Site 43 is provided in the subsections which follow.

4.2.1 Laboratory Contaminants

Field blank and trip blank samples provide a measure of contamination that has been introduced into a sample set during the collection, transportation, preparation, or analysis of samples. To remove non-site related constituents from further consideration, the concentrations of chemicals detected in blanks were compared with concentrations of the same chemicals detected in environmental samples.

Common laboratory contaminants (i.e., acetone, 2-butanone, chloroform, methylene chloride, toluene, and phthalate esters) were retained for use in interpreting site conditions only when observed concentrations in any environmental sample exceeded ten times the maximum concentration detected in any blank. If the concentration of a common laboratory contaminant was less than ten times the maximum blank concentration, its presence among the sample set was attributed to laboratory contamination in that particular sample and excluded from further evaluation (USEPA, 1989). The maximum concentrations of detected common laboratory contaminants in blanks were as follows:

- | | |
|-------------------------------|-----------------------|
| ● Acetone | 24 J $\mu\text{g/L}$ |
| ● Chloroform | 13 $\mu\text{g/L}$ |
| ● 2-Butanone | 32 $\mu\text{g/L}$ |
| ● bis-(2-Ethylhexyl)phthalate | 280 J $\mu\text{g/L}$ |

Blanks containing organic constituents that were not considered common laboratory contaminants (i.e., all other TCL compounds) were retained in the site analytical database only when observed concentrations exceeded five times the maximum concentration detected in any QA/QC blank (USEPA, 1989). All TCL compounds detected at less than five times the maximum level of contamination noted in any QA/QC blank were attributed to blank contamination and excluded from further evaluation. The maximum concentrations of all other detected blank contaminants were as follows:

- | | |
|------------------------|--------------------|
| ● Bromodichloromethane | 13 $\mu\text{g/L}$ |
| ● Dibromochloromethane | 10 $\mu\text{g/L}$ |

A limited number of environmental samples that exhibited high concentrations of tentatively identified compounds (TICs) were subjected to an additional sample preparation. Medium level sample preparation provides a corrected Contract Required Quantitation Limit (CRQL) based on the volume of sample used for analysis. The corrected CRQL produces higher detection limits than the

low level sample preparation. A comparison to laboratory blanks used in the medium level preparation was used to evaluate the relative amount of contamination within these samples.

4.2.2 Naturally-Occurring Inorganic Analytes

In order to differentiate between inorganic contamination due to site operations and naturally-occurring inorganic analytes in site media, the results of the sample analyses were compared to information regarding background conditions at MCB, Camp Lejeune. The following guidelines were used for each media:

Soil:	MCB, Camp Lejeune Background Soil Samples
Groundwater:	MCB, Camp Lejeune Background Groundwater Samples
Surface Water:	MCB, Camp Lejeune Background Surface Water Samples
Sediment:	MCB, Camp Lejeune Background Sediment Samples

The following subsections address the various comparison criteria used to evaluate soil, groundwater, surface water, and sediment analytical results from samples collected at Site 43.

4.2.2.1 Soil

In general, applicable or relevant and appropriate requirements (ARARs) are not available for specific contaminants in soil. As a result, base-specific background concentrations have been compiled from a number of locations throughout MCB, Camp Lejeune to evaluate reference levels of inorganic analytes in the surface and subsurface soil.

Typical background concentration values for inorganic analytes in soils at MCB, Camp Lejeune are presented in Appendix P. These values are based on analytical results of background samples collected in areas not known to have been impacted by operations or disposal activities adjacent to Sites 1, 2, 6, 7, 16, 28, 30, 35, 36, 41, 43, 44, 54, 69, 74, 78, 80, and 86 (refer to Figure 1-2 for site locations throughout MCB, Camp Lejeune). Subsequent discussions of the analytical results from samples collected during the soil investigation only consider those inorganic analytes with concentrations exceeding twice the average base-specific background concentration, as recommended by USEPA Region IV.

In general, background soil samples have been collected outside the known boundaries of those sites listed above in areas with similar soil types. According to the SCS Soil Survey, the greatest portion of MCB, Camp Lejeune is underlain by a number of similar soil units. Soils found on this portion of the coastal plain are moderately to strongly acidic in nature and are classified under the USCS as SM, SM-SP (i.e., fine sand or loamy fine sand). Section 3.0 provides the locations of background soil borings completed at Site 43 during this investigation.

4.2.2.2 Groundwater

Chemical-specific ARARs are available for evaluation of analytical results from groundwater samples. In the subsequent sections which address the analytical results of samples collected during the groundwater investigation, only those inorganic parameters with concentrations exceeding applicable state or federal regulations will be discussed.

Groundwater samples were analyzed for total inorganic parameters. In addition, a limited number of selected groundwater samples were submitted for dissolved (i.e., "filtered") inorganic analyses. Concentrations of dissolved inorganics were found to be generally lower than total inorganic concentrations, particularly for metals such as chromium, iron, lead, and manganese. A 0.45-micron filter was used in the field to remove small particles of silt and clay that would otherwise be dissolved during sample preservation, resulting in higher concentrations of inorganic analytes. The total metal analyses from unfiltered samples is considered to reflect the concentrations of inorganics in the natural lithology and inorganic analytes dissolved in the groundwater.

Higher concentrations of certain metals in unfiltered groundwater samples collected at MCB, Camp Lejeune are not considered atypical based on experience gained during other studies. The difference between the two analytical results (i.e., total and filtered) is important in terms of understanding and separating naturally-occurring elements (e.g., lead) from contamination by site operations (e.g., lead in gasoline). An evaluation report which pertains to naturally occurring metals in groundwater at MCB, Camp Lejeune is provided in Appendix P.

USEPA Region IV requires that unfiltered inorganic concentrations be used in evaluating ARARs and risk to human health and the environment. In the subsequent sections, which discuss the groundwater sample analytical results, both total and dissolved inorganics (which exceed applicable state or federal limits) will be presented and discussed for comparison purposes.

Groundwater in the MCB, Camp Lejeune area is naturally rich in iron and manganese. Iron and manganese concentrations, both for total and filtered samples, in groundwater at MCB, Camp Lejeune often exceed the North Carolina Water Quality Standards (NCWQS) of 300 and 50 µg/L, respectively. Elevated levels of iron and manganese, at concentrations above the NCWQS, were reported in samples collected from a number of base potable water supply wells which are installed at depths greater than 162 feet below ground surface (Greenhorne and O'Mara, 1992). Iron and manganese concentrations from several wells at Site 43 exceeded the NCWQS but fell within the range of concentrations for samples collected elsewhere at MCB, Camp Lejeune. There is no record of any historical use of iron or manganese at Site 43. In light of this, it is assumed that iron and manganese are naturally-occurring inorganic analytes in groundwater, and their presence is not attributable to site operations.

4.2.2.3 Surface Water

In the sections which address the analytical results of samples collected during the surface water investigation, only those inorganic parameters with concentrations exceeding applicable state or federal regulatory limits will be discussed. Base-specific background concentrations have been compiled from a number of locations throughout MCB, Camp Lejeune to supplement the evaluation of detected inorganic analytes in surface water. Typical inorganic background concentration values for surface waters at MCB, Camp Lejeune are presented in Appendix P. These values are based on analytical results of background samples collected upgradient of areas known or suspected to have been impacted by operations or disposal activities. Inorganic parameters detected below these levels are assumed to be naturally-occurring elements.

4.2.2.4 Sediment

Base-specific inorganic background concentrations have been compiled from a number of locations throughout MCB, Camp Lejeune to supplement the evaluation of detected inorganic analytes in

sediment. Those inorganic analytes that exceed applicable state or federal regulatory limits are compared to base-specific background concentrations in subsequent sections. Typical inorganic background concentration values for sediments at MCB, Camp Lejeune are presented in Appendix P. These values are based on analytical results of background samples collected upgradient of areas known or suspected to have been impacted by operations or disposal activities. Inorganic parameters detected below these levels are assumed to be naturally-occurring elements.

4.3 Analytical Results

This section presents the results of the soil, groundwater, surface water, and sediment investigations performed at Site 43. A summary of site contamination, by media, is provided in Table 4-2.

4.3.1 Soil Investigation

Unique sample notations were employed to identify soil sampling locations and sample depths at Site 43. Samples designated by "WA," "MA," "DA," and "OA" were collected from specific portions of the site (as described in Section 3.0). Samples designated with the prefix "GW" were collected from monitoring well pilot test borings. The suffix "DW" after the monitoring well number indicates that the sample was obtained from a deep monitoring well test boring. The following suffix designations refer to the depth at which a sample was obtained:

- 00 - ground surface to 12 inches bgs
- 01 - 1 to 3 feet bgs
- 02 - 3 to 5 feet bgs
- 03 - 5 to 7 feet bgs
- 04 - 7 to 9 feet bgs
- 05 - 9 to 11 feet bgs

Surface soil positive detection summaries for organic compounds and inorganic analytes are presented in Tables 4-3 and 4-4. A positive detection summary of organic compounds in subsurface soil is presented in Table 4-5; a summary of inorganic analytes is provided in Table 4-6. The majority of soil samples collected at Site 43 were analyzed for full TCL organics and TAL inorganics using CLP protocols and Level IV data quality (refer to Section 3.0). Soil samples obtained from monitoring well test borings were also analyzed for full TCL organics and TAL inorganics.

4.3.1.1 Surface Soil

A total of 28 surface soil samples were obtained at Site 43 and submitted for TCL semivolatile analyses. Seven of the 28 surface soil samples were also analyzed for TCL volatiles, pesticides, and PCBs; 21 of the 28 samples were submitted for TAL metal analyses. In addition, 4 of the 28 samples were also submitted to the laboratory for TPH analyses. As indicated in Table 4-2, only semivolatile and pesticide organic compounds were detected in surface soils at Site 43.

Twenty semivolatile compounds were detected among 12 of the 28 surface soil samples that were submitted for laboratory analyses. The vast majority of positive SVOC detections were within soil samples obtained from a cleared portion of the study area, located along the main loop access road. Fourteen of the 20 semivolatile contaminants detected were polynuclear aromatic hydrocarbons (PAHs). As presented in Table 4-2, semivolatile concentrations ranged from 35 µg/kg of

dibenzofuran to 64,000 µg/kg of pyrene. Seventeen of the 20 SVOCs were detected at their respective maximum concentrations within a surface soil sample obtained from location WA-SB01A. The following PAH compounds were detected with the most frequency, each identified at least eight times among surface soil samples: phenanthrene, fluoranthene, pyrene, benzo(a)anthracene, chrysene, benzo(b)fluoranthene, benzo(a)pyrene, ideno(1,2,3-cd)pyrene, dibenzo(a,h)anthracene, and benzo(g,h,i)perylene.

Pesticide compounds were detected in five of the seven surface soil samples submitted for laboratory analyses from Site 43. The pesticides 4,4'-DDE and 4,4'-DDT were detected in five and four of the seven samples, respectively. Heptachlor epoxide, 4,4'-DDD, and endrin aldehyde were detected only once among the sample set. As indicated in Table 4-2, the compounds 4,4'-DDE, 4,4'-DDT, and 4,4'-DDD were detected at their maximum concentrations in a sample obtained from location DA1-SB03. Pesticide concentrations ranged from 2 µg/kg of heptachlor epoxide to 3,000 µg/kg of 4,4'-DDD.

Nineteen of 23 TAL metals were detected among the 21 surface soil samples obtained from Site 43 (antimony, beryllium, silver, and thallium were not detected). Table 4-2 provides a summary of the priority pollutant metals found within soil samples at Site 43. Priority pollutant metals are a subset of TAL metals that include antimony, arsenic, beryllium, cadmium, chromium, copper, lead, mercury, nickel, selenium, silver, thallium, and zinc. As provided in Table 4-2, cadmium, chromium, copper, lead, manganese, mercury, nickel, and zinc were each detected at concentrations exceeding twice their average base-specific (i.e., MCB, Camp Lejeune) background levels (refer to Appendix P for base-specific inorganic background concentrations). at least twice among surface soil samples. Chromium, lead, manganese, and zinc were detected at concentrations greater than one order of magnitude above twice their average base-specific background level in samples obtained from buried container areas.

4.3.1.2 Subsurface Soil

A total of 20 subsurface (i.e., greater than one-foot below ground surface) soil samples were obtained at Site 43 and submitted for TCL semivolatile and TAL metal analyses. Seven of the 20 subsurface soil samples were also analyzed for TCL volatiles, pesticides, and PCBs. As indicated in Table 4-2, no volatile or PCB organic compounds were detected among the 20 samples obtained from Site 43.

Semivolatile organic compounds were detected in only 2 of the 20 subsurface soil samples obtained from Site 43 (refer to Table 4-2). A total of 12 semivolatile contaminants were detected in a subsurface sample obtained from location WA-SB02; 10 of the 12 semivolatile contaminants were PAH compounds. A single butylbenzylphthalate detection of 440 µg/kg in a sample obtained from location OA-SB03 was the only other SVOC observed among Site 43 subsurface soil samples. As provided in Table 4-2, the maximum SVOC concentration was that of pyrene at 1,800 µg/kg in a sample obtained from location WA-SB02.

Three pesticide compounds were detected among the seven subsurface soil samples obtained from Site 43. Only one of the seven subsurface samples submitted for laboratory analysis had detectable concentrations of pesticides. As presented in Table 4-2, the pesticides 4,4'-DDE, 4,4'-DDD, and 4,4'-DDT were detected in the sample obtained from location DA1-SB03 at concentrations of 9, 1,200, and 45 µg/kg, respectively. No other pesticides were detected in any of the other six subsurface soil samples.

Seventeen of 23 TAL inorganics were detected in subsurface soils at Site 43 (antimony, beryllium, cadmium, mercury, silver, and thallium were not detected). As presented in Table 4-2, copper was the only priority pollutant metal detected at a concentration which slightly exceeded twice its average base background level (refer to Appendix P for base-specific inorganic background concentrations). Copper was detected in 6 of the 20 subsurface samples. The maximum copper concentration was 3.6 µg/kg in sample OA-SB01 which exceeded twice the average base-specific background concentration of 2.4 µg/kg.

4.3.1.3 Summary

Positive detections of SVOCs in soil samples obtained at Site 43 are primarily limited to a cleared portion of the study area adjacent to the gravel access road. A total of 20 semivolatile contaminants, including 14 PAH compounds, were identified during the soil investigation at Site 43. The 14 PAH compounds were identified in both surface and subsurface soil samples. As provided in Table 4-2, a majority of maximum semivolatile detections were observed in surface samples obtained from the first 12 inches below ground surface.

Based upon the results of analyses from seven surface and seven subsurface soil samples, the pesticides 4,4'-DDE and 4,4'-DDT appear to be scattered throughout the study area. The pesticide 4,4'-DDE was the most prevalent, with six positive detections ranging from 5.7 to 1,000 µg/kg. The highest pesticide concentration was that of 4,4'-DDD at 3,000 µg/kg. In general, higher concentrations of pesticides were observed in samples obtained from a small portion of the study area with partially buried containers.

Inorganic analytes were detected in both surface and subsurface soil samples throughout the study area. Chromium, lead, manganese, and zinc were each detected above twice their average base-specific background levels in more than 5 of the 20 surface soil samples. In general, higher concentrations of inorganic analytes were detected in soil samples obtained from two separate portions of the study area with partially metal buried containers.

4.3.2 Groundwater Investigation

The investigation at Site 43 entailed the collection of groundwater samples from three existing shallow wells (43-GW01, 43-GW02, and 43-GW03), one newly installed shallow well (43-GW04), four temporary wells (43-TW01 through 43-TW04), and two newly installed deep wells (43-GW01DW and 43-GW04DW). Each of the groundwater samples collected at Site 43 was analyzed for full TCL organics and TAL total metals using CLP protocols and Level IV data quality. In addition, one of the groundwater samples was submitted for dissolved TAL metal analyses. (Dissolved or filtered TAL inorganic results are presented in this report for comparative purposes only. These results were not used to evaluate site-related risks or to determine compliance with groundwater standards.)

Analytical results from the groundwater investigation at Site 43 are provided in the subsections which follow. A positive detection summary of organic compounds is provided in Table 4-7. Total and dissolved metal results are presented in Tables 4-8 and 4-9.

4.3.2.1 Shallow Groundwater

Groundwater conditions within the upper portion of the surficial aquifer were evaluated through collection and analysis of samples from existing, newly-installed, and temporary monitoring wells at Site 43 (refer to Section 3.0 and Appendix B for well construction details). A total of eight shallow groundwater samples from Site 43 were submitted for laboratory analyses. As indicated in Table 4-2, no VOCs were detected among the eight groundwater samples collected from the shallow aquifer; nor were pesticides and PCBs detected.

The only SVOC detected among shallow groundwater samples submitted for laboratory analyses from Site 43 was 4-methylphenol. The groundwater sample obtained from temporary monitoring well 43-TW04 had a 4-methylphenol concentration of 2 µg/L. Temporary monitoring well 43-TW04 is located near the confluence of Edwards and Strawhorn Creeks, in the northern-most portion of Site 43. No other organic contaminants were detected among groundwater samples obtained from Site 43.

TAL total metals were detected in each of the temporary and shallow monitoring wells at Site 43. None of the samples obtained from the shallow aquifer were submitted for dissolved metal analyses. A complete positive detection summary for total metals in groundwater is provided in Table 4-8. Fourteen of the 23 TAL total metals were detected within at least one groundwater sample at Site 43 (antimony, arsenic, beryllium, cadmium, chromium, cobalt, mercury, selenium, silver, and thallium were not detected among shallow groundwater samples). As provided in Table 4-2, iron and manganese were detected with the greatest frequency among groundwater samples and at concentrations in excess of NCWQS levels. Iron exceeded the NCWQS of 300 µg/L in six of the eight shallow groundwater samples, with a maximum concentration of 33,800 µg/L. Manganese was detected at concentrations exceeding the NCWQS of 50 µg/L in only one of the eight shallow groundwater samples, at a concentration of 107 µg/L. Both the maximum iron and manganese concentrations were detected in a sample obtained from temporary monitoring well 43-TW04.

4.3.2.2 Deep Groundwater

Two groundwater samples were obtained from the deep aquifer at Site 43; one from an upgradient location and the other from the central portion of the study area. Deep monitoring wells were screened at intervals just below a semi-confining unit, into the upper portion of the Castle Hayne aquifer. Volatile, semivolatile, pesticide, and PCB organic compounds were not detected in either of the samples obtained from the deep aquifer.

TAL total metals were detected in both of the deep monitoring wells at Site 43. Dissolved metals were also detected in the one deep groundwater sample submitted for filtered analysis. Complete positive detection summaries for total and dissolved metals are provided in Tables 4-8 and 4-9. Only 8 of 23 TAL total metals were detected in the two deep groundwater samples obtained from monitoring wells 43-GW01DW and 43-GW04DW. Manganese was detected in well 43-GW01DW at a concentration of 86.7 µg/L that exceeded the NCWQS of 50 µg/L. Iron was detected in one deep groundwater samples obtained from Site 43 at concentrations of 649 and 997 µg/L, which exceeded the North Carolina screening standard of 300 µg/L. None of the other TAL total metals that were detected in the deep aquifer exceeded MCL or NCWQS levels.

4.3.2.3 Summary

Total metals were the most prevalent and widely distributed constituents in groundwater at Site 43. Concentrations of TAL total metals were generally higher in groundwater samples obtained from the shallow aquifer, rather than in samples obtained from the deeper aquifer. Iron and manganese were the most prevalent inorganic analytes, detected at concentrations that exceeded state standards. Table 4-2 presents a summary of inorganic analytes in excess of applicable state standards.

A single positive detection of one organic compound, 4-methylphenol, was limited to a temporary monitoring well located in the northern portion of the study area. No other organic compounds were detected among groundwater samples obtained from the shallow and deep aquifers.

4.3.3 **Surface Water Investigation**

Environmental samples were collected from Edwards Creek and Strawhorn Creek, a tributary to Edwards Creek, as part of the surface water investigation at Site 43. A total of six surface water samples were collected at Site 43 during the field investigation. Four of the sampling stations were located in Strawhorn Creek and two were located in Edwards Creek. Each of the six surface water samples were analyzed for full TCL organics and TAL inorganics (both total and dissolved fractions), using CLP protocols and Level IV data quality.

Analytical results from the surface water investigation at Site 43 are provided in the subsections which follow. Table 4-2 provides a summary of results of surface water contamination. A positive detection summary of organic compounds found in surface water samples at Site 43 is provided in Table 4-10. Total and dissolved metal results from both surface water bodies at Site 43 are presented in Tables 4-11 and 4-12. National Oceanic and Atmospheric Administration (NOAA) screening values and North Carolina WQS (15A NCAC 2b) were employed during the evaluation of surface water analytical results. Semivolatile and PCB organic compounds were not detected in any of the six surface water samples submitted for those analyses and, therefore, will not be considered further. Volatile organic compounds were not detected in any of the surface water samples obtained from Strawhorn Creek and, correspondingly, will not be addressed.

4.3.3.1 Edwards Creek

A positive detection of one volatile organic compound was observed among the two surface water samples obtained from Edwards Creek. The VOC 1,2-dichloroethene was detected at a concentration of 2 µg/L in samples EC-SW01 and EC-SW02, located along the northern-most portion of the study area.

The pesticides 4,4'-DDE and 4,4'-DDD were detected at trace concentrations of 0.097 and 0.64 µg/L in sample EC-SW01. Applicable screening values for 4,4'-DDE and 4,4'-DDD are 0.00059 and 0.00084 µg/L. As provided in Table 4-2, both detections represent an exceedence of the applicable screening values. No other pesticide compounds were detected among the two surface water samples obtained from Edwards Creek.

As presented in Table 4-11, 12 of 23 TAL total metals were positively identified among the surface water samples obtained from Edwards Creek (antimony, beryllium, cadmium, chromium, cobalt, mercury, nickel, selenium, silver, thallium, and zinc were not detected). Positive detections of metals were compared to screening values for surface water bodies classified as saltwater

(i.e., containing greater than five percent saltwater). Copper was the only TAL total metal detected among surface water samples at a concentration which exceeded an applicable screening value. Copper was detected at a concentration of 3.2 µg/L in the surface water sample obtained from station EC-SW02. The NCWQS for copper in tidally influenced surface water bodies is 3 µg/L. Although the positive copper detection slightly exceeded the screening value, it did not exceed the range of base-specific background concentrations (refer to Appendix P). No other total metal concentrations among surface water samples exceeded state or federal screening values.

4.3.3.2 Strawhorn Creek

Positive detections of two pesticide compounds were observed among the four surface water samples obtained from Strawhorn Creek. The pesticide 4,4'-DDD was detected in samples obtained from stations SHC-SW03 and SHC-SW04 at concentrations of 0.23 and 0.12 µg/L, respectively. Both 4,4'-DDD detections exceeded the 0.00084 µg/L screening value. At sampling location SHC-SW04, 4,4'-DDE was detected at a concentration of 0.095 µg/L. Both detections of 4,4'-DDD exceeded the applicable screening value of 0.00059 µg/L. The two sampling locations are situated approximately 350 and 700 feet upstream of the Edwards Creek and Strawhorn Creek confluence. No other pesticides were detected among surface water samples submitted for laboratory analysis from Site 43.

Laboratory analyses of four surface water samples obtained from Strawhorn Creek indicate that 12 of 23 possible total metals were positively detected. As indicated in Table 4-2, none of the total metal concentrations in the four surface water samples obtained from Strawhorn Creek exceeded state or federal screening values.

4.3.4 **Sediment Investigation**

Environmental samples were collected from Edwards Creek and Strawhorn Creek as part of the sediment investigation at Site 43. A total of 12 sediment samples were collected during the investigation; 2 samples were collected from each of the 6 sampling stations. Sediment samples were obtained from zero to six inches and also from six to twelve inches into the sediment. Four of the 12 samples were obtained from Edwards Creek and the remaining 8 samples were obtained from Strawhorn Creek. Each of the 12 sediment samples were analyzed for full TCL organics and TAL inorganics, using CLP protocols and Level IV data quality. In addition, each of the sediment samples were submitted for grain size and total organic carbon analyses.

Analytical results from the sediment investigation at Site 43 are provided in the subsections which follow. Table 4-2 provides a summary of sediment contamination. Positive detection summaries of organic compounds found in Edwards Creek and Strawhorn Creek are provided in Table 4-13. Total metal results from sediment samples obtained as part of the Site 43 investigation are presented in Table 4-14. PCB compounds were not detected in any of 12 sediment samples and therefore will not be addressed.

4.3.4.1 Edwards Creek

Carbon disulfide was the only VOC detected among the four sediment samples obtained from Edwards Creek. As provided in Table 4-13, carbon disulfide was identified at concentrations of 20 and 26 µg/kg in a samples obtained from stations EC-SD01 and EC-SD02. No other VOC was detected among sediment samples from Edwards Creek.

One SVOC was detected in three of the four sediment samples obtained from Edwards Creek. As provided in Table 4-13, benzo(a)pyrene was detected in two of the four sediment samples at concentrations of 650 and 1,400 µg/kg. The two benzo(a)pyrene detections, observed at both Edwards Creek sampling stations, exceeded the NOAA Effects Range-Low (ER-L) screening value of 400 µg/kg. Pyrene was detected in one of the four sediment samples at a concentration of 200 µg/kg, which did not exceed the 350 µg/kg screening value. Both benzo(a)pyrene and pyrene are PAH compounds. No other SVOCs were detected in the sediment samples obtained from Edwards Creek.

The pesticide 4,4'-DDD was detected in each of the four sediment samples obtained from Edwards Creek. As indicated in Table 4-13, the pesticides 4,4'-DDE, endrin, 4,4'-DDT, alpha-chlordane, and gamma-chlordane were also detected at least once among the four sediment samples. The maximum pesticide concentration, 4,4'-DDD at 8,500 µg/kg, was detected at sampling station EC-SD01. As indicated in Table 4-2, each positive detection for five of the six identified pesticides exceeded applicable screening values; there are no screening values for endrin. The pesticides 4,4'-DDE, endrin, 4,4'-DDT, alpha-chlordane, and gamma-chlordane were detected at maximum concentrations of 1,600, 16, 180, 21, and 31 µg/kg, respectively. No other pesticide compounds were detected among sediment samples obtained from Edwards Creek.

Twenty of 23 TAL total metals were positively identified among the four Edwards Creek sediment samples (antimony, beryllium, and thallium were not detected). Lead, mercury, silver, and zinc were identified at concentrations in excess of their respective NOAA ER-L screening values. As provided in Table 4-14, lead, mercury, and zinc were each detected in excess of sediment screening values within two of the four samples obtained from Edwards Creek. Silver was detected once among the four samples at a concentration of 2.8 µg/kg, which exceeded the 1.0 µg/kg screening value. Lead, mercury, and zinc were each detected at their respective maximum concentrations among the four Edwards Creek sediment samples at station EC-SD01. Lead and zinc were detected at maximum concentrations of 180 and 338 µg/kg. The NOAA ER-L screening values for lead and zinc are 35 and 120 µg/kg, respectively. However, none of the lead, silver, or zinc concentrations exceeded base-specific background metal concentrations (refer to Appendix P). Concentrations of mercury in samples EC-SD01 (0.66 µg/kg) and EC-SD02 (0.44 µg/kg) slightly exceeded the screening value of 0.15 µg/kg. No other total metal concentrations among the four Edwards Creek sediment samples exceeded applicable screening values.

4.3.4.2 Strawhorn Creek

Carbon disulfide was the only volatile organic compound detected among the eight sediment samples obtained from Strawhorn Creek. As provided in Table 4-13, carbon disulfide was detected at a concentration of 3 µg/kg in a sample obtained from station SHC-SD01. Sampling station SHC-SD01 is located slightly upgradient of the suspected disposal area at Site 43.

Two semivolatile compounds were identified in sediment samples obtained from Strawhorn Creek. As provided in Table 4-13, 4-methylphenol and benzo(a)pyrene were positively identified in one and two of the eight sediment samples, respectively. No semivolatile compounds were detected at location SHC-SD01, located slightly upstream of the suspected disposal area. The maximum semivolatile concentration among sediment samples obtained from the Strawhorn Creek was that of benzo(a)pyrene at 1,900 µg/kg. As presented in Table 4-2, this benzo(a)pyrene detection from sampling station SHC-SD02 exceeded the NOAA ER-L screening value of 400 µg/kg. The SVOC

4-methylphenol was detected at a maximum concentration of 210 µg/kg in sample SHC-SD03. No other SVOCs were detected among sediment samples obtained from Strawhorn Creek.

The pesticides 4,4'-DDE, endrin, 4,4'-DDD, 4,4'-DDT, alpha-chlordane, and gamma-chlordane were detected among the eight sediment samples obtained from Strawhorn Creek. As provided in Table 4-13, 4,4'-DDE and 4,4'-DDD were detected most frequently among organic compounds in sediment. Both 4,4'-DDE and 4,4'-DDD were detected in seven of the eight samples, at maximum concentrations of 8,900 and 37,000 µg/kg in a sample obtained from station SHC-SD04. The pesticide 4,4'-DDT was detected in four of the eight samples with a maximum concentration of 65 µg/kg also in sample SHC-SD04. Alpha-chlordane and gamma-chlordane were detected in six of the eight samples at maximum concentrations of 49 and 74 µg/kg. Endrin was detected once among Strawhorn Creek sediment samples at a concentration of 12 µg/kg. Excluding endrin, each pesticide detection in sediment samples obtained from Strawhorn Creek exceeded applicable NOAA ER-L screening values.

Nineteen of 23 TAL total metals were positively identified among the 8 sediment samples obtained from Strawhorn Creek (antimony, cadmium, mercury, and thallium were not detected). Of the nineteen inorganics detected, lead, silver, and zinc were identified at concentrations in excess of applicable NOAA ER-L screening values. As provided in Table 4-14, lead was detected in five of the six sediment samples obtained from Strawhorn Creek at concentrations in excess of the 35 µg/kg screening value. The maximum lead concentration, 206 µg/kg, was detected at sampling location SHC-SD03. Silver and zinc were detected in excess of sediment screening values in one and two of the eight Strawhorn Creek sediment samples, respectively. The silver concentration of 1.9 µg/kg in sample SHC-SD03 exceeded the NOAA screening value of 1.0 µg/kg. Zinc was detected twice at concentrations of 223 and 254 µg/kg which exceeded the 120 µg/kg screening value. No other total metal concentrations among the eight Strawhorn Creek sediment samples exceeded screening values. As provided in Table 4-2, lead, silver, and zinc were detected at concentrations within base-specific background levels.

4.4 Extent of Contamination

This section addresses the extent of contamination within soil, groundwater, surface water, and sediment at Site 43.

4.4.1 Extent of Soil Contamination

Positive detections of organic compounds in both surface and subsurface soil samples at Site 43 are depicted on Figures 4-1 and 4-2. The following subsections detail the presence of both organic compounds and inorganic analytes in soil samples at Site 43. As addressed in Section 4.3.1, volatile and PCB organic contaminants were not detected in any of the soil samples submitted for analyses. As a result of those analyses, the extent of volatile and PCB contamination in soil will not be addressed.

4.4.1.1 Semivolatiles

The presence and dispersion of SVOCs in soil, particularly PAH compounds, are most likely the result of former disposal operations at Site 43. Concentrations of PAH compounds in soil samples are consistent with the historical use of Site 43 as a dump and indicative of refuse disposal or open burning. Semivolatile compounds were identified in both surface and subsurface soil samples

obtained from the cleared portion of the study area, adjacent to the gravel access road. As depicted on Figures 4-1 and 4-2, concentrations of SVOCs were more prevalent and detected at higher concentrations in surface samples, compared to SVOC concentrations in subsurface samples. In general, soil analytical results correspond directly to the visual identification of fill or graded material (including possible spiractor grit material) observed during the field investigation (see Appendices A, B, and C for soil descriptions).

4.4.1.2 Pesticides

Positive detections of pesticides were observed in both surface and subsurface soil samples at Site 43. As Figures 4-1 and 4-2 depict, pesticide concentrations were generally low and most likely the result of the routine base-wide application and use of pesticides. However, both surface and subsurface samples obtained from location DA1-SB03 had elevated pesticide detections compared to other samples submitted from Site 43. This area was identified during the RI scoping site visit as having several partially buried metal containers. Another similar area was identified during the RI at Site 43. The presence of these containers may help to explain the elevated pesticide detections. In addition, much of the study area appears to have been graded during previous site operations (refer to Section 2.0); the reworked soil may have also contained residual concentrations of pesticides. The frequency and overall concentration of pesticides in soil, nonetheless, does not suggest pesticide disposal activities.

4.4.1.3 Metals

As addressed in Section 4.3.1 and depicted in Tables 4-4 and 4-6, only 3 of the 41 samples submitted for analysis had TAL metal concentrations greater than one order of magnitude above base-specific background levels. The metals chromium, lead, manganese, and zinc were detected at concentrations greater than one order of magnitude above twice the average base-specific background levels in samples obtained from locations with partially buried containers. Findings from the analytical program are consistent with visual observations of buried metallic objects and graded surface material recorded during the field investigation (see Appendices A, B, and C). Elevated concentrations of metals are most probably the result of buried material, in the presence of naturally-occurring acidic soils.

4.4.2 **Extent of Groundwater Contamination**

Positive detections of organic compounds in groundwater samples collected at Site 43 are depicted on Figure 4-3. Figure 4-4 presents groundwater sampling results of TAL metals detected at concentrations in excess of either Federal MCL or North Carolina WQS standards. As addressed in Section 4.3.2, volatile, pesticide, and PCB organic contaminants were not detected in any of the shallow or deep aquifer samples submitted for analyses from Site 43. As a result of those analyses, the extent of volatiles, pesticides, and PCBs in groundwater will not be addressed.

4.4.2.1 Semivolatiles

Semivolatile organic compounds were detected in only one of the ten groundwater samples obtained from Site 43. No SVOCs were detected in the two samples obtained from the deep aquifer (i.e., the Castle Hayne aquifer), which suggests that constituents of concern have not migrated to depths greater than 70 feet below ground surface.

The SVOC 4-methylphenol was detected at a concentration of 2 µg/L in a sample obtained from temporary monitoring well 43-TW04, located in the northern portion of Site 43 near the confluence of Edwards and Strawhorn Creeks (see Figure 4-3). No other organic compounds were detected among groundwater samples at Site 43. The proximity of temporary monitoring well 43-TW04 relative to both Edwards and Strawhorn Creeks, may provide a possible explanation for the presence of 4-methylphenol at this location. Temporary monitoring well 43-TW04 is situated in a low-lying portion of the study area which is subject to seasonal flooding. Both volatile and semivolatile organic compounds were detected in surface water and sediment media at Site 43. During periods of high precipitation or seasonal fluctuations of the water table, observed organic compounds are likely to have migrated from nearby creeks onto the land surface and eventually into the groundwater at this location. The low concentration of 4-methylphenol in 43-TW04 coupled with higher detections of the same compound in nearby soil and sediment media suggests that migration has occurred.

4.4.2.2 Metals

Inorganic analytes were detected in each of the ten groundwater samples submitted for analysis from Site 43. Iron and manganese were the only TAL total metals detected at levels in excess of either Federal MCL or North Carolina WQS (see Figure 4-4). Positive detections of both iron and manganese were distributed throughout the site, indicative of natural site conditions rather than disposal activities. Generally, concentrations of TAL metals in groundwater at Site 43 were higher in samples obtained from the shallow aquifer. Concentrations of both iron and manganese were particularly higher in a sample obtained from the northern portion of the study area. Temporary monitoring well 43-TW04 was installed in very loose material adjacent to the confluence of Edwards and Strawhorn Creeks. The likely presence of colloids and suspended material in the groundwater sample contributed to the higher TAL total metal concentrations.

Elevated total metal observations have been recorded at other MCB, Camp Lejeune sites and have been attributed as the likely consequence of loose surficial soils. During sampling, a low flow purge method was utilized to minimize the presence suspended solids or colloids in samples that are associated with the surficial soils. The DON is currently evaluating the presence and distribution of total and dissolved metals in groundwater throughout the facility. The draft report entitled "Evaluation of Metals in Groundwater at MCB, Camp Lejeune, North Carolina," (provided in Appendix P) addresses the pervasiveness of total metals in groundwater and identifies a number of potential causes. Preliminary conclusions of the study support the opinion that certain total metal concentrations in groundwater are due more to geologic conditions (i.e., naturally occurring concentrations and unconsolidated soils) and sample acquisition methods than to mobile metal concentrations in the surficial aquifer.

4.4.3 **Extent of Surface Water Contamination**

Positive detections of organic compounds in surface water samples collected at Site 43 are depicted on Figure 4-5. Figure 4-6 presents TAL metal sampling results in excess of either state or federal surface water screening values. A summary of site contamination is presented in Table 4-2. As addressed in Section 4.3.3, semivolatile and PCB contaminants were not detected in any of the surface water samples submitted for analyses from Site 43. As a result of those analyses, the extent of semivolatile and PCB compounds in surface water will not be addressed. Volatile organic compounds were not detected among surface water samples obtained from Strawhorn Creek, correspondingly, the extent of volatile compounds in Strawhorn Creek will not be addressed.

4.4.3.1 Volatiles

Edwards Creek

A single volatile organic compound, 1,2-dichloroethene, was detected at a concentration of 2 µg/L in both samples obtained from Edwards Creek. The same compound was identified during investigation activities at Site 44, among upstream surface water samples obtained from Edwards Creek. Based upon a lack of positive detections in other environmental media at Site 43 and evidence of similar upstream VOC contamination, the presence of 1,2-dichloroethene in surface water is most probably the result of migration via Edwards Creek from an off-site source.

4.4.3.2 Pesticides

Edwards Creek

The pesticides 4,4'-DDE and 4,4'-DDD were detected in one of the two surface water samples obtained from Edwards Creek at concentrations of 0.097 and 0.64 µg/L. The detections represent exceedences of applicable screening values, 0.00059 and 0.00084 µg/L for 4,4'-DDE and 4,4'-DDD respectively. The two pesticides were also identified in a sediment sample obtained from the same sampling station. However, pesticide concentrations at this location are not indicative of disposal operations, rather, are more likely the result of former base-wide application and use of pesticides.

Strawhorn Creek

Two pesticide compounds were observed among the four surface water samples obtained from Strawhorn Creek. As depicted on Figure 4-5, the pesticide 4,4'-DDD was detected in samples obtained from two downstream stations at concentrations of 0.23 and 0.12 µg/L. The pesticide 4,4'-DDE was also detected at a concentration of 0.095 µg/L in one of the same samples. Detections of both 4,4'-DDE and 4,4'-DDD exceeded their respective screening values of 0.00059 and 0.00084 µg/L. No other pesticides were detected among surface water samples submitted for laboratory analyses from Site 43. However, the same compounds were prevalent among sediment samples obtained from Strawhorn Creek. The limited number of positive detections and low concentrations of pesticides in Strawhorn Creek surface water samples is not characteristic of pesticide disposal activities. The prevalence and low concentration of pesticides in other sampling media at Site 43 suggests that their occurrence is likely the result of former base-wide application and use of these compounds.

4.4.3.3 Metals

Edwards Creek

Copper was the only TAL total metal identified among the two samples obtained from the Edwards Creek that exceeded state or federal screening values. As depicted on Figure 4-6, only one of the Edwards Creek sampling stations had a positive detection of copper above the 3 µg/L screening value. At location EC-SW02 copper was detected at a concentration of 3.2 µg/L. The limited dispersion and low concentration of positive metal detections in surface water which exceeded applicable screening values is not indicative of former or ongoing disposal activities.

Strawhorn Creek

As depicted on Figure 4-6, none of the TAL total metals identified in the four surface water samples obtained from Strawhorn Creek were detected at concentrations in excess of applicable screening values. Positive detections of metals in samples obtained from the two downstream stations were compared to standards for surface water bodies classified as saltwater (i.e., containing greater than five percent saltwater); results from samples obtained from the two upstream stations were compared to fresh water screening values.

4.4.4 Extent of Sediment Contamination

Positive detections of organic compounds in sediment samples collected at Site 43 are depicted on Figure 4-7. Figure 4-8 presents TAL metal sampling results in excess of NOAA ER-L sediment screening values. A summary of site contamination is presented in Table 4-2. As addressed in Section 4.3.4, PCB contaminants were not detected in any of the 12 sediment samples submitted for analyses from Site 43. As a result of those analyses, the extent of PCB compounds in sediment will not be addressed.

4.4.4.1 Volatiles

Edwards Creek

One VOC was detected among the four Edwards Creek sediment samples. Carbon disulfide was detected at both Edwards Creek sampling stations at concentrations of 20 and 26 $\mu\text{g}/\text{kg}$. The low concentration and the lack of additional detections in other media at Site 43 suggests that carbon disulfide migrated from an off-site source via Edwards Creek.

Strawhorn Creek

Carbon disulfide was also detected at the trace concentration of 3 $\mu\text{g}/\text{kg}$ in one of the Strawhorn Creek sediment samples. The sample obtained from station SHC-SD01, located slightly upgradient of the suspected disposal area, had the only one positive VOC detection. A total of eight Strawhorn Creek sediment samples were submitted for laboratory analyses. No other VOCs were detected in the other seven sediment samples or in samples of other media collected in this portion of the study area. Therefore, it is assumed that the presence of carbon disulfide is limited to that location.

4.4.4.2 Semivolatiles

Edwards Creek

Two semivolatile compounds were detected among the four sediment samples obtained from Edwards Creek. As depicted on Figure 4-7, benzo(a)pyrene was detected twice and pyrene was detected once among Edwards Creek samples; each positive SVOC detection was observed in a separate sample. Benzo(a)pyrene was detected at concentrations of 650 and 1,400 $\mu\text{g}/\text{kg}$ in samples obtained from both Edwards Creek sampling stations. Pyrene was detected only once among the four Edwards Creek samples at a concentration of 200 $\mu\text{g}/\text{kg}$. Several SVOCs were detected at slightly higher concentrations in sediment samples obtained from upgradient sampling stations associated with the RI at Site 44. Given the low concentration of semivolatile compounds among

sediment samples and the presence of similar contaminants in samples obtained from upgradient locations, it is likely that contaminants have migrated from one or more off-site sources.

Strawhorn Creek

Two semivolatile compounds were detected among three of the eight sediment samples obtained from Strawhorn Creek. As Figure 4-7 depicts, positive SVOC detections were observed at three separate sampling stations. Benzo(a)pyrene was detected twice at concentrations of 290 and 1,900 $\mu\text{g}/\text{kg}$ in samples obtained from stations SHC-SD02 and SHC-SD04. The SVOC 4-methylphenol was also detected among the eight Strawhorn Creek samples at a concentration of 210 $\mu\text{g}/\text{kg}$. Strawhorn Creek receives surface water runoff from Agan Street and serves as a drainage basin for residential areas within MCAS, New River. Given the low concentration of semivolatile compounds among sediment samples and the amount of surface water runoff Strawhorn Creek receives, it is likely that contaminants have migrated from various off-site sources such as roadways and residential areas.

4.4.4.3 Pesticides

Edwards Creek

The pesticides 4,4'-DDE, endrin, 4,4'-DDD, 4,4'-DDT, alpha-chlordane, and gamma-chlordane were detected in sediment samples retained for analysis from Edwards Creek. As depicted on Figure 4-7, both 4,4'-DDE and 4,4'-DDD were detected at concentrations greater than 800 $\mu\text{g}/\text{kg}$. The maximum pesticide concentration among Edwards Creek sediment samples was 8,500 $\mu\text{g}/\text{kg}$ of 4,4'-DDD. Excluding endrin, each pesticide concentrations detected among the four Edwards Creek samples exceeded applicable NOAA ER-L screening values. Concentrations of the detected pesticide compounds were typical of levels observed in sediments throughout MCB, Camp Lejeune. Positive detections of these compounds at this location are most likely the result of former base-wide application and use of pesticides.

Strawhorn Creek

The same pesticide compounds detected in Edwards Creek were also detected in sediment samples obtained for laboratory analyses from Strawhorn Creek. Excluding endrin, each pesticide concentration detected among the four Strawhorn Creek samples exceeded applicable NOAA ER-L screening values. As depicted on Figure 4-7, the maximum concentrations of 4,4'-DDE (8,900 $\mu\text{g}/\text{kg}$) and 4,4'-DDD (37,000 $\mu\text{g}/\text{kg}$) were detected in a sample obtained near the confluence of Edwards and Strawhorn Creeks, a portion of Strawhorn Creek with lesser hydraulic gradient. Suspended material from the entire Strawhorn Creek drainage most likely dropped out of suspension at this location. Suspended matter, resulting from surface water runoff over a much larger area, may have effectively washed the pesticide-laden material into Strawhorn Creek. Because pesticides adhere to colloids or suspended soil material, those compounds most probably have been concentrated at this location. The resulting analyses may be more reflective of the base-wide application and use of pesticides rather than indicative of on-site disposal activities. Positive detections of pesticides observed among other media collected during the field investigation were, for the most part, typical of concentrations observed throughout MCB, Camp Lejeune. In addition, the frequency and concentrations of pesticide detections among all the sediment samples is not indicative of disposal activities.

4.4.4.4 Metals

Edwards Creek

Lead, mercury, silver, and zinc were each identified at concentrations in excess of NOAA ER-L screening values. As depicted on Figure 4-8, lead, mercury, and zinc were detected at concentrations in excess of applicable screening values in two of the four samples obtained from Edwards Creek. However, these lead, mercury, and zinc detections did not exceed applicable base-specific background concentrations; there is no base-specific background concentration for mercury (refer to Appendix P). Although positive metal detections in sediment samples obtained from Edwards Creek exceeded applicable screening values, their concentrations are not indicative of metal disposal activities. As mentioned, Edwards Creek serves as a primary drainage for much of MCAS, New River and Camp Geiger, which may account for the limited occurrence of mercury in two of the four sediment samples.

Strawhorn Creek

Lead, silver, and zinc were each identified at concentrations in excess of NOAA ER-L screening values in samples obtained from Strawhorn Creek. As depicted on Figure 4-8, lead was detected in excess of sediment screening values within five of the eight samples obtained from Strawhorn Creek. Silver and zinc were detected at concentrations which exceeded the appropriate screening values in one and two sediment samples, respectively. The NOAA ER-L screening values for lead, silver, and zinc are 35, 1.0, and 120 $\mu\text{g}/\text{kg}$. None of the positive metal detections exceeded base-specific metal concentrations.

4.5 References

Baker Environmental, Inc. December 1994. Remedial Investigation/Feasibility Study Work Plan for Operable Unit No. 6 (Sites 36, 43, 44, 54, and 86), Marine Corps Base Camp Lejeune, North Carolina. Final. Prepared for the Department of the Navy, Naval Facilities Engineering Command, Atlantic Division, Norfolk, Virginia.

Greenhorne & O'Mara, Inc. 1992. Wellhead Monitoring Study Marine Corps Base, Camp Lejeune, North Carolina. Preliminary Draft. Prepared for Department of the Navy, Naval Facilities Engineering Command, Atlantic Division, Norfolk, Virginia.

United States Environmental Protection Agency (USEPA). 1988. Laboratory Guidelines for Evaluating Inorganics Analysis. Prepared for: Hazardous Site Evaluation Division, U.S. Environmental Protection Agency. Compiled by: Ruth Bleyler. Prepared by: The USEPA Data Review Work Group.

USEPA. 1989. United States Environmental Protection Agency. Risk Assessment Guidance for Superfund Volume II. Environmental Evaluation Manual Interim Final. Office of Solid Waste and Emergency Response. Washington, D.C. EPA/540/1-89-001. May 1989.

USEPA. 1991. National Functional Guidelines for Organic Data Review. Draft. USEPA Contract Laboratory Program.

SECTION 4.0 TABLES

TABLE 4-1

SUMMARY OF REJECTED DATA
 SITE 43, AGAN STREET DUMP
 REMEDIAL INVESTIGATION, CTO-0303
 MCAS, NEW RIVER, NORTH CAROLINA

Media	Sample Number	Chemical/Category	Comment
Soil	43-BB-SB02-00	VOCs	1
	43-WA-SB01A-00	SVOCs	2
	43-WA-SB01A3-00	SVOCs	2
	43-WA-SB01A3-00	SVOCs	3
	43-DA2-SB01-00	VOCs	4
	43-OA-SB02-00		
	43-BB-SB03-00	4,4'-DDE 4,4'-DDT	5
	43-BB-SB03-02	4,4'-DDD	5
	43-DA1-SB03-00	4,4'-DDT	5
	43-DA1-SB03-01	4,4'-DDD	5
	43-DA2-SB02-00	SVOCs	6
	43-OA-SB01-01	SVOCs	7
	43-DA2-SB02-00		
	Sediment	43-EC-SD01-612	4,4'-DDD
43-SHC-SD04-612			
43-SHC-SD04-06		4,4'-DDT	6
43-SHC-SD04-06D			
43-EC-SD01-06		4,4'-DDE	6
43-EC-SD01-06D		4,4'-DDD	
43-SHC-SD04-06			
43-SHC-SD04-06D			
43-SHC-SD03-612			
43-SHC-SD03-06			
43-EC-SD02-06			
43-EC-SD01-06			
43-EC-SD01-06D			
43-SHC-SD04-06D			
43-SHC-SD03-612			8
43-EC-SD02-06			
43-EC-SD01-06	PnPs		
43-EC-SD01-06D			
43-SHC-SD04-06D			
43-SHC-SD03-612			
43-EC-SD02-06			

TABLE 4-1 (Continued)

**SUMMARY OF REJECTED DATA
SITE 43, AGAN STREET DUMP
REMEDIAL INVESTIGATION, CTO-0303
MCAS, NEW RIVER, NORTH CAROLINA**

Comments:

1. Reject all results for the re-analyzed sample(s) in favor of the original sample(s) due to noncompliant internal standard areas.
2. Reject results in favor of the re-extracted sample results due to non compliant surrogate recoveries.
3. For the specified compounds, reject results in favor of the diluted analysis for the sample. Results for all other compounds are from the undiluted analysis.
4. Reject all nondetect results because the surrogate recoveries were less than 10%.
5. Reject all nondetect results because the matrix spike recovery was below 30%.
6. Reject all nondetected results due to DCB recoveries below 10%.
7. Reject results due to noncompliant surrogate recoveries and/or internal standard areas.
8. Reject all nondetect results for base/neutrals due to noncompliant surrogate recoveries.

TABLE 4-2

SUMMARY OF SITE CONTAMINATION
 SITE 43, AGAN STREET DUMP
 REMEDIAL INVESTIGATION, CTO-0303
 MCAS, NEW RIVER, NORTH CAROLINA

Media	Fraction	Detected Contaminants	Comparison Criteria		Site Contamination				
			Standard	Base Background	Min.	Max.	Max. Location	Detection Frequency	Distribution
Surface Soil	Volatiles	ND	NA	NA				0/7	
	Semivolatiles	4-Methylphenol	NA	NA	120	120	DA1-SB02	1/28	northeastern portion of site
		2-Methylnaphthalene	NA	NA	74	74	WA-SB01A	1/28	clearing adjacent to 43-GW01
		Acenaphthylene	NA	NA	71	71	WA-SB01A3	1/28	clearing adjacent to 43-GW01
		Acenaphthene (PAH)	NA	NA	45	2,100	WA-SB01A	3/28	clearing adjacent to 43-GW01
		Dibenzofuran	NA	NA	35	870	WA-SB01A	2/28	clearing adjacent to 43-GW01
		Fluorene (PAH)	NA	NA	53	1,700	WA-SB01A	3/28	clearing adjacent to 43-GW01
		Phenanthrene (PAH)	NA	NA	54	5,900	WA-SB01A	8/28	clearing adjacent to 43-GW01
		Anthracene (PAH)	NA	NA	44	820	WA-SB01A	3/28	clearing adjacent to 43-GW01
		Carbazole	NA	NA	99	350	WA-SB01A	5/28	clearing adjacent to 43-GW01
		Fluoranthene (PAH)	NA	NA	49	60,000	WA-SB01A	10/28	clearing adjacent to 43-GW01
		Pyrene (PAH)	NA	NA	49	64,000	WA-SB01A	10/28	clearing adjacent to 43-GW01
		Butylbenzylphthalate	NA	NA	50	420	OA-SB03	3/28	maximum northeast of clearing
		B(a)anthracene (PAH)	NA	NA	51	40,000	WA-SB01A	9/28	clearing adjacent to 43-GW01
		Chrysene (PAH)	NA	NA	110	46,000	WA-SB01A	9/28	clearing adjacent to 43-GW01
		B(b)fluoranthene (PAH)	NA	NA	44	52,000	WA-SB01A	10/28	clearing adjacent to 43-GW01
		B(k)fluoranthene (PAH)	NA	NA	57	20,000	WA-SB01A	9/28	clearing adjacent to 43-GW01
		Benzo(a)pyrene (PAH)	NA	NA	79	39,000	WA-SB01A	9/28	clearing adjacent to 43-GW01
		I(1,2,3-cd)pyrene (PAH)	NA	NA	42	27,000	WA-SB01A	10/28	clearing adjacent to 43-GW01
		D(a,h)anthracene (PAH)	NA	NA	47	1,200	WA-SB01A	8/28	clearing adjacent to 43-GW01
B(g,h,i)perylene (PAH)	NA	NA	87	24,000	WA-SB01A	9/28	clearing adjacent to 43-GW01		

TABLE 4-2 (Continued)

SUMMARY OF SITE CONTAMINATION
 SITE 43, AGAN STREET DUMP
 REMEDIAL INVESTIGATION, CTO-0303
 MCAS, NEW RIVER, NORTH CAROLINA

Media	Fraction	Detected Contaminants	Comparison Criteria		Site Contamination				
			Standard	Base Background	Min.	Max.	Max. Location	Detection Frequency	Distribution
Surface Soil (Continued)	Pesticides	Heptachlor epoxide	NA	NA	2	2	WA-SB01A	1/7	clearing adjacent to 43-GW01
		4-4'-DDE	NA	NA	5.7	1,000	DA1-SB03	5/7	maximum northeast
		4-4'-DDD	NA	NA	3,000	3,000	DA1-SB03	1/7	northeastern portion of site
		4-4'-DDT	NA	NA	10	1,000	DA1-SB03	4/7	maximum northeast
		Endrin aldehyde	NA	NA	5.4	5.4	DA2-SB03	1/7	north of clearing
	PCBs	ND	NA	NA				0/7	
	Metals (1)	Cadmium	NA	0.7	0.74	1.70	WA-SB02	2/21	2 exceed BB, separate areas
		Chromium	NA	6.7	1.1	106	DA1-SB02	21/21	11 exceed BB, scattered
		Copper	NA	7.2	0.5	55.7	DA2-SB01	17/21	3 exceed BB, north of clearing
		Lead	NA	23.7	4.3	246	DA2-SB01	20/21	8 exceed BB, scattered
		Manganese	NA	18.5	2.8	189	DA2-SB01	21/21	5 exceed BB, scattered
		Mercury	NA	0.1	0.1	0.5	DA1-SB02	3/21	3 exceed BB, drum areas
		Nickel	NA	3.4	1.1	5	DA2-SB01	8/21	3 exceed BB, scattered
Zinc	NA	13.9	1.5	595	DA1-SB02	21/21	9 exceed BB, scattered		
Subsurface Soil	Volatiles	ND	NA	NA				0/7	
	Semivolatiles	Phenanthrene (PAH)	NA	NA	430	430	WA-SB02	1/20	clearing adjacent to 43-GW01
		Carbazole	NA	NA	73	73	WA-SB02	1/20	clearing adjacent to 43-GW01
		Fluoranthene (PAH)	NA	NA	850	850	WA-SB02	1/20	clearing adjacent to 43-GW01
		Pyrene (PAH)	NA	NA	1,800	1,800	WA-SB02	1/20	clearing adjacent to 43-GW01
		Butylbenzylphtalate	NA	NA	39	440	OA-SB03	2/20	north of clearing
		B(a)anthracene (PAH)	NA	NA	390	390	WA-SB02	1/20	clearing adjacent to 43-GW01
Chrysene (PAH)	NA	NA	740	740	WA-SB02	1/20	clearing adjacent to 43-GW01		

TABLE 4-2 (Continued)

**SUMMARY OF SITE CONTAMINATION
SITE 43, AGAN STREET DUMP
REMEDIAL INVESTIGATION, CTO-0303
MCAS, NEW RIVER, NORTH CAROLINA**

Media	Fraction	Detected Contaminants	Comparison Criteria		Site Contamination				
			Standard	Base Background	Min.	Max.	Max. Location	Detection Frequency	Distribution
Subsurface Soil (Continued)	Semivolatiles (Continued)	B(b)fluoranthene (PAH)	NA	NA	780	780	WA-SB02	1/20	clearing adjacent to 43-GW01
		B(k)fluoranthene (PAH)	NA	NA	340	340	WA-SB02	1/20	clearing adjacent to 43-GW01
		Benzo(a)pyrene (PAH)	NA	NA	570	570	WA-SB02	1/20	clearing adjacent to 43-GW01
		I(1,2,3-cd)pyrene (PAH)	NA	NA	890	890	WA-SB02	1/20	clearing adjacent to 43-GW01
		B(g,h,i)perylene (PAH)	NA	NA	790	790	WA-SB02	1/20	clearing adjacent to 43-GW01
	Pesticides	4,4'-DDE	NA	NA	9	9	DA1-SB03	1/7	northeastern portion of site
		4,4'-DDD	NA	NA	1,200	1,200	DA1-SB03	1/7	northeastern portion of site
		4,4'-DDT	NA	NA	45	45	DA1-SB03	1/7	northeastern portion of site
	PCBs	ND	NA	NA				0/7	
	Metals (1)	Copper	NA	2.4	0.4	3.6	OA-SB01	6/20	1 exceeds BB, north of clearing
Groundwater	Volatiles	ND	NCWQS/MCL	NA				0/10	
	Semivolatiles	4-Methylphenol	NA	NA	2	2	43-TW04	1/10	north near SHC and EC
	Pesticides	ND	NCWQS/MCL	NA				0/10	
	PCBs	ND	NCWQS/MCL	NA				0/6	
	Total Metals	Iron	NCWQS - 300	NA	109	33,800	43-TW04	10/10	8 exceed standard, scattered
		Manganese	NCWQS - 50	NA	4.4	107	43-TW04	10/10	2 exceed standard, central and north
Surface Water (2)	Volatiles	1,2-Dichloroethene (total)	NCWQS - 7.0	NA	2	2	EC-SW02	2/6	neither exceed standard, EC
	Semivolatiles	ND	NCWQS/NOAA	NA				0/6	
	Pesticides	4,4'-DDE	WQS - 0.00059	NA	0.1	0.1	EC-SW01	2/6	both exceed standard, 1 EC, 1 SHC
		4,4'-DDD	WQS - 0.00084	NA	0.1	0.6	EC-SW01	3/6	3 exceed standard, 1 EC, 2 SHC
	PCBs	ND	NCWQS/NOAA	NA				0/6	
	Metals (3)	Copper	NCWQS - 3	129	1.8	3.2	EC-SW02	3/6	1 exceeds standard, not BB
Sediment	Volatiles	Carbon Disulfide	NA	NA	3	26	EC-SD02	3/12	2 from EC and 1 from SHC
	Semivolatiles	4-Methylphenol	NA	NA	210	210	SHC-SD03	1/12	adjacent to study area, SHC
		Pyrene (PAH)	NOAA - 350	NA	200	200	EC-SD02	1/12	does not exceed standard, EC
		Benzo(a)pyrene (PAH)	NOAA - 400	NA	290	1,900	SHC-SD02	4/12	3 exceed standard, 2 EC and 1 SHC

TABLE 4-2 (Continued)

SUMMARY OF SITE CONTAMINATION
 SITE 43, AGAN STREET DUMP
 REMEDIAL INVESTIGATION, CTO-0303
 MCAS, NEW RIVER, NORTH CAROLINA

Media	Fraction	Detected Contaminants	Comparison Criteria		Site Contamination				
			Standard	Base Background	Min.	Max.	Max. Location	Detection Frequency	Distribution
Sediment (Continued)	Pesticides	4,4'-DDE	NOAA - 2	NA	12	8,900	SHC-SD04	10/12	10 exceed standard, scattered
		Endrin	NA	NA	12	16	EC-SD01	2/11	1 detection EC and 1 SHC
		4,4'-DDD	NOAA - 2	NA	5.6	37,000	SHC-SD04	11/12	11 exceed standard, scattered
		4,4'-DDT	NOAA - 1	NA	9.3	180	EC-SD01	6/12	6 exceed standard, scattered
		alpha-Chlordane	NOAA - 0.5	NA	7.2	49	SHC-SD03	8/12	8 exceed standard, scattered
		gamma-Chlordane	NOAA - 0.5	NA	9.6	74	SHC-SD03	9/12	9 exceed standard, scattered
	PCBs	ND	NOAA	NA				0/9	
	Metals (3)	Lead	NOAA - 35	314	6.1	206	SHC-SD03	12/12	7 exceed standard, none exceed BB
		Mercury	NOAA - 0.15	ND	0.4	0.7	EC-SD01	2/12	2 exceed standard
		Silver	NOAA - 1	7.3	1.9	2.8	EC-SD02	2/12	2 exceed standard, neither exceed BB
		Zinc	NOAA - 120	926	1.5	338	EC-SD01	12/12	4 exceed standard, none exceed BB

Notes:

- Concentrations are presented in µg/L for liquid and µg/Kg for solids (ppb), metal concentrations for soils and sediments are presented in mg/Kg (ppm).
 - (1) Metals in both surface and subsurface soils were compared to twice the average base background positive concentrations for priority pollutant metals only (i.e., antimony, arsenic, beryllium, cadmium, chromium, copper, lead, mercury, nickel, selenium, silver, thallium, zinc).
 - (2) Positive contaminant detections in surface water were compared to appropriate NCWQS and NOAA saltwater screening values.
 - (3) Total metals in surface water and sediment were also compared to the maximum positive detections in upgradient samples at MCB, Camp Lejeune.
- BB - Base background, value equals two times average value for soil and the maximum value for surface water and sediment (refer to Appendix P)
- BEHP - bis(2-ethylhexyl)phthalate
- EC - Edwards Creek
- NA - Not applicable
- NCWQS - North Carolina Water Quality Standard
- ND - Not detected
- NOAA - National Oceanic and Atmospheric Administration
- MCL - Federal Maximum Contaminant Level
- PAH - Polynuclear aromatic hydrocarbon
- SHC - Strawhorn Creek

TABLE 4-3
SURFACE SOIL - POSITIVE DETECTION SUMMARY
SITE 43, AGAN STREET DUMP
REMEDIAL INVESTIGATION, CTO-0303
MCAS, NEW RIVER, NORTH CAROLINA
TCL ORGANICS

LOCATION	43-DA1-SB01-00	43-DA1-SB02-00	43-DA1-SB03-00	43-DA2-SB01-00	43-DA2-SB02-00	43-GW01DW-00
DATE SAMPLED	03/10/95	03/10/95	03/10/95	03/10/95	03/10/95	02/28/95
DEPTH	0-12"	0-12"	0-12"	0-12"	0-12"	0-12"
UNITS	UG/KG	UG/KG	UG/KG	UG/KG	UG/KG	UG/KG
SEMIVOLATILE						
4-METHYLPHENOL	430 U	120 J	530 U	540 U	450 U	390 U
2-METHYLNAPHTHALENE	430 U	500 U	530 U	540 U	450 U	390 U
ACENAPHTHYLENE	430 U	500 U	530 U	540 U	450 U	390 U
ACENAPHTHENE	430 U	500 U	530 U	540 U	450 U	390 U
DIBENZOFURAN	430 U	500 U	530 U	540 U	450 U	390 U
FLUORENE	430 U	500 U	530 U	540 U	450 U	390 U
PHENANTHRENE	430 U	500 U	530 U	540 U	450 U	720
ANTHRACENE	430 U	500 U	530 U	540 U	450 U	44 J
CARBAZOLE	430 U	500 U	530 U	540 U	450 U	99 J
FLUORANTHENE	430 U	500 U	530 U	540 U	450 U	1400
PYRENE	430 U	500 U	530 U	540 U	450 U	1100
BUTYLBENZYLPHTHALATE	430 U	500 U	530 U	540 U	450 U	390 U
BENZO(A)ANTHRACENE	430 U	500 U	530 U	540 U	450 U	570
CHRYSENE	430 U	500 U	530 U	540 U	450 U	1000
BIS(2-ETHYLHEXYL)PHTHALATE	430 U	500 U	530 U	260 J	450 U	94 J
BENZO(B)FLUORANTHENE	430 U	500 U	530 U	540 U	450 U	1500
BENZO(K)FLUORANTHENE	430 U	500 U	530 U	540 U	450 U	580
BENZO(A)PYRENE	430 U	500 U	530 U	540 U	450 U	760
INDENO(1,2,3-CD)PYRENE	430 U	500 U	530 U	540 U	450 U	500
DIBENZO(A,H)ANTHRACENE	430 U	500 U	530 U	540 U	450 U	110 J
BENZO(G,H,I)PERYLENE	430 U	500 U	530 U	540 U	450 U	420
PESTICIDE/PCBS						
HEPTACHLOR EPOXIDE	NA	NA	2.7 U	2.7 U	NA	2 UJ
4,4'-DDE	NA	NA	1000 J	15	NA	3.9 UJ
4,4'-DDD	NA	NA	3000	5.4 U	NA	3.9 UJ
4,4'-DDT	NA	NA	1000 J	19 J	NA	3.9 UJ
ENDRIN ALDEHYDE	NA	NA	5.4 U	5.4 J	NA	3.9 UJ

UG/KG - microgram per kilogram
J - value is estimated
NA - not analyzed
U - not detected
UJ - not detected, value is estimated

TABLE 4-3
SURFACE SOIL - POSITIVE DETECTION SUMMARY
SITE 43, AGAN STREET DUMP
REMEDIAL INVESTIGATION, CTO-0303
MCAS, NEW RIVER, NORTH CAROLINA
TCL ORGANICS

LOCATION	43-MA-SB01-00	43-MA-SB02-00	43-MA-SB03-00	43-MA-SB04-00	43-MA-SB05-00	43-OA-SB01-00
DATE SAMPLED	02/28/95	02/28/95	02/28/95	02/28/95	02/28/95	03/10/95
DEPTH	0-12"	0-12"	0-12"	0-12"	0-12"	0-12"
UNITS	UG/KG	UG/KG	UG/KG	UG/KG	UG/KG	UG/KG
SEMIVOLATILE						
4-METHYLPHENOL	410 U	400 U	430 U	490 U	400 U	470 U
2-METHYLNAPHTHALENE	410 U	400 U	430 U	490 U	400 U	470 U
ACENAPHTHYLENE	410 U	400 U	430 U	490 U	400 U	470 U
ACENAPHTHENE	410 U	400 U	430 U	490 U	400 U	470 U
DIBENZOFURAN	410 U	400 U	430 U	490 U	400 U	470 U
FLUORENE	410 U	400 U	430 U	490 U	400 U	470 U
PHENANTHRENE	410 U	400 U	430 U	490 U	400 U	470 U
ANTHRACENE	410 U	400 U	430 U	490 U	400 U	470 U
CARBAZOLE	410 U	400 U	430 U	490 U	400 U	470 U
FLUORANTHENE	410 U	400 U	430 U	490 U	400 U	470 U
PYRENE	410 U	400 U	430 U	490 U	400 UJ	470 U
BUTYLBENZYLPHTHALATE	410 U	400 U	430 U	490 U	400 UJ	470 U
BENZO(A)ANTHRACENE	410 U	400 U	430 U	490 U	400 UJ	470 U
CHRYSENE	410 U	400 U	430 U	490 U	400 UJ	470 U
BIS(2-ETHYLHEXYL)PHTHALATE	410 U	400 U	430 U	120 J	56 J	470 U
BENZO(B)FLUORANTHENE	410 U	400 U	430 U	490 U	400 U	470 U
BENZO(K)FLUORANTHENE	410 U	400 U	430 U	490 U	400 U	470 U
BENZO(A)PYRENE	410 U	400 U	430 U	490 U	400 U	470 U
INDENO(1,2,3-CD)PYRENE	410 U	400 U	430 U	490 U	400 U	470 U
DIBENZO(A,H)ANTHRACENE	410 U	400 U	430 U	490 U	400 U	470 U
BENZO(G,H,I)PERYLENE	410 U	400 U	430 U	490 U	400 U	470 U
PESTICIDE/PCBS						
HEPTACHLOR EPOXIDE	NA	NA	2.1 U	NA	NA	NA
4,4'-DDE	NA	NA	26	NA	NA	NA
4,4'-DDD	NA	NA	4.3 U	NA	NA	NA
4,4'-DDT	NA	NA	30	NA	NA	NA
ENDRIN ALDEHYDE	NA	NA	4.3 UJ	NA	NA	NA

UG/KG - microgram per kilogram
J - value is estimated
NA - not analyzed
U - not detected
UJ - not detected, vaue is estimated

TABLE 4-3
SURFACE SOIL - POSITIVE DETECTION SUMMARY
SITE 43, AGAN STREET DUMP
REMEDIAL INVESTIGATION, CTO-0303
MCAS, NEW RIVER, NORTH CAROLINA
TCL ORGANICS

LOCATION	43-OA-SB02-00	43-OA-SB03-00	43-OA-SB04-00	43-OA-SB05-00	43-OA-SB06-00	43-OA-SB07-00
DATE SAMPLED	03/10/95	03/10/95	03/10/95	03/06/95	03/06/95	03/06/95
DEPTH	0-12"	0-12"	0-12"	0-12"	0-12"	0-12"
UNITS	UG/KG	UG/KG	UG/KG	UG/KG	UG/KG	UG/KG
SEMIVOLATILE						
4-METHYLPHENOL	500 U	460 U	440 U	400 U	410 U	400 U
2-METHYLNAPHTHALENE	500 U	460 U	440 U	400 U	410 U	400 U
ACENAPHTHYLENE	500 U	460 U	440 U	400 U	410 U	400 U
ACENAPHTHENE	500 U	460 U	440 U	400 U	410 U	400 U
DIBENZOFURAN	500 U	460 U	440 U	400 U	410 U	400 U
FLUORENE	500 U	460 U	440 U	400 U	410 U	400 U
PHENANTHRENE	500 U	460 U	440 U	400 U	410 U	400 U
ANTHRACENE	500 U	460 U	440 U	400 U	410 U	400 U
CARBAZOLE	500 U	460 U	440 U	400 U	410 U	400 U
FLUORANTHENE	500 U	460 U	440 U	400 U	410 U	400 U
PYRENE	500 U	460 U	440 U	400 U	410 U	400 U
BUTYLBENZYLPHTHALATE	500 U	420 J	440 U	400 U	410 U	400 U
BENZO(A)ANTHRACENE	500 U	460 U	440 U	400 U	410 U	400 U
CHRYSENE	500 U	460 U	440 U	400 U	410 U	400 U
BIS(2-ETHYLHEXYL)PHTHALATE	500 U	430 J	440 U	400 U	410 U	400 U
BENZO(B)FLUORANTHENE	500 U	460 U	440 U	400 U	410 U	400 U
BENZO(K)FLUORANTHENE	500 U	460 U	440 U	400 U	410 U	400 U
BENZO(A)PYRENE	500 U	460 U	440 U	400 U	410 U	400 U
INDENO(1,2,3-CD)PYRENE	500 U	460 U	440 U	400 U	410 U	400 U
DIBENZO(A,H)ANTHRACENE	500 U	460 U	440 U	400 U	410 U	400 U
BENZO(G,H,I)PERYLENE	500 U	460 U	440 U	400 U	410 U	400 U
PESTICIDE/PCBS						
HEPTACHLOR EPOXIDE	2.5 U	NA	NA	2 U	NA	NA
4,4'-DDE	7.1	NA	NA	4 UJ	NA	NA
4,4'-DDD	5 U	NA	NA	4 U	NA	NA
4,4'-DDT	10	NA	NA	4 U	NA	NA
ENDRIN ALDEHYDE	5 U	NA	NA	4 U	NA	NA

UG/KG - microgram per kilogram
J - value is estimated
NA - not analyzed
U - not detected
UJ - not detected, vaue is estimated

TABLE 4-3
SURFACE SOIL - POSITIVE DETECTION SUMMARY
SITE 43, AGAN STREET DUMP
REMEDIAL INVESTIGATION, CTO-0303
MCAS, NEW RIVER, NORTH CAROLINA
TCL ORGANICS

LOCATION	43-WA-SB01-00	43-WA-SB01A-00	43-WA-SB01A1-00	43-WA-SB01A2-00	43-WA-SB01A3-00	43-WA-SB01A4-00
DATE SAMPLED	02/28/95	03/14/95	05/01/95	05/01/95	05/01/95	05/01/95
DEPTH	0-12"	0-12"	0-12"	0-12"	0-12"	0-12"
UNITS	UG/KG	UG/KG	UG/KG	UG/KG	UG/KG	UG/KG
SEMIVOLATILE						
4-METHYLPHENOL	400 U	400 U	340 U	370 U	340 U	350 U
2-METHYLNAPHTHALENE	400 U	74 J	340 U	370 U	340 U	350 U
ACENAPHTHYLENE	400 U	400 U	340 U	370 U	71 J	350 U
ACENAPHTHENE	400 U	2900	340 U	45 J	63 J	350 U
DIBENZOFURAN	400 U	870	340 U	370 U	35 J	350 U
FLUORENE	400 U	1700	340 U	53 J	59 J	350 U
PHENANTHRENE	260 J	5900 J	610	1000	1300	67 J
ANTHRACENE	400 U	820	340 U	370 U	210 J	350 U
CARBAZOLE	400 U	350 J	120 J	260 J	300 J	350 U
FLUORANTHENE	530	60000	1500	2200	6400	230 J
PYRENE	470	64000	1200	2100	6500	170 J
BUTYLBENZYLPHTHALATE	400 U	400 U	340 U	50 J	100 J	350 U
BENZO(A)ANTHRACENE	190 J	41000	560	980	3200	51 J
CHRYSENE	370 J	46000	890	1500	4500	110 J
BIS(2-ETHYLHEXYL)PHTHALATE	82 J	400 U	340 U	500 U	480 U	350 U
BENZO(B)FLUORANTHENE	410	52000	1100	2300	6800	170 J
BENZO(K)FLUORANTHENE	200 J	20000	420	700	1300	57 J
BENZO(A)PYRENE	260 J	39000	690	1300	4700	79 J
INDENO(1,2,3-CD)PYRENE	270 J	27000	590	1300	3600	90 J
DIBENZO(A,H)ANTHRACENE	73 J	1200	110 J	280 J	710	350 U
BENZO(G,H,I)PERYLENE	280 J	24000	560	1200	3400	87 J
PESTICIDE/PCBS						
HEPTACHLOR EPOXIDE	2 J	NA	NA	NA	NA	NA
4,4'-DDE	5.7 J	NA	NA	NA	NA	NA
4,4'-DDD	4.1 UJ	NA	NA	NA	NA	NA
4,4'-DDT	4.1 UJ	NA	NA	NA	NA	NA
ENDRIN ALDEHYDE	4.1 UJ	NA	NA	NA	NA	NA

UG/KG - microgram per kilogram
J - value is estimated
NA - not analyzed
U - not detected
UJ - not detected, vaue is estimated

TABLE 4-3
SURFACE SOIL - POSITIVE DETECTION SUMMARY
SITE 43, AGAN STREET DUMP
REMEDIAL INVESTIGATION, CTO-0303
MCAS, NEW RIVER, NORTH CAROLINA
TCL ORGANICS

LOCATION	43-WA-SB01B-00	43-WA-SB01C-00	43-WA-SB02-00	43-WA-SB03-00
DATE SAMPLED	03/14/95	03/14/95	02/28/95	02/28/95
DEPTH	0-12"	0-12"	0-12"	0-12"
UNITS	UG/KG	UG/KG	UG/KG	UG/KG
SEMIVOLATILE				
4-METHYLPHENOL	410 U	350 U	420 U	400 U
2-METHYLNAPHTHALENE	410 U	350 U	420 U	400 U
ACENAPHTHYLENE	410 U	350 U	420 U	400 U
ACENAPHTHENE	410 U	350 U	420 U	400 U
DIBENZOFURAN	410 U	350 U	420 U	400 U
FLUORENE	410 U	350 U	420 U	400 U
PHENANTHRENE	410 U	54 J	420 U	400 U
ANTHRACENE	410 U	350 U	420 U	400 U
CARBAZOLE	410 U	350 U	420 U	400 U
FLUORANTHENE	130 J	350	420 U	49 J
PYRENE	150 J	430	420 U	49 J
BUTYLBENZYLPHTHALATE	410 U	350 U	420 U	400 U
BENZO(A)ANTHRACENE	67 J	260 J	420 U	400 U
CHRYSENE	120 J	340 J	420 U	400 U
BIS(2-ETHYLHEXYL)PHTHALATE	43 J	45 J	66 J	220 J
BENZO(B)FLUORANTHENE	600	500	420 U	44 J
BENZO(K)FLUORANTHENE	280 J	200 J	420 U	400 U
BENZO(A)PYRENE	770	480	420 U	400 U
INDENO(1,2,3-CD)PYRENE	590	550	420 U	42 J
DIBENZO(A,H)ANTHRACENE	110 J	47 J	420 U	400 U
BENZO(G,H,I)PERYLENE	380 J	460	420 U	400 U
PESTICIDE/PCBS				
HEPTACHLOR EPOXIDE	NA	NA	NA	NA
4,4'-DDE	NA	NA	NA	NA
4,4'-DDD	NA	NA	NA	NA
4,4'-DDT	NA	NA	NA	NA
ENDRIN ALDEHYDE	NA	NA	NA	NA

UG/KG - microgram per kilogram
 J - value is estimated
 NA - not analyzed
 U - not detected
 UJ - not detected, vaue is estimated

TABLE 4-4
 SURFACE SOIL - POSITIVE DETECTION SUMMARY
 SITE 43, AGAN STREET DUMP
 REMEDIAL INVESTIGATION, CTO-0303
 MCAS, NEW RIVER, NORTH CAROLINA
 TAL METALS

LOCATION	43-DA1-SB01-00	43-DA1-SB02-00	43-DA1-SB03-00	43-DA2-SB01-00	43-DA2-SB02-00	43-GW01DW-00
DATE SAMPLED	03/10/95	03/10/95	03/10/95	03/10/95	03/10/95	02/28/95
DEPTH	0-12"	0-12"	0-12"	0-12"	0-12"	0-12"
UNITS	MG/KG	MG/KG	MG/KG	MG/KG	MG/KG	MG/KG
ALUMINUM, TOTAL	4980 J	2680 J	2300	3380 J	2770 J	1920 J
ARSENIC, TOTAL	0.37 U	0.49 U	0.59 UJ	0.89	0.49 U	0.55 J
BARIUM, TOTAL	30.7	21	23.7	26.8	10.2	11.7
CADMIUM, TOTAL	0.56 U	0.67 U	0.79 U	0.77 U	0.52 U	1.1 U
CALCIUM, TOTAL	2960	2770	2870	8200	3160	8280
CHROMIUM, TOTAL	5.3	106	11	52.3	2.6	8.9
COBALT, TOTAL	0.6 U	2.1	3.8	4.1	0.56 U	0.78
COPPER, TOTAL	3.5	4.8	5.5	55.7	8.9	3
IRON, TOTAL	2290	3560	2500	21100	1480	1830
LEAD, TOTAL	15.6	38.7	55.4	246	23.1	31.7
MAGNESIUM, TOTAL	202	181	169	287	91.5	153
MANGANESE, TOTAL	26.4	41.7	34	189	13.9	12.5
MERCURY, TOTAL	0.12	0.51	0.12 U	0.31	0.1 U	0.08 U
NICKEL, TOTAL	2.2 U	2.6 U	1.7	5	2 U	3.7
POTASSIUM, TOTAL	138 U	164 U	67.4	187 U	127 U	138 U
SELENIUM, TOTAL	0.36	0.39 U	0.47 UJ	0.61 J	0.39 U	0.36 UJ
SODIUM, TOTAL	45.8	39.5	22.1	36.2	21.9	25.3 U
VANADIUM, TOTAL	8.7	7.4	6.6	8.8	4.9	4.7
ZINC, TOTAL	16.2	595	478	348	23.9	34

MG/KG - milligram per kilogram
 J - value is estimated
 U - not detected
 UJ - not detected, value is estimated

TABLE 4-4
 SURFACE SOIL - POSITIVE DETECTION SUMMARY
 SITE 43, AGAN STREET DUMP
 REMEDIAL INVESTIGATION, CTO-0303
 MCAS, NEW RIVER, NORTH CAROLINA
 TAL METALS

LOCATION	43-MA-SB01-00	43-MA-SB02-00	43-MA-SB03-00	43-MA-SB04-00	43-MA-SB05-00	43-OA-SB01-00
DATE SAMPLED	02/28/95	02/28/95	02/28/95	02/28/95	02/28/95	03/10/95
DEPTH	0-12"	0-12"	0-12"	0-12"	0-12"	0-12"
UNITS	MG/KG	MG/KG	MG/KG	MG/KG	MG/KG	MG/KG
ALUMINUM, TOTAL	2030 J	8770	8890	2150	1060 J	2450 J
ARSENIC, TOTAL	0.36 J	0.87	0.83	0.75	0.72 J	0.45 U
BARIIUM, TOTAL	5.4	14.6	12.5	15.1	5.3	7.8
CADMIUM, TOTAL	0.61 U	0.6 U	0.61 U	0.78 U	0.64 U	0.55 U
CALCIUM, TOTAL	294	484 J	62.3 U	978 J	385	375
CHROMIUM, TOTAL	2	11 J	9.9	3.6 J	1.9	2.9
COBALT, TOTAL	0.65 U	0.64 U	0.49 U	0.84 U	0.63 U	0.59 U
COPPER, TOTAL	1.6 U	0.77	2.2	2.2	1.4 U	21.2
IRON, TOTAL	1510	4170	5400	1320	943	1370
LEAD, TOTAL	13.8	9	11.2 J	30.3	16.2	94.9
MAGNESIUM, TOTAL	62.7	338	287	90.4	64	87.3
MANGANESE, TOTAL	3	8.7 J	7.3	3.7 J	2.8	3.4
MERCURY, TOTAL	0.1 U	0.094 U	0.11 U	0.11 U	0.12 U	0.11 U
NICKEL, TOTAL	2.4 U	3.7	1.9	3.2	2.3 U	2.1 U
POTASSIUM, TOTAL	149 U	152	171	191 U	143 U	134 U
SELENIUM, TOTAL	0.35 UJ	0.43 U	0.37 U	0.53 U	0.41 UJ	0.36 U
SODIUM, TOTAL	13.4 U	48.5	16.7 U	37.6 U	13 U	12.3
VANADIUM, TOTAL	5.3	13.9	17.3	10.9	4.6	4
ZINC, TOTAL	3.4	13.1	4.6	16.4	12.1	5.7

MG/KG - milligram per kilogram

J - value is estimated

U - not detected

UJ - not detected, value is estimated

TABLE 4-4
 SURFACE SOIL - POSITIVE DETECTION SUMMARY
 SITE 43, AGAN STREET DUMP
 REMEDIAL INVESTIGATION, CTO-0303
 MCAS, NEW RIVER, NORTH CAROLINA
 TAL METALS

LOCATION	43-OA-SB02-00	43-OA-SB03-00	43-OA-SB04-00	43-OA-SB05-00	43-OA-SB06-00	43-OA-SB07-00
DATE SAMPLED	03/10/95	03/10/95	03/10/95	03/06/95	03/06/95	03/06/95
DEPTH	0-12"	0-12"	0-12"	0-12"	0-12"	0-12"
UNITS	MG/KG	MG/KG	MG/KG	MG/KG	MG/KG	MG/KG
ALUMINUM, TOTAL	2890 J	1490	1280 J	6880	5660	3260
ARSENIC, TOTAL	0.46 U	0.27 UJ	0.47 U	0.68	1.1	0.59 J
BARIUM, TOTAL	8	5.3	3.2	9.7	10.8	7.7
CADMIUM, TOTAL	0.72 U	0.76 U	0.67 U	0.65 U	0.67 U	0.74
CALCIUM, TOTAL	204	1730	94.6	174	39600	22200 J
CHROMIUM, TOTAL	2.3	2.2	1.1	7.1	6.7	6.1
COBALT, TOTAL	0.77 U	0.81 U	0.72 U	0.8	0.72 U	1.1 U
COPPER, TOTAL	2.9	0.68	0.46 U	0.92	0.47	2
IRON, TOTAL	1210	1220	844	3050	5320	2200 J
LEAD, TOTAL	28.4	10	4.3	7.9	7.6	3.7 U
MAGNESIUM, TOTAL	83.9	103	44.5	167	614	374
MANGANESE, TOTAL	4.3	3.4	3.2	6	10.6	11
MERCURY, TOTAL	0.12 U	0.13 U	0.1 U	0.09 U	0.09 U	0.095 U
NICKEL, TOTAL	2.8 U	2.9 U	2.6 U	2.5 U	2.6 U	1.1
POTASSIUM, TOTAL	177 U	185 U	164 U	159 U	165 U	169
SELENIUM, TOTAL	0.37 U	0.37 U	0.37 U	0.34 U	0.52	0.33 U
SODIUM, TOTAL	28.8	8.2 U	19.6	19	89.8	38
VANADIUM, TOTAL	4.3	4.5	3.1	10.5	12.3	7.7
ZINC, TOTAL	3.9	2.6	3.8	1.5	2.7	3.6

MG/KG - milligram per kilogram

J - value is estimated

U - not detected

UJ - not detected, value is estimated

TABLE 4-4
 SURFACE SOIL - POSITIVE DETECTION SUMMARY
 SITE 43, AGAN STREET DUMP
 REMEDIAL INVESTIGATION, CTO-0303
 MCAS, NEW RIVER, NORTH CAROLINA
 TAL METALS

LOCATION	43-WA-SB01-00	43-WA-SB02-00	43-WA-SB03-00
DATE SAMPLED	02/28/95	02/28/95	02/28/95
DEPTH	0-12"	0-12"	0-12"
UNITS	MG/KG	MG/KG	MG/KG
ALUMINUM, TOTAL	2380	1750 J	2050 J
ARSENIC, TOTAL	0.33	0.53 J	0.52 J
BARIUM, TOTAL	11.8	551	7.2
CADMIUM, TOTAL	0.57 U	1.7	0.65 U
CALCIUM, TOTAL	39100	23900	1190
CHROMIUM, TOTAL	4.6	17.9	2.5
COBALT, TOTAL	0.46 U	0.73 U	0.69 U
COPPER, TOTAL	2.9	6.1	1.2 U
IRON, TOTAL	2260	1690	1680
LEAD, TOTAL	14.7 J	30.8	10.5
MAGNESIUM, TOTAL	419	301	97.8
MANGANESE, TOTAL	19	14.4	7.9
MERCURY, TOTAL	0.12 U	0.11 U	0.1 U
NICKEL, TOTAL	1.5	2.6 U	2.5 U
POTASSIUM, TOTAL	111	166 U	159 U
SELENIUM, TOTAL	0.27 U	0.31 UJ	0.31 UJ
SODIUM, TOTAL	73.4	47.8 U	23.2
VANADIUM, TOTAL	5.1	5.7	4.1
ZINC, TOTAL	16.5	30.4	5.6

MG/KG - milligram per kilogram
 J - value is estimated
 U - not detected
 UJ - not detected, value is estimated

TABLE 4-5
 SUBSURFACE SOIL - POSITIVE DETECTION SUMMARY
 SITE 43, AGAN STREET DUMP
 REMEDIAL INVESTIGATION, CTO-0303
 MCAS, NEW RIVER, NORTH CAROLINA
 TCL ORGANICS

LOCATION	43-DA1-SB01-01	43-DA1-SB02-01	43-DA1-SB03-01	43-DA2-SB01-01	43-DA2-SB02-01	43-GW01DW-01
DATE SAMPLED	03/10/95	03/10/95	03/10/95	03/10/95	03/10/95	02/28/95
DEPTH	1-3'	1-3'	1-3'	1-3'	1-3'	1-3'
UNITS	UG/KG	UG/KG	UG/KG	UG/KG	UG/KG	UG/KG
SEMIVOLATILE						
PHENANTHRENE	400 U	380 U	370 U	400 U	410 U	380 U
CARBAZOLE	400 U	380 U	370 U	400 U	410 U	380 U
FLUORANTHENE	400 U	380 U	370 U	400 U	410 U	380 U
PYRENE	400 U	380 U	370 U	400 U	410 U	380 U
BUTYLBENZYLPHthalate	400 U	380 U	370 U	400 U	410 U	380 U
BENZO(A)ANTHRACENE	400 U	380 U	370 U	400 U	410 U	380 U
CHRYSENE	400 U	380 U	370 U	400 U	410 U	380 U
BIS(2-ETHYLHEXYL)PHthalate	400 U	380 U	370 U	400 U	410 U	380 U
BENZO(B)FLUORANTHENE	400 U	380 U	370 U	400 U	410 U	380 U
BENZO(K)FLUORANTHENE	400 U	380 U	370 U	400 U	410 U	380 U
BENZO(A)PYRENE	400 U	380 U	370 U	400 U	410 U	380 U
INDENO(1,2,3-CD)PYRENE	400 U	380 U	370 U	400 U	410 U	380 U
DIBENZO(A,H)ANTHRACENE	400 U	380 U	370 U	400 U	410 U	380 U
BENZO(G,H,I)PERYLENE	400 U	380 U	370 U	400 U	410 U	380 U
PESTICIDE/PCBS						
4,4'-DDE	NA	NA	9.1 J	4 U	NA	3.9 UJ
4,4'-DDD	NA	NA	1200	4 U	NA	3.9 UJ
4,4'-DDT	NA	NA	45 J	4 U	NA	3.9 UJ

UG/KG - microgram per kilogram
 J - value is estimated
 NA - not analyzed
 U - not detected
 UJ - not detected, not analyzed

TABLE 4-5
SUBSURFACE SOIL - POSITIVE DETECTION SUMMARY
SITE 43, AGAN STREET DUMP
REMEDIAL INVESTIGATION, CTO-0303
MCAS, NEW RIVER, NORTH CAROLINA
TCL ORGANICS

LOCATION	43-MA-SB01-01	43-MA-SB02-02	43-MA-SB03-01	43-MA-SB04-01	43-MA-SB05-02	43-OA-SB01-01
DATE SAMPLED	02/28/95	02/28/95	02/28/95	02/28/95	02/28/95	03/10/95
DEPTH	1-3'	3-5'	1-3'	1-3'	3-5'	1-3'
UNITS	UG/KG	UG/KG	UG/KG	UG/KG	UG/KG	UG/KG
SEMIVOLATILE						
PHENANTHRENE	390 U	390 U	400 U	390 U	400 U	410 U
CARBAZOLE	390 U	390 U	400 U	390 U	400 U	410 U
FLUORANTHENE	390 U	390 U	400 U	390 U	400 U	410 U
PYRENE	390 U	390 U	400 U	390 U	400 U	410 U
BUTYLBENZYLPHTHALATE	390 U	390 U	400 U	390 U	400 U	410 U
BENZO(A)ANTHRACENE	390 U	390 U	400 U	390 U	400 U	410 U
CHRYSENE	390 U	390 U	400 U	390 U	400 U	410 U
BIS(2-ETHYLHEXYL)PHTHALATE	390 U	390 U	400 U	390 U	400 U	410 U
BENZO(B)FLUORANTHENE	390 U	390 U	400 U	390 U	400 U	410 U
BENZO(K)FLUORANTHENE	390 U	390 U	400 U	390 U	400 U	410 U
BENZO(A)PYRENE	390 U	390 U	400 U	390 U	400 U	410 U
INDENO(1,2,3-CD)PYRENE	390 U	390 U	400 U	390 U	400 U	410 U
DIBENZO(A,H)ANTHRACENE	390 U	390 U	400 U	390 U	400 U	410 U
BENZO(G,H,I)PERYLENE	390 U	390 U	400 U	390 U	400 U	410 U
PESTICIDE/PCBS						
4,4'-DDE	NA	NA	3.9 U	NA	NA	NA
4,4'-DDD	NA	NA	3.9 U	NA	NA	NA
4,4'-DDT	NA	NA	3.9 U	NA	NA	NA

UG/KG - microgram per kilogram
J - value is estimated
NA - not analyzed
U - not detected
UJ - not detected, not analyzed

TABLE 4-5
 SUBSURFACE SOIL - POSITIVE DETECTION SUMMARY
 SITE 43, AGAN STREET DUMP
 REMEDIAL INVESTIGATION, CTO-0303
 MCAS, NEW RIVER, NORTH CAROLINA
 TCL ORGANICS

LOCATION	43-OA-SB02-01	43-OA-SB03-01	43-OA-SB04-01	43-OA-SB05-02	43-OA-SB06-02	43-WA-SB01-01
DATE SAMPLED	03/10/95	03/10/95	03/10/95	03/06/95	03/06/95	02/28/95
DEPTH	1-3'	1-3'	1-3'	3-5'	3-5'	1-3'
UNITS	UG/KG	UG/KG	UG/KG	UG/KG	UG/KG	UG/KG
SEMIVOLATILE						
PHENANTHRENE	400 U	400 U	390 U	400 U	390 U	390 U
CARBAZOLE	400 U	400 U	390 U	400 U	390 U	390 U
FLUORANTHENE	400 U	400 U	390 U	400 U	390 U	390 U
PYRENE	400 U	400 U	390 U	400 U	390 U	390 U
BUTYLBENZYLPHthalATE	400 U	440	390 U	400 U	390 U	390 U
BENZO(A)ANTHRACENE	400 U	400 U	390 U	400 U	390 U	390 U
CHRYSENE	400 U	400 U	390 U	400 U	390 U	390 U
BIS(2-ETHYLHEXYL)PHTHALATE	400 U	530	390 U	400 U	390 U	390 U
BENZO(B)FLUORANTHENE	400 U	400 U	390 U	400 U	390 U	390 U
BENZO(K)FLUORANTHENE	400 U	400 U	390 U	400 U	390 U	390 U
BENZO(A)PYRENE	400 U	400 U	390 U	400 U	390 U	390 U
INDENO(1,2,3-CD)PYRENE	400 U	400 U	390 U	400 U	390 U	390 U
DIBENZO(A,H)ANTHRACENE	400 U	400 U	390 U	400 U	390 U	390 U
BENZO(G,H,I)PERYLENE	400 U	400 U	390 U	400 U	390 U	390 U
PESTICIDE/PCBS						
4,4'-DDE	3.9 U	NA	NA	4 UJ	NA	3.9 UJ
4,4'-DDD	3.9 U	NA	NA	4 U	NA	3.9 UJ
4,4'-DDT	3.9 U	NA	NA	4 U	NA	3.9 UJ

UG/KG - microgram per kilogram
 J - value is estimated
 NA - not analyzed
 U - not detected
 UJ - not detected, not analyzed

TABLE 4-5
SUBSURFACE SOIL - POSITIVE DETECTION SUMMARY
SITE 43, AGAN STREET DUMP
REMEDIAL INVESTIGATION, CTO-0303
MCAS, NEW RIVER, NORTH CAROLINA
TCL ORGANICS

LOCATION	43-WA-SB02-01	43-WA-SB03-01
DATE SAMPLED	02/28/95	02/28/95
DEPTH	1-3'	1-3'
UNITS	UG/KG	UG/KG
SEMIVOLATILE		
PHENANTHRENE	430	390 U
CARBAZOLE	73 J	390 U
FLUORANTHENE	850	390 U
PYRENE	1800 J	390 U
BUTYLBENZYLPHthalate	39 J	390 U
BENZO(A)ANTHRACENE	390 J	390 U
CHRYSENE	740 J	390 U
BIS(2-ETHYLHEXYL)PHthalate	180 J	390 U
BENZO(B)FLUORANTHENE	780	390 U
BENZO(K)FLUORANTHENE	340 J	390 U
BENZO(A)PYRENE	570	390 U
INDENO(1,2,3-CD)PYRENE	890	390 U
DIBENZO(A,H)ANTHRACENE	170 J	390 U
BENZO(G,H,I)PERYLENE	790	390 U
PESTICIDE/PCBS		
4,4'-DDE	NA	NA
4,4'-DDD	NA	NA
4,4'-DDT	NA	NA

UG/KG - microgram per kilogram

J - value is estimated

NA - not analyzed

U - not detected

UJ - not detected, not analyzed

TABLE 4-6
 SUBSURFACE SOIL - POSITIVE DETECTION SUMMARY
 SITE 43, AGAN STREET DUMP
 REMEDIAL INVESTIGATION, CTO-0303
 MCAS, NEW RIVER, NORTH CAROLINA
 TAL METALS

LOCATION	43-DA1-SB01-01	43-DA1-SB02-01	43-DA1-SB03-01	43-DA2-SB01-01	43-DA2-SB02-01	43-GW01DW-01
DATE SAMPLED	03/10/95	03/10/95	03/10/95	03/10/95	03/10/95	02/28/95
DEPTH	1-3'	1-3'	1-3'	1-3'	1-3'	1-3'
UNITS	MG/KG	MG/KG	MG/KG	MG/KG	MG/KG	MG/KG
ALUMINUM, TOTAL	3730 J	2940	5530	1600 J	1740 J	948 J
ARSENIC, TOTAL	0.41 U	0.38 UJ	0.36 UJ	0.39 U	0.37 U	0.23 UJ
BARIUM, TOTAL	7.4	7.1	11.2	3	3.3	3.3
CALCIUM, TOTAL	139	153	261	194	280	194
CHROMIUM, TOTAL	4.4	4.3	6.8	1.9	1.4	2.3
COBALT, TOTAL	0.53 U	0.49 U	0.62	0.68 U	0.54 U	0.69 U
COPPER, TOTAL	0.63	0.84 U	1.6	0.43 U	0.34 U	0.44 U
IRON, TOTAL	2780	2420	6680	432	358	422
LEAD, TOTAL	3.7	3.9	3.5	2.6	1.8	2.3
MAGNESIUM, TOTAL	139	93.7	143	35.2	33.5	44.9
MANGANESE, TOTAL	3.4	2.4	3.9	2.1 U	2 U	3.7
NICKEL, TOTAL	1.9 U	0.92	1.7	2.4 U	2 U	2.5 U
POTASSIUM, TOTAL	185	53.7	124	155 U	124 U	158 U
SELENIUM, TOTAL	0.32 U	0.3 UJ	0.29 UJ	0.31 U	0.29 U	0.32 UJ
SODIUM, TOTAL	44.4	30	35.1	10.7	15.4	18.4 U
VANADIUM, TOTAL	6.8	8.8	10	0.85	0.74	2.5 U
ZINC, TOTAL	1.5	2	2.9	1.5	0.69 U	1.6

MG/KG - milligram per kilogram
 J - value is estimated
 U - not detected
 UJ - not detected, not analyzed

TABLE 4-6
 SUBSURFACE SOIL - POSITIVE DETECTION SUMMARY
 SITE 43, AGAN STREET DUMP
 REMEDIAL INVESTIGATION, CTO-0303
 MCAS, NEW RIVER, NORTH CAROLINA
 TAL METALS

LOCATION	43-MA-SB01-01	43-MA-SB02-02	43-MA-SB03-01	43-MA-SB04-01	43-MA-SB05-02	43-OA-SB01-01
DATE SAMPLED	02/28/95	02/28/95	02/28/95	02/28/95	02/28/95	03/10/95
DEPTH	1-3'	3-5'	1-3'	1-3'	3-5'	1-3'
UNITS	MG/KG	MG/KG	MG/KG	MG/KG	MG/KG	MG/KG
ALUMINUM, TOTAL	5040 J	3600 J	5660	4640	1100 J	1390 J
ARSENIC, TOTAL	0.55 J	0.3 J	0.24 U	0.31 U	0.37 J	0.36 U
BARIUM, TOTAL	9.3	11.7	10.9	10.9	3.4	4.8
CALCIUM, TOTAL	78.2	91.7	113	101 J	72.8	147
CHROMIUM, TOTAL	4.8	5	7.2	6.5 J	2.1	1.1
COBALT, TOTAL	0.62 U	0.68 U	0.45 U	0.53 U	0.61 U	0.6 U
COPPER, TOTAL	0.42 U	0.68 U	0.78 U	0.4	0.39 U	3.6
IRON, TOTAL	788	896	2270	1380	815	357
LEAD, TOTAL	7.3	4.7	5.5 J	4.9	5.4	7.5
MAGNESIUM, TOTAL	118	121	179	197	45.9	31.5
MANGANESE, TOTAL	2.6	3.9	4	5.4 J	2.9	2.1 U
NICKEL, TOTAL	2.2 U	2.4 U	0.82 U	1.9 U	2.2 U	2.2 U
POTASSIUM, TOTAL	141 U	155 U	158	177	140 U	138 U
SELENIUM, TOTAL	0.35 UJ	0.34 UJ	0.28 U	0.35 U	0.4 UJ	0.29
SODIUM, TOTAL	15.1 U	21.8 U	37.9	17.5 U	9.9 U	24.1
VANADIUM, TOTAL	4.3	5.9	7.8	5.9	2.4 U	1.5
ZINC, TOTAL	1.6	1.7	1.7 U	1.8	2.2	3.7

MG/KG - milligram per kilogram

J - value is estimated

U - not detected

UJ - not detected, not analyzed

TABLE 4-6
 SUBSURFACE SOIL - POSITIVE DETECTION SUMMARY
 SITE 43, AGAN STREET DUMP
 REMEDIAL INVESTIGATION, CTO-0303
 MCAS, NEW RIVER, NORTH CAROLINA
 TAL METALS

LOCATION	43-OA-SB02-01	43-OA-SB03-01	43-OA-SB04-01	43-OA-SB05-02	43-OA-SB06-02	43-WA-SB01-01
DATE SAMPLED	03/10/95	03/10/95	03/10/95	03/06/95	03/06/95	02/28/95
DEPTH	1-3'	1-3'	1-3'	3-5'	3-5'	1-3'
UNITS	MG/KG	MG/KG	MG/KG	MG/KG	MG/KG	MG/KG
ALUMINUM, TOTAL	1130 J	513	3520 J	949	3290	884
ARSENIC, TOTAL	0.43 U	0.3 UJ	0.44	0.44 U	0.36 U	0.24 U
BARIUM, TOTAL	3.7	2 U	6	2.8 U	5.8	2.9
CALCIUM, TOTAL	17	139	21	144	403	181
CHROMIUM, TOTAL	1.3	1.7 U	5.6	1.8	4.8	2.2
COBALT, TOTAL	0.61 U	0.65 U	0.61 U	0.58 U	0.61 U	0.45 U
COPPER, TOTAL	0.5	0.41 U	0.44	0.37 U	0.39 U	0.78 U
IRON, TOTAL	596	317	3730	505	1350	414
LEAD, TOTAL	1.5	1.9	3.7	1.8	4.1	2.3 J
MAGNESIUM, TOTAL	37.1	22.1	103	29.7	83.9	37.4 U
MANGANESE, TOTAL	1.8 U	1.6	3.1	2.7	4	2.7
NICKEL, TOTAL	2.2 U	2.3 U	2.2 U	2.1 U	2.2	0.82 U
POTASSIUM, TOTAL	139 U	149 U	140 U	133 U	139 U	46.1 U
SELENIUM, TOTAL	0.34 U	0.42 U	0.34 U	0.35 U	0.28 U	0.28 U
SODIUM, TOTAL	6.4	6.6 U	12.1	5.9 U	13.6	4.5 U
VANADIUM, TOTAL	1.3	1.9 U	7.6	1.9	5.3	2.2 U
ZINC, TOTAL	1.8	0.82 U	1.3	0.74 U	1.4	1.1 U

MG/KG - milligram per kilogram
 J - value is estimated
 U - not detected
 UJ - not detected, not analyzed

TABLE 4-6
SUBSURFACE SOIL - POSITIVE DETECTION SUMMARY
SITE 43, AGAN STREET DUMP
REMEDIAL INVESTIGATION, CTO-0303
MCAS, NEW RIVER, NORTH CAROLINA
TAL METALS

LOCATION	43-WA-SB02-01	43-WA-SB03-01
DATE SAMPLED	02/28/95	02/28/95
DEPTH	1-3'	1-3'
UNITS	MG/KG	MG/KG
ALUMINUM, TOTAL	3280 J	1820 J
ARSENIC, TOTAL	0.35 J	0.24 UJ
BARIUM, TOTAL	7.1	4.4
CALCIUM, TOTAL	495	308
CHROMIUM, TOTAL	4.2	2.7
COBALT, TOTAL	0.84	0.64 U
COPPER, TOTAL	0.39 U	0.4 U
IRON, TOTAL	964	596
LEAD, TOTAL	6.9	3.1
MAGNESIUM, TOTAL	117	72.4
MANGANESE, TOTAL	3.7	3.7
NICKEL, TOTAL	2.2 U	2.3 U
POTASSIUM, TOTAL	140 U	146 U
SELENIUM, TOTAL	0.38 UJ	0.33 UJ
SODIUM, TOTAL	8 U	11.1 U
VANADIUM, TOTAL	3.9	2.6 U
ZINC, TOTAL	2.2	1.5

MG/KG - milligram per kilogram
 J - value is estimated
 U - not detected
 UJ - not detected, not analyzed

TABLE 4-7
GROUNDWATER - POSITIVE DETECTION SUMMARY
SITE 43, AGAN STREET DUMP
REMEDIAL INVESTIGATION, CTO-0303
MCAS, NEW RIVER, NORTH CAROLINA
TCL ORGANICS

LOCATION	43-GW01-01	43-GW01DW-01	43-GW02-01	43-GW03-01	43-GW04-01	43-GW04DW-01
DATE SAMPLED	04/04/95	04/05/95	04/07/95	04/06/95	04/06/95	04/04/95
UNITS	UG/L	UG/L	UG/L	UG/L	UG/L	UG/L
SEMIVOLATILE 4-METHYLPHENOL	10 U	10 U	10 U	10 U	10 U	10 U

UG/L - microgram per liter
 J - value is estimated
 U - not detected

TABLE 4-7
GROUNDWATER - POSITIVE DETECTION SUMMARY
SITE 43, AGAN STREET DUMP
REMEDIAL INVESTIGATION, CTO-0303
MCAS, NEW RIVER, NORTH CAROLINA
TCL ORGANICS

LOCATION	43-TW01-01	43-TW02-01	43-TW03-01	43-TW04-01
DATE SAMPLED	04/05/95	04/06/95	04/07/95	04/07/95
UNITS	UG/L	UG/L	UG/L	UG/L
SEMIVOLATILE				
4-METHYLPHENOL	10 U	11 U	11 U	2 J

UG/L - microgram per liter
 J - value is estimated
 U - not detected

**TABLE 4-8
GROUNDWATER - POSITIVE DETECTION SUMMARY
SITE 43, AGAN STREET DUMP
REMEDIAL INVESTIGATION, CTO-0303
MCAS, NEW RIVER, NORTH CAROLINA
TAL METALS**

LOCATION	43-GW01-01	43-GW01DW-01	43-GW02-01	43-GW03-01	43-GW04-01	43-GW04DW-01
DATE SAMPLED	04/04/95	04/05/95	04/07/95	04/06/95	04/06/95	04/04/95
UNITS	UG/L	UG/L	UG/L	UG/L	UG/L	UG/L
ALUMINUM, TOTAL	294	16.8 J	456	97.8	432	83.5 U
BARIUM, TOTAL	12.5	5.9 U	54.5 J	30.3	16.1	5.7 U
CALCIUM, TOTAL	61500	74000	3410	28100	22400	68700
COBALT, TOTAL	2.3 U	2.3 U	3.4 U	2.3 U	2.3 U	2.3 U
COPPER, TOTAL	60.9	4 U	4.8 U	4 U	4 U	4 U
IRON, TOTAL	187 J	997 J	1050	4530 J	494 J	649 J
LEAD, TOTAL	1.4	1.2 U	0.6 U	1.2 U	1.2 U	1.2 U
MAGNESIUM, TOTAL	1990	5360	2560	2570	1630	2390
MANGANESE, TOTAL	7.4	86.7	22.9	34.7	8	28.5
NICKEL, TOTAL	4.2 U	4.2 U	10.9 U	4.2 U	4.2 U	4.2 U
POTASSIUM, TOTAL	2510	5330	1850	900	1620	3120
SODIUM, TOTAL	5180	57200	13200	7010	5580	28000
VANADIUM, TOTAL	2.1 U	2.1 U	4 U	2.1 U	2.1 U	2.1 U
ZINC, TOTAL	16.1	1.9 U	15.4	2.7	2.2	2.1

UG/L - microgram per liter
J - value is estimated
U - not detected

TABLE 4-8
GROUNDWATER - POSITIVE DETECTION SUMMARY
SITE 43, AGAN STREET DUMP
REMEDIAL INVESTIGATION, CTO-0303
MCAS, NEW RIVER, NORTH CAROLINA
TAL METALS

LOCATION	43-TW01-01	43-TW02-01	43-TW03-01	43-TW04-01
DATE SAMPLED	04/05/95	04/06/95	04/07/95	04/07/95
UNITS	UG/L	UG/L	UG/L	UG/L
ALUMINUM, TOTAL	4190	225	820	25100
BARIUM, TOTAL	81.5	10.3	42.4	104
CALCIUM, TOTAL	24100	74200	3710	81800
COBALT, TOTAL	2.3 U	2.3 U	2.3 U	3.9
COPPER, TOTAL	4 U	4 U	4 U	4 U
IRON, TOTAL	1950 J	109 J	331 J	33800 J
LEAD, TOTAL	1.9	1.2 U	1.2 U	1.4
MAGNESIUM, TOTAL	4540	1050	1970	154000
MANGANESE, TOTAL	27.6	5	4.4	107
NICKEL, TOTAL	4.4	4.2 U	4.2 U	13
POTASSIUM, TOTAL	769	404	731	20200
SODIUM, TOTAL	33100	7100	12100	1130000
VANADIUM, TOTAL	5.1	2.1 U	2.1 U	5.4
ZINC, TOTAL	546	35.5	37.5	596

UG/L - microgram per liter
J - value is estimated
U - not detected

TABLE 4-9
GROUNDWATER - POSITIVE DETECTION SUMMARY
SITE 43, AGAN STREET DUMP
REMEDIAL INVESTIGATION, CTO-0303
MCAS, NEW RIVER, NORTH CAROLINA
TAL DISSOLVED METALS

LOCATION	43-GW04DWD-01
DATE SAMPLED	04/04/95
UNITS	UG/L
CALCIUM, SOLUBLE	66800
IRON, SOLUBLE	591 J
MAGNESIUM, SOLUBLE	2380
MANGANESE, SOLUBLE	29.1
POTASSIUM, SOLUBLE	2970
SODIUM, SOLUBLE	26600
VANADIUM, SOLUBLE	3.5
ZINC, SOLUBLE	3.8

UG/L. - microgm per liter
 J - value is estimated

TABLE 4-10
SURFACE WATER - POSITIVE DETECTION SUMMARY
SITE 43, AGAN STREET DUMP
REMEDIAL INVESTIGATION, CTO-0303
MCAS, NEW RIVER, NORTH CAROLINA
TCL ORGANICS

LOCATION	43-EC-SW01	43-EC-SW02	43-SHC-SW01	43-SHC-SW02	43-SHC-SW03	43-SHC-SW04
DATE SAMPLED	05/03/95	05/03/95	05/05/95	05/05/95	05/03/95	05/03/95
UNITS	UG/L	UG/L	UG/L	UG/L	UG/L	UG/L
VOLATILE						
1,2-DICHLOROETHENE (TOTAL)	2 J	2 J	10 U	10 U	10 UJ	10 U
SEMIVOLATILE						
BIS(2-ETHYLHEXYL)PHTHALATE	10 U	10 U	11 U	2 U	10 U	200
PESTICIDE/PCBS						
4,4'-DDE	0.097 J	0.1 UJ	0.1 U	0.099 UJ	0.095 J	0.099 UJ
4,4'-DDD	0.64 J	0.1 UJ	0.1 U	0.099 UJ	0.23	0.12 J

UG/L - milligram per liter
 J - value is estimated
 U - not detected
 UJ - not detected, value is estimated

TABLE 4-11
SURFACE WATER - POSITIVE DETECTION SUMMARY
SITE 43, AGAN STREET DUMP
REMEDIAL INVESTIGATION, CTO-0303
MCAS, NEW RIVER, NORTH CAROLINA
TAL METALS

LOCATION	43-EC-SW01	43-EC-SW02	43-SHC-SW01	43-SHC-SW02	43-SHC-SW03	43-SHC-SW04
DATE SAMPLED	05/03/95	05/03/95	05/05/95	05/05/95	05/03/95	05/03/95
UNITS	UG/L	UG/L	UG/L	UG/L	UG/L	UG/L
ALUMINUM, TOTAL	504	481	87.8 U	36.4 U	478	717
ARSENIC, TOTAL	1.7 UJ	1.8 J	1.7 U	1.7 U	2.5	1.7 U
BARIUM, TOTAL	33	34	28.8	35.9	36.5	35.2
CALCIUM, TOTAL	86900	91900	37200	48900	72200	85700
COPPER, TOTAL	2.1	3.2	1.8 U	1.8 U	1.8 U	1.8
IRON, TOTAL	675 J	670 J	4280 J	2720 J	913 J	872 J
LEAD, TOTAL	2.5 J	2.7 J	0.87 J	0.8 UJ	2 J	2.8 J
MAGNESIUM, TOTAL	150000	165000	8360	33100	120000	158000
MANGANESE, TOTAL	48.9	51.5	38	51.9	57.1	38.7
POTASSIUM, TOTAL	49500 J	55200 J	3480 J	12100 J	40300 J	52300 J
SODIUM, TOTAL	1260000	1370000	67600	288000	1010000	1310000
VANADIUM, TOTAL	2 U	2.7	2.8	2 U	3.4	2 U

UG/L - milligram per liter
 J - value is estimated
 U - not detected
 UJ - not detected, value is estimated

TABLE 4-12
SURFACE WATER - POSITIVE DETECTION SUMMARY
SITE 43, AGAN STREET DUMP
REMEDIAL INVESTIGATION, CTO-0303
MCAS, NEW RIVER, NORTH CAROLINA
TAL DISSOLVED METALS

LOCATION	43-EC-DSW01	43-EC-DSW02	43-SHC-DSW01	43-SHC-DSW02	43-SHC-DSW03	43-SHC-DSW04
DATE SAMPLED	05/03/95	05/03/95	05/05/95	05/05/95	05/03/95	05/03/95
UNITS	UG/L	UG/L	UG/L	UG/L	UG/L	UG/L
BARIUM, SOLUBLE	30.7	31	25.3	35.2	34.4	34.2
CALCIUM, SOLUBLE	86200	88900	36500	49600	72000	86500
COPPER, SOLUBLE	1.8 U	1.8 U	1.8 U	2.5	1.8 U	1.8 U
IRON, SOLUBLE	62.5 U	69.1 U	1330 J	942 J	172 U	99.6 U
MAGNESIUM, SOLUBLE	151000	160000	8610	33800	120000	160000
MANGANESE, SOLUBLE	27.3	23.1	36.9	53.6	48.3	27.4
POTASSIUM, SOLUBLE	49100 J	53100 J	3620 J	12300 J	39200 J	52300 J
SODIUM, SOLUBLE	1260000	1340000	70200	295000	1010000	1320000
VANADIUM, SOLUBLE	2.9	2 U	2 U	2 U	2.2	2 U

UG/L - microgram per liter
 J - value is estimated
 U - not detected

TABLE 4-13
SEDIMENT - POSITIVE DETECTION SUMMARY
SITE 43, AGAN STREET DUMP
REMEDIAL INVESTIGATION, CTO-0303
MCAS, NEW RIVER, NORTH CAROLINA
TCL ORGANICS

LOCATION	43-EC-SD01-6	43-EC-SD01-612	43-EC-SD02-06	43-EC-SD02-612	43-SHC-SD01-06	43-SHC-SD01-612
DATE SAMPLED	05/05/95	05/05/95	05/05/95	05/05/95	05/05/95	05/05/95
DEPTH	0-6"	6-12"	0-6"	6-12"	0-6"	6-12"
UNITS	UG/KG	UG/KG	UG/KG	UG/KG	UG/KG	UG/KG
VOLATILE						
ACETONE	140 J	110 U	46 U	63 U	12 U	10 J
CARBON DISULFIDE	20 J	110 U	46 U	26	12 U	3 J
SEMIVOLATILE						
4-METHYLPHENOL	2100 U	3700 U	1500 U	2100 U	400 U	430 U
PYRENE	2100 U	3700 U	200 J	2100 U	400 U	430 U
BIS(2-ETHYLHEXYL)PHTHALATE	890 J	500 J	920 J	310 J	280 J	540
BENZO(A)PYRENE	2100 U	1400 J	1500 U	650 J	400 U	430 U
PESTICIDE/PCBS						
4,4'-DDE	1600 J	3600 UJ	890 J	110 J	12 J	24 J
ENDRIN	16 J	36 UJ	15 R	21 UJ	4 UJ	4.3 UJ
4,4'-DDD	8500 J	1400	2200 J	160 J	5.6 J	9.8 J
4,4'-DDT	180 J	36 UJ	11 J	21 UJ	4 UJ	4.3 UJ
ALPHA-CHLORDANE	21 J	18 UJ	9.3 J	10 UJ	7.2 J	18 J
GAMMA-CHLORDANE	31 J	22 J	15 J	10 UJ	9.6 J	23 J

UG/KG - microgram per kilogram
 J - value is estimated
 U - not detected
 UJ - note detected, value is estimated

TABLE 4-13
 SEDIMENT - POSITIVE DETECTION SUMMARY
 SITE 43, AGAN STREET DUMP
 REMEDIAL INVESTIGATION, CTO-0303
 MCAS, NEW RIVER, NORTH CAROLINA
 TCL ORGANICS

LOCATION	43-SHC-SD02-06	43-SHC-SD02-612	43-SHC-SD03-06	43-SHC-SD03-612	43-SHC-SD04-06	43-SHC-SD04-612
DATE SAMPLED	05/05/95	05/05/95	05/05/95	05/05/95	05/05/95	05/05/95
DEPTH	0-6"	6-12"	0-6"	6-12"	6-12"	6-12"
UNITS	UG/KG	UG/KG	UG/KG	UG/KG	UG/KG	UG/KG
VOLATILE						
ACETONE	16 U	15 U	69 U	52 U	120 J	40 U
CARBON DISULFIDE	16 U	15 U	69 U	52 U	63 U	40 U
SEMIVOLATILE						
4-METHYLPHENOL	540 U	480 U	2200 U	210 J	2000 U	1300 U
PYRENE	540 U	480 U	2200 U	1700 U	2000 U	1300 U
BIS(2-ETHYLHEXYL)PHTHALATE	500 J	480 U	2500	1700	800 J	1300 U
BENZO(A)PYRENE	540 U	1900	2200 U	1700 U	290 J	1300 U
PESTICIDE/PCBS						
4,4'-DDE	36 J	4.9 UJ	450	1300 J	8900	55 J
ENDRIN	5.5 UJ	4.9 UJ	23 UJ	12 J	21 UJ	13 UJ
4,4'-DDD	60 J	4.9 UJ	1300	6600 J	37000	280
4,4'-DDT	9.3 J	4.9 UJ	23 UJ	13 J	65 J	16 J
ALPHA-CHLORDANE	9.3 J	2.4 UJ	41 J	49 J	10 J	6.5 UJ
GAMMA-CHLORDANE	12 J	2.4 UJ	74 J	70 J	19 J	6.5 UJ

UG/KG - microgram per kilogram
 J - value is estimated
 U - not detected
 UJ - note detected, value is estimated

TABLE 4-14
 SEDIMENT - POSITIVE DETECTION SUMMARY
 SITE 43, AGAN STREET DUMP
 REMEDIAL INVESTIGATION, CTO-0303
 MCAS, NEW RIVER, NORTH CAROLINA
 TAL METALS

LOCATION	43-EC-SD01-06	43-EC-SD01-612	43-EC-SD02-06	43-EC-SD02-612	43-SHC-SD01-06	43-SHC-SD01-612
DATE SAMPLED	05/05/95	05/05/95	05/05/95	05/05/95	05/05/95	05/05/95
DEPTH	0-6"	6-12"	0-6"	6-12"	0-6"	6-12"
UNITS	MG/KG	MG/KG	MG/KG	MG/KG	MG/KG	MG/KG
ALUMINUM, TOTAL	15700	7670	13600	9950	878	1360
ARSENIC, TOTAL	2.7 J	3.7 U	4.5 J	5.7	0.37 U	0.31 U
BARIUM, TOTAL	31.5	21	32.1	34.3	4.4	7.9
BERYLLIUM, TOTAL	0.34 U	0.52 U	0.21 U	0.34 U	0.06 U	0.07 U
CADMIUM, TOTAL	4.8	6.8 U	2.8 U	4.5 U	0.76 U	0.91 U
CALCIUM, TOTAL	7280	12300	6930	13900	2210	1880
CHROMIUM, TOTAL	27.2	9.5	20.1	8.3	3.6	4.5
COBALT, TOTAL	2.1	2.4 U	3.1	1.8	0.27 U	0.66
COPPER, TOTAL	53	5.1	38.5	11.3	0.35 U	6.2
IRON, TOTAL	20500	11100	14600	23800	963	2040
LEAD, TOTAL	180	32.5 J	107	18.1 J	49.7	32.7
MAGNESIUM, TOTAL	4370	6440	2570	3090	82.5	110
MANGANESE, TOTAL	78.5	47.2	46.7	37.5	2.7	4.6
MERCURY, TOTAL	0.66	0.79 U	0.44	0.5 U	0.12 U	0.1 U
NICKEL, TOTAL	15.5	9.4 U	9.9	6.2 U	1.1 U	1.3 U
POTASSIUM, TOTAL	1070	800	868	1660	60.3	129
SELENIUM, TOTAL	1.7 U	3.9 U	2.6	2.4	0.4 U	0.32 U
SILVER, TOTAL	2.2 U	3.3 U	2.8	2.2 U	0.37 U	0.44 U
SODIUM, TOTAL	7270	14800	5700	6160	75.6	52.7
VANADIUM, TOTAL	63.9	27.2	34.2	16.9	3.6	6.4
ZINC, TOTAL	338	117	219	53.3	45.7	48

MG/KG - milligram per kilogram

J - value is estimated

U - not detected

TABLE 4-14
 SEDIMENT - POSITIVE DETECTION SUMMARY
 SITE 43, AGAN STREET DUMP
 REMEDIAL INVESTIGATION, CTO-0303
 MCAS, NEW RIVER, NORTH CAROLINA
 TAL METALS

LOCATION	43-SHC-SD02-06	43-SHC-SD02-612	43-SHC-SD03-06	43-SHC-SD03-612	43-SHC-SD04-06	43-SHC-SD04-612
DATE SAMPLED	05/05/95	05/05/95	05/05/95	05/05/95	05/05/95	05/05/95
DEPTH	N/A	N/A	N/A	N/A	N/A	N/A
UNITS	MG/KG	MG/KG	MG/KG	MG/KG	MG/KG	MG/KG
ALUMINUM, TOTAL	1720	2620	13900	10300	16400	4370
ARSENIC, TOTAL	0.4 U	0.41 U	3.2	2.1	4 J	1.3 U
BARIUM, TOTAL	5.9	10.6	46.1	44.1	35.4	20.7
BERYLLIUM, TOTAL	0.1	0.07 U	0.4 U	0.28 U	0.36 U	0.2 U
CADMIUM, TOTAL	1.2 U	0.94 U	5.2 U	3.6 U	4.6 U	2.6 U
CALCIUM, TOTAL	1080	2100	6470	7890	9690	6520
CHROMIUM, TOTAL	1.8	2.9	19.9	14.2	18.7	4.5
COBALT, TOTAL	0.45 U	0.34 U	1.9 U	1.9	2.3	0.93 U
COPPER, TOTAL	1.7	0.43 U	29	13.1	31.6	1.2 U
IRON, TOTAL	2300	763	15100	6790	16700	5810
LEAD, TOTAL	42.5	6.1	206	99	111	7.6
MAGNESIUM, TOTAL	567	310	4100	4590	6000	3860
MANGANESE, TOTAL	5.5	3.4	52.2	25.9	52.6	11.7
MERCURY, TOTAL	0.11 U	0.13 U	0.6 U	0.38 U	0.57 U	0.26 U
NICKEL, TOTAL	1.7	1.3 U	9.5	5.9	8.3	3.6 U
POTASSIUM, TOTAL	137	101	1090	772	1340	409
SELENIUM, TOTAL	0.43 U	0.44 U	2.6	2	2 U	1.5 J
SILVER, TOTAL	0.6 U	0.46 U	2.5 U	1.9	2.3 U	1.3 U
SODIUM, TOTAL	482	197	9120	7730	9920	6500
VANADIUM, TOTAL	5.4	2.1	57.3	26.6	43.7	7.5
ZINC, TOTAL	43.9	1.5	254	92.5	223	17.3

MG/KG - milligram per kilogram

J - value is estimated

U - not detected

SECTION 4.0 FIGURES

LOCATION 43-WA-SB01A-00
DATE SAMPLED 03/14/95

SEMIVOLATILE (ug/kg)	
2-METHYLNAPHTHALENE	74 J
ACENAPHTHENE	2900
DIBENZOFURAN	870
FLUORENE	1700
PHENANTHRENE	5900 J
ANTHRACENE	820
CARBAZOLE	350 J
FLUORANTHENE	60000
PYRENE	64000
BENZO(A)ANTHRACENE	41000
CHRYSENE	46000
BENZO(B)FLUORANTHENE	52000
BENZO(K)FLUORANTHENE	20000
BENZO(A)PYRENE	39000
INDENO(1,2,3-CD)PYRENE	27000
DIBENZO(A,H)ANTHRACENE	1200
BENZO(G,H,I)PERYLENE	24000

LOCATION 43-WA-SB01A3-00
DATE SAMPLED 05/01/95

SEMIVOLATILE (ug/kg)	
ACENAPHTHYLENE	71 J
ACENAPHTHENE	63 J
DIBENZOFURAN	35 J
FLUORENE	59 J
PHENANTHRENE	1300
ANTHRACENE	210 J
CARBAZOLE	300 J
FLUORANTHENE	6400
PYRENE	6500
BUTYLBENZYLPHTHALATE	100 J
BENZO(A)ANTHRACENE	3200
CHRYSENE	4500
BENZO(B)FLUORANTHENE	6800
BENZO(K)FLUORANTHENE	1300
BENZO(A)PYRENE	4700
INDENO(1,2,3-CD)PYRENE	3600
DIBENZO(A,H)ANTHRACENE	710
BENZO(G,H,I)PERYLENE	3400

LOCATION 43-WA-SB01B-00
DATE SAMPLED 03/14/95

SEMIVOLATILE (ug/kg)	
FLUORANTHENE	130 J
PYRENE	150 J
BENZO(A)ANTHRACENE	67 J
CHRYSENE	120 J
BENZO(B)FLUORANTHENE	600
BENZO(K)FLUORANTHENE	280 J
BENZO(A)PYRENE	770
INDENO(1,2,3-CD)PYRENE	590
DIBENZO(A,H)ANTHRACENE	110 J
BENZO(G,H,I)PERYLENE	380 J

LOCATION 43-WA-SB01C-00
DATE SAMPLED 03/14/95

SEMIVOLATILE (ug/kg)	
PHENANTHRENE	54 J
FLUORANTHENE	350
PYRENE	430
BENZO(A)ANTHRACENE	260 J
CHRYSENE	340 J
BENZO(B)FLUORANTHENE	500
BENZO(K)FLUORANTHENE	200 J
BENZO(A)PYRENE	480
INDENO(1,2,3-CD)PYRENE	550
DIBENZO(A,H)ANTHRACENE	47 J
BENZO(G,H,I)PERYLENE	460

LOCATION 43-WA-SB01A1-00
DATE SAMPLED 05/01/95

SEMIVOLATILE (ug/kg)	
PHENANTHRENE	610
CARBAZOLE	120 J
FLUORANTHENE	1500
PYRENE	1200
BENZO(A)ANTHRACENE	560
CHRYSENE	890
BENZO(B)FLUORANTHENE	1100
BENZO(K)FLUORANTHENE	420
BENZO(A)PYRENE	690
INDENO(1,2,3-CD)PYRENE	590
DIBENZO(A,H)ANTHRACENE	110 J
BENZO(G,H,I)PERYLENE	560

LOCATION 43-WA-SB01A4-00
DATE SAMPLED 05/01/95

SEMIVOLATILE (ug/kg)	
PHENANTHRENE	67 J
FLUORANTHENE	230 J
PYRENE	170 J
BENZO(A)ANTHRACENE	51 J
CHRYSENE	110 J
BENZO(B)FLUORANTHENE	170 J
BENZO(K)FLUORANTHENE	57 J
BENZO(A)PYRENE	79 J
INDENO(1,2,3-CD)PYRENE	90 J
BENZO(G,H,I)PERYLENE	87 J

LOCATION 43-WA-SB01A2-00
DATE SAMPLED 05/01/95

SEMIVOLATILE (ug/kg)	
ACENAPHTHENE	45 J
FLUORENE	53 J
PHENANTHRENE	1000
CARBAZOLE	260 J
FLUORANTHENE	2200
PYRENE	2100
BUTYLBENZYLPHTHALATE	50 J
BENZO(A)ANTHRACENE	980
CHRYSENE	1500
BENZO(B)FLUORANTHENE	2300
BENZO(K)FLUORANTHENE	700
BENZO(A)PYRENE	1300
INDENO(1,2,3-CD)PYRENE	1300
DIBENZO(A,H)ANTHRACENE	280 J
BENZO(G,H,I)PERYLENE	1200

LOCATION 43-GW01DW-00
DATE SAMPLED 02/28/95

SEMIVOLATILE (ug/kg)	
PHENANTHRENE	720
ANTHRACENE	44 J
CARBAZOLE	99 J
FLUORANTHENE	1400
PYRENE	1100
BENZO(A)ANTHRACENE	570
CHRYSENE	1000
BENZO(B)FLUORANTHENE	1500
BENZO(K)FLUORANTHENE	580
BENZO(A)PYRENE	760
INDENO(1,2,3-CD)PYRENE	500
DIBENZO(A,H)ANTHRACENE	110 J
BENZO(G,H,I)PERYLENE	420

LOCATION 43-WA-SB01-00
DATE SAMPLED 02/28/95

SEMIVOLATILE (ug/kg)	
PHENANTHRENE	260 J
FLUORANTHENE	530
PYRENE	470
BENZO(A)ANTHRACENE	190 J
CHRYSENE	370 J
BENZO(B)FLUORANTHENE	410
BENZO(K)FLUORANTHENE	200 J
BENZO(A)PYRENE	260 J
INDENO(1,2,3-CD)PYRENE	270 J
DIBENZO(A,H)ANTHRACENE	73 J
BENZO(G,H,I)PERYLENE	280 J
PESTICIDE/PCBS (ug/kg)	
HEPTACHLOR EPOXIDE	2 J
4,4'-DDE	5.7 J

LOCATION 43-WA-SB03-00
DATE SAMPLED 02/28/95

SEMIVOLATILE (ug/kg)	
FLUORANTHENE	49 J
PYRENE	49 J
BENZO(B)FLUORANTHENE	44 J
INDENO(1,2,3-CD)PYRENE	42 J

LOCATION 43-MA-SB03-00
DATE SAMPLED 02/28/95

PESTICIDE/PCBS (ug/kg)	
4,4'-DDE	26
4,4'-DDT	30

LOCATION 43-OA-SB03-00
DATE SAMPLED 03/10/95

SEMIVOLATILE (ug/kg)	
BUTYLBENZYLPHTHALATE	420 J

LOCATION 43-OA-SB02-00
DATE SAMPLED 03/10/95

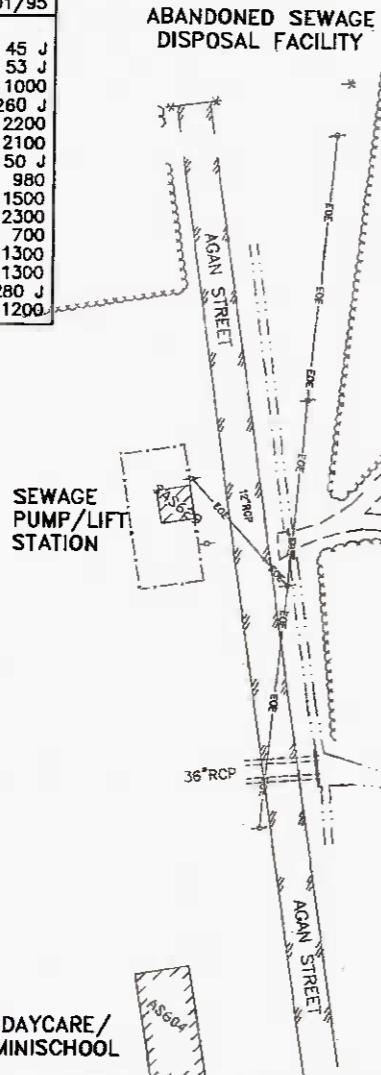
PESTICIDE/PCBS (ug/kg)	
4,4'-DDE	7.1
4,4'-DDT	10

LOCATION 43-DA1-SB02-00
DATE SAMPLED 03/10/95

SEMIVOLATILE (ug/kg)	
4-METHYLPHENOL	120 J

LOCATION 43-DA1-SB03-00
DATE SAMPLED 03/10/95

PESTICIDE/PCBS (ug/kg)	
4,4'-DDE	1000 J
4,4'-DDD	3000
4,4'-DDT	1000 J



LEGEND

- 43-GW01DW PILOT TEST BORING FOR DEEP MONITORING WELL
- OA-SB01 SOIL BORING LOCATION
- WA-SB01A SURFACE SOIL SAMPLE LOCATION
- FLOW DIRECTION OF SURFACE WATER FLOW
- MARSH
- EOE OVERHEAD ELECTRIC LINE & UTILITY POLE
- FENCE
- ASPHALT ROAD
- GRAVEL ROAD OR SOIL PATH
- EDGE OF CREEK, DRAINAGE DITCH OR MARSH
- TREE LINE
- STRUCTURE

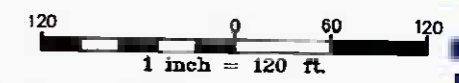
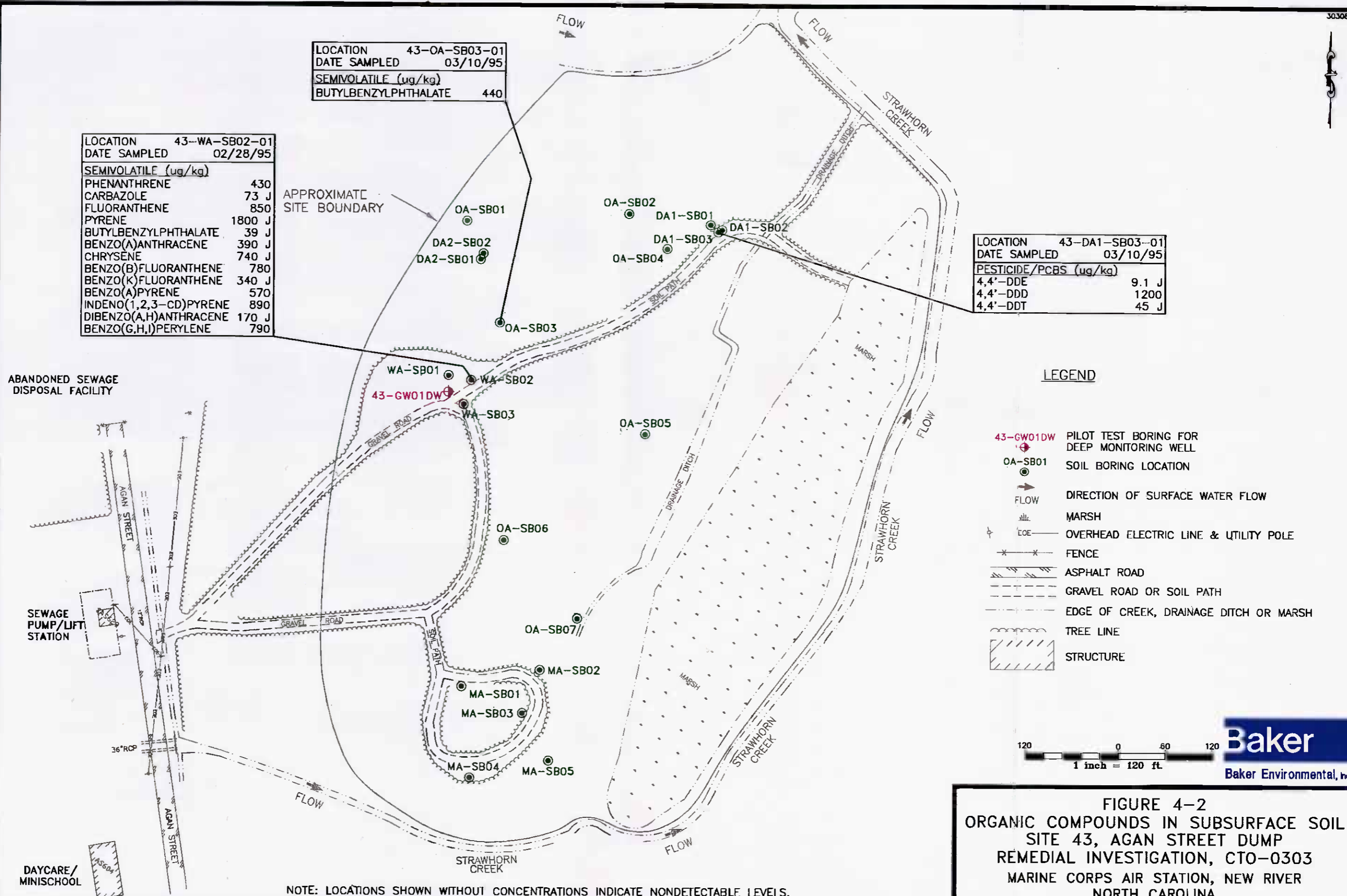


FIGURE 4-1
ORGANIC COMPOUNDS IN SURFACE SOIL
SITE 43, AGAN STREET DUMP
REMEDIAL INVESTIGATION, CTO-0303
MARINE CORPS AIR STATION, NEW RIVER
NORTH CAROLINA

NOTE: LOCATIONS SHOWN WITHOUT CONCENTRATIONS INDICATE NONDETECTABLE LEVELS.

01713Y B5Y



LOCATION	43-OA-SB03-01
DATE SAMPLED	03/10/95
SEMIVOLATILE (ug/kg)	
BUTYLBENZYLPHTHALATE	440

LOCATION	43-WA-SB02-01
DATE SAMPLED	02/28/95
SEMIVOLATILE (ug/kg)	
PHENANTHRENE	430
CARBAZOLE	73 J
FLUORANTHENE	850
PYRENE	1800 J
BUTYLBENZYLPHTHALATE	39 J
BENZO(A)ANTHRACENE	390 J
CHRYSENE	740 J
BENZO(B)FLUORANTHENE	780
BENZO(K)FLUORANTHENE	340 J
BENZO(A)PYRENE	570
INDENO(1,2,3-CD)PYRENE	890
DIBENZO(A,H)ANTHRACENE	170 J
BENZO(G,H,I)PERYLENE	790

LOCATION	43-DA1-SB03-01
DATE SAMPLED	03/10/95
PESTICIDE/PCBS (ug/kg)	
4,4'-DDE	9.1 J
4,4'-DDD	1200
4,4'-DDT	45 J

LEGEND

- 43-GW01DW PILOT TEST BORING FOR DEEP MONITORING WELL
- OA-SB01 SOIL BORING LOCATION
- FLOW DIRECTION OF SURFACE WATER FLOW
- MARSH
- EOE OVERHEAD ELECTRIC LINE & UTILITY POLE
- FENCE
- ASPHALT ROAD
- GRAVEL ROAD OR SOIL PATH
- EDGE OF CREEK, DRAINAGE DITCH OR MARSH
- TREE LINE
- STRUCTURE

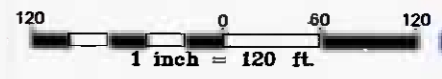
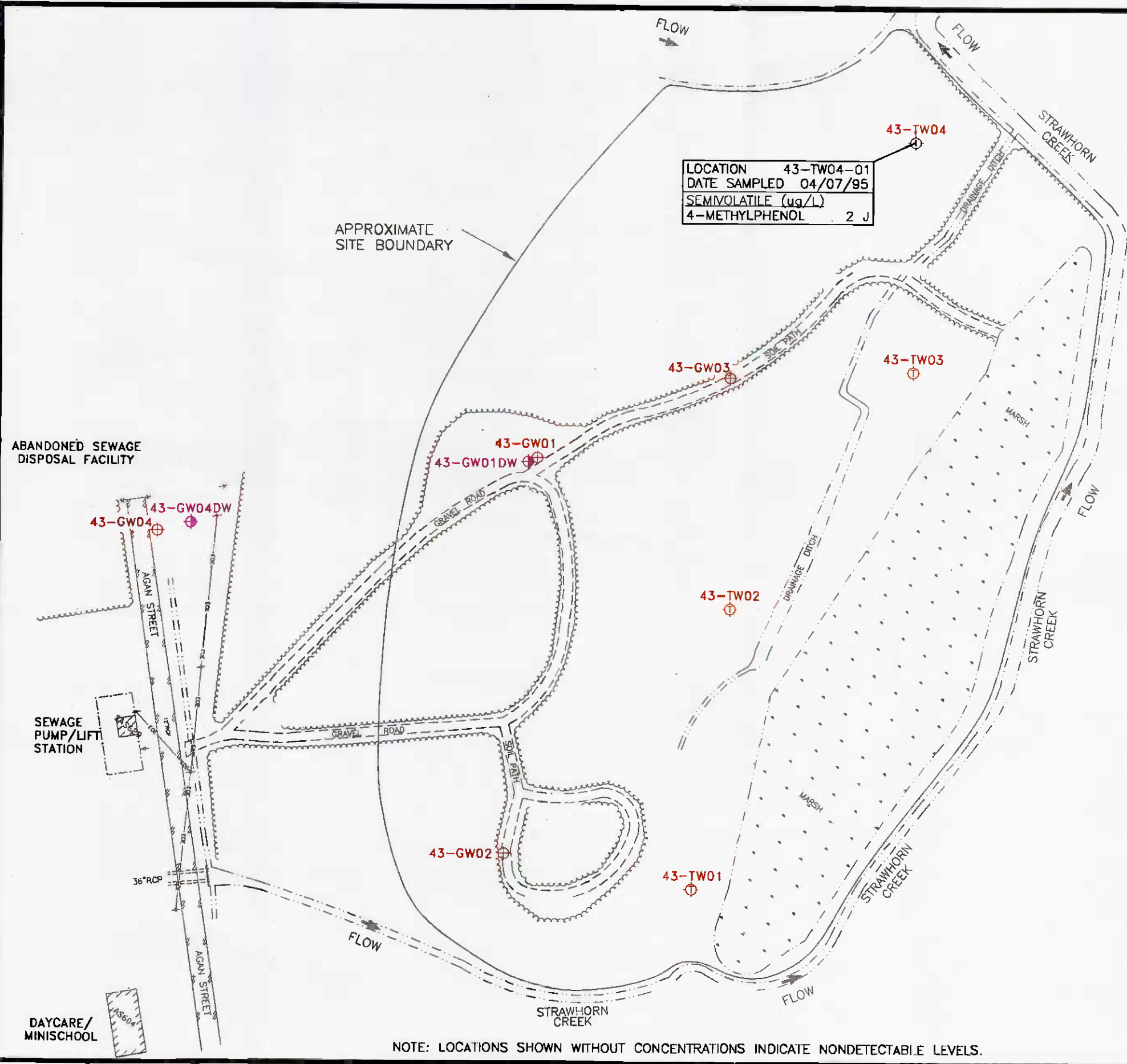


FIGURE 4-2
 ORGANIC COMPOUNDS IN SUBSURFACE SOIL
 SITE 43, AGAN STREET DUMP
 REMEDIAL INVESTIGATION, CTO-0303
 MARINE CORPS AIR STATION, NEW RIVER
 NORTH CAROLINA

NOTE: LOCATIONS SHOWN WITHOUT CONCENTRATIONS INDICATE NONDETECTABLE LEVELS.



LOCATION	43-TW04-01
DATE SAMPLED	04/07/95
SEMIVOLATILE (ug/L)	
4-METHYLPHENOL	2 J

LEGEND

- 43-GW01 SHALLOW MONITORING WELL
- 43-GW01DW DEEP MONITORING WELL
- 43-TW01 TEMPORARY MONITORING WELL
- FLOW DIRECTION OF SURFACE WATER FLOW
- MARSH
- OVERHEAD ELECTRIC LINE & UTILITY POLE
- FENCE
- ASPHALT ROAD
- GRAVEL ROAD OR SOIL PATH
- EDGE OF CREEK, DRAINAGE DITCH OR MARSH
- TREE LINE
- STRUCTURE

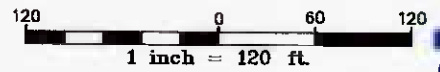
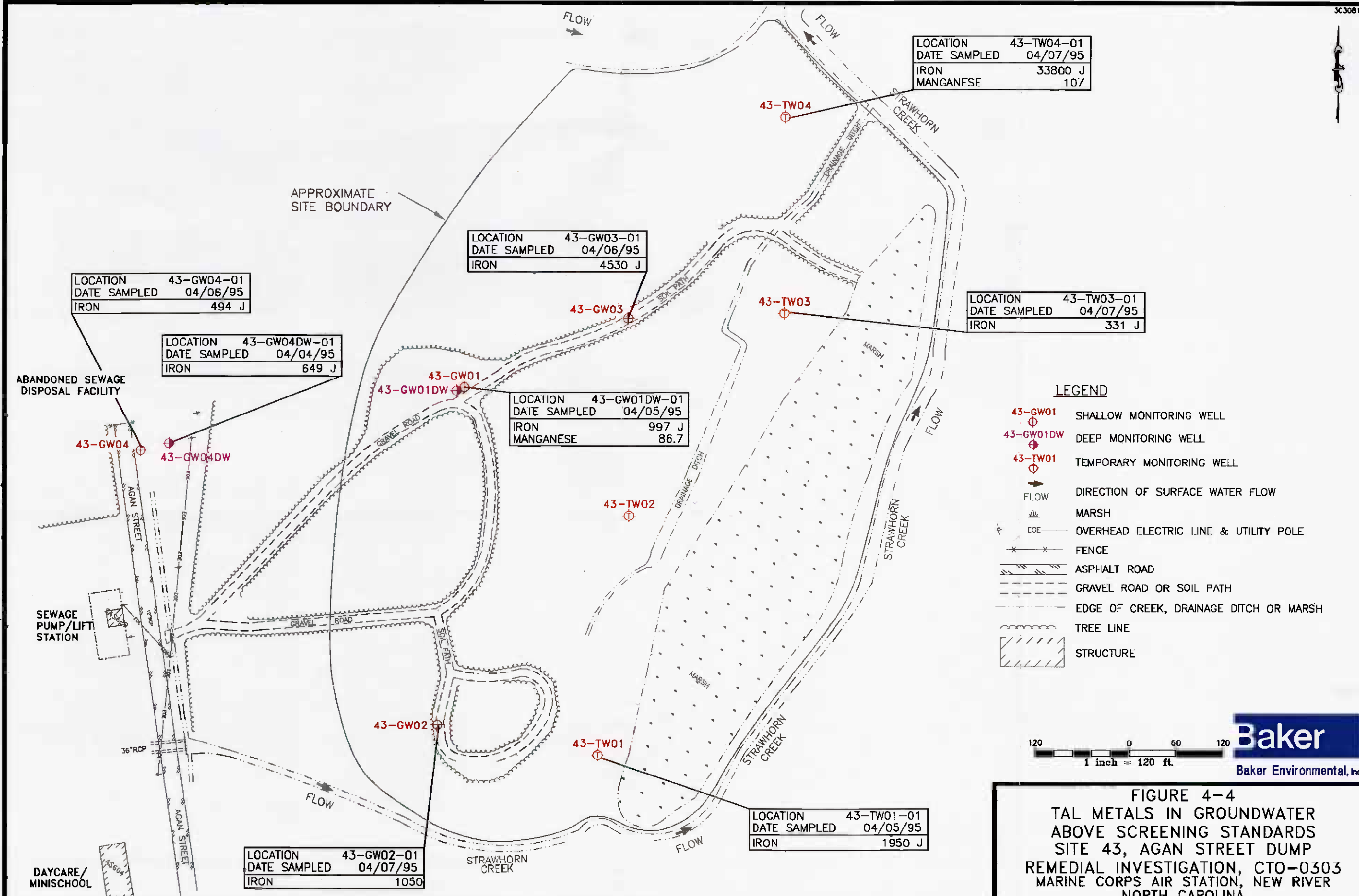


FIGURE 4-3
ORGANIC COMPOUNDS IN GROUNDWATER
SITE 43, AGAN STREET DUMP
REMEDIAL INVESTIGATION, CTO-0303
MARINE CORPS AIR STATION, NEW RIVER
NORTH CAROLINA

NOTE: LOCATIONS SHOWN WITHOUT CONCENTRATIONS INDICATE NONDETECTABLE LEVELS.



- LEGEND**
- ⊕ 43-GW01 SHALLOW MONITORING WELL
 - ⊕ 43-GW01DW DEEP MONITORING WELL
 - ⊕ 43-TW01 TEMPORARY MONITORING WELL
 - FLOW DIRECTION OF SURFACE WATER FLOW
 - ▨ MARSH
 - COE OVERHEAD ELECTRIC LINE & UTILITY POLE
 - FENCE
 - ASPHALT ROAD
 - GRAVEL ROAD OR SOIL PATH
 - EDGE OF CREEK, DRAINAGE DITCH OR MARSH
 - TREE LINE
 - ▨ STRUCTURE

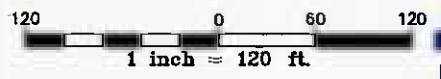


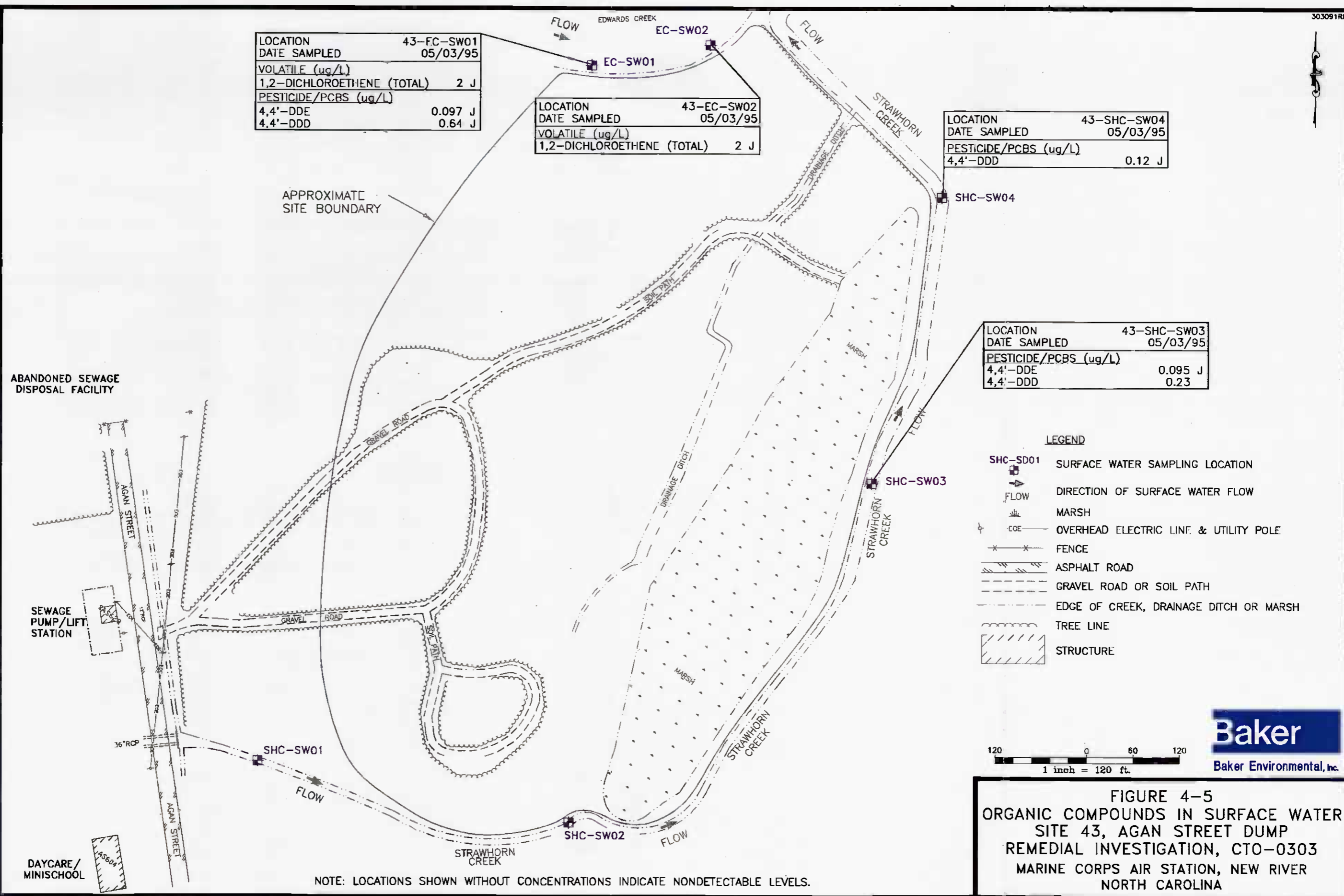
FIGURE 4-4
TAL METALS IN GROUNDWATER
ABOVE SCREENING STANDARDS
SITE 43, AGAN STREET DUMP
REMEDIAL INVESTIGATION, CTO-0303
MARINE CORPS AIR STATION, NEW RIVER
NORTH CAROLINA

LOCATION	43-FC-SW01
DATE SAMPLED	05/03/95
VOLATILE (ug/L)	
1,2-DICHLOROETHENE (TOTAL)	2 J
PESTICIDE/PCBS (ug/L)	
4,4'-DDE	0.097 J
4,4'-DDD	0.64 J

LOCATION	43-EC-SW02
DATE SAMPLED	05/03/95
VOLATILE (ug/L)	
1,2-DICHLOROETHENE (TOTAL)	2 J

LOCATION	43-SHC-SW04
DATE SAMPLED	05/03/95
PESTICIDE/PCBS (ug/L)	
4,4'-DDD	0.12 J

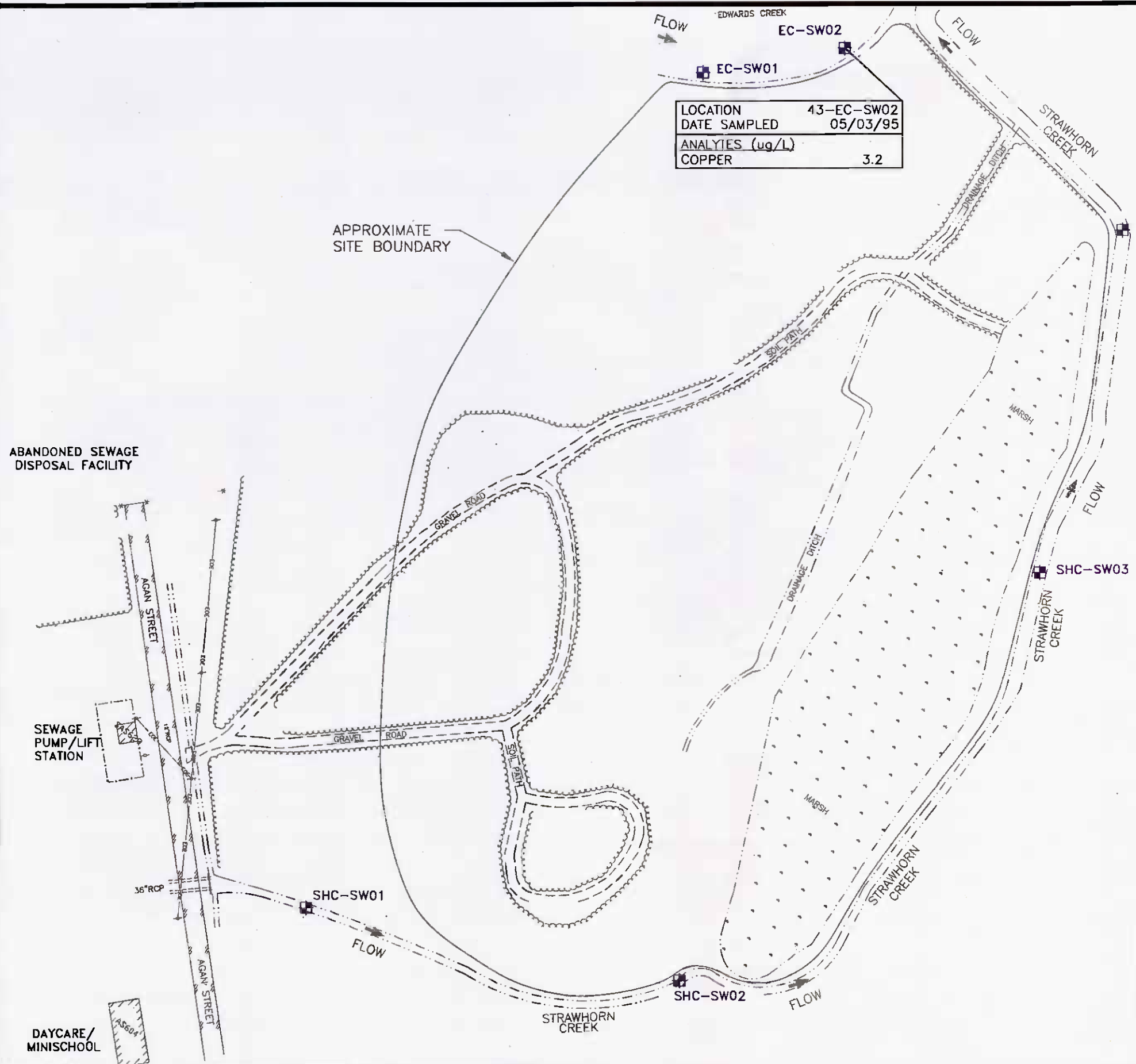
LOCATION	43-SHC-SW03
DATE SAMPLED	05/03/95
PESTICIDE/PCBS (ug/L)	
4,4'-DDE	0.095 J
4,4'-DDD	0.23



NOTE: LOCATIONS SHOWN WITHOUT CONCENTRATIONS INDICATE NONDETECTABLE LEVELS.

FIGURE 4-5
ORGANIC COMPOUNDS IN SURFACE WATER
SITE 43, AGAN STREET DUMP
REMEDIAL INVESTIGATION, CTO-0303
MARINE CORPS AIR STATION, NEW RIVER
NORTH CAROLINA





LOCATION	43-EC-SW02
DATE SAMPLED	05/03/95
ANALYTES (ug/L)	
COPPER	3.2

LEGEND

- SHC-SW01 SURFACE WATER SAMPLING LOCATION
- FLOW DIRECTION OF SURFACE WATER FLOW
- MARSH
- EOE OVERHEAD ELECTRIC LINE & UTILITY POLE
- FENCE
- ASPHALT ROAD
- GRAVEL ROAD OR SOIL PATH
- EDGE OF CREEK, DRAINAGE DITCH OR MARSH
- TREE LINE
- STRUCTURE

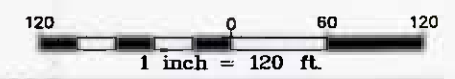
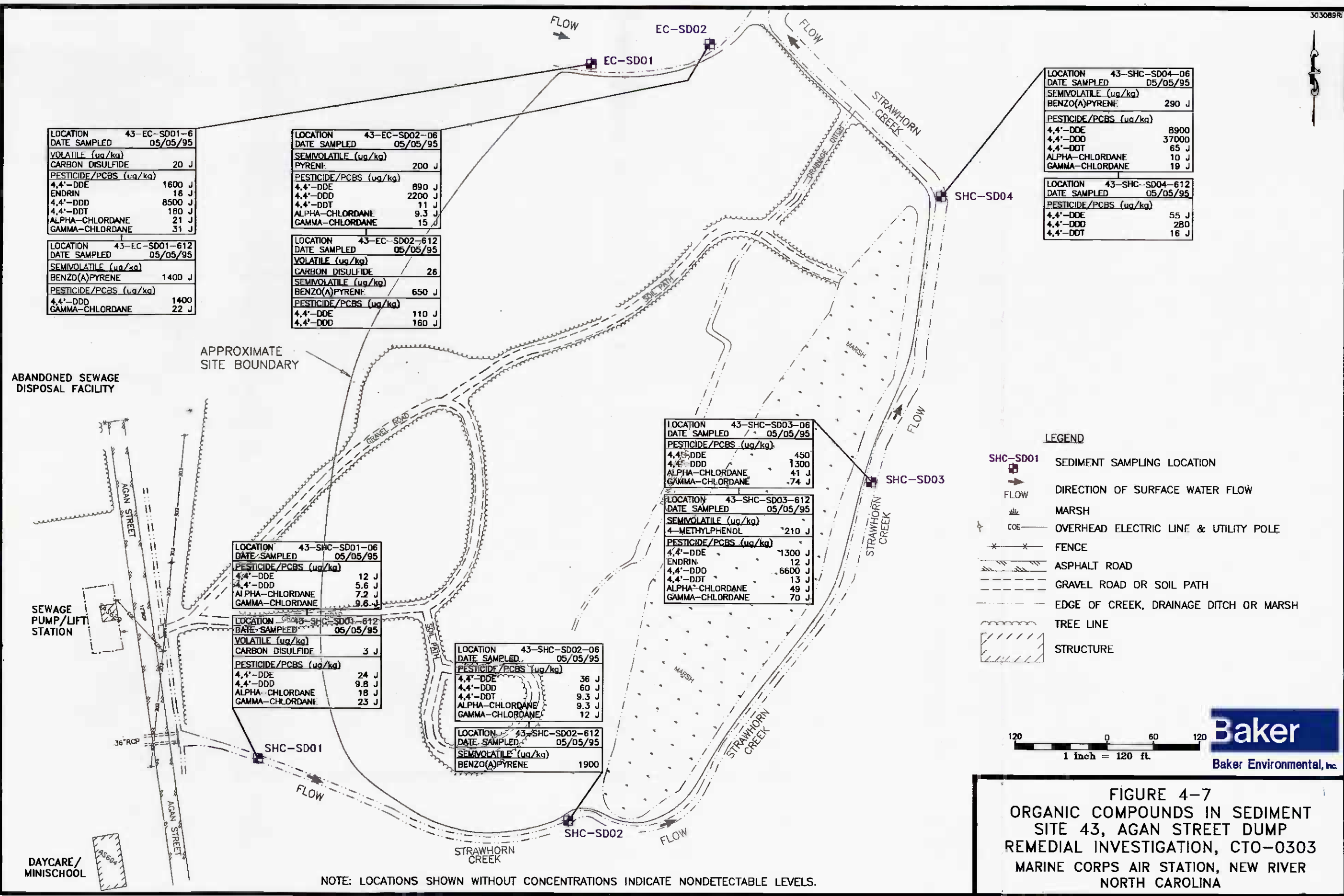


FIGURE 4-6
 TAL METALS IN SURFACE WATER
 ABOVE SCREENING VALUES
 SITE 43, AGAN STREET DUMP
 REMEDIAL INVESTIGATION, CTO-0303
 MARINE CORPS AIR STATION, NEW RIVER
 NORTH CAROLINA



LOCATION	43-EC-SD01-6
DATE SAMPLED	05/05/95
VOLATILE (ug/kg)	
CARBON DISULFIDE	20 J
PESTICIDE/PCBS (ug/kg)	
4,4'-DDE	1600 J
ENDRIN	18 J
4,4'-DDD	8500 J
4,4'-DDT	180 J
ALPHA-CHLORDANE	21 J
GAMMA-CHLORDANE	31 J

LOCATION	43-EC-SD01-612
DATE SAMPLED	05/05/95
SEMIVOLATILE (ug/kg)	
BENZO(A)PYRENE	1400 J
PESTICIDE/PCBS (ug/kg)	
4,4'-DDD	1400
GAMMA-CHLORDANE	22 J

LOCATION	43-EC-SD02-06
DATE SAMPLED	05/05/95
SEMIVOLATILE (ug/kg)	
PYRENE	200 J
PESTICIDE/PCBS (ug/kg)	
4,4'-DDE	890 J
4,4'-DDD	2200 J
4,4'-DDT	11 J
ALPHA-CHLORDANE	9.3 J
GAMMA-CHLORDANE	15 J

LOCATION	43-EC-SD02-612
DATE SAMPLED	05/05/95
VOLATILE (ug/kg)	
CARBON DISULFIDE	26
SEMIVOLATILE (ug/kg)	
BENZO(A)PYRENE	650 J
PESTICIDE/PCBS (ug/kg)	
4,4'-DDE	110 J
4,4'-DDD	160 J

LOCATION	43-SHC-SD04-06
DATE SAMPLED	05/05/95
SEMIVOLATILE (ug/kg)	
BENZO(A)PYRENE	290 J
PESTICIDE/PCBS (ug/kg)	
4,4'-DDE	8900
4,4'-DDD	37000
4,4'-DDT	65 J
ALPHA-CHLORDANE	10 J
GAMMA-CHLORDANE	19 J

LOCATION	43-SHC-SD04-612
DATE SAMPLED	05/05/95
PESTICIDE/PCBS (ug/kg)	
4,4'-DDE	55 J
4,4'-DDD	280
4,4'-DDT	16 J

LOCATION	43-SHC-SD03-06
DATE SAMPLED	05/05/95
PESTICIDE/PCBS (ug/kg)	
4,4'-DDE	450
4,4'-DDD	1300
ALPHA-CHLORDANE	41 J
GAMMA-CHLORDANE	74 J

LOCATION	43-SHC-SD03-612
DATE SAMPLED	05/05/95
SEMIVOLATILE (ug/kg)	
4-METHYLPHENOL	210 J
PESTICIDE/PCBS (ug/kg)	
4,4'-DDE	1300 J
ENDRIN	12 J
4,4'-DDD	6600 J
4,4'-DDT	13 J
ALPHA-CHLORDANE	49 J
GAMMA-CHLORDANE	70 J

LOCATION	43-SHC-SD01-06
DATE SAMPLED	05/05/95
PESTICIDE/PCBS (ug/kg)	
4,4'-DDE	12 J
4,4'-DDD	5.6 J
ALPHA-CHLORDANE	7.2 J
GAMMA-CHLORDANE	9.6 J

LOCATION	43-SHC-SD01-612
DATE SAMPLED	05/05/95
VOLATILE (ug/kg)	
CARBON DISULFIDE	3 J
PESTICIDE/PCBS (ug/kg)	
4,4'-DDE	24 J
4,4'-DDD	9.8 J
ALPHA-CHLORDANE	18 J
GAMMA-CHLORDANE	23 J

LOCATION	43-SHC-SD02-06
DATE SAMPLED	05/05/95
PESTICIDE/PCBS (ug/kg)	
4,4'-DDE	36 J
4,4'-DDD	60 J
4,4'-DDT	9.3 J
ALPHA-CHLORDANE	9.3 J
GAMMA-CHLORDANE	12 J

LOCATION	43-SHC-SD02-612
DATE SAMPLED	05/05/95
SEMIVOLATILE (ug/kg)	
BENZO(A)PYRENE	1900

LEGEND

- SHC-SD01 [Symbol] SEDIMENT SAMPLING LOCATION
- FLOW [Arrow] DIRECTION OF SURFACE WATER FLOW
- [Symbol] MARSH
- [Symbol] OVERHEAD ELECTRIC LINE & UTILITY POLE
- [Symbol] FENCE
- [Symbol] ASPHALT ROAD
- [Symbol] GRAVEL ROAD OR SOIL PATH
- [Symbol] EDGE OF CREEK, DRAINAGE DITCH OR MARSH
- [Symbol] TREE LINE
- [Symbol] STRUCTURE

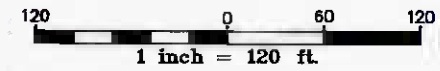


FIGURE 4-7
ORGANIC COMPOUNDS IN SEDIMENT
SITE 43, AGAN STREET DUMP
REMEDIAL INVESTIGATION, CTO-0303
MARINE CORPS AIR STATION, NEW RIVER
NORTH CAROLINA

NOTE: LOCATIONS SHOWN WITHOUT CONCENTRATIONS INDICATE NONDETECTABLE LEVELS.

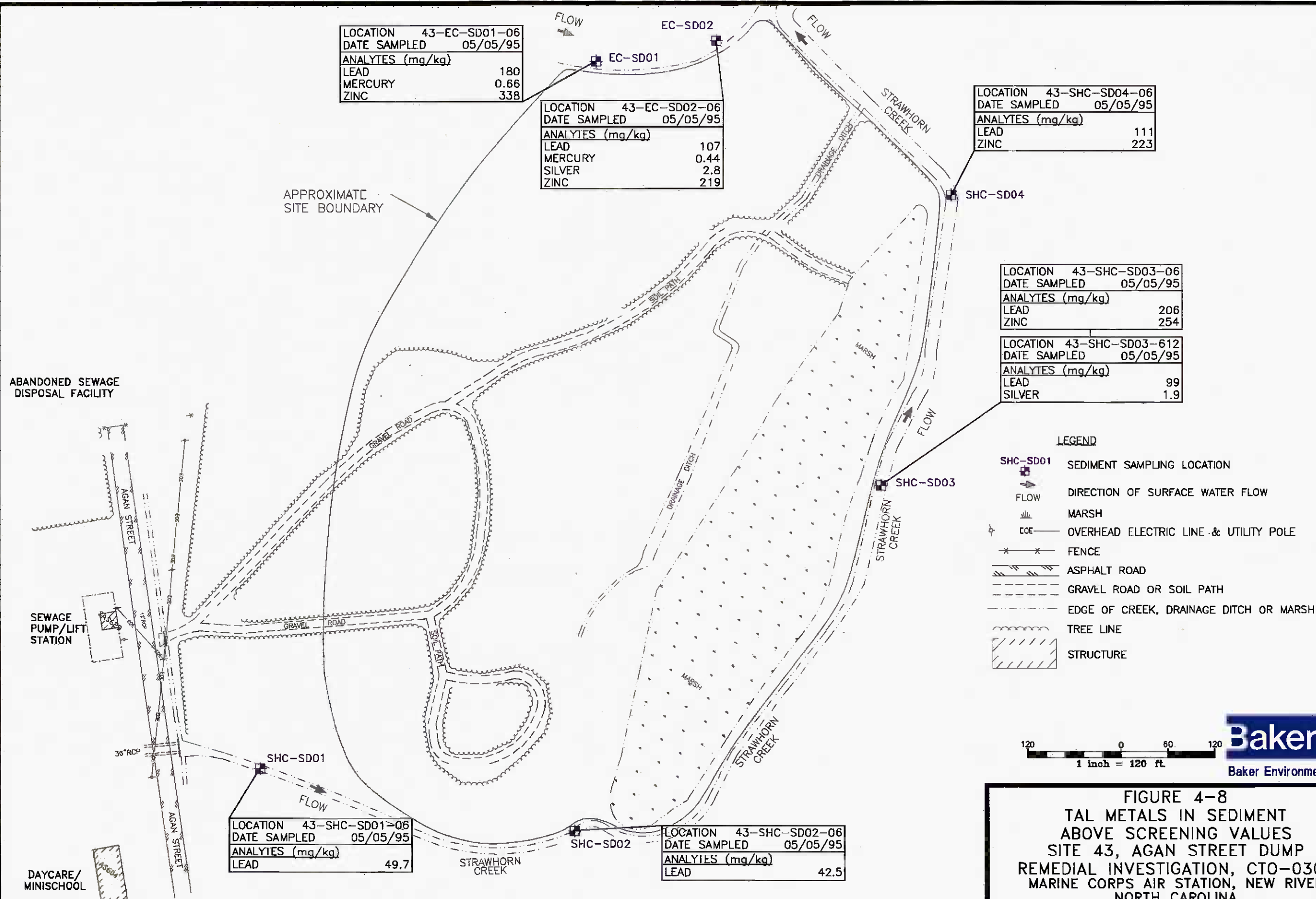


FIGURE 4-8
TAL METALS IN SEDIMENT
ABOVE SCREENING VALUES
SITE 43, AGAN STREET DUMP
REMEDIAL INVESTIGATION, CTO-0303
MARINE CORPS AIR STATION, NEW RIVER
NORTH CAROLINA

5.0 CONTAMINANT FATE AND TRANSPORT

The potential for a contaminant to migrate and persist in an environmental medium is critical when evaluating the potential for a chemical to elicit an adverse human health or ecological effect. The environmental mobility of a chemical is influenced by its physical and chemical properties, the physical characteristics of the site, and the site chemistry. This section presents a discussion of the various physical and chemical properties of significant contaminants in Site 43 media discussed in Section 4.0, and their fate and transport in the environment.

5.1 Chemical and Physical Properties Impacting Fate and Transport

Table 5-1 presents the physical and chemical properties associated with the organic compounds detected during this investigation. These properties determine the inherent environmental mobility and fate of a contaminant. The properties of interest include:

- Vapor pressure
- Water solubility
- Octanol/water partition coefficient
- Organic carbon adsorption coefficient (sediment partition)
- Specific gravity
- Henry's Law constant

A discussion of the environmental significance of each of these properties follows.

Vapor pressure provides an indication of the rate at which a chemical may volatilize. It is of primary significance at environmental interfaces such as surface soil/air and surface water/air. Volatilization can be important when evaluating groundwater and subsurface soils, particularly when selecting remedial technologies. Vapor pressure for monocyclic aromatics is generally higher than vapor pressures for PAHs. Contaminants with higher vapor pressures (e.g., VOCs) will enter the atmosphere at a quicker rate than the contaminants with low vapor pressures (e.g., PCBs).

The rate at which a contaminant is leached from soil by infiltrating precipitation is proportional to its water solubility. More soluble contaminants are usually more readily leached than less soluble contaminants. The water solubilities indicate that the volatile organic contaminants, including monocyclic aromatics, are usually several orders-of-magnitude more soluble than PAHs. Consequently, highly soluble compounds such as the chlorinated VOCs will go into solution faster and possibly in greater concentrations than less soluble compounds. The solubility of a specific compound is dependent on the chemistry of the groundwater and aquifer material. Factors such as groundwater pH, Eh (redox potential), temperature, and the presence of other compounds can affect solubility.

The octanol/water partition coefficient (K_{ow}) is the ratio of the chemical concentration in octanol divided by the concentration in water. The octanol/water partition coefficient has been shown to correlate well with bioconcentration factors in aquatic organisms and adsorption to soil or sediment. Specifically, a linear relationship between octanol/water partition coefficients and the uptake of chemicals by fatty tissues of animal and human receptors (the bioconcentration factor - BCF) has been established (Lyman et al., 1982). The coefficient is also useful in characterizing the sorption of compounds by organic soils where experimental values are not available.

The organic carbon adsorption coefficient (K_{oc}) indicates the tendency of a chemical to adhere to the organic carbon in soil particles. The solubility of a chemical in water is inversely proportional to the K_{oc} . Contaminants with high soil/sediment adsorption coefficients generally have low water solubilities. For example, contaminants such as PAHs are relatively immobile in the environment, are preferentially bound to the soil, and therefore have a higher K_{oc} value. These compounds are not subject to aqueous transport to the extent of compounds with higher water solubilities. Mechanical activities (e.g., erosion) and the physical characteristics of surface soils may, however, increase the mobility of these bound soil contaminants.

Specific gravity is the ratio of a given volume of pure chemical at a specified temperature to the weight of the same volume of water at a given temperature. Its primary use is to determine whether a contaminant will have a tendency to "float" or "sink" (as an immiscible liquid) in water if it exceeds its corresponding water solubility.

Vapor pressure and water solubility are of use in determining volatilization rates from surface water bodies and from groundwater. These two parameters can be used to estimate an equilibrium concentration of a contaminant in the water phase and in the air directly above the water. This relationship is expressed as Henry's Law Constant.

A quantitative assessment of mobility has been developed that uses water solubility (S), vapor pressure (VP), and organic carbon partition coefficient (K_{oc}) (Laskowski, 1983). This value is referred to as the Mobility Index (MI). It is defined as:

$$MI = \log((S*VP)/K_{oc})$$

A scale to evaluate MI as presented by Ford and Gurba (1984) is:

<u>Relative MI</u>	<u>Mobility Description</u>
> 5	extremely mobile
0 to 5	very mobile
-5 to 0	slightly mobile
-10 to -5	immobile
< -10	very immobile

The mobility index for each organic analyte detected at Site 43 is presented on Table 5-1.

5.2 Contaminant Transport Pathways

Based on the evaluation of existing conditions at Site 43, the following potential contaminant transport pathways have been identified.

- Windblown dust
- Leaching of sediment contaminants to surface water
- Migration of contaminants in surface water
- Leaching of soil contaminants to groundwater

Contaminant concentrations may be affected by one or more mechanisms during transport. Contaminants may be physically transformed by volatilization or precipitation. Contaminants may

be chemically transformed through photolysis, hydrolysis, oxidation/reduction. Contaminants may be biologically transformed by biodegradation. Additionally, contaminants may accumulate in one or more media. Because different transformation mechanisms are important for different contaminants, mechanisms are discussed as necessary in Section 5.3.

The paragraphs which follow describe the potential transport pathways listed above with respect to significant compound concentrations. Significant compound concentrations refer to those compounds discussed in Section 4.0 frequently occurring above criteria comparisons. Specific fate and transport concerns are discussed in Section 5.3.

5.2.1 Windblown Dust

Wind serves as a contaminant transport pathway agent by eroding exposed soil and exposed sediment. This effect is influenced by wind velocity, the grain size and density of the soil/sediment particles, moisture conditions, and the amount of vegetative cover over the soil/sediment.

A majority of the surface area of Site 43 is vegetated. This vegetation reduces the likelihood of fugitive dust generation.

5.2.2 Leaching of Sediment Contaminants to Surface Water

At Site 43, there are two surface water bodies of concern, Strawhorn Creek and Edwards Creek. Pesticides, PAHs, and heavy metals were detected in a limited number of sediment samples collected from both streams (Figures 4-5 through 4-8).

When in contact with surface water, contaminants attached to sediment particles can disassociate from the particle into surface water. This is primarily influenced by the physical and chemical properties of the contaminant (i.e., water solubility, K_{oc}) and the physical and chemical properties of the sediment particle (i.e., grain size, f_{oc}).

5.2.3 Migration of Contaminants in Surface Water

Low concentrations of volatile organics, pesticides, PAH and heavy metals were detected in a limited number of surface water samples from Edwards Creek and Strawhorn Creek (Figures 4-5 and 4-6).

Releases of VOCs to streams are expected to rapidly volatilize to the atmosphere as a result of high vapor pressures (USHHS, 1991). The portion of a release not evaporating, may dissolve into surface waters as a result of high water solubilities. For larger releases, evaporation may not be a significant pathway. Additionally, pools of immiscible product may form on the bottom of the surface water body (USHHS, 1991). VOCs tend to have low K_{oc} values and will not readily absorb to sediments with low organic content. Once released to a stream, VOC solute and immiscible liquid transport will be dependent on stream flow conditions.

A considerable fraction of the pesticides, PAHs, and heavy metals in water is associated with suspended particles. The extent of this association varies greatly with the compound, the properties of the particles, and the type of water. Contaminants in surface water carried on particles of different types will settle in areas of active sedimentation and will be deposited in the sediments.

The metals may be released again through microbial activity and changes in various physical and chemical factors, including pH and Eh.

5.2.4 Leaching of Soil Contaminants to Groundwater

The contaminants present in soil samples at Site 43 are primarily pesticides and PAHs (Figures 4-1 and 4-2). PAHs and pesticides were not detected in groundwater samples. Several heavy metals were also detected in soil samples. The ability of metals to leach from soil to groundwater is strongly dependent on geochemical conditions. Of the metals detected in soils, only iron and manganese are present in groundwater at significant levels.

Contaminants that adhere to soil particles or have accumulated in soil pore spaces can leach and migrate vertically to the groundwater as a result of infiltration of precipitation. The rate and extent of leaching is influenced by the depth to the water table, amount of precipitation, rate of infiltration, the physical and chemical properties of the soil and contaminant.

5.3 Fate and Transport Summary

The paragraphs which follow summarize the site-specific fate and transport data for contaminants detected in media collected at Site 43. Analysis of the analytical data with respect to hydrogeologic conditions does not reveal any pattern or trend to suggest that identified contaminants are migrating from Site 43 to the surrounding environment.

5.3.1 Volatile Organic Compounds (VOCs)

One VOC, 1,2-dichloroethane, was detected in two surface water samples collected from Edwards Creek. One VOC, carbon disulfide, was detected in three sediment samples from Edwards Creek and Strawhorn Creek. VOCs were not detected in surface or subsurface soils, or groundwater samples.

The presence of 1,2-dichloroethane in surface water samples may be related to an off-site source, given that 1,2-dichloroethane or parent compounds, were not detected in soil, sediment or groundwater samples from Site 43. The presence of carbon disulfide in sediment samples may be related to an off-site source, given that it was not detected in soil, surface water, or groundwater samples from Site 43.

5.3.2 Semivolatile Organic Compounds (SVOCs)

The SVOCs detected are primarily PAH compounds. PAH contamination in soil was encountered primarily in the "Well Area" (Figures 4-1 and 4-2). Low water solubilities, high K_{ow} and K_{oc} values indicate a strong tendency for PAHs to adsorb to soils, and remain immobile. PAHs have not been detected in groundwater samples collected from Site 43.

The PAH compound benzo(a)pyrene was detected in a limited number of sediment samples. This compound appears to be unrelated to the site for two reasons. The first reason is distance. PAH contamination in soil was generally limited to the "Well Area", which is more than 200 feet from both creeks. The second reason is the lack of contaminant transport pathways. Heavy vegetation minimizes fugitive dust emissions. PAHs do not appear in groundwater and therefore are not migrating via groundwater to the streams.

5.3.3 Pesticides

Pesticides have been detected in surface and subsurface soils at several locations scattered throughout Site 43. Pesticides have also been detected in several sediment samples in Strawhorn and Edwards Creeks. The pattern of distribution and concentration suggests routine application for insect control rather than product disposal may be the source of pesticide contamination. Table 5-1 shows that pesticides are immobile, mainly due to their affinity for soil surfaces. Pesticides likely have migrated to stream sediment possibly through soil erosion and/or direct deposition from pesticide application at mosquito breeding areas. Pesticides will likely continue to accumulate in sediment as erosion of soils continues. Routine pesticide application is no longer practiced. Therefore, the rate of accumulation should diminish with time due to the diminishing availability of pesticides.

5.3.4 Metals

The dissolution of heavy metals (i.e., metals having a molecular weight greater than that of sodium) from sediment to surface water or soils to groundwater has not resulted in concentrations exceeding Federal MCLs, state drinking water standards or other ARARs. Eight metals, not including iron, were observed in soil samples collected throughout Site 43 at levels exceeding base-specific background. However, only iron and manganese occur in groundwater samples exceeding ARARs. Lead and zinc were detected in all sediment samples, and mercury and silver were detected in two sediment samples. However, none of these metals was detected in surface water above ARARs.

Iron and manganese have occurred frequently in groundwater above Federal MCLs and state drinking water standards. The paragraphs which follow discuss the occurrence of these metals in groundwater. Table 5-2 presents the relative mobilities of metals as a function of environmental conditions.

Iron and manganese were detected in all groundwater samples from Site 43 and are ubiquitous in all media at MCB, Camp Lejeune. These compounds often exceed ARARs and can be contaminants-of-potential-concern for human health and/or ecological risk assessments. Previous studies at Camp Lejeune show that concentrations of iron and manganese are variable and can occur in sediments, surface water, and groundwater at levels exceeding ARARs. It is possible that elevated levels of iron and manganese in a particular media may not be associated with waste disposal, but rather be representative of natural conditions.

In a study of trace elements in a coastal plain estuary (Cross et.al., 1970), iron, manganese, and zinc were found in sediments, surface water, and worm tissue. The study was conducted over a two year period in a river estuary near Morehead City, North Carolina (approximately 40 miles northeast of Camp Lejeune). Multiple samples of surface water, sediment, and worms were collected monthly. Analysis was performed on an extract of the sediments. This study found that iron and manganese levels varied temporally. Levels decreased in samples collected at or near the Atlantic Ocean. The highest concentrations of iron, manganese, and zinc occurred inland, in a station in the Newport River. At this station, the mean levels of iron in sediment extract were reported to range from 380 µg/L to 1,800 µg/L, while manganese ranged from 12 µg/L to 71 µg/L. Median level of iron in surface water was 300 µg/L, while manganese was 22 µg/L. The study found that iron was most abundant, followed by manganese.

According to a study of chemical characteristics of natural waters (Hem, 1992), iron and manganese can occur in water through natural effects. Hem cited a report that observed manganese at 1.0 mg/L in small streams due to low dissolved oxygen levels. Hem also reported that manganese can occur in groundwater above 1.0 mg/L. Manganese can dissolve into groundwater from manganese oxide coatings on soil/sediment particles. Manganese is a significant constituent of many igneous and metamorphic rocks. Small amounts of manganese are commonly present in limestone and dolomite, substituting for calcium. Partially cemented limestone and calcareous sediments are common in the Camp Lejeune area, and were observed at Site 43.

Hem observed iron in surface water at 1.4 mg/L due to organic complexing. Typically, iron concentrations in surface water is on the order of 10 µg/L. Iron can occur in groundwater at levels as high as 50 mg/L given certain chemical conditions (a pH between 6 and 8 SU and a bicarbonate activity less than 61 mg/L). A high level of dissolved iron can occur with oxidation of ferrous sulfides. Sulfur is altered to sulfate releasing ferrous iron. Metallic sulfides are common in sedimentary and igneous rocks, or soils/sediments with those source rocks. Hem reported, "The availability of iron for aqueous solutions is strikingly affected by environmental conditions, especially changes in degree or intensity of oxidation or reduction."

Iron and manganese were detected at significant levels only in groundwater at Site 43. The median concentration of iron and manganese in groundwater samples is 17 mg/L and 0.06 mg/L, respectively. These concentrations appear within natural conditions described by Hem.

5.4 References

Cross, Ford A., Duke, Thomas W., and James N. Willis. 1970. "Biogeochemistry of Trace Elements in a Coastal Plain Estuary: Distribution of Manganese, Iron, and Zinc in Sediments, Water, and Polychaetous Worms." Chesapeake Science. Vol. 11, No. 4, 221-234. December 1970.

Environmental Science and Engineering, Incorporated (ESE). 1988. Characterization Step Report for Hadnot Point Industrial Area. Marine Corps Base, Camp Lejeune, North Carolina. Prepared for the Department of the Navy, Naval Facilities Engineering Command, Atlantic Division, Norfolk, Virginia. ESE Project No. 49-02036-0150.

Feenstra S., Cherry, J.A., and B.L. Parker. 1995. Dense Chlorinated Solvents in Groundwater: Background History of the Problem. July 1995.

Fetter, C.W. 1986. Applied Hydrogeology. Charles E. Merrill Publishing Co., Columbus, Ohio.

Ford and Gruba. 1984. Methods of Determining Relative Contaminant Mobilities and Migration Pathways Using Physical-Chemical Data.

Hem. 1992. Study of Interpretation of the Chemical Characteristics of Natural Waters. USGS Water-Supply Paper 22254.

Howard, Philip H. 1989. Handbook of Environmental Fate and Exposure Data for Organic Chemicals - Pesticides. Lewis Publishers. Chelsea, Michigan.

Howard, Philip H. 1990. Handbook of Environmental Fate and Exposure Data for Organic Chemicals - Large Production and Priority Pollutants. Lewis Publishers. Chelsea, Michigan.

Howard, Philip H. 1991. Handbook of Environmental Fate and Exposure Data for Organic Chemicals - Solvents. Lewis Publishers. Chelsea, Michigan.

Laskowski, D.A., Goring, C.A., McCall, P.J., and R.L. Swann. 1983. "Terrestrial Environment in Environmental Risk Analysis for Chemicals." Environmental Risk Analysis for Chemicals. R.A. Conways, ed., Van Nostrand Reinhold Company, New York, New York.

Lyman, W.J., Rechl, W.F., and D.H. Rosenblatt. 1982. Handbook of Chemical Property Estimation Methods. McGraw-Hill, Inc., New York.

Montgomery, J.H. and L.M. Welkon. 1990. Groundwater Chemicals Desk Reference. Lewis Publishers, Inc. Chelsea, Michigan.

Nichols. 1993. Principle of Subsurface Contaminant Fate and Transport Modeling. (Seminar)

Sax N. and R. Lewis. 1987. Hawley's Condensed Chemical Dictionary. Van Norstrand Reinhold, New York.

Superfund Chemical Data Matrix (SCDM). 1991. United States Environmental Protection Agency Hazardous Site Evaluation Division. December 1991.

Swartbaugh, et al. "Remediating Sites Contaminated with Heavy Metals." Hazardous Materials Control. November/December 1992.

United States Department of Human and Health Services (USHHS). 1991 Toxicological Profile for Trichloroethene. U.S. Department of Human and Health Services.

United States Department of Human and Health Services (USHHS). 1990 Toxicological Profile for 1,2-Dichloroethene. U.S. Department of Human and Health Services.

Verscheuren, K. 1983. Handbook of Environmental Data on Organic Chemicals. Van Nostrand Reinhold Company, New York, New York.

SECTION 5.0 TABLES

TABLE 5-1

**ORGANIC PHYSICAL AND CHEMICAL PROPERTIES
SITE 43, AGAN STREET DUMP
REMEDIAL INVESTIGATION, CTO-0303
MCB, CAMP LEJEUNE, NORTH CAROLINA**

Contaminants of Potential Concern	Vapor Pressure (mm Hg)	Water Solubility (mg/L)	Log K _{ow}	Log K _{oc}	Specific Gravity (g/cm ³)	Henry's Law Constant (atm-m ³ /mole)	Mobility Index	Comments
VOLATILES								
Acetone	270	1.00E+06	-0.24	0.34	NA	2.06E-05	8.1	Extremely Mobile
Carbon Disulfide	360	2940	2	54	1.263	1.23E-02	3.9	Very Mobile
1,2-Dichloroethene	200	600	1.48	2.26	1.22	1.90E-01	3.00	Very Mobile
SEMIVOLATILES								
4-Methylphenol	NA	NA	NA	NA	NA	NA	NA	NA
Benzo(a)anthracene	5.0E-09	0.014	5.61	5.34	NA	1.00E-06	-15.50	Very Immobile
Benzo(a)pyrene	5.0E-09	0.0038	6.04	5.72	NA	4.90E-07	-16.40	Very Immobile
Benzo(b)fluoranthene	1E-06 to 1E-07	0.009	6.57	6.26	NA	1.22E-06	-14.00	Very Immobile
Benzo(k)fluoranthene	9.6E-11	0.0016	6.84	6.22	NA	3.87E-05	-19.00	Very Immobile
Dibenzo(a,h)anthracene	1.0E-10	5E-04	6.8	3.3E+06	NA	7.33E-08	-22.1	Very Immobile
Indeno(1,2,3-cd)pyrene	1.0E-10	5.3E-04	6.51	6.20	1.070	6.95E-08	-19.50	Very Immobile
Pyrene	6.85	0.14	5.32	4.91	NA	5.10E-06	-11.90	Very Immobile
PESTICIDES								
4,4'-DDD	1.0E-06	0.09	5.99	4.47	NA	2.20E-08	-12.00	Very Immobile
4,4'-DDE	6.5E-06	0.04	4.28	3.66	NA	6.80E-05	-10.00	Immobile
4,4'-DDT	1.9E-07	0.0034	6.19	4.89	NA	1.58E-05	-14.00	Very Immobile
Endrin	3.0E-06	2.5E-04	4.56	NA	NA	7.52E-06	-	NA
alpha-Chlordane	4.6E-04	1.0E-01	5.54	NA	NA	4.85E-05	NA	NA
gamma-Chlordane	4.6E-04	1.0E-01	5.54	NA	NA	4.85E-05	NA	NA

Notes:

NA = Not Available

References:

Howard, 1989-1991
Montgomery, 1990

Sax and Lewis, 1987
SCDM, 1991
USEPA, 1986

USEPA, 1986a
Verscheuren, 1983

TABLE 5-2

RELATIVE MOBILITIES OF METALS AS A FUNCTION OF ENVIRONMENTAL CONDITIONS (Eh, pH)
 SITE 43, AGAN STREET DUMP
 REMEDIAL INVESTIGATION, CTO-0303
 MCB, CAMP LEJEUNE, NORTH CAROLINA

Relative Mobility	Environmental Conditions			
	Oxidizing	Acidic	Neutral/ Alkaline	Reducing
Very high			Se	
High	Se, Zn	Se, Zn, Cu, Ni, Hg, Ag		
Medium	Cu, Ni, Hg, Ag, As, Cd	As, Cd	As, Cd	
Low	Pb, Ba, Se	Pb, Ba, Be	Pb, Ba, Be	
Very Low	Fe, Cr	Cr	Cr, Zn, Cu, Ni, Hg, Ag	Cr, Se, Zn, Cu, Ni, Hg, Pb, Ba, Be, Ag

Notes:

Se = Selenium	Cd = Cadmium
Zn = Zinc	Ba = Barium
Cu = Copper	Pb = Lead
Ni = Nickel	Fe = Iron
Hg = Mercury	Cr = Chromium
Ag = Silver	Be = Beryllium
As = Arsenic	Zn = Zinc

Source: Swartzbaugh, et al. "Remediating Sites Contaminated with Heavy Metals."
 Hazardous Materials Control, November/December 1992.

6.0 BASELINE HUMAN HEALTH RISK ASSESSMENT

The following subsections present the baseline human health risk assessment (BRA) conducted for Site 43, Agan Street Dump. This assessment was performed in accordance with the USEPA document Risk Assessment Guidance for Superfund, Human Health Evaluation Manual: Part A (USEPA, 1989). The purpose of the BRA is to assess whether the contaminants of potential concern (COPCs) at the site pose a current or future risk to human health in the absence of remedial action. COPCs are site-related contaminants used to quantitatively estimate human exposures and associated potential health effects. Because the purpose of the risk assessment is to estimate the degree of risk to human health and to be protective of human health, the approach of the USEPA guidance is designed to be conservative. This protectiveness is achieved by the use of assumptions and models that result in upper bound estimates of risk, i.e., the true or actual risk is expected to fall between the estimated value and zero. As a result, the actual site risks are unlikely to exceed the estimated upper bound values and are probably lower than these values. The following paragraphs present a brief overview of the risk assessment process and how the assessment affects further activity at the sites.

For the BRA, both current and future land use exposure scenarios were assumed for the site. The current scenario reflects potential human exposure pathways to the COPCs that presently exist at the site (i.e., exposure pathways currently available). Likewise, the future use scenario represents exposure pathways that are conceivable in the future (e.g., residential development). The future use is typically determined by zoning and the environmental setting of the site. The development of current and future use exposure scenarios is consistent with the methodology for baseline risk assessment, as specified by USEPA.

The National Contingency Plan (NCP) stipulates a range of acceptable cancer risk levels of 1×10^{-4} to 1×10^{-6} for total risk at a hazardous waste site (USEPA, 1990). These cancer risk levels represent the probability of an individual developing cancer over his or her lifetime if exposed to the COPCs at the site. For example, a risk level of 1×10^{-6} is the probability that one person in 1,000,000 exposed persons will develop cancer in a lifetime. The total noncarcinogenic acceptable risk level is a hazard index of less than or equal to 1.0. This noncancer risk level depicts a level at or below which adverse systemic effects are not expected in the exposed population.

A remedial action is recommended when either the total cancer or noncancer risks are above the criteria established by the NCP. Some form of remedial action also is necessary when either the current or future exposure point concentrations at the site are above the applicable or suitable analogous standards (e.g., maximum contaminant levels [MCLs] for drinking water) for those COPCs for which standards exist. When a remedial action is necessary, applicable or relevant and appropriate requirements (ARARs) and/or risk-based cleanup levels are used in determining acceptable concentrations in the environmental media. No remedial response is required when the cancer and noncancer criteria and the ARARs are not exceeded.

6.1 Introduction

The BRA investigates the potential for COPCs to affect human health and/or the environment, both now and in the future, under a "no further remedial action scenario." The BRA process evaluates the data generated during the sampling and analytical phase of the RI, identifying areas of interest and COPCs with respect to geographical, demographic, and physical and biological characteristics of the study area. These, combined with the current understanding of physical and chemical

properties of the site-associated constituents (with respect to environmental fate and transport processes), are then used to estimate the concentrations of contaminants at the end points of logical exposure pathways. Finally, contaminant intakes by hypothetical receptors are determined and combined with the toxicological properties of the contaminants to estimate (inferentially) the potential public health impacts posed by constituents detected at the site.

The BRA for the site was conducted in accordance with current USEPA Risk Assessment Guidance (USEPA, 1989 and USEPA, 1991), and USEPA Region IV Supplemental Risk Guidance (USEPA, 1992d).

The components of the BRA include the following:

- Hazard Identification: determination as to whether a substance has the potential to elicit an adverse effect (toxicity) upon exposure to humans
- Exposure Assessment: identification of the human population(s) likely to be exposed and the development of specific exposure pathways for the population
- Toxicity Assessment: quantification of the relationship between the human exposure and the probability of occurrence (risk) of a toxic response
- Risk Characterization: development of a quantitative estimation of the potential risk from a combination of information collected during the exposure and toxicity assessment
- Uncertainty Analysis: identification and qualitative discussion of any major sources of uncertainty pertaining to the finding of the BRA
- Conclusions: summarization and conclusion of the results of the BRA relating to the total site risk are drawn

Each of these components of the BRA is discussed and addressed for the site. Introductory text is presented first, followed by a site-specific discussion. Referenced tables and figures are presented after the text portion of this section.

6.2 Hazard Identification

Data generated during the remedial investigation and previous studies at the site were used to draw conclusions and to identify data gaps in the BRA. The data were evaluated to assess which data were of sufficient quality to include in the risk assessment. The objective when selecting data to include in the risk assessment was to provide accurate and precise data to characterize contamination and evaluate exposure pathways.

6.2.1 Data Evaluation and Reduction

The initial hazard identification step entailed the validation and evaluation of the site data to determine its usability in the risk assessment. This process resulted in the identification of COPCs for the site. During this validation and evaluation, data that would result in inaccurate conclusions (e.g., data that were rejected or attributed to blank contamination, as qualified by the validator) were

reduced within the data set. Data reduction entailed the removal of unreliable data from the original data set based on the guidelines established by USEPA. A summary of the data quality was presented in Section 5.0.

6.2.2 Identification of Data Suitable for Use in a Quantitative Risk Assessment

To provide for accurate conclusions to be drawn from sampling results, analytical data were reviewed and evaluated. During this review and evaluation, data that would lead to inaccurate conclusions were reduced within each data set. This section presents the criteria that were used to review, reduce, and summarize the analytical data. These criteria are consistent with USEPA guidance for data reduction.

Five environmental media were investigated at the site during this RI: surface soils, subsurface soils, groundwater, surface water, and sediment. For Site 43, these media were assessed for potential risk to human receptors. Specifically, surface water and sediment samples were collected from the two surface water bodies of concern at the site: Strawhorn Creek and Edwards Creek. For a detailed description of the sampling procedure, see Section 3.0.

In addition, the shallow and deep groundwater at Site 43 were evaluated as a single exposure source. Although shallow groundwater is not used potably at the sites, it has been shown that there is a potential interconnection between the shallow and deep aquifers (see Section 3.0). Consequently, exposure to both sources of groundwater were evaluated. Current receptors (military personnel, military dependents, and civilian base personnel) are exposed via ingestion, dermal contact, and inhalation to groundwater drawn from the deep zone. Hence, assessing current risks to contaminants detected in the shallow aquifer for current receptors is unnecessary and, if estimated, may present an unlikely risk. Therefore, groundwater exposure to current receptors was not estimated for this investigation.

Information relating to the nature and extent of contamination at the site is provided in Section 4.0 of this report. The discussion provided in Section 4.0 also was utilized in the selection of COPCs at the site. The reduced data sets for all media of concern at the site are provided in Appendices H and I of this report.

6.2.3 Criteria Used in Selection of COPCs

This section presents the criteria used in the selection of COPCs for the evaluation of potential human health risk. As exemplified by the data summary tables in Appendices H and I, the number of constituents positively detected at least once during the field investigation is large. Quantifying risk for all positively identified parameters may distract from the dominant risks presented by the site. Therefore, the data set (resulting data set after applying the criteria listed in the previous section) was reduced to a list of COPCs. As stated previously, COPCs are site-related contaminants used to quantitatively estimate human exposures and associated potential health effects.

The selection of the COPCs was based on a combination of detected concentrations; toxicity; frequency of detection; comparison to background values, including site-specific, base-specific and published ranges; and comparison of physiochemical properties, including mobility, persistence, and toxicity. In addition, historical information pertaining to past site activities was considered. USEPA guidance states that a contaminant may not be retained for quantitative evaluation in the BRA if: (1) it is detected infrequently in an environmental medium (e.g., equal to or less than 5 percent

for at least 20 samples per data set), (2) it is absent or detected at low concentrations in other media, or (3) site history does not provide evidence the contaminant to be present (USEPA, 1989). To qualitatively assess the COPCs, comparisons of results to federal and state criteria and Region III Contaminant of Concern (COC) Screening Values (USEPA, 1994) were used. A brief description of the selection criteria used in choosing final COPCs is presented below. A contaminant did not need to meet the criteria of all of these three categories in order to be retained as a COPC.

6.2.3.1 Site Setting

The Agan Street Dump (Site 43) is comprised of approximately 11 acres and is located within the operations area of Marine Corps Air Station (MCAS) New River, 2 miles east of the main entrance. There is vehicle access to the site via Agan Street, from Curtis Road. Site 43 is located at the northern terminus of Agan Street, adjacent to an abandoned sewage disposal facility. The site is bordered to the north by Edwards Creek, to the east and south by Strawhorn Creek, and to the west by Agan Street and the former sewage disposal facility. Strawhorn Creek discharges into Edwards Creek at Site 43. Edwards Creek then discharges into the New River approximately 2,000 feet north of the study area, near Site 36.

Much of the study area is heavily vegetated with dense understory and trees greater than three inches in diameter. Marsh areas prone to flooding line both Strawhorn and Edwards Creeks. An improved gravel loop road provides access to the main portion of the study area, other unimproved paths extend outward from this road. Presently, access to Site 43 is unrestricted.

6.2.3.2 Frequency of Detection

In general, constituents that were detected infrequently (e.g., equal to or less than 5 percent, when at least 20 samples of a medium are available) may be anomalies due to sampling or analytical errors or may be present simply in the environment due to past or current site activities. It should be noted, however, that detected constituents were individually evaluated prior to exclusion from the BRA. Physiochemical properties (i.e., fate and transport) and toxicological properties for each detected constituent were evaluated (see following sections).

6.2.3.3 Comparison to Background

Sample concentrations were compared to site-specific (i.e., twice the base-specific average concentration for soil constituents) background levels. Background information was available for all media of concern at the site, except groundwater. The results of these comparisons are presented in Tables 6-1 through 6-7.

6.2.3.4 Physiochemical Properties

Mobility

The physical and chemical properties of a contaminant are responsible for its transport in the environment. These properties, in conjunction with site conditions, determine whether a contaminant will tend to volatilize into the air from surface soils or surface waters or be transported via advection or diffusion through soils, groundwaters, and surface waters. Physical and chemical properties also describe a contaminant's tendency to adsorb onto soil/sediment particles.

Environmental mobility can correspond to either an increased or decreased potential to affect human health and/or the environment.

Persistence

The persistence of a contaminant in the environment depends on factors such as the microbial content of soil and water, organic carbon content, the concentration of the contaminant, climate, and the ability of the microbes to degrade the contaminant under site conditions. In addition, chemical degradation (i.e., hydrolysis), photochemical degradation, and certain fate processes such as sorption may contribute to the elimination or retention of a particular compound in a given medium.

6.2.3.5 Toxicity

The potential toxicity of a contaminant is an important consideration when selecting COPCs for further evaluation in the human health assessment. For example the weight-of-evidence (WOE) classification should be considered in conjunction with concentrations detected at the site. Some effects considered in the selection of COPCs include carcinogenicity, mutagenicity, teratogenicity, systemic effects, and reproductive toxicity. Bioaccumulation and bioconcentration properties may affect the severity of the toxic response in an organism and/or subsequent receptors and are evaluated if relevant data exist.

Despite their inherent toxicity, certain inorganic contaminants are essential nutrients. Essential nutrients need not be considered for further consideration in the quantitative risk assessment if they are present in relatively low concentrations (i.e., below twice the average base-specific background levels or slightly elevated above naturally occurring levels) or if the contaminant is toxic at doses much higher than those which could be assimilated through exposures at the site. Due to the difficulty of determining nutrient levels that were within acceptable dietary levels, only essential nutrients present at low concentrations (i.e., only slightly elevated above background) were eliminated from the BRA. Essential nutrients, however, were included in the ecological risk evaluation.

6.2.3.6 Contaminant Concentrations in Blanks

If a chemical is detected in both the environmental sample and a blank sample, it may not be retained as a COPC in accordance with RAGS depending on the concentration on the chemical in the media. Therefore, blank data were compared with results from environmental samples. If the blanks contained detectable results for common laboratory contaminants (i.e., acetone, 2-butanone, methylene chloride, toluene, and phthalate esters), environmental sample results were considered as positive results only if they exceed 10 times the maximum amount detected in the associated blank. If the chemical detected in the blank(s) is not a common laboratory contaminant, environmental sample results were considered as positive results only if they exceeded five times the maximum amount detected in the associated blank(s).

For Site 43, the following organics were found in the blanks: acetone (24 µg/L), chloroform (13 µg/L), 2-butanone (32 µg/L), trichloroethene (1 µg/L), bis(2-ethylhexyl)phthalate (36 µg/L), bromodichloromethane (13 µg/L), and dibromochloromethane (10 µg/L).

6.2.3.7 Federal and State Criteria and Standards

Contaminants detected at the site were compared to state and federal standards, criteria, and/or To Be Considered levels (TBCs). These comparisons may provide some qualitative information as to the relative potential for health impacts resulting from the site. It should be noted that COPC concentration ranges were directly compared to each standard/criteria/TBC. This comparison did not take into account the additive or synergistic effects of those constituents without standards or criteria. Consequently, conclusions regarding potential risk posed by each site cannot be inferred from this comparison. A brief explanation of the standards/criteria/TBCs used for the evaluation of COPCs is presented below.

North Carolina Water Quality Standards (NCWQSs) - Groundwater - NCWQSs are the maximum allowable concentrations resulting from any discharge of contaminants to the land or waters of the state, which may be tolerated without creating a threat to human health or which otherwise render the groundwater unsuitable for its intended purpose.

Maximum Contaminant Levels (MCLs) - Federal Groundwater Standards - 40 CFR 161 - MCLs are enforceable standards for public water supplies promulgated under the Safe Drinking Water Act and are designed for the protection of human health. MCLs are based on laboratory or epidemiological studies and apply to drinking water supplies consumed by a minimum of 25 persons. They are designed for prevention of human health effects associated with a lifetime exposure (70-year lifetime) of an average adult (70 kg) consuming 2 liters of water per day. MCLs also consider the technical feasibility of removing the contaminant from the public water supply.

North Carolina Water Quality Standards (Surface Water) - The NCWQSs for surface water are the standard concentrations that, either alone or in conjunction with other wastes in surface waters, will neither render waters injurious to aquatic life, wildlife, or public health, nor impair the waters for any designated use.

Ambient Water Quality Criteria - AWQCs are non-enforceable regulatory guidelines and are of primary utility in assessing acute and chronic toxic effects in aquatic systems. They may also be used for identifying the potential for human health risks. AWQCs consider acute and chronic effects in both freshwater and saltwater aquatic life, and potential carcinogenic and noncarcinogenic health effects in humans from ingestion of both water (2 liters/day) and aquatic organisms (6.5 grams/day), or from ingestion of water alone (2 liters/day). The human health AWQCs for potential carcinogenic substances are based on the USEPA's specified incremental cancer risk range of one additional case of cancer in an exposed population of 10,000,000 to 100,000 (i.e. the 10E-7 to 10E-5 range).

Region IV Sediment Screening Values - Currently, federal sediment quality criteria for the protection of aquatic life are being developed. In the interim, the USEPA Region IV Waste Management Division recommends using sediment values, compiled by the National Oceanic and Atmospheric Administration (NOAA), as screening values for evaluating the potential for chemical constituents in sediments to cause adverse biological effects. NOAA developed this screening method through evaluating biological effects data for marine and freshwater organisms obtained through equilibrium partitioning calculations, spiked-sediment bioassays, and concurrent biological and chemical field surveys. For each constituent having sufficient data available, the concentrations causing adverse biological effects were arrayed, and the lower 10 percentile (called an Effects Range-Low, or ER-L) and the median (called an Effects Range-Median, or ER-M) were determined.

If sediment contaminant concentrations are above the ER-M, adverse effects on the biota are considered probable. If contaminant concentrations are between the ER-L and the ER-M, adverse effects are considered possible, and the USEPA recommends conducting sediment toxicity tests as a follow-up. If contaminant concentrations are below the ER-L, adverse effects are considered unlikely.

Health Advisories (HAs) - HAs are guidelines developed by the USEPA Office of Drinking Water for nonregulated constituents in drinking water. These guidelines are designed to consider both acute and chronic toxic effects in children (assumed body weight 10 kg) who consume 1 liter of water per day or in adults (assumed body weight 70 kg) who consume 2 liters of water per day. HAs are generally available for acute (1 day), subchronic (10 days), and chronic (longer-term) exposure scenarios. These guidelines are designed to consider only threshold effects and, as such, are not used to set acceptable levels of potential human carcinogens.

USEPA Region III COC Screening Values: COC screening values are derived using conservative USEPA promulgated default values and the most recent toxicological criteria available. COC screening values for potentially carcinogenic and noncarcinogenic chemicals are individually derived based on a target incremental lifetime cancer risk (ILCR) of 1×10^{-6} and a target hazard quotient of 0.1, respectively. For potential carcinogens, the toxicity criteria applicable to the derivation of COC screening values are oral and inhalation cancer slope factors; for non carcinogens, they are chronic oral and inhalation reference doses. These toxicity criteria are subject to change as more updated information and results from the most recent toxicological/epidemiological studies become available. Therefore, the use of toxicity criteria in the derivation of COC screening values requires that the screening concentrations be updated periodically to reflect changes in the toxicity criteria.

Since the most recent COC screening values table was issued by USEPA in March 1995, the values from these tables can be updated by incorporating information from another set of tables containing risk-based concentrations (RBCs) that are issued by USEPA Region III on a quarterly basis. The RBCs are derived using the same equations and USEPA promulgated default exposure assumptions that were used by Region III to derive the COC screening values. In addition, the quarterly RBCs for potentially carcinogenic chemicals are based on a target ILCR of 1×10^{-6} . The only difference in the derivation methodologies for the COC screening values and the RBCs is that the RBCs for noncarcinogens are based on a target hazard quotient of 1.0 rather than 0.1. The COC screening values for noncarcinogens are to be derived based on a target hazard quotient of 0.1, to account for cumulative risk from multiple chemicals in a medium. Re-derivation of the quarterly noncarcinogenic RBCs based on a target hazard quotient of 0.1, while using the most recent toxicological criteria available, results in a set of values that can be used, as a COC screening values. In other words, an updated set of COC screening values can be attained each quarter by using the carcinogenic RBCs issued quarterly by USEPA Region III and dividing the accompanying noncarcinogenic RBCs by a factor of 10.

As stated previously, COPCs in all media of concern at the site were compared these aforementioned criteria. The results of the standards/criteria/TBC comparison for the site are presented in Tables 6-1 through 6-7.

6.2.4 Contaminants of Potential Concern (COPCs)

The following sections present an overview of the analytical data obtained for each medium and the subsequent retention or elimination of chemicals as COPCs using the aforementioned criteria for selection of COPCs.

6.2.4.1 Surface Soil

No volatile organic contaminants (VOCs) were detected in surface soil. Therefore, no VOCs were retained as surface soil COPCs.

Twenty-eight surface soil samples were analyzed for semivolatile organic contaminants (SVOCs). The following polynuclear aromatic hydrocarbons (PAHs) were detected at maximum concentrations below respective Region III residential soil COC screening values: acenaphthylene, acenaphthene, fluorene, anthracene, phenanthrene, carbazole, fluoranthene, pyrene, benzo(g,h,i)perylene, and chrysene. Two phthalate esters, butylbenzylphthalate and bis(2-ethylhexyl)phthalate, were detected at maximum concentrations below respective residential soil screening values. 4-Methylphenol, 2-methylnaphthalene, and dibenzofuran were also detected at maximum concentrations below their corresponding residential soil screening values. Therefore, these contaminants are not retained as COPCs.

The following six potentially carcinogenic PAHs are retained as surface soil COPCs since they exceed their respective residential soil screening values and were detected frequently: benzo(a)anthracene (32%), benzo(b)fluoranthene (36%), benzo(k)fluoranthene (32%), benzo(a)pyrene (32%), indeno(1,2,3-cd)pyrene (36%), and dibenz(a,h)anthracene (29%).

Seven surface soil samples were analyzed for pesticide/PCBs. Heptachlor epoxide, 4,4'-DDE, 4,4'-DDT, and endrin aldehyde were detected at maximum concentrations less than respective residential soil screening values. For this reason, these contaminants are not retained as surface soil COPCs.

4,4'-DDD is retained as a surface soil COPC since it exceeds its residential soil screening value.

Twenty-one surface soil samples were analyzed for inorganic contaminants. Arsenic is not retained as a COPC because its maximum detected concentration is less than twice base background concentration in surface soil. The following contaminants were detected at maximum concentrations less than respective residential soil screening values: cadmium, cobalt, copper, lead, manganese, mercury, nickel, selenium, vanadium, and zinc. For this reason, these contaminants are not retained as COPCs. Calcium, magnesium, potassium, and sodium are excluded because these inorganics are considered essential nutrients.

Aluminum (100%), barium (100%), chromium (100%), and iron (100%) were detected frequently and at concentrations that exceeded their corresponding residential soil screening values. Thus, these metals are retained as surface soil COPCs. Organic and inorganic results are summarized in Tables 6-1 and 6-2, respectively.

6.2.4.2 Subsurface Soil

No VOCs were detected in subsurface soil. Therefore, no VOCs are retained as subsurface soil COPCs.

Twenty subsurface soil samples were analyzed for SVOCs. The following PAHs were detected at maximum concentrations less than respective residential soil screening values: phenanthrene, carbazole, fluoranthene, pyrene, benzo(a)anthracene, chrysene, benzo(b)fluoranthene, benzo(k)fluoranthene, indeno(1,2,3-cd)pyrene, dibenz(a,h)anthracene, and benzo(g,h,i)perylene. Two phthalate esters, butylbenzylphthalate and bis(2-ethylhexyl)phthalate, were also detected at maximum concentrations less than respective residential soil screening values. Therefore, these contaminants are not retained as subsurface soil COPCs.

Benzo(a)pyrene, indeno(1,2,3-cd)pyrene, and dibenzo(a,h)anthracene were retained as COPCs since they were detected at frequencies of 5% and concentrations greater than their respective residential soil screening values.

Seven subsurface soil samples were analyzed for pesticide/PCBs. 4,4'-DDE, 4,4'-DDD, and 4,4'-DDT were detected at concentrations less than respective residential soil screening values. For this reason, these contaminants are not retained as COPCs.

Twenty subsurface soil samples were analyzed for inorganic contaminants. Arsenic is not retained as a COPC because its maximum detected concentration is less than twice base background for subsurface soil. The following inorganics were detected at concentrations less than respective residential soil screening values: aluminum, barium, chromium, cobalt, copper, lead, manganese, nickel, selenium, vanadium, and zinc. In addition, calcium, magnesium, potassium, and sodium are excluded because they are considered essential nutrients. Thus, these inorganic analytes are not retained as COPCs.

Iron was detected at a frequency of 100% and at a maximum concentrations exceeding its residential soil screening value. Therefore it was retained as a subsurface soil COPC. Organic and inorganic results are presented in Tables 6-3 and 6-4, respectively.

6.2.4.3 Shallow and Deep Groundwater

No VOCs were detected in groundwater. Therefore, no VOCs are retained as groundwater COPCs.

Ten groundwater samples were analyzed for SVOCs. 4-Methylphenol was detected at a maximum concentration less than the Region III tap water COC screening value. For this reason, it is not retained as a COPC.

No pesticide/PCBs were detected in groundwater samples. Therefore, no pesticide/PCBs are retained as groundwater COPCs.

Ten groundwater samples were analyzed for inorganic contaminants. The following inorganics were detected at maximum concentrations less than respective tap water screening levels: barium, cobalt, copper, manganese, nickel, vanadium, and zinc. Lead was detected at a maximum concentration less than the Federal MCL action level of 15 µg/L. For this reason, these analytes are not retained as COPCs. Calcium, magnesium, potassium, and sodium are not retained as COPCs because these inorganic contaminants are considered essential nutrients.

Aluminum (90%) and iron (100%) were detected frequently and at concentrations exceeding corresponding tap water screening criteria. For this reason, aluminum and iron are retained as a groundwater COPCs. These results are shown in Table 6-5.

6.2.4.4 Surface Water

Six surface water samples were analyzed for VOCs. 1,2-Dichloroethene (total) was detected in two of six surface water samples (i.e., a frequency of 33%). Therefore, 1,2-Dichloroethene (total) is retained as a surface water COPC.

Six surface water samples were analyzed for SVOCs. Bis(2-ethylhexyl)phthalate, a common laboratory contaminant, was detected in one of six samples at a concentration less than ten times the level detected in the blanks (i.e., 200 µg/L vs. 360 µg/L). For this reason, it is not retained as a COPC.

Six surface water samples were analyzed for pesticide/PCBs. 4,4'-DDE was detected at a frequency of 33%, and 4,4'-DDD was detected at a frequency of 50%. 4,4'-DDE and 4,4'-DDD are retained as surface water COPCs.

Six surface water samples were analyzed for inorganic contaminants. Calcium, magnesium, potassium, and sodium are not retained as COPCs since these contaminants are considered essential nutrients.

Aluminum, arsenic, barium, copper, iron, lead, manganese and vanadium were detected frequently in surface water samples. Aluminum, barium, and iron were detected at concentrations that exceed background levels. Thus, these metals are retained as surface water COPCs. Arsenic, copper, lead, manganese, and vanadium were not detected in background samples. These analytes are also retained as surface water COPCs. A summary of these results is shown in Table 6-6.

6.2.4.5 Sediment

Twelve sediment samples were analyzed for VOCs. Acetone and carbon disulfide were detected in three of twelve samples. Acetone was detected in blanks. As a result, it was not retained as a sediment COPC. However, carbon disulfide was not detected in blanks. Therefore, carbon disulfide is retained as sediment COPC.

Twelve sediment samples were analyzed for SVOCs. Bis(2-ethylhexyl)phthalate, a common lab contaminant, was detected in ten of twelve sediment samples at a maximum concentration greater than the level detected in blanks. Hence, it is retained as a sediment COPC. 4-Methylphenol (8%), pyrene (8%), and benzo(a)pyrene (33%) were detected frequently and retained as sediment COPCs.

Twelve sediment samples were analyzed for pesticide/PCBs. 4,4'-DDE, 4,4'-DDD, 4,4'-DDT, alpha-chlordane, and gamma-chlordane were detected frequently and above background levels. Thus, these contaminants are retained as sediment COPCs. Endrin was detected in two of eleven sediment samples and was not detected in background samples. Endrin is also retained as a sediment COPC.

Twelve sediment samples were analyzed for inorganic contaminants. Calcium, magnesium, potassium, and sodium are not retained as COPCs because these analytes are considered essential nutrients.

Aluminum, arsenic, barium, beryllium, cadmium, chromium, copper, iron, lead, manganese, mercury, selenium, silver, vanadium, and zinc were detected frequently and at concentrations exceeding background levels. Cobalt and nickel were also detected frequently but were not detected

in background samples. Therefore, these inorganic contaminants are retained as sediment COPCs. These results are presented in Table 6-7.

6.3 Exposure Assessment

The exposure assessment addresses each potential exposure pathway via soil (surface and subsurface), groundwater, surface water, sediment, biota, and air. To determine the likelihood of human exposure via these pathways in the absence of remedial action, an analysis including the identification and characterization of exposure pathways was conducted. The following four elements were examined to determine if a complete exposure pathway was present:

- 1) a source and mechanism of chemical release
- 2) an environmental transport medium
- 3) a feasible receptor exposure route
- 4) a receptor exposure point

The exposure scenarios presented in the following sections are used to estimate individual risks. Unless otherwise noted, all the statistical data associated with the factors used in the dose evaluation equations for assessing exposure were obtained from the Exposure Factors Handbook (USEPA, 1989b) and the accompanying guidance manuals. A reasonable maximum exposure (RME) scenario was utilized in this assessment, which is consistent with USEPA Region IV recommendations regarding human health risk assessment. As a result, the exposure scenarios presented include RME assumptions for the input parameters in the dose evaluation equations. These values are summarized in Table 6-8.

6.3.1 Potential Human Receptors and Adjacent Populations

The following sections provide a discussion of the potential exposure pathways and receptors at Site 43.

6.3.1.1 Site Conceptual Model for Site 43

A site conceptual model of potential sources, migration pathways and human receptors was developed to encompass all current and future potential routes of exposure at the site. This document is presented in Appendix Q. Figure 6-1 presents the potential exposure pathways and receptors for Site 43. Qualitative descriptions of current and future land use patterns in the vicinity of OU No. 6 were provided in the model. All available analytical data and meteorological data were considered in addition to general understanding of the demographics of surrounding communities.

From this information, the following general list of potential receptors was developed for inclusion in the quantitative health risk analysis for Site 43:

- Current military personnel
- Current trespassers (young child and adult)
- Future on-site residents (young child and adult)
- Future construction worker

The following sections present a discussion of the potential exposure pathways and receptors at Site 43.

6.3.1.2 Current and Future Scenarios

Site 43 no longer serves as a municipal waste dump. Currently, Site 43 has no official use.

Receptors exposed to surface soil include: future residents (i.e., young children and adults), current military personnel, and current trespassers (i.e., young children and adults) from adjacent, off-site residences. The young child receptor is one to six years of age. Surface soil exposure pathways for these receptors include incidental ingestion, dermal contact, and inhalation of fugitive dust.

Future construction workers are the only receptors exposed to subsurface soil. Exposure to subsurface soil may occur during ground excavation for on-site construction activities. Exposure pathways include incidental ingestion of subsurface soil, dermal contact with subsurface soil and inhalation of fugitive dust.

Presently, groundwater at Site 43 is not used for potable supplies. For this reason, current groundwater exposure is not evaluated. In a future scenario, it is possible that residential development may occur at Site 43. Consequently, future groundwater exposure was assessed for residential children and adults. Groundwater exposure was not evaluated for future military personnel. Groundwater exposure pathways include ingestion, dermal contact with groundwater and inhalation of volatilized constituents while showering.

In addition, the shallow and deep groundwater at Site 43 were evaluated as a single exposure source. Although shallow groundwater is not used for potable supplies at the sites, it has been shown that there is a potential interconnection between the shallow and deep aquifers (see Section 3.0). Consequently, exposure to both sources of groundwater as one unit were evaluated.

Receptors exposed to surface water and sediment are current on-site trespassers and future residents. It should be noted that the two water bodies at Site 43, Strawhorn Creek and Edwards Creek, were evaluated as one source because Strawhorn Creek flows into Edwards Creek at Site 43. Exposure pathways for these receptors are incidental ingestion of surface water/sediment and dermal contact with surface water/sediment.

Figure 6-1 presents a flowchart of the potential exposure pathways and receptors at Site 43.

6.3.2 Migration and Exposure Pathways

In general, the migration of COPCs from site soil sources could potentially occur by the following routes:

- Vertical migration of potential contaminants from surficial soils to subsurface soils.
- Leaching of potential contaminants from subsurface soils to the water-bearing zones.
- Vertical migration from shallow water-bearing zones to deeper flow systems.
- Horizontal migration in groundwater in the direction of groundwater flow.
- Groundwater discharge into local streams.
- Wind erosion and subsequent deposition of windblown dust.

The potential for a constituent to migrate spatially and persist in environmental media is important in the estimation of potential exposure. This section describes the potential exposure pathways

presented on Figure 6-1 associated with each medium and each potential human receptor group, then qualitatively evaluates each pathway for further consideration in the quantitative risk analysis. Table 6-9 presents the potential human exposure scenarios for this site.

6.3.2.1 Surface Soil

The potential release source considered in the soil pathway was the chemical residuals in the surface soils. The release mechanisms considered were volatilization, fugitive dust generation/deposition, leaching, and surface runoff. The transport media were the surface soils and air. The routes for human exposure to the contaminated soils included inhalation, ingestion, and dermal contact. Potential exposure points from the site were areas of human activity on and adjacent to the site.

Soil Ingestion and Dermal Contact

Incidental ingestion and dermal contact with surface soil in the current case are complete exposure pathways at Site 43. These exposure pathways were evaluated for current military personnel, current adult and child trespassers, and future adult and child residents.

Soil Inhalation Via Volatilization

Surface soil represents a potential source of exposure at the site via volatilization of organic COPCs. The potentially exposed populations included current military personnel, current trespassers, future residents. Future construction workers may inhale volatilized COPCs emanating from excavated subsurface soil. However, no VOCs were identified as COPCs in either surface or subsurface soil at the site. As a result, this pathway was not considered to be significant for the site and was not evaluated for soils.

Soil Inhalation Via Fugitive Dust Generation

The surface soils in the current case and the subsurface soils in the future case represent a potential source of exposure at the site via fugitive dust generation from wind erosion and vehicular traffic on surface soils. Current military personnel, trespassers, future residents, and future construction workers (subsurface soil only) may inadvertently inhale the contaminated particulates as dust while engaging in outdoor activities. As a result, particulate inhalation was a complete pathway. The noted receptors were evaluated for exposure to fugitive dusts via inhalation.

6.3.2.2 Subsurface Soil

The potential release source considered in the subsurface soil pathway was the chemical residuals in the contaminated soils. The release mechanism considered is leaching to groundwater. The transport medium was the groundwater infiltrating the subsurface soil. Therefore, exposure to subsurface soils would be indirect (i.e., leaching of contaminants to groundwater). As such, subsurface soil exposure was addressed in the groundwater pathway analysis. Additionally, subsurface soil exposure was mentioned as part of the soil medium. It is assumed that the subsurface soil would be excavated and used as surface grading, landscaping, etc., in the foreseeable future. As a result, exposure to subsurface soil via ingestion, dermal contact, and inhalation was evaluated for the construction worker receptor. It was assumed that this exposure would result from outdoor construction activities.

6.3.2.3 Groundwater

The potential release source considered in evaluating the groundwater pathway was contaminated soils. The release mechanism considered was soil leaching. The transport medium was the groundwater. The routes considered for human exposure to the groundwater were direct ingestion of groundwater, dermal contact, and inhalation of volatilized contaminants during showering. However, since there were no VOCs retained as groundwater COPCs, inhalation was not evaluated as an exposure pathway at Site 43.

Residences located on-site in the future scenario were considered to be potential exposure points. At present, on-site groundwater is not potable. As a result, groundwater exposure from on-site sources is not significant and was not evaluated for potential risk in the current scenario. In the future scenario, it is conservatively assumed that a potable well could be installed on-site. However, as stated previously, it is not expected that this residential scenario will be implemented in the future at these military sites. Regardless, future groundwater risks on-site were assessed conservatively in accordance with guidance.

6.3.2.4 Surface Water

Potential release sources considered in evaluating the surface water pathway were the contaminated soils and groundwater. The release mechanisms considered were surface runoff and groundwater seepage. The transport medium was the surface water. The potential routes considered for human exposure to the contaminated surface water were incidental ingestion and dermal contact. Potential exposure points were areas of human activity on and adjacent to the site. At Site 43 children and adults were evaluated for exposure to surface water during wading activities from Strawhorn Creek and Edwards Creek. As previously mentioned, these two creeks were evaluated as a single source since Strawhorn Creek discharges into Edwards Creek at Site 43.

6.3.2.5 Sediment

The chemical residuals in the contaminated soils and groundwater were the potential release sources to be considered in the sediment pathway. The routes for human exposure to the contaminated sediments by the sediment pathway included ingestion and dermal contact. Potential exposure points from the site were areas of human activity adjacent to the site.

The receptors previously described for evaluation of surface water exposure pathways were assumed to also come in contact with the underlying sediment while engaging in outdoor activities. Consequently, the receptors identified for the surface water exposure pathway were also evaluated for exposure to sediment in the current and future scenarios.

6.3.2.6 Air

There are two potential release mechanisms to be considered in evaluating the atmospheric pathway: release of contaminated particulates (i.e., fugitive dust generation) and volatilization of contaminants from soil and groundwater. The transport mechanism is the air, and the potential exposure points are the areas of human activity on and adjacent to the site.

Fugitive Dust Generation

This air pathway was evaluated as a source of exposure outdoors at the site via fugitive dust generation of contaminants. Air exposure may occur when surface soils become airborne due to wind erosion or vehicular traffic. It is assumed that military personnel, child and adult receptors, and the construction worker may inhale soil particulates while engaging in outdoor activities. This scenario is applicable for both the current and future cases. This exposure pathway is further assessed in Section 7.3.2.

Volatilization

The volatilization of contaminants from groundwater is a potential source of contaminant exposure. It is assumed in the future scenario that an adult and child receptor will inhale volatilized contaminants present in groundwater while showering. However, there were no VOCs retained as COPCs in groundwater at Site 43. Hence, this pathway was not considered to be significant for the site and was not evaluated for the groundwater. A discussion of the volatilization of contaminants from surface soil can be found in Section 7.3.2.1.

6.3.2.7 Biota

The potential release sources to be considered in evaluating exposure via biota consumption are contaminated surface water and sediments. Biota can uptake contaminants present in these media by bioaccumulation and biomagnification. The exposure route for human receptors is ingestion.

At Site 43, it was not in the scope of work to collect fish and crab tissue samples. Consequently, biota consumption was not evaluated as an exposure pathway for Site 43.

6.3.3 Quantification of Exposure

The concentrations used in the estimation of chronic daily intakes (CDIs) must be representative of the type of exposure being considered. Exposure to groundwater, sediments, and surface waters can occur discretely or at a number of sampling locations. These media are transitory in that concentrations change frequently over time. Averaging transitory data obtained from multiple locations is difficult and requires many more data points at discrete locations than exist within this site. As a result, the best way to represent groundwater, sediment, and surface water contaminants from an exposure standpoint is to use a representative exposure concentration. Soils are less transitory than the aforementioned media and in most cases, exposure occurs over a wider area (i.e., residential exposure). Therefore, an upper confidence interval was used to represent a soil exposure concentration. Soil data collected from each of these areas was used separately in estimating the potential human health risks under current and future exposure scenarios. The human health assessment for future groundwater use considered groundwater data collected from all of the monitoring wells within a site and estimated risks to individuals per area of concern.

The manner in which environmental data are represented depends on the number of samples and sampling locations available for a given area and a given medium. Ninety-fifth percent (95%) upper confidence limit (UCL) values of the arithmetic mean for a lognormal distribution were used as exposure point concentrations for surface, subsurface soil, groundwater, surface water, and sediment. For the sake of conservatism, the 95 percent UCL for the lognormal distribution was used for each contaminant in a given data set for quantifying potential exposure. For exposure areas with limited

amounts of data or extreme variability in measured data, the 95 percent UCL can be greater than the maximum measured concentration; therefore, in cases where the 95 percent UCL for a contaminant exceeds the maximum detected value in a given data set, the maximum result was used in the estimate of exposure of the 95 percent UCL. However, the true mean may still be higher than this maximum value (i.e., the 95 percent UCL indicates a higher mean is possible), especially if the most contaminated portion of the site has not been sampled.

The 95 % UCL of the lognormal distribution was calculated using the following equation (USEPA, 1992b):

$$UCL = \exp(\bar{x} + sH/\sqrt{n-1})$$

where:

UCL	=	upper confidence limit
exp	=	constant (base of the natural log, equal to 2.718)
\bar{x}	=	mean of the transformed data
s	=	standard deviation of the transformed data
H	=	H-statistic
n	=	number of samples

The following criteria were used to calculate media-specific average concentrations for each parameter that was detected at least once:

- For results reported as "non-detect" (e.g., ND, U, etc.), a value of one-half of the sample-specific detection limit was used to calculate the mean. The use of one-half the detection limit commonly is assigned to non-detects when averaging data for risk assessment purposes, since the actual value could be between zero and a value just below the detection limit.
- Reported concentrations that were less than the detection limit were used to calculate the mean. Typically, these values are qualified with a "J" meaning that the value was estimated.
- The organic analytical results qualified with a "B" were not retained in the data set. The "B" qualifier means that the detected concentration was less than either five times or ten times the blank concentration (i.e., the 5-10 rule), depending upon the parameter. Common laboratory contaminants, such as phthalate esters, toluene, methylene chloride, methyl ethyl ketone, and acetone, follow the five times rule, while all other parameters follow the ten times rule (USEPA, 1989).
- Reported concentrations qualified with "R" were excluded from the data set. The data flag "R" means that the QA/QC data indicated that analytical results were not usable for quantitative purposes.

The reduced data were summarized by medium and analytical parameter type (i.e., organics and inorganics) for the site. For each parameter detected during the sampling programs, the frequency

of detection, maximum concentration, minimum concentration, average (arithmetic mean) concentration, and both the normal and lognormal upper 95 percent level for the arithmetic average were summarized. This information is presented in Appendix H and I. It should be noted that the number of times analyzed may differ per parameter per media per area of concern. This is primarily due to rejected data that were excluded from the data set. Consequently, these data are not reflected in the number of times analyzed. Data and frequency summaries and statistical summaries are presented in Appendices H and I, respectively.

6.3.4 Calculation of Chronic Daily Intakes

In order to numerically estimate the risks for current and future human receptors at Site 43, a CDI must be estimated for each COPC in every retained exposure pathway. Appendix R contains the specific CDI equations for each exposure scenario of interest. These equations were obtained from USEPA guidance (USEPA, 1989).

The following paragraphs present the general equations and input parameters used in the calculation of CDIs for each potential exposure pathway. Input parameters were taken from USEPA's default exposure factors guidelines where available and applicable. All inputs not defined by USEPA were derived from USEPA documents concerning exposure or from best professional judgment. All exposure assessments incorporate the representative contaminant concentrations in the estimation of intakes. Therefore, only one exposure scenario was developed for each exposure route/receptor combination.

CDIs calculated for carcinogens incorporate terms to represent the exposure duration (years) over the course of a lifetime (70 years, or 25,550 days). CDIs for noncarcinogenics, on the other hand, were estimated using the concept of an average annual exposure. The intake incorporates terms describing the exposure time and/or frequency representing the number of hours per day and the number of days per year that exposure occurs. In general, noncarcinogenic risks for many exposure routes (e.g., soil ingestion) are greater for children than adults because of the differences in body weights, similar exposure frequencies, and higher ingestion rates.

Future residential exposure scenarios consider 1 to 6 year old children weighing 15 kg and adults weighing 70 kg on average (USEPA, 1989). For current military personnel, an exposure duration of 4 years was used to estimate a military residence. A one-year duration was used for future construction worker exposure scenarios.

6.3.4.1 Incidental Ingestion of Soil

The CDI for COPCs detected in soil was estimated for all potential human receptors and was expressed as:

$$CDI = \frac{C \times IR \times Fi \times CF \times EF \times ED}{BW \times AT}$$

Where:

- C = Contaminant concentration in soil (mg/kg)
- IR = Ingestion rate (mg/day)
- Fi = Fraction ingested from source (dimensionless)
- CF = Conversion factor (1x10⁻⁶ kg/mg)

EF	=	Exposure frequency (days/year)
ED	=	Exposure duration (years)
BW	=	Body weight (kg)
AT	=	Averaging time (days)

The following paragraphs discuss the exposure assumptions used in the estimation of exposure to COPCs associated with the potential ingestion of soils.

Military Personnel

During the course of daily activities at Site 43, military personnel could potentially be exposed to COPCs by the incidental ingestion of surface soils. The IR for military personnel exposed to surficial soils was assumed to be 100 mg/day (USEPA, 1989). The fraction ingested from the source was assumed to be 100 percent. An exposure frequency (EF) of 250 days per year (USEPA, 1991) was used in conjunction with an exposure duration of 4 years. An averaging time (AT) of 70 years or 25,550 days was used for exposure to potentially carcinogenic compounds while an averaging time of 1,460 (4 years x 365 days/year) days was used for noncarcinogenic exposures. An adult average body weight (BW) of 70 kg was used (USEPA, 1989).

Trespassers

Current trespassers could potentially be exposed to COPCs in the surficial soils while outdoors. Children and adults could potentially be exposed to COPCs in soils by incidental ingestion via hand to mouth contact. Ingestion rates (IR) for adults and children in this scenario were assumed to be 100 mg/day and 200 mg/day, respectively (USEPA, 1991). EFs for the receptor groups were assumed to be 130 days per year (child) and 43 days/year (adult) (USEPA, 1992). These values represent exposure frequencies of individuals who spend a limited amount of time on-site. The exposure duration (ED) was 6 years (child) and 30 years (adult) (USEPA, 1991). Averaging times of 25,550 days for potential carcinogens and 10,950 days (30 years x 365 days/year) for noncarcinogenic constituents were used for estimating potential CDIs for adults. An AT of 2,190 days (6 years x 365 days/year) was used to estimate potential CDIs for children potentially exposed to noncarcinogens.

Future On-Site Residents

Future on-site residents could potentially be exposed to COPCs in the surficial soils during recreational or landscaping activities around their homes. Children and adults could potentially be exposed to COPCs in soils by incidental ingestion via hand to mouth contact. Ingestion rates (IR) for adults and children in this scenario were assumed to be 100 mg/day and 200 mg/day, respectively. EFs for both receptor groups were assumed to be 350 days per year (USEPA, 1991). The residential exposure duration (ED) was divided into two parts. First, a six-year exposure duration was evaluated for young children which accounts for the period of highest soil ingestion (200 mg/day), and second a 30-year exposure was assessed for older children and adults by using a lower soil ingestion rate (100 mg/day) (USEPA, 1991). The BW for a resident child was assumed to be 15 kg, representing younger individuals. The rationale was that the younger child (1 to 6 years), as a resident, will have access to affected on-site soils. The body weight for the future resident adult is assumed to be 70 kg. Averaging times of 25,550 days for potential carcinogens and 10,950 days (30 years x 365 days/year) for noncarcinogenic constituents was used for estimating

potential CDIs for adults. An AT of 2,190 days (6 years x 365 days/year) was used to estimate potential CDIs for children potentially exposed to noncarcinogens.

Construction Worker

During excavation activities, construction workers may be exposed to COPCs through the incidental ingestion of subsurface soil. The IR for future construction workers exposed to subsurface soils was assumed to be 480 mg/day (USEPA, 1991). An exposure frequency of 90 days per year was used in conjunction with an exposure duration of one year (USEPA, 1991). An adult BW of 70 kg was used.

A summary of the exposure factors used in the estimation of soil CDIs associated with incidental ingestion is presented in Table 6-8.

6.3.4.2 Dermal Contact with Soil

Chronic daily intakes associated with potential dermal contact of soils containing COPCs were expressed using the following equation:

$$CDI = \frac{C \times CF \times SA \times AF \times ABS \times EF \times ED}{BW \times AT}$$

Where:

C	=	Contaminant concentration in soil (mg/kg)
CF	=	Conversion factor (kg/mg)
SA	=	Skin surface available for contact (cm ²)
AF	=	Soil to skin adherence factor (1.0 mg/cm ²)
ABS	=	Absorption factor (dimensionless) - 0.01 for organics, 0.001 inorganics (USEPA, Region IV, 1992d)
EF	=	Exposure frequency (days/year)
ED	=	Exposure duration (years)
BW	=	Body weight (kg)
AT	=	Averaging time (days)

The following paragraphs discuss the exposure assumptions used in the estimation of exposure to COPCs from dermal contact with soils.

Military Personnel

There is a potential for base personnel to absorb COPCs by dermal contact. The exposed skin surface area (4,300 cm²) was limited to the head (1,180 cm²), arms (2,280 cm²), and hands (840 cm²) (USEPA, 1992). Values for exposure duration (ED), exposure frequency (EF), body weight (BW), and averaging time (AT) were the same as those used for the incidental ingestion of soil scenario. The values for AF and ABS were provided above and are in accordance with USEPA and Region IV guidance.

Trespassers

Current trespassers could be potentially exposed to COPCs in on-site soil through dermal contact experienced during activities near their homes. Skin surface areas (SA) used in this exposure scenario were developed for a reasonable worst case scenario for an individual wearing a short-sleeved shirt, shorts, and shoes. The exposed skin surface area was limited to the head, hands, forearms, and lower legs. Thus, applying 25 percent of the average total body surface area results in 5,000 cm² for adults. The exposed skin surface for a child (2,000 cm²) was estimated using an average of the 50th (0.866 m²) percentile body surface for a six year old child multiplied by 25 percent (USEPA, 1992). The average body surface area value is used due to the more limited exposure a trespasser would have as compared to a resident. Exposure duration, exposure frequencies, body weights, and averaging times were the same as those discussed for the incidental ingestion scenario presented previously. The values for AF and ABS were provided above and are in accordance with USEPA and Region IV guidance.

Future On-Site Residents

Future on-site residents could also be potentially exposed to COPCs in on-site soil through dermal contact experienced during activities near their homes. Skin surface areas (SA) used in the on-site resident exposure scenario were developed for a reasonable worst case scenario for an individual wearing a short-sleeved shirt, shorts, and shoes. The exposed skin surface area was limited to the head, hands, forearms, and lower legs. Thus, applying 25 percent of the upper bound value for total body surface area results in 5,800 cm² for adults. The exposed skin surface for a child (2,300 cm²) was estimated using an average of the 50th (0.866 m²) and the 95th (1.06 m²) percentile body surface for a six year old child multiplied by 25 percent (USEPA, 1992). Exposure duration, exposure frequencies, body weights, and averaging times were the same as those discussed for the incidental ingestion scenario presented previously. The values for AF and ABS were provided above and are in accordance with USEPA and Region IV guidance.

Construction Worker

Dermal contact with subsurface soil COPCs could potentially occur during excavation activities. Skin surface area (SA) used for the construction worker exposure scenario were developed for an individual wear a short-sleeved shirt, long pants, and boots. The exposed skin surface area (4,300 cm²) was limited to the head (1,180 cm²), arms (2,280 cm²), and hands (840 cm²) (USEPA, 1992). The exposure frequency and exposure duration are the same as those discussed for incidental ingestion of subsurface soil. The values for AF and ABS were provided above and are in accordance with USEPA and Region IV guidance.

A summary of the soil exposure assessment input parameters for dermal contact is presented in Table 6-8.

6.3.4.3 Inhalation of Fugitive Particulates

Exposure to fugitive particulates was estimated for future residents, base personnel, trespassers, and future construction workers. These populations may be exposed during daily recreational or work-related activities. The chronic daily intake of contaminants associated with the inhalation of particulates was estimated using the following equation:

$$CDI = \frac{C \times IR \times ET \times EF \times ED \times 1/PEF}{BW \times AT}$$

Where:

C	=	Contaminant concentration in soil (mg/kg)
IR	=	Inhalation rate (m ³ /day)
EF	=	Exposure frequency (days/year)
ED	=	Exposure duration (years)
1/PEF	=	Particulate emission factor (1/1.32x10 ⁹ m ³ /kg)
BW	=	Body weight (kg)
AT	=	Averaging time (days)

The PEF relates the concentration in soil with the concentration of respirable particles in the air from fugitive dust emission. This relationship is derived by Cowherd (1985). The particulate emissions from contaminated sites are caused by wind erosion, and, therefore, depend on erodibility of the surface material. The value of 1.32E+09 m³/kg that is used is obtained from the final Soil Screening Level Guidance to be published by the USEPA in 1996 (USEPA, 1995c).

The following paragraphs discuss the exposure assumptions used in the estimation of exposure to COPCs from the inhalation of particulates.

Military Personnel

During work related activities, military personnel may inhale surface soil COPCs emitted as fugitive dust. An inhalation rate 30 m³/day was used for military personnel (USEPA, 1991). Values for exposure duration, exposure frequency, body weight, and averaging time were the same as those used for the incidental ingestion scenario.

Trespassers

Trespassers may also inhale surface soil particulates. Inhalation rates (IR) used in this exposure scenario were 20 m³/day (USEPA, 1989) and 15 m³/day (USEPA, 1995d) for adults and children, respectively. Exposure frequencies, duration, body weights, and averaging time were the same as those used for the incidental ingestion scenario. Table 6-8 presents the exposure factors used to estimate CDIs associated with the particulate inhalation scenario.

Future On-Site Residents

Future on-site residents may also inhale surface soil particulates. Inhalation rates (IR) used in the on-site resident exposure scenario were 20 m³/day and 15 m³/day for adults and children, respectively. Exposure frequencies, duration, body weights, and averaging time were the same as those used for the incidental ingestion scenario. Table 6-8 presents the exposure factors used to estimate CDIs associated with the particulate inhalation scenario.

Construction Worker

Construction workers could become exposed to subsurface soil particulates during excavation activities. The inhalation rate (IR) used was 20 m³/day (USEPA, 1989). Exposure frequencies, duration, body weight, and averaging time were the same as those used for the soil incidental ingestion scenario. Table 6-8 presents the exposure factors used to estimate CDIs associated with the particulate inhalation scenario.

6.3.4.4 Ingestion of Groundwater

As stated previously, shallow groundwater is not currently being used as a potable supply at Site 43. Development of the shallow aquifer for potable use is unlikely because of its general water quality and poor flow rates. However, residential housing could be constructed in the future and groundwater used for potable purposes.

The CDI of contaminants associated with the future potential consumption of groundwater was estimated using the following general equation:

$$CDI = \frac{C \times IR \times EF \times ED}{BW \times AT}$$

Where:

C	=	Contaminant concentration in groundwater (mg/L)
IR	=	Ingestion rate (L/day)
EF	=	Exposure frequency (days/year)
ED	=	Exposure duration (years)
BW	=	Body weight (kg)
AT	=	Averaging time (days)

The following paragraphs discuss the exposure assumptions used in the estimation of exposure to COPCs from the ingestion of groundwater.

Future On-Site Residents

Exposure to COPCs via ingestion of groundwater was retained as a potential future exposure pathway for both children and adults. An IR of 1.0 L/day was used for the amount of water consumed by a 1 to 6 year old child weighing 15 kg. This ingestion rate provides a conservative exposure estimate for systemic, noncarcinogenic toxicants designed to protect young children who may be more affected than adolescents or adults. This value assumes that children obtain all the tap water they drink from the same source for 350 days/year (which represents the exposure frequency [EF]). An averaging time (AT) of 2,190 days (6 years x 365 days/year) is used for noncarcinogenic compound exposure. The ingestion rate (IR) for adults was 2 liters/day (USEPA, 1989a). The ED used for the estimation of adult CDIs was 30 years (USEPA, 1989), which represents the national upper-bound (90th percentile) time at one residence. The averaging time for noncarcinogens was 10,950 days. An averaging time (AT) of 25,550 days (70 years x 365 days/year) was used to evaluate exposure for both children and adults to potential carcinogenic compounds. Table 6-8 presents a summary of the input parameters for the ingestion of groundwater scenarios.

6.3.4.5 Dermal Contact with Groundwater

The CDI associated with the dermal contact with groundwater was estimated using the following general equation:

$$CDI = \frac{C \times SA \times PC \times ET \times EF \times ED \times CF}{BW \times AT}$$

Where:

C	=	Contaminant concentration in groundwater (mg/L)
SA	=	Surface area available for contact (cm ²)
PC	=	Dermal permeability constant (cm/hr)
ET	=	Exposure time (hour/day)
EF	=	Exposure frequency (days/year)
ED	=	Exposure duration (years)
CF	=	Conversion factor (1 L/1000 cm ³)
BW	=	Body weight (kg)
AT	=	Averaging time (days)

The following paragraphs discuss the exposure assumptions used in the estimation of exposure to COPCs from dermal contact with groundwater.

Future On-Site Residents

Children and adults could contact COPCs through dermal contact with groundwater while bathing or showering. It was assumed that bathing would take place 350 days/year using site groundwater as the sole source. The whole body skin surface area (SA) available for dermal absorption was estimated to be 10,000 cm² for children and 23,000 cm² for adults (USEPA, 1992). The permeability constant (PC) reflects the movement of a chemical across the skin and into the blood stream. The permeability of a chemical is an important property in evaluating actual absorbed dose, yet many compounds do not have literature PC values. For contaminants in which a PC value has not been established, the permeability constant was calculated (see Appendix R). An exposure time (ET) of 0.25 hour/day was used to conservatively estimate the duration of bathing or showering. The exposure duration, body weight, and averaging time were the same as those used for the ingestion of groundwater scenario. Table 6-8 presents the exposure factors used to estimate CDIs associated with the future dermal contact with COPCs in groundwater.

6.3.4.6 Incidental Ingestion of Surface Water

The CDIs for contaminants associated with incidental ingestion of surface water were expressed using the following equation:

$$CDI = \frac{C \times IR \times ET \times EF \times ED}{BW \times AT}$$

Where:

C	=	Contaminant concentration in surface water (mg/L)
IR	=	Ingestion rate (L/day)

ET	=	Exposure time (hours/day)
EF	=	Exposure frequency (days/year)
ED	=	Exposure duration (years)
BW	=	Body weight (kg)
AT	=	Averaging time (days)

The following paragraphs discuss the exposure assumptions used in the estimation of exposure to COPCs from the incidental ingestion of surface water.

Current Trespassers and Future Residents

Adults and children who may potentially come into contact with the surface water were assumed to conservatively ingest surface water at a rate of 0.005 L/hour (USEPA, 1989). In addition, an exposure frequency (EF) of 45 days/year (9 days/month x 5 months), an ET of 2.6 hours/day and an exposure duration (ED) of 6 years (age 1-6) for a child, and 30 years for an adult were used (USEPA, 1989).

A summary of the surface water exposure factors associated with incidental ingestion of surface water is presented in Table 6-8.

6.3.4.7 Dermal Contact with Surface Water

The CDIs of contaminants associated with dermal contact of surface water were determined using the following general equation:

$$CDI = \frac{C \times CF \times SA \times PC \times ET \times EF \times ED}{BW \times AT}$$

Where:

C	=	Contaminant concentration in surface water (mg/L)
CF	=	Conversion factor (0.001L/cm ³)
SA	=	Surface area available for contact (cm ²)
PC	=	Chemical-specific dermal permeability constant (cm/hr)
ET	=	Exposure time (hour/day)
EF	=	Exposure frequency (days/year)
ED	=	Exposure duration (years)
BW	=	Body weight (kg)
AT	=	Averaging time (days)

The following paragraphs discuss the exposure assumptions used in the estimation of exposure to COPCs from dermal contact with surface water.

Current Trespassers and Future Residents

The SA values for adult and child residents who may potentially come into contact with the surface water during wading activities were assumed to be 5,800 cm² and 2,300 cm², respectively. In the case of the adult and child trespasser, the exposed SA values were assumed to be 5,000 cm² and 2,000 cm², respectively. The derivation of these values was previously described in the soil

exposure scenario. In addition, an exposure frequency (EF) of 45 days/year (9 days/month x 5 months) and an exposure duration (ED) of 6 years (age 1-6) for a child, and 30 years for an adult were used (USEPA, 1989). It was conservatively assumed that 2.6 hours/day would be the exposure time for these receptors. The values for PC were chemical-specific. For COPCs with no PC values available, the values were calculated (see Appendix R). The exposure factors for this potential exposure pathway are summarized in Table 6-8.

6.3.4.8 Incidental Ingestion of Sediment

The CDI of COPCs associated with the incidental ingestion of sediment was expressed using the following general equation:

$$CDI = \frac{C \times IR \times ET \times EF \times ED \times CF}{BW \times AT}$$

Where:

C	=	Contaminant concentration in sediment (mg/kg)
CF	=	Conversion factor (1x10 ⁻⁶ kg/mg)
IR	=	Ingestion rate of sediment (mg/day)
EF	=	Exposure frequency (days/year)
ED	=	Exposure duration (years)
BW	=	Body weight (kg)
AT	=	Averaging time (days)

The following paragraphs discuss the exposure assumptions used in the estimation of exposure to COPCs from incidental ingestion of sediments.

Current Trespassers and Future Residents

Incidental ingestion of COPCs in sediments is also possible during activities occurring in the surface water bodies at Site 43, specifically Strawhorn Creek and Edwards Creek. Ingestion rates (IR) of 200 mg/day and 100 mg/day, respectively, were used in calculating the chronic daily intake for children and adults. The exposure frequency (EF) of 45 days/year (9 days/month x 5 months) was used as a conservative site-specific assumption. An exposure duration (ED) of 6 years and 30 years was used in the estimation of potential COPCs for a child and adult, respectively.

A summary of exposure factors for this scenario is presented in Table 6-8.

6.3.4.9 Dermal Contact with Sediment

The CDI of contaminants associated with the dermal contact of affected sediments was expressed using the following general equation:

$$CDI = \frac{C \times CF \times SA \times AF \times ABS \times EF \times ED}{BW \times AT}$$

Where:

C	=	Contaminant concentration in sediment (mg/kg)
CF	=	Conversion factor (1×10^{-6} kg/mg)
SA	=	Surface area available for contact (cm^2/day)
AF	=	Adherence factor ($1.0 \text{ mg}/\text{cm}^2$)
ABS	=	Absorption factor (dimensionless) - 0.01 organics, 0.001 inorganics (USEPA, Region IV, 1992d)
EF	=	Exposure frequency (days/year)
ED	=	Exposure duration (years)
BW	=	Body weight (kg)
AT	=	Averaging time (days)

The following paragraphs discuss the exposure assumptions used in the estimation of exposure to COPCs from dermal contact with sediment.

Current Trespassers and Future Residents

Future on-site residents and current trespassers could also be potentially exposed to COPCs in sediment via dermal contact. As in the surface water exposure scenario, the total body surface area was $5,800 \text{ cm}^2$ for adult residents and $2,300 \text{ cm}^2$ for child residents. Also, the SA values for the adult and child trespassers were assumed to be $5,000 \text{ cm}^2$ and $2,000 \text{ cm}^2$, respectively. Exposure duration, exposure frequencies, body weights, and averaging times were the same as those discussed for the surface water exposure scenario presented previously. The values for AF and ABS were provided with the equation and are in accordance with USEPA and Region IV guidance. Table 6-8 provides a complete summary of the input parameters used in the estimation of CDIs for this scenario.

6.4 Toxicity Assessment

The purpose of this section is to define the toxicological values used to evaluate the exposure to the COPCs identified in Section 6.2. A toxicological evaluation characterizes the inherent toxicity of a compound. It consists of the review of scientific data to determine the nature and extent of the potential human health and environmental effects associated with exposure to various contaminants.

Human data from occupational exposures are often insufficient for determining quantitative indices of toxicity because of uncertainties in exposure estimates and inherent difficulties in determining causal relationships established by epidemiological studies. For this reason, animal bioassays are conducted under controlled conditions and their results are extrapolated to humans. There are several stages to this extrapolation. First, to account for species differences, conversion factors are used to extrapolate from test animals to humans. Second, the relatively high doses administered to test animals must be extrapolated to the lower doses more typical of human exposures. For potential noncarcinogens, safety factors and modifying factors are applied to animal results when developing acceptable human doses. For potential carcinogens, mathematical models are used to extrapolate effects at high doses to effects at lower doses. Epidemiological data can be used for inferential purposes to establish the credibility of the experimentally derived indices.

The available toxicological information indicates that many of the COPCs have both potential carcinogenic and noncarcinogenic health effects in humans and/or experimental animals. Although the COPCs may cause adverse health and environmental impacts, dose-response relationships and

the potential for exposure must be evaluated before the risk to receptors can be determined. Dose-response relationships correlate the magnitude of the dose with the probability of toxic effects, as discussed in the following section.

An important component of the risk assessment is the relationship between the dose of a compound (amount to which an individual or population is potentially exposed) and the potential for adverse health effects resulting from the exposure to that dose. Dose-response relationships provide a means by which potential public health impacts may be evaluated. The published information on doses and responses is used in conjunction with information on the nature and magnitude of exposure to develop an estimate of risk.

Standard carcinogenic slope factors (CSFs) and/or reference doses (RfDs) have been developed for many of the COPCs. This section provides a brief description of these parameters.

6.4.1 Carcinogenic Slope Factor

CSFs are used to estimate an upper-bound lifetime probability of an individual developing cancer as a result of exposure to a particular level of a potential carcinogen (USEPA, 1989). This factor is generally reported in units of $(\text{mg}/\text{kg}/\text{day})^{-1}$ and is derived through an assumed low-dosage linear multistage model and an extrapolation from high to low dose-responses determined from animal studies. The value used in reporting the slope factor is the upper 95th percent confidence limit.

These slope factors are also accompanied by USEPA weight-of-evidence (WOE) classifications, which designate the strength of the evidence that the COPC is a potential human carcinogen.

In assessing the carcinogenic potential of a chemical, the Human Health Assessment Group (HHAG) of USEPA classifies the chemical into one of the following groups, according to the weight of evidence from epidemiologic and animal studies:

- Group A** - **Human Carcinogen** (sufficient evidence of carcinogenicity in humans)
- Group B** - **Probable Human Carcinogen** (B1 - limited evidence of carcinogenicity in humans; B2 - sufficient evidence of carcinogenicity in animals with inadequate or lack of evidence in humans)
- Group C** - **Possible Human Carcinogen** (limited evidence of carcinogenicity in animals and inadequate or lack of human data)
- Group D** - **Not Classifiable as to Human Carcinogenicity** (inadequate or no evidence)
- Group E** - **Evidence of Noncarcinogenicity for Humans** (no evidence of carcinogenicity in adequate studies)

6.4.2 Reference Dose

The RfD is developed for chronic and/or subchronic human exposure to chemicals and is based solely on the noncarcinogenic effects of chemical substances. It is defined as an estimate of a daily exposure level for the human population, including sensitive populations, that is not likely to cause an appreciable risk of adverse effects during a lifetime. The RfD is usually expressed as dose (mg) per unit body weight (kg) per unit time (day). It is generally derived by dividing a

no-observed-(adverse)-effect-level (NOAEL or NOEL) or a lowest observed-adverse-effect-level (LOAEL) for the critical toxic effect by an appropriate uncertainty factor (UF). Effect levels are determined from laboratory or epidemiological studies. The UF is based on the availability of toxicity data.

UFs usually consist of multiples of 10, where each factor represents a specific area of uncertainty naturally present in the extrapolation process. These UFs are presented below and were taken from the Risk Assessment Guidance Document for Superfund, Volume I, Human Health Evaluation Manual (Part A) (USEPA, 1989):

- A UF of 10 is to account for variation in the general population and is intended to protect sensitive populations (e.g., elderly, children).
- A UF of 10 is used when extrapolating from animals to humans. This factor is intended to account for the interspecies variability between humans and other mammals.
- A UF of 10 is used when a NOAEL derived from a subchronic instead of a chronic study is used as the basis for a chronic RfD.
- A UF of 10 is used when a LOAEL is used instead of a NOAEL. This factor is intended to account for the uncertainty associated with extrapolating from LOAELs to NOAELs.

In addition to UFs, a modifying factor (MF) is applied to each reference dose and is defined as:

- A MF ranging from >0 to 10 is included to reflect a qualitative professional assessment of additional uncertainties in the critical study and in the entire data base for the chemical not explicitly addressed by the preceding uncertainty factors. The default for the MF is 1.

Thus, the RfD incorporates the uncertainty of the evidence for chronic human health effects. Even if applicable human data exist, the RfD still maintains a margin of safety so that chronic human health effects are not underestimated.

Toxicity factors and the USEPA WOE classifications are presented in Table 6-10. The hierarchy (USEPA, 1989) for choosing these values was as follows:

- Integrated Risk Information System (IRIS, 1995)
- Health Effects Assessment Summary Table (HEAST, 1995)

The IRIS data base is updated monthly and contains both verified CSFs and RfDs. The USEPA has formed the Carcinogen Risk Assessment Verification Endeavor (CRAVE) Workgroup to review and validate toxicity values used in developing CSFs. Once the slope factors have been verified via extensive peer review, they appear in the IRIS data base. Like the CSF Workgroup, the USEPA has formed a RfD Workgroup to review existing data used to derive RfDs. Once the reference doses has been verified, they also appear in IRIS.

HEAST on the other hand, provides both interim (unverified) and verified CSFs and RFDs. This document is published quarterly and incorporates any applicable changes to its data base.

Toxicity values will be obtained primarily from the Region III Risk-Based Concentration Table, which is based on IRIS, HEAST and provisional and/or recommended USEPA toxicity values, in accordance with Region IV recommendations.

For some chemicals, there are no USEPA-verified toxicity values (i.e., RfDs and CSFs) available for risk quantitation. This is the case for lead. The following section provides a discussion of how lead health effects were quantified for this assessment.

For other chemicals, the toxicity values of similarly structured compounds were substituted. For this site, the chemical substitutes were as follows: naphthalene for 2-methylnaphthalene, pyrene for benzo(g,h,i)perylene, phenanthrene, and acenaphthylene, and chlordane for alpha-chlordane and gamma-chlordane. In addition, there are some chemicals with different toxicity values associated with the medium in which they are detected. For example, the oral RfD for cadmium differs when found in food or water. Consequently, the oral RfD associated with food was applied for assessing soil exposure, and the oral RfD associated with water was used accordingly.

6.4.3 Lead

Lead was identified as a COPC in the surface water and sediment at Site 43. Currently, health-based criteria are not available for evaluating either the noncarcinogenic or carcinogenic effects of lead exposure. The USEPA has not developed health-based criteria because a threshold level for many noncancer health effects has not been identified in infants and younger children (i.e., the most sensitive populations). In addition, the USEPA's lead uptake/biokinetic (UBK) model, which utilizes site-specific exposure parameters to estimate blood lead levels in infants and young children, does not consider surface water/sediment concentrations when calculating lead exposures. Consequently, risk from lead exposure was not calculated for the site.

6.4.4 Dermal Adjustment of Toxicity Factors

Because there are few toxicity reference values for dermal exposure, oral values are frequently used to assess risk from dermal exposure. Most RfDs and some slope factors are expressed as the amount of substance administered per unit time and unit body weight, while exposure estimates for the dermal route are expressed as absorbed dose. Consequently, it may be necessary to adjust an oral toxicity value from an administered dose to an absorbed dose.

Region IV provides absorption efficiency values for each class of chemicals. They are as follows:

VOCs	=	0.80
SVOCs	=	0.50
Inorganics	=	0.20
Pesticides/PCBs	=	0.50

An adjusted oral RfD is the product of the absorption efficiency and the oral toxicity reference value. The adjusted oral CSF is the ratio of the oral toxicity value and the absorption efficiency. Table 6-11 presents a summary of the dermally-adjusted toxicity values used in this BRA.

6.5 Risk Characterization

This section presents and discusses the estimated incremental lifetime cancer risks (ICRs) and hazard indices (HIs) for identified potential receptor groups which could be exposed to COPCs via the exposure pathways presented in Section 6.3.

These quantitative risk calculations for potentially carcinogenic compounds estimate ICRs levels for an individual in a specified population. This unit risk refers to the cancer risk that is over and above the background cancer risk in unexposed individuals. For example, an ICR of 1×10^{-6} indicates that, for a lifetime exposure, one additional case of cancer may occur per one million exposed individuals.

The ICR to individuals was estimated from the following relationship:

$$ICR = \sum_{i=1}^n CDI_i \times CSF_i$$

where CDI_i is the chronic daily intake (mg/kg/day) for compound i and CSF_i is the cancer slope in (mg/kg/day) $^{-1}$ for contaminant i . The CSF is defined in most instances as an upper 95th percentile confidence limit of the probability of a carcinogenic response based on experimental animal data, and the CDI is defined as the exposure expressed as a mass of a substance contracted per unit body weight per unit time, averaged over a period of time (i.e., six years to a lifetime). The above equation was derived assuming that cancer is a non-threshold process and that the potential excess risk level is proportional to the cumulative intake over a lifetime.

In contrast to the above approach for potentially carcinogenic effects, quantitative risk calculations for noncarcinogenic compounds assume that a threshold toxicological effect exists. Therefore, the potential for noncarcinogenic effects is calculated by comparing CDIs with threshold levels (reference doses).

Noncarcinogenic effects were estimated by calculating the hazard index (HI) which is defined as:

$$HI = HQ_1 + HQ_2 + \dots + HQ_n \text{ or}$$

$$HI = \sum_{i=1}^n HQ_i$$

$$\text{where } HQ_i = CDI_i / RfD_i$$

HQ_i is the hazard quotient for contaminant i , CDI_i is the chronic daily intake (mg/kg/day) of contaminant i , and RfD_i is the reference dose (mg/kg/day) of the contaminant i over a prolonged period of exposure.

6.5.1 Human Health Risks

The following paragraphs present the quantitative results of the human health evaluation for each medium and area of concern at Site 43.

Estimated ICRs were compared to the target risk range of 1×10^{-6} to 1×10^{-4} . A value of 1.0 was used for examination of the HI. The HI was calculated by comparing estimated CDIs with threshold levels below which, noncarcinogenic health effects are not expected to occur. Any HI equal to or exceeding 1.0 suggested that noncarcinogenic health effects were possible. If the HI was less than 1.0, then systemic human health effects were considered unlikely. Tables 6-12 through 6-17 present these risk results.

6.5.1.1 Current Military Personnel

The current military receptor was evaluated for potential noncarcinogenic and carcinogenic risk from exposure to the surface soil. The noncarcinogenic (i.e., $HI=0.03$) and carcinogenic risks (i.e., $ICR=1.8 \times 10^{-6}$) fell below USEPA's acceptable risk levels (i.e., $HI < 1$ and $1 \times 10^{-6} < ICR < 1 \times 10^{-4}$). These results are presented in Table 6-12.

6.5.1.2 Current Trespasser Child

In the current scenario, a recreational child receptor was evaluated for potential risk from exposure to site surface soils and surface water and sediment from Strawhorn and Edwards Creek. The potential noncarcinogenic and carcinogenic risks from exposure to the surface soil (i.e., $HI=0.06$ and $ICR=4.9 \times 10^{-6}$), surface water (i.e., $HI=0.01$ and $ICR=3.8 \times 10^{-6}$), and sediment (i.e., $HI=0.3$ and $ICR=5.2 \times 10^{-6}$) were within acceptable risk levels (i.e., $HI < 1$ and $1 \times 10^{-6} < ICR < 1 \times 10^{-4}$). These results are presented in Table 6-13.

6.5.1.3 Future Residential Child

The child receptor was evaluated for potential risk from exposure to surface soil and groundwater in the future scenario. It was assumed that current exposure to surface water and sediment also would occur in the future case.

The potential noncarcinogenic and carcinogenic risks from exposure to the surface soil (i.e., $HI=0.33$ and $ICR=2.3 \times 10^{-5}$), the surface water (i.e., $HI=0.01$ and $ICR=5.4 \times 10^{-7}$) and sediment (i.e., $HI=0.25$ and $ICR=5.3 \times 10^{-6}$) were within acceptable risk levels (i.e., $HI < 1$ and $1 \times 10^{-6} < ICR < 1 \times 10^{-4}$). The results are summarized in Table 6-14.

In groundwater, there is a potential noncarcinogenic risk from ingestion for the child receptor. The total noncarcinogenic risk level of 9.5 was due primarily to groundwater ingestion. The noncarcinogenic risk value for groundwater ingestion was 8.9. Iron and aluminum in groundwater contributed to this risk. It should be noted that iron was selected as a COPC in all media sampled at Site 43. Aluminum was selected as a COPC in all media except subsurface soil. Since there were no potential carcinogens retained as COPCs in groundwater, a carcinogenic risk does not apply to this case. The risk results are presented in Table 6-14.

6.5.1.4 Current Trespasser Adult

In the current scenario, an adult trespasser was evaluated for potential risk from exposure to site surface soils (i.e., $HI < 0.01$ and $ICR=1.9 \times 10^{-6}$) and surface water (i.e., $HI < 0.01$ and $ICR=1.0 \times 10^{-5}$), and sediment (i.e., $HI=0.03$ and $ICR=4.3 \times 10^{-6}$). The potential noncarcinogenic and carcinogenic risks from exposure to these media were within acceptable risk levels (i.e., $HI < 1$ and $1 \times 10^{-6} < ICR < 1 \times 10^{-4}$). These results are provided in Table 6-15.

6.5.1.5 Future Residential Adult

The adult receptor was evaluated for potential risk from exposure to surface soil and groundwater in the future scenario. Similar to the child receptor, it was assumed that current exposure to the surface water and sediment also would occur in the future case.

In surface soil (i.e., HI=0.04 and ICR=2.2x10⁻⁵), surface water (i.e., HI<0.01 and ICR=1.4 x 10⁻⁶), and sediment (i.e., HI=0.03 and ICR=4.6x10⁻⁶), the potential noncarcinogenic and carcinogenic risks from exposure to these media were within acceptable levels (i.e., HI<1 and 1x10⁻⁶<ICR<1x10⁻⁴). Table 6-16 summarizes these results.

In groundwater, there is a potential noncarcinogenic risk from ingestion for the adult receptor. The total noncarcinogenic risk level of 3.9 was due primarily to groundwater ingestion. The noncarcinogenic risk value for groundwater ingestion was 3.8. Iron and aluminum in groundwater contributed to this risk. It should be noted that iron was selected as a COPC in all media sampled at Site 43. Aluminum was selected as a COPC in all media except subsurface soil. Since there were no potential carcinogens retained as COPCs in groundwater, a carcinogenic risk does not apply to this case. The risk results are presented in Table 6-16.

6.5.1.6 Construction Worker

The construction worker was evaluated for potential noncarcinogenic and carcinogenic risk from exposure to subsurface soil in the future case. The noncarcinogenic and carcinogenic risks (i.e., HI=0.01 and ICR=9.0x10⁻⁸) from exposure to the subsurface soil fell within the acceptable risk range of 1x10⁻⁶<ICR<1x10⁻⁴. Table 6-17 presents these results.

6.6 Sources of Uncertainty

Uncertainties may be encountered throughout the BRA process. This section discusses the sources of uncertainty involved with the following:

- Analytical data
- Exposure Assessment
- Toxicity Assessment
- Compounds Not Qualitatively Evaluated

In addition, the USEPA stresses the importance of recognizing the unique characteristics and circumstances of each facility and the need to formulate site-specific responses. However, many of the assumptions presented in this document were derived from USEPA guidance, which is designed to provide a conservative approach and cover a broad variety of cases. As such, the generic application of such assumptions to a site in the RME case scenario may work against the objective of formulating a site-specific response to a constituent presence (i.e., it is possible that the site risks may be overestimated).

The following sections provide a discussion of the sources of uncertainty associated with this BRA and the effects on total site risk.

6.6.1 Analytical Data

The development of a BRA depends on the reliability of and uncertainties with the analytical data available to the risk assessor. Analytical data are limited by the precision and accuracy of the analytical method of analysis. In addition, the statistical methods used to compile and analyze the data (mean concentration, standard deviation, and detection frequencies) are subject to the uncertainty in the ability to acquire data.

Data validation serves to reduce some of the inherent uncertainty associated with the analytical data by establishing the usability of the data to the risk assessor who may or may not choose to include the data point in the estimation of risk. Data qualified as "J" (estimated) were retained for the estimation of risk at OU No. 6. Data can be qualified as estimated for many reasons including a slight exceedance of holding times, high or low surrogate recovery, or intra sample variability. Organic data qualified "B" (detected in blank) were not used in the estimation of risk because these levels were attributed to blank contamination. Data qualified with an "R" (unreliable) were not used in the estimation of risk due to the unusable nature of the data. A brief discussion of the data quality is provided in Section 4.0. Due to the comprehensive sampling and analytical program at OU No. 6, the loss of some data points qualified "B" or "R" did not significantly increase the uncertainty in the estimation of risk.

6.6.2 Exposure Assessment

In performing exposure assessments, uncertainties can arise from two main sources. First, the chemical concentration to which a receptor may be exposed must be estimated for every medium of interest. Second, uncertainties can arise in the estimation of contaminant intakes resulting from contact by a receptor with a particular medium.

Estimating the contaminant concentration in a given medium to which a human receptor could potentially be exposed can be as simple as deriving the 95th percent upper confidence limit of the mean for a data set. More complex methods of deriving the contaminant concentration are necessary when exposure to COPCs in a given medium occurs subsequent to release from another medium, or when analytical data are not available to characterize the release. In this case, modeling is usually employed to estimate the potential human exposure.

The potential inhalation of fugitive dusts from affected soils was estimated in the BRA using USEPA's Rapid Assessment of Exposure to Particulate Emissions from Surface Contaminated Sites (Cowherd et al. 1985). The Cowherd model employs the use of a default PEF for wind erosion based on source area and vegetative cover. A conservative estimate of the PEF was used for Site 43 by assuming a 0.5 acre source area with 50% erosion potential (USEPA, 1995c). Modeling results for fugitive dust emission exposure suggested that the potential risk associated with this pathway was not significant.

Groundwater samples were analyzed for total (unfiltered) and dissolved (filtered) inorganic contaminants. These samples were obtained from wells which were constructed using USEPA Region IV monitoring well design specifications. Groundwater taken from monitoring wells cannot be considered representative of potable groundwater or groundwater which is obtained from a domestic well "at the tap". The use of total inorganic analytical results overestimates the potential human health risks associated with potable use scenarios. However, for the sake of conservatism, total organic results were used to estimate the potential intake associated with groundwater use.

Currently, the shallow groundwater is not used as a potable source. Current receptors (military personnel, military dependents, and civilian base personnel) are exposed via ingestion, dermal contact, and inhalation to groundwater drawn from the deep zone. Therefore, assessing current risks to contaminants detected in the shallow aquifer for current receptors is unnecessary and, if estimated, may present an unlikely risk. Therefore, groundwater exposure to current receptors was not estimated for this investigation.

As stated previously, both the shallow and deep groundwater analytical results were combined and evaluated as single data set for the risk evaluation. It is important to note that the shallow groundwater is not currently used for potable purposes at the site. In addition, it is highly unlikely that this groundwater will be used similarly in the future. However, because it was determined (see Section 2.0 of this report) that the shallow and deep groundwater systems are interconnected, the data were combined and evaluated as a single set for the risk assessment. Use of this combined data set lends a certain degree of uncertainty to the risks calculated for groundwater exposure.

To estimate an intake, certain assumptions must be made about exposure events, exposure durations, and the corresponding assimilation of contaminants by the receptor. Exposure factors, have been generated by the scientific community and have undergone review by the USEPA. Regardless of the validity of these exposure factors, they have been derived from a range of values generated by studies of limited number of individuals. In all instances, values used in the risk assessment, scientific judgments, and conservative assumptions agree with those of the USEPA. Conservative assumptions designed not to underestimate daily intakes were employed throughout the BRA and should error conservatively, thus adequately protecting human health and allowing the establishment of reasonable clean-up goals.

6.6.3 Sampling Strategy

Soil represents a medium of direct contact exposure and often is the main source of contaminants released into other media. The soil sampling depth should be applicable for the exposure pathways and contaminant transport routes of concern and should be chosen purposely within that depth interval. If a depth interval is chosen purposely, a random sample procedure to select a sampling point may be established. The assessment of surface exposure at the site is certain based on collection of samples from the shallowest depth, zero to one foot. Subsurface soil samples are important, however, if soil disturbance is likely or leaching of chemicals to groundwater is of concern.

In the future exposure scenarios, subsurface soil exposure was evaluated. It was assumed that the subsurface soil would be excavated and used as surface grading, landscaping, etc., in the foreseeable future. It is important to note that many of these subsurface soil samples were collected at depths ranging from 1 foot to possibly up to 20 feet, depending on the depth of the well from which the soil boring was collected. It may be unrealistic to assume that excavation could occur at such depths. It follows that exposure to contaminants in soil at these depths would be unlikely for future receptors. However, for the BRA, the subsurface soil analytical results were not segregated by depth, but were evaluated as a single data set. Consequently, levels found at all depths were evaluated for potential risk to human health. The use of the entire subsurface soil data set may add to the conservative nature of the approach used to assess risk for this site.

The surface soil samples at all sites were obtained directly or very near the suspected disposal areas. Therefore, these areas would be considered areas of very high concentration which would have a significant impact on exposures.

6.6.4 Toxicity Assessment

In making quantitative estimates of the toxicity of varying doses of a compound to human receptors, uncertainties arise from two sources. First, data on human exposure and the subsequent effects are usually insufficient, if they are available at all. Human exposure data usually lack adequate concentration estimations and suffer from inherent temporal variability. Therefore, animal studies are often used; and, therefore, new uncertainties arise from the process of extrapolating animal results to humans. Second, to obtain observable effects with a manageable number of experimental animals, high doses of a compound are used over a relatively short time period. In this situation, a high dose means that experimental animal exposures are much greater than human environmental exposures. Therefore, when applying the results of the animal experiment to humans, the effects at the high doses must be extrapolated to approximate effects at lower doses.

In extrapolating effects from animals to humans and high doses to low doses, scientific judgment and conservative assumptions are employed. In selecting animal studies for use in dose-response calculations, the following factors are considered:

- Studies are preferred where the animal closely mimics human pharmacokinetics
- Studies are preferred where dose intake most closely mimics the intake route and duration for humans
- Studies are preferred which demonstrate the most sensitive response to the compound in question

For compounds believed to cause threshold effects (i.e., noncarcinogens), safety factors are employed in the extrapolation of effects from animals to humans and from high to low doses.

Conservatism is also introduced through the use of experimentally-derived oral absorption efficiencies to adjust oral toxicity criteria (i.e., CSFs and RfDs), derived during studies based on administered dosages, for the estimation of dermal absorption. Equating the absorption efficiency of the bi-phasic dermal barrier to that of the mono-phasic gastrointestinal lining and then applying it to oral toxicity criteria in a dermal risk assessment scenario tends to generally overestimate the potential risk to human health by no more than an order of magnitude.

The use of conservative assumptions results in quantitative indices of toxicity that are not expected to underestimate potential toxic effects, but may overestimate these effects by an order of magnitude or more.

6.7 Conclusions of the BRA for Site 43

The BRA highlights the media of interest from the standpoint of human health at Site 43 by identifying areas with risk values greater than acceptable levels. Current and future potential receptors at the site included current military personnel, current trespassers (i.e., children and adults), future residents (i.e., children and adults), and future construction workers. The total risk

from the site for these receptors was estimated by logically summing the multiple pathways likely to affect the receptor during a given activity. Exposure to surface soil, surface water and sediment was assessed for the current receptors. Surface soil, groundwater, surface water, and sediment exposure were evaluated for the future residents. Subsurface soil exposure was evaluated for the future construction worker.

6.7.1 Current Scenario

In the current case, the following receptors were assessed: military personnel and adult and child trespassers. Receptor exposure to surface soil, surface water and sediment at Site 43 was examined. The risks calculated for all exposure pathways and receptors were within acceptable risk ranges.

6.7.2 Future Scenario

In the future case, child and adult residents were assessed for potential exposure to groundwater, surface soil, surface water, and sediment. A construction worker was evaluated for subsurface soil exposure. The potential noncarcinogenic and carcinogenic risks for the construction worker at Site 43 were within acceptable levels. The noncarcinogenic risk from groundwater ingestion for the future child resident was 8.9. The noncarcinogenic risk from groundwater ingestion for the future adult resident was 3.9. These values exceed the acceptable risk value of one.

The iron constitutes 82% of both elevated risk values, while aluminum contributes 18%. Without iron as a COPC, the noncarcinogenic risk values for future residential adults and children would be 0.69 and 1.6, respectively. The studies that prompted the addition of a RBC value for iron are provisional only and have not undergone formal review by the USEPA. Also, iron is considered an essential nutrient.

Finally, it should be noted that groundwater in the MCB, Camp Lejeune area is naturally rich in iron. There is no record of any historical use of iron or aluminum at Site 43 although buried construction debris is scattered throughout the site. It is not likely, however, that these analytes are leaching out of this debris given the fact that the pH of the soil and groundwater are not acidic enough to leach metals. Consequently, it is assumed that iron and aluminum are naturally occurring inorganic analytes in groundwater, and their presence is not attributable to site operations. Tables 6-14 and Table 6-16 present these values.

6.8 References

Cowherd, 1985. Cowherd, C., et al. Rapid Assessment of Exposure to Particulate Emissions from Surface Contamination. Prepared for EPA Office of Health and Environmental Assessment. EPA/600/8-85/002.

Foster, 1986. Foster, S.A. and P.C. Chrostowski. "Integrated Household Exposure Model for Use of Tap Water Contaminated with Volatile Organic Chemicals." Presented at the 79th Annual Meeting of the Air Pollution Control Association, Minneapolis, Minnesota. June 22-27, 1986.

USEPA, 1989. U.S. Environmental Protection Agency. Risk Assessment Guidance for Superfund Volume I. Human Health Evaluation Manual (Part A) Interim Final. Office of Solid Waste and Emergency Response. Washington, D.C. EPA/540/1-89-002. December 1989.

USEPA, 1989a. U.S. Environmental Protection Agency. Risk Assessment Guidance for Superfund Volume II. Environmental Evaluation Manual Interim Final. Office of Solid Waste and Emergency Response. Washington, D.C. EPA/540/1-89-001. May 1989.

USEPA, 1989b. U.S. Environmental Protection Agency. Exposure Factors Handbook. July 1989.

USEPA, 1990. U.S. Protection Agency. National Oil and Hazardous Substances Pollution Contingency Plan. 55FR8665. Office of Emergency and Remedial Response. Washington, D.C. March 1990.

USEPA, 1991. U.S. Environmental Protection Agency. Risk Assessment Guidance for Superfund Volume I. Human Health Evaluation Manual Supplemental Guidance. "Standard Default Exposure Factors" Interim Final. Office of Solid Waste and Emergency Response. Washington, D.C. OSWER Directive 9285.6-03. March 25, 1991.

USEPA, 1991a. U.S. Environmental Protection Agency. June 1991. National Functional Guidelines for Organic Data Review. Draft. USEPA Contract Laboratory Program.

USEPA, 1992. U.S. Environmental Protection Agency. Dermal Exposure Assessment: Principles and Applications. Interim Report. Office of Health and Environmental Assessment. Washington, D.C. EPA/600/8-91/011B. January 1992.

USEPA, 1992a. U.S. Environmental Protection Agency. New Interim Region IV Guidance for Toxicity Equivalency Factor (TEF) Methodology. Region IV Water Management Division.

USEPA, 1992b. U.S. Environmental Protection Agency. Supplemental Guidance to RAGS: Calculating the Concentration Term. Office of Solid Waste and Emergency Response. Washington, D.C., Publication 9285.7-081. May 1992.

USEPA, 1992c. U.S. Environmental Protection Agency. Region IV Waste Management Division Screening Values for Hazardous Waste Sites. Region IV, Atlanta Georgia. January 1992.

USEPA, 1992d. USEPA Region IV Supplemental Risk Guidance. February 11, 1992.

USEPA, 1993. U.S. Environmental Protection Agency. Region IV Waste Management Division Screening Values for Hazardous Waste Sites. Region IV, Atlanta Georgia. January 1993.

USEPA. 1995. U.S. Environmental Protection Agency. Health Effects Assessment Summary Tables Annual FY-1995. Office of Solid Waste and Emergency Response. Washington, D.C. EPA/540/R-95/036 PB95-921199. May 1995.

USEPA, 1995a. U.S. Environmental Protection Agency. Integrated Risk Information System (IRIS). Environmental Criteria and Assessment Office, Cincinnati, Ohio.

USEPA, 1995b. U.S. Environmental Protection Agency. Region III Risk-Based Concentration Table. Philadelphia, Pennsylvania. October, 1995.

USEPA, 1995c. U. S. Environmental Protection Agency. Phone conversation with Janine Dinan. Washington, D.C. November 17, 1995.

USEPA, 1995d. U. S. Environmental Protection Agency. Region IV Supplemental Guidance to RAGS. Human Health Risk Assessment Bulletin No. 3. Region IV, Atlanta, Georgia. November, 1995.

Water and Air Research, Inc. (WAR). 1983. Initial Assessment Study of Marine Corps Base Camp Lejeune, North Carolina. Prepared for Naval Energy and Environmental Support Activity.

SECTION 6.0 TABLES

TABLE 6-1

**CONTAMINANTS OF POTENTIAL CONCERN
ORGANICS IN SURFACE SOIL
SITE 43-AGAN STREET DUMP
REMEDIAL INVESTIGATION, CTO-0303
MCB, CAMP LEJEUNE, NORTH CAROLINA**

Contaminant	Minimum Value (µg/kg)	Maximum Value (µg/kg)	95% UCL of Lognormal Distribution (µg/kg)	Location of Maximum Detected Value	Frequency of Detection	Frequency Percentage (%)	Region III Residential Soil Screening Value (µg/kg)	Screening Value Exceedance Frequency
Semivolatiles:								
4-Methylphenol	120J	120J	218.38	43-DA1-SB02-00	1/28	4%	39,000	0/28
2-Methylnaphthalene	74J	74J	225.77	43-WA-SB01A-00	1/28	4%	310,000	0/28
Acenaphthylene ⁽¹⁾	71J	71J	227.32	43-WA-SB01A3-00	1/28	4%	230,000	0/28
Acenaphthene	45J	2,900	340.40	43-WA-SB01A-00	3/28	11%	470,000	0/28
Dibenzofuran	35J	870	275.82	43-WA-SB01A-00	2/28	7%	31,000	0/28
Fluorene	53J	1,700	302.99	43-WA-SB01A-00	3/28	11%	310,000	0/28
Phenanthrene ⁽¹⁾	54J	5,900J	614.75	43-WA-SB01A-00	8/28	29%	230,000	0/28
Anthracene	44J	820	269.31	43-WA-SB01A-00	3/28	11%	2,300,000	0/28
Carbazole	99J	350J	239.26	43-WA-SB01A-00	5/28	18%	32,000	0/28
Fluoranthene	49J	60,000	2308.52	43-WA-SB01A-00	10/28	36%	310,000	0/28
Pyrene	49J	64,000	2234.99	43-WA-SB01A-00	10/28	36%	230,000	0/28
Butylbenzylphthalate	50J	420J	243.19	43-OA-SB03-00	3/28	11%	1,600,000	0/28
Benzo(a)anthracene	51J	41,000	1237.87	43-WA-SB01A-00	9/28	32%	880	3/28
Chrysene	110J	46,000	1497.89	43-WA-SB01A-00	9/28	32%	88,000	0/28
Bis(2-ethylhexyl)phthalate	43J	430J	250.27	43-OA-SB03-00	10/28	36%	46,000	0/28
Benzo(b)fluoranthene	44J	52,000	2284.88	43-WA-SB01A-00	10/28	36%	880	5/28
Benzo(k)fluoranthene	57J	20,000	767.85	43-WA-SB01A-00	9/28	32%	8,800	1/28
Benzo(a)pyrene	79J	39,000	1450.26	43-WA-SB01A-00	9/28	32%	88	8/28
Indeno(1,2,3-cd)pyrene	42J	27,000	1249.54	43-WA-SB01A-00	10/28	36%	880	3/28
Dibenzo(a,h)anthracene	47J	1,200	313.44	43-WA-SB01A-00	8/28	29%	88	6/28
Benzo(g,h,i)perylene ⁽¹⁾	87J	24,000	1073.10	43-WA-SB01A-00	9/28	32%	230,000	0/28

TABLE 6-1 (Continued)

CONTAMINANTS OF POTENTIAL CONCERN
 ORGANICS IN SURFACE SOIL
 SITE 43-AGAN STREET DUMP
 REMEDIAL INVESTIGATION CTO-0303
 MCB, CAMP LEJEUNE, NORTH CAROLINA

Contaminant	Minimum Value (µg/kg)	Maximum Value (µg/kg)	95% UCL of Lognormal Distribution (µg/kg)	Location of Maximum Detected Value	Frequency of Detection	Frequency Percentage (%)	Region III Residential Soil Screening Value (µg/kg)	Screening Value Exceedance Frequency
Pesticides:								
Heptachlor epoxide	2J	2J	1.60	43-WA-SB01-00	1/7	14%	70	0/7
4,4'-DDE	5.7J	1,000J	188000.36	43-DA1-SB03-00	5/7	71%	1,900	0/7
4,4'-DDD	3,000	3,000	16662146.43	43-DA1-SB03-00	1/7	14%	2,700	1/7
4,4'-DDT	10	1,000J	324094.73	43-DA1-SB03-00	4/7	57%	1,900	0/7
Endrin aldehyde	5.4J	5.4J	3.74	43-DA2-SB01-00	1/7	14%	2,300	0/7

Notes:

COPCs are indicated by the shaded areas.

⁽¹⁾ USEPA Region III COC screening value for pyrene used as a surrogate.

TABLE 6-2

**CONTAMINANTS OF POTENTIAL CONCERN
INORGANICS IN SURFACE SOIL
SITE 43-AGAN STREET DUMP
REMEDIAL INVESTIGATION, CTO-0303
MCB, CAMP LEJEUNE, NORTH CAROLINA**

Parameter	Minimum Value (mg/kg)	Maximum Value (mg/kg)	95% UCL of Lognormal Distribution (mg/kg)	Location of Maximum Detected Value	Frequency of Detection	Frequency Percentage (%)	2X Base Background (mg/kg)	Region III Residential Soil Screening Value (mg/kg)	Screening Value Exceedance Frequency
Aluminum	1,060J	8,890	4488.23	43-MA-SB03-00	21/21	100%	5,940.59	7,800	2/21
Arsenic	0.33	1.1	0.70	43-0A-SB06-00	13/21	62%	1.31	0.43	11/21
Barium	3.2	551	45.46	43-WA-SB02-00	21/21	100%	17.36	550	1/21
Cadmium	0.74	1.7	0.50	43-WA-SB02-00	2/21	10%	0.688	3.9	0/21
Calcium	94.6	39,600	159904.26	43-0A-SB06-00	20/21	95%	1,396.79	--	NA
Chromium	1.1	106	23.85	43-DA1-SB02-00	21/21	100%	6.69	39	2/21
Cobalt	0.78	4.1	1.17	43-DA2-SB01-00	5/21	24%	1.92	470	0/21
Copper	0.47	55.7	15.87	43-DA2-SB01-00	17/21	81%	7.2	310	0/21
Iron	844	21,100	4342.87	43-DA2-SB01-00	21/21	100%	3,755.06	2,300	7/21
Lead	4.3	246	67.84	43-DA2-SB01-00	20/21	95%	23.75	400	0/21
Magnesium	44.5	614	302.62	43-0A-SB06-00	21/21	100%	205.75	--	NA
Manganese	2.8	189	36.45	43-DA2-SB01-00	21/21	100%	18.5	1,100 ⁽¹⁾	0/21
Mercury	0.12	0.51	0.11	43-DA1-SB02-00	3/21	14%	0.094	2.3	0/21
Nickel	1.1	5	2.21	43-DA2-SB01-00	8/21	38%	3.43	160	0/21
Potassium	67.4	171	104.37	43-MA-SB03-00	5/21	24%	199.61	--	NA
Selenium	0.36	0.61J	0.27	43-DA2-SB01-00	3/21	14%	0.746	39	0/21
Sodium	12.3	89.8	47.39	43-0A-SB06-00	14/21	67%	59.298	--	NA
Vanadium	3.1	17.3	9.13	43-MA-SB03-00	21/21	100%	11.63	55	0/21
Zinc	1.5	595	283.03	43-DA1-SB02-00	21/21	100%	13.88	2,300	0/21

Notes:

COPCs are indicated by the shaded areas.

⁽¹⁾ Screening value based on a RfD of 0.14 mg/kg/day.

TABLE 6-3

**CONTAMINANTS OF POTENTIAL CONCERN
ORGANICS IN SUBSURFACE SOIL
SITE 43-AGAN STREET DUMP
REMEDIAL INVESTIGATION, CTO-0303
MCB, CAMP LEJEUNE, NORTH CAROLINA**

Contaminant	Minimum Value (µg/kg)	Maximum Value (µg/kg)	95% UCL of Lognormal Distribution (µg/kg)	Location of Maximum Detected Value	Frequency of Detection	Frequency Percentage (%)	Region III Residential Soil Screening Value (µg/kg)	Screening Value Exceedance Frequency
Semivolatiles:								
Phenanthrene ⁽¹⁾	430	430	223.64	43-WA-SB02-01	1/20	5%	230,000	0/20
Carbazole	73J	73J	211.40	43-WA-SB02-01	1/20	5%	32,000	0/20
Fluoranthene	850	850	259.10	43-WA-SB02-01	1/20	5%	310,000	0/20
Pyrene	1800J	1800J	314.40	43-WA-SB02-01	1/20	5%	230,000	0/20
Butylbenzylphthalate	39J	440	250.14	43-OA-SB03-01	2/20	10%	1,600,000	0/20
Benzo(a)anthracene	390J	390J	219.78	43-WA-SB02-01	1/20	5%	880	0/20
Chrysene	740J	740J	249.84	43-WA-SB02-01	1/20	5%	88,000	0/20
Bis(2-ethylhexyl)phthalate	180J	530	232.49	43-OA-SB03-01	2/20	10%	46,000	0/20
Benzo(b)fluoranthene	780	780	254.22	43-WA-SB02-01	1/20	5%	880	0/20
Benzo(k)fluoranthene	340J	340J	214.66	43-WA-SB02-01	1/20	5%	8,800	0/20
Benzo(a)pyrene	570	570	236.78	43-WA-SB02-01	1/20	5%	88	1/20
Indeno(1,2,3-cd)pyrene	890	890	261.80	43-WA-SB02-01	1/20	5%	880	1/20
Dibenzo(a,h)anthracene	170J	170J	198.78	43-WA-SB02-01	1/20	5%	88	1/20
Benzo(g,h,i)perylene ⁽¹⁾	790	790	254.93	43-WA-SB02-01	1/20	5%	230,000	0/20
Pesticides:								
4,4'-DDE	9.1J	9.1J	5.45	43-DA1-SB03-01	1/7	14%	1,900	0/7
4,4'-DDD	1,200	1,200	356,441.82	43-DA1-SB03-01	1/7	14%	2,700	0/7
4,4'-DDT	45J	45J	52.54	43-DA1-SB03-01	1/7	14%	1,900	0/7

Notes:

COPCs are indicated by the shaded areas.

⁽¹⁾ USEPA Region III COC screening value for pyrene used as a surrogate.

TABLE 6-4

**CONTAMINANTS OF POTENTIAL CONCERN
INORGANICS IN SUBSURFACE SOIL
SITE 43-AGAN STREET DUMP
REMEDIAL INVESTIGATION, CTO-0303
MCB, CAMP LEJEUNE, NORTH CAROLINA**

Parameter	Minimum Value (mg/kg)	Maximum Value (mg/kg)	95% UCL of Lognormal Distribution (mg/kg)	Location of Maximum Detected Value	Frequency of Detection	Frequency Percentage (%)	2X Base Background (mg/kg)	Region III Residential Soil Screening Value (mg/kg)	Screening Value Exceedance Frequency
Aluminum	513	5660	4137.23	43-MA-SB03-01	20/20	100%	7,375.30	7800	0/20
Arsenic	0.3J	0.55J	0.28	43-MA-SB01-01	5/20	25%	1.97	0.43	2/20
Barium	2.9	11.7	8.87	43-MA-SB02-02	18/20	90%	14.20	550	0/20
Calcium	17	495	319.41	43-WA-SB02-01	20/20	100%	391.51	--	NA
Chromium	1.1	7.2	5.20	43-MA-SB03-01	19/20	95%	12.56	39	0/20
Cobalt	0.62	0.84	0.38	43-WA-SB02-01	2/20	10%	1.50	470	0/20
Copper	0.4	3.6	0.73	43-OA-SB01-01	6/20	30%	2.42	310	0/20
Iron	317	6,680	2298.37	43-DA1-SB03-01	20/20	100%	7,252.08	2,300	4/20
Lead	1.5	7.5	5.01	43-OA-SB01-01	20/20	100%	8.33	400	0/20
Magnesium	22.1	197	129.99	43-MA-SB04-01	19/20	95%	260.72	--	NA
Manganese	1.6	5.4J	3.90	43-MA-SB04-01	16/20	80%	7.92	1,100 ⁽¹⁾	0/20
Nickel	0.92	2.2	1.33	43-OA-SB06-02	3/20	15%	3.71	160	0/20
Potassium	53.7	185	107.21	43-DA1-SB01-01	5/20	25%	347.24	--	NA
Selenium	0.29	0.29	0.18	43-OA-SB01-01	1/20	5%	0.80	39	0/20
Sodium	6.4	44.4	25.16	43-DA1-SB01-01	10/20	50%	52.68	--	NA
Vanadium	0.74	10	7.37	43-DA1-SB03-01	15/20	75%	13.45	55	0/20
Zinc	1.3	3.7	2.33	43-OA-SB01-01	15/20	75%	6.66	2,300	0/20

Notes:

COPCs are indicated by shaded areas.

⁽¹⁾ Screening value based on a RfD of 0.14 mg/kg/day.

TABLE 6-5

**CONTAMINANTS OF POTENTIAL CONCERN
IN GROUNDWATER
SITE 43-AGAN STREET DUMP
REMEDIAL INVESTIGATION, CTO-0303
MCB, CAMP LEJEUNE, NORTH CAROLINA**

Contaminant	Minimum Value (µg/L)	Maximum Value (µg/L)	95% UCL of Lognormal Distribution (µg/L)	Location of Maximum Detected Value	Frequency of Detection	Frequency Percentage (%)	Region III Tap Water Screening Value (µg/L)	Screening Value Exceedance Frequency	Federal MCL (µg/L)	MCL Exceedance Frequency	NCWQS (µg/L)	NCWQS Exceedance Frequency
Semivolatiles:												
4-Methylphenol	2J	2J	5.92	43-TW04-01	1/10	10%	18	0/10	NA	NA	NA	NA
Inorganics:												
Aluminum	16.8J	25100	408,487.44	43-TW04-01	9/10	90%	3,700	2/10	NA	NA	NA	NA
Barium	10.3	104	268.84	43-TW04-01	8/10	80%	260	0/10	2,000	0/10	2,000	0/10
Calcium	3,410	81,800	254,429.63	43-TW04-01	10/10	100%	NA	NA	NA	NA	NA	NA
Cobalt	3.9	3.9	1.92	43-TW04-01	1/10	10%	220	0/10	NA	NA	NA	NA
Copper	60.9	60.9	18.83	43-GW01-01	1/10	10%	150	0/10	1,300	0/10	1,000	0/10
Iron	109J	33,800J	53,797.19	43-TW04-01	10/10	100%	1,100	3/10	NA	NA	300	8/10
Lead	1.4	1.9	1.35	43-TW01-01	3/10	30%	NA	NA	15	0/10	15	0/10
Magnesium	1,050	154,000	68,382.03	43-TW04-01	10/10	100%	NA	NA	NA	NA	NA	NA
Manganese	4.4	107	145.60	43-TW04-01	10/10	100%	510 ⁽¹⁾	0/10	NA	NA	50	2/10
Nickel	4.4	13	6.17	43-TW04-01	2/10	20%	73	0/10	100	0/10	100	0/10
Potassium	404	20,200	14,238.11	43-TW04-01	10/10	100%	NA	NA	NA	NA	NA	NA
Sodium	5180	1,130,000	1,038,460.68	43-TW04-01	10/10	100%	NA	NA	NA	NA	NA	NA
Vanadium	5.1	5.4	3.43	43-TW04-01	2/10	20%	26	0/10	NA	NA	NA	NA
Zinc	2.1	596	31,079.29	43-TW04-01	9/10	90%	1,100	0/10	NA	NA	2,100	0/10

Notes:

COPCs are indicated by the shaded areas.

⁽¹⁾ Screening value based on a RfD of 0.14 mg/kg/day.

TABLE 6-6

**CONTAMINANTS OF POTENTIAL CONCERN IN SURFACE WATER
SITE 43-AGAN STREET DUMP
REMEDIAL INVESTIGATION, CTO-0303
MCB, CAMP LEJEUNE, NORTH CAROLINA**

Contaminants	Minimum Value (µg/L)	Maximum Value (µg/L)	95% UCL of Lognormal Distribution (µg/L)	Location of Maximum Detected Value	Frequency of Detection	Frequency Percentage (%)	Base-Wide Average (µg/L)	Federal Water and Organisms (µg/L)	Federal Organisms only (µg/L)	State Freshwater (µg/L)	Region IV Water and Organisms (µg/L)	Region IV Organisms Only (µg/L)
Volatiles:												
1,2-Dichloroethene (total)	2J	2J	7.31	43-EC-SW02	2/6	33%	NA	--	--	--	--	--
Semivolatiles:												
bis(2-Ethylhexyl)phthalate	200	200	18,941.76	43-SHC-SW04	1/6	17%	NA	--	--	--	1.8	5.9
Pesticides:												
4,4'-DDE	0.095J	0.097J	0.10	43-EC-SW01	2/6	33%	ND	0.00059	0.00059	--	0.00059	0.00059
4,4'-DDD	0.12J	0.64J	2.30	43-EC-SW01	3/6	50%	ND	0.00083	0.00084	--	0.00084	0.00084
Inorganics:												
Aluminum	478	717	93,393.24	43-SHC-SW04	4/6	67%	333.17	--	--	--	--	--
Arsenic	1.8J	2.5	2.33	43-SHC-SW03	2/6	33%	ND	0.018	0.14	--	0.018	0.14
Barium	28.8	36.5	36.60	43-SHC-SW03	6/6	100%	25.67	--	--	--	--	--
Calcium	37,200	91,900	107,559.18	43-EC-SW02	6/6	100%	17,566.67	--	--	--	--	--
Copper	1.8	3.2	3.46	43-EC-SW02	3/6	50%	ND	--	--	--	1,300	--
Iron	670J	4,280J	6,196.97	43-SHC-SW01	6/6	100%	575.67	--	--	--	300	--
Lead	0.87J	2.8J	7.51	43-SHC-SW04	5/6	83%	ND	--	--	--	--	--
Magnesium	8,360	165,000	2,502,822.54	43-EC-SW02	6/6	100%	1,744.67	--	--	--	--	--
Manganese	38	57.1	55.94	43-SHC-SW03	6/6	100%	ND	--	--	--	--	--
Potassium	3,480J	55,200J	638,575.87	43-EC-SW02	6/6	100%	ND	--	--	--	--	--
Sodium	67,600	1,370,000	21,390,491.64	43-EC-SW02	6/6	100%	9,830	--	--	--	--	--
Vanadium	2.7	3.4	4.56	43-SHC-SW03	3/6	50%	ND	--	--	--	--	--

Notes:

COPCs indicated by the shaded areas.

TABLE 6-7

**CONTAMINANTS OF POTENTIAL CONCERN IN SEDIMENT
SITE 43-AGAN STREET DUMP
REMEDIAL INVESTIGATION, CTO-0303
MCB, CAMP LEJEUNE, NORTH CAROLINA**

Contaminant	Minimum Value	Maximum Value	95% UCL of Lognormal Distribution	Location of Maximum Value	Frequency of Detection	Frequency Percentage (%)	Base-Wide Average	Region IV Criteria ER-L	Region IV Criteria ER-M	ER-L (Long et. al., 1995)	ER-M (Long et. al., 1995)
Volatiles (µg/kg):											
Acetone	10J	140J	120.80	43-EC-SD01-06	3/12	25%	ND	--	--	--	--
Carbon Disulfide	3J	26	48.30	43-EC-SD02-612	3/12	25%	ND	--	--	--	--
Semivolatiles (µg/kg):											
4-Methylphenol	210J	210J	1,478.31	43-SHC-SD03-612	1/12	8%	ND	--	--	--	--
Pyrene	200	200J	1,513.96	43-EC-SD02-06	1/12	8%	ND	350	2,200	665	2,600
Bis(2-ethylhexyl)phthalate	280J	2500	1,419.76	43-SHC-SD03-06	10/12	83%	ND	--	--	--	--
Benzo(a)pyrene	290J	1900	1,470.36	43-SHC-SD02-612	4/12	33%	ND	400	2,500	430	1,600
Pesticides (µg/kg):											
4,4'-DDE	12J	8900	352,926.78	43-SHC-SD04-06	10/12	83%	2.42	2	15	2.2	27
Endrin	12J	16J	19.98	43-EC-SD01-06	2/11	18%	ND	0.02	45	--	--
4,4'-DDD	5.6J	37000	1.0E+08	43-SHC-SD04-06	11/12	92%	1.57	2	20	--	--
4,4'-DDT	9.3J	180J	130.71	43-EC-SD01-06	6/12	50%	2.20	1	7	1.58	46.1
alpha-Chlordane	7.2J	49J	48.41	43-SHC-SD03-612	8/12	67%	1.20	0.5	6	--	--
gamma-Chlordane	9.6J	74J	98.13	43-SHC-SD03-06	9/12	75%	1.44	0.5	6	--	--
Inorganics (mg/kg)											
Aluminum	878	16400	28,213.38	43-SHC-SD04-06	12/12	100%	1,165.57	--	--	--	--
Arsenic	2.1	5.7	15.53	43-EC-SD02-612	6/12	50%	0.37	33	85	8.2	70
Barium	4.4	46.1	52.61	43-SHC-SD03-06	12/12	100%	6.46	--	--	--	--
Beryllium	0.1	0.1	0.24	43-SHC-SD02-06	1/12	8%	0.09	--	--	--	--
Cadmium	4.8	4.8	3.94	43-EC-SD01-06	1/12	8%	0.04	5	9	1.2	9.6
Calcium	1,080	13,900	14,124.84	43-EC-SD02-612	12/12	100%	1,967.14	--	--	--	--
Chromium	1.8	27.2	25.48	43-EC-SD01-06	12/12	100%	1.86	80	145	81	370
Cobalt	0.66	3.1	4.49	43-EC-SD02-06	6/12	50%	ND	--	--	--	--

TABLE 6-7 (Continued)

CONTAMINANTS OF POTENTIAL CONCERN IN SEDIMENT
 SITE 43-AGAN STREET DUMP
 REMEDIAL INVESTIGATION, CTO-0303
 MCB, CAMP LEJEUNE, NORTH CAROLINA

Contaminant	Minimum Value	Maximum Value	95% UCL of Lognormal Distribution	Location of Maximum Value	Frequency of Detection	Frequency Percentage (%)	Base-Wide Average	Region IV Criteria ER-L	Region IV Criteria ER-M	ER-L (Long et. al., 1995)	ER-M (Long et. al., 1995)
Inorganics (mg/kg) (Continued)											
Copper	1.7	53	1,559.03	43-EC-SD01-06	9/12	75%	0.75	70	390	34	270
Iron	763	23,800	43,999.64	43-EC-SD02-612	12/12	100%	433.71	--	--	--	--
Lead	6.1	206	288.43	43-SHC-SD03-06	12/12	100%	0.79	35	110	46.7	218
Magnesium	82.5	6,440	44,957.70	43-EC-SD01-612	12/12	100%	45.25	--	--	--	--
Manganese	2.7	78.5	137.38	43-EC-SD01-06	12/12	100%	3.63	--	--	--	--
Mercury	0.44	0.66	0.57	43-EC-SD01-06	2/12	17%	0.14	0.15	1.3	0.15	0.71
Nickel	1.7	15.5	20.59	43-EC-SD01-06	6/12	50%	ND	30	50	20.9	51.6
Potassium	60.3	1,660	2,841.04	43-EC-SD02-612	12/12	100%	ND	--	--	--	--
Selenium	1.5J	2.6	5.00	43-SHC-SD03-06	5/12	42%	0.19	--	--	--	--
Silver	1.9	2.8	2.63	43-EC-SD02-06	2/12	17%	0.25	1	2.2	1.0	3.7
Sodium	52.7	14,800	802,290.49	43-EC-SD01-612	12/12	100%	ND	--	--	--	--
Vanadium	2.1	63.9	94.35	43-EC-SD01-06	12/12	100%	1.52	--	--	--	--
Zinc	1.5	338	1,139.82	43-EC-SD01-06	12/12	100%	5.11	120	270	150	410

Notes:

COPCs are indicated by the shaded areas.

TABLE 6-8

**SUMMARY OF EXPOSURE DOSE INPUT PARAMETERS
SITE 43-AGAN STREET DUMP
REMEDIATION INVESTIGATION, CTO-0303
MCB, CAMP LEJEUNE, NORTH CAROLINA**

Input Parameter	Units	Receptor					
		Trespasser Child	Trespasser Adult	Adult Military Personnel	Construction Worker	Residential Child	Residential Adult
Surface Soil (mg/kg)							
Ingestion Rate, IR	mg/d	100	50	100	NA	200	100
Fraction Ingested, FI	unitless	1	1	1	NA	1	1
Exposure Frequency, EF	d/y	130	43	250	NA	350	350
Exposure Duration, ED	y	6	30	4	NA	6	30
Surface Area, SA	cm ²	2,000	5,000	4,300	NA	2,300	5,800
Absorption Factor, AF	mg/cm ³	1	1	1	NA	1	1
Averaging Time, Noncarc., ATnc	d	2,190	10,950	1,460	NA	2,190	10,950
Averaging Time, Carc., ATcarc	d	25,550	25,550	25,550	NA	25,550	25,550
Body Weight, BW	kg	15	70	70	NA	15	70
Conversion Factor, CF	kg/mg	1x10 ⁻⁶	1x10 ⁻⁶	1x10 ⁻⁶	NA	1x10 ⁻⁶	1x10 ⁻⁶
Absorbance Factor, ABS	unitless	Organics = 0.01; Inorganics = 0.001					
Subsurface Soil (mg/kg)							
Ingestion Rate, IR	mg/d	NA	NA	NA	480	NA	NA
Fraction Ingested, FI	unitless	NA	NA	NA	1	NA	NA
Exposure Frequency, EF	d/y	NA	NA	NA	90	NA	NA
Exposure Duration, ED	y	NA	NA	NA	1	NA	NA
Surface Area, SA	cm ²	NA	NA	NA	4,300	NA	NA
Absorption Factor, AF	mg/cm ³	NA	NA	NA	1	NA	NA
Averaging Time, Noncarc., ATnc	d	NA	NA	NA	365	NA	NA
Averaging Time, Carc., ATcarc	d	NA	NA	NA	25,550	NA	NA
Body Weight, BW	kg	NA	NA	NA	70	NA	NA
Conversion Factor, CF	kg/mg	NA	NA	NA	1x10 ⁻⁶	NA	NA
Absorbance Factor, ABS	unitless	Organics = 0.01; Inorganics = 0.001					

TABLE 6-8 (Continued)

SUMMARY OF EXPOSURE DOSE INPUT PARAMETERS
 SITE 43-AGAN STREET DUMP
 REMEDIAL INVESTIGATION, CTO-0303
 MCB, CAMP LEJEUNE, NORTH CAROLINA

Input Parameter	Units	Receptor					
		Trespasser Child	Trespasser Adult	Adult Military Personnel	Construction Worker	Residential Child	Residential Adult
Groundwater (mg/L)							
Ingestion Rate, IR	L/d	NA	NA	NA	NA	1	2
Exposure Frequency, EF	d/y	NA	NA	NA	NA	350	350
Exposure Duration, ED	y	NA	NA	NA	NA	6	30
Exposure Time, ET	h/d	NA	NA	NA	NA	0.25	0.25
Surface Area, SA	cm ²	NA	NA	NA	NA	10,000	23,000
Averaging Time, Noncarc., ATnc	d	NA	NA	NA	NA	2,190	10,950
Averaging Time, Carc., ATcarc	d	NA	NA	NA	NA	25,550	25,550
Conversion Factor, CF	L/cm ³	NA	NA	NA	NA	0.001	0.001
Body Weight, BW	kg	NA	NA	NA	NA	15	70
Sediment (mg/kg)							
Ingestion Rate, IR	mg/d	200	100	NA	NA	200	100
Fraction Ingested, FI	unitless	1	1	NA	NA	1	1
Exposure Frequency, EF	d/y	45	45	NA	NA	45	45
Exposure Duration, ED	y	6	30	NA	NA	6	30
Surface Area, SA	cm ²	2,000	5,000	NA	NA	2,300	5,800
Absorption Factor, AF	mg/cm ³	1	1	NA	NA	1	1
Averaging Time, Noncarc., ATnc	d	2,190	10,950	NA	NA	2,190	10,950
Averaging Time, Carc., ATcarc	d	25,550	25,550	NA	NA	25,550	25,550
Body Weight, BW	kg	15	70	NA	NA	15	70
Conversion Factor, CF	kg/mg	1x10 ⁻⁶	1x10 ⁻⁶	NA	NA	1x10 ⁻⁶	1x10 ⁻⁶
Absorbance Factor, ABS	unitless	Organics = 0.01; Inorganics = 0.001					

TABLE 6-8 (Continued)

SUMMARY OF EXPOSURE DOSE INPUT PARAMETERS
 SITE 43-AGAN STREET DUMP
 REMEDIAL INVESTIGATION, CTO-0303
 MCB, CAMP LEJEUNE, NORTH CAROLINA

Input Parameter	Units	Receptor					
		Trespasser Child	Trespasser Adult	Adult Military Personnel	Construction Worker	Residential Child	Residential Adult
Surface Water (mg/L)							
Ingestion Rate, IR	L/d	0.005	0.005	NA	NA	0.005	0.005
Exposure Time, ET	h/d	2.6	2.6	NA	NA	2.6	2.6
Exposure Frequency, EF	d/y	45	45	NA	NA	45	45
Exposure Duration, ED	y	6	30	NA	NA	6	30
Surface Area, SA	cm ²	2,000	5,000	NA	NA	2,300	5,800
Body Weight, BW	kg	15	70	70	70	15	70
Averaging Time, Noncarc., ATnc	d	2,190	10,950	NA	NA	2,190	10,950
Averaging Time, Carc., ATcarc	d	25,550	25,550	NA	NA	25,550	25,550
Conversion Factor, CF	L/cm ³	0.001	0.001	NA	NA	0.001	0.001
Outdoor Air (mg/m³)							
Inhalation Rate, IR	m ³ /d	10	20	30	20	10	20
Exposure Frequency, EF	d/y	130	43	250	90	350	350
Exposure Duration, ED	y	6	30	4	1	6	30
Averaging Time, Noncarc., ATnc	d	2,190	10,950	1,460	365	2,190	10,950
Averaging Time, Carc., ATcarc	d	25,550	25,550	25,550	25,550	25,550	25,550
Body Weight, BW	kg	15	70	70	70	15	70
Particulate Emission Factor, PEF ⁽¹⁾	m ³ /kg	1.32E+09					

TABLE 6-8 (Continued)

SUMMARY OF EXPOSURE DOSE INPUT PARAMETERS
SITE 43-AGAN STREET DUMP
REMEDIAL INVESTIGATION, CTO-0303
MCB, CAMP LEJEUNE, NORTH CAROLINA

References:

USEPA Risk Assessment For Superfund Volume I, Human Health Manual (Part A) Interim Final, December, 1989.

USEPA Exposure Factors Handbook, July, 1989.

USEPA Risk Assessment For Superfund Volume I, Human Health Evaluation Manual Supplemental Guidance, "Standard Default Exposure Factors" Interim Final, March 25, 1991.

USEPA Dermal Exposure Assessment: Principles and Applications, Interim Report, January, 1992.

USEPA Region IV Guidance for Soil Absorbance. (USEPA, 1992)

⁽¹⁾To be published in the Final Soil Screening Level Guidance (USEPA, 1996)

Notes:

The exposure frequency for the trespasser receptors is based on the typical exposure pattern (i.e., more time spent outdoors in the warmer months vs. the cooler months) for people who actively garden or play outdoors. It is an upper-bound estimate (USEPA, 1992).

The skin surface area for the trespasser receptors is based on approximately 25 percent of the total surface body area for a child and adult receptor. These values are average estimates.

TABLE 6-9

**SUMMARY OF EXPOSURE PATHWAYS
SITE 43-AGAN STREET DUMP
REMEDIAL INVESTIGATION, CTO-0303
MCB, CAMP LEJEUNE, NORTH CAROLINA**

Receptor	Exposure Pathway
Current Adult Military Personnel	Surface soil ingestion, dermal contact and inhalation of fugitive dusts
Current Adult and Child Trespassers	Surface soil ingestion, dermal contact and inhalation of fugitive dusts Surface water ingestion and dermal contact Sediment ingestion and dermal contact
Future Adult and Child Residents	Surface soil ingestion, dermal contact, and inhalation of fugitive dusts Groundwater ingestion and dermal contact Surface water ingestion and dermal contact Sediment ingestion and dermal contact
Future Construction Worker	Subsurface soil ingestion, dermal contact, and inhalation of fugitive dusts

TABLE 6-10

**SUMMARY OF HEALTH-BASED CRITERIA
SITE 43-AGAN STREET DUMP
REMEDIAL INVESTIGATION, CTO-0303
MCB, CAMP LEJEUNE, NORTH CAROLINA**

COPCs	RfD (Oral) (mg/kg/d)	RfC (Inhal.) (mg/kg/d)	CSF (Oral) (mg/kg/d) ⁻¹	CSF (Inhal.) (mg/kg/d) ⁻¹	Weight-of-Evidence
VOLATILES					
Acetone	1.0E-01(i)	-	-	-	D
Carbon Disulfide	1.0E-01(i)	2.0E-01(i)	-	-	-
1,2-Dichloroethene (total)	9.0E-03(h)	-	-	-	D
SEMIVOLATILES					
4-Methylphenol	5.0E-03(h)	-	-	-	C
Benzo(a)anthracene	-	-	7.3E-01(e)	6.1E-01(e)	B2
Benzo(a)pyrene	-	-	7.3E+00(i)	6.1E+00(w)	B2
Benzo(b)fluoranthene	-	-	7.3E-01(e)	6.1E-01(e)	B2
Benzo(k)fluoranthene	-	-	7.3E-02(e)	6.1E-02(e)	B2
Dibenzo(a,h)anthracene	-	-	7.3E+00(e)	6.1E+00(e)	B2
Indeno(1,2,3-cd)pyrene	-	-	7.3E-01(e)	6.1E-01(e)	B2
Pyrene	3.0E-02(i)	-	-	-	D
PESTICIDES					
4,4'-DDD	-	-	2.4E-01(i)	-	B2
4,4'-DDE	-	-	3.4E-01(i)	-	B2
4,4'-DDT	5.0E-04(i)	-	3.4E-01(i)	3.4E-01(i)	B2
Endrin	3.0E-04(i)	-	-	-	D
alpha-Chlordane ⁽¹⁾	6.0E-05(i)	-	1.3E+00(i)	1.3E+00(i)	B2
gamma-Chlordane ⁽¹⁾	6.0E-05(i)	-	1.3E+00(i)	1.3E+00(i)	B2
METALS					
Aluminum	1.0(e)	-	-	-	-
Arsenic	3.0E-04(i)	-	1.5E+00(i)	1.5E+01(i)	A
Barium	7.0E-02(i)	1.4E-04(a)	-	-	D
Cadmium (water) (soil/sediment)	5.0E-04(i) 1.0E-03 ⁽²⁾	5.71E-05(e)	-	6.3E+00(i)	B1
Chromium VI	5.0E-03(i)	-	-	4.2E+01(i)	D
Cobalt	6.0E-02(e)	-	-	-	-
Copper	4.0E-02(e)	-	-	-	D
Iron	3.0E-01(e)	-	-	-	D
Lead	-	-	-	-	B2
Manganese (water)	1.4E-01(i)	1.4E-05(i)	-	-	D
Mercury	3.0E-04(h)	8.6E-05(h)	-	-	D
Nickel	2.0E-02(i)	-	-	-	D
Selenium	5.0E-03(i)	-	-	-	D

TABLE 6-10 (Continued)

SUMMARY OF HEALTH-BASED CRITERIA
 SITE 43-AGAN STREET DUMP
 REMEDIAL INVESTIGATION, CTO-231
 MCB, CAMP LEJEUNE, NORTH CAROLINA

COPCs	RfD (Oral) (mg/kg/d)	RfC (Inhal.) (mg/kg/d)	CSF (Oral) (mg/kg/d) ⁻¹	CSF (Inhal.) (mg/kg/d) ⁻¹	Weight-of- Evidence
Silver	5.0E-03(i)	-	-	-	D
Vanadium	7.0E-03(h)	-	-	-	D
Zinc	3.0E-01(i)	-	-	-	D

References:

- a = HEAST alternative
- e = EPA-NCEA Regional Support Provisional Value
- h = HEAST, 1994
- i = IRIS, 1995
- w = Withdrawn from IRIS or HEAST, but used in assessment, as recommended by Region IV Region III RBC Table, March, 1995

(1) Toxicity values for chlordane were substituted for this constituent.

(2) Toxicity value recommended by USEPA Region IV

- = Not applicable or available

TABLE 6-11

SUMMARY OF DERMALLY-ADJUSTED HEALTH-BASED CRITERIA*
SITE 43-AGAN STREET DUMP
REMEDIAL INVESTIGATION, CTO-0303
MCB, CAMP LEJEUNE, NORTH CAROLINA

COPCs	Percent Absorbed ⁽¹⁾	Oral RfD mg/kg/d	Oral RfD (Dermally-Adjusted) mg/kg/d	Oral CSF (mg/kg/d) ⁻¹	Oral CSF (Dermally-Adjusted) (mg/kg/d) ⁻¹
VOLATILES					
Acetone	80%	1.00E-01	8.00E-02	--	--
Carbon Disulfide	80%	1.00E-01	8.00E-02	--	--
1,2-Dichloroethene (total)	80%	9.00E-03	7.20E-03	--	--
SEMIVOLATILES					
4-Methylphenol	50%	5.00E-03	2.50E-03	--	--
Benzo(a)anthracene	50%	--	-	7.30E-01	1.46E+00
Benzo(a)pyrene	50%	--	-	7.30E+00	1.46E+01
Benzo(b)fluoranthene	50%	--	-	7.30E-01	1.46E+00
Benzo(k)fluoranthene	50%	--	-	7.30E-02	1.46E-01
Dibenzo(a,h)anthracene	50%	--	-	7.30E+00	1.46E+01
Indeno(1,2,3-cd)pyrene	50%	--	-	7.30E-01	1.46E+00
Pyrene	50%	3.00E-02	1.50E-02	--	-
PESTICIDES					
4,4'-DDD	50%	--	-	2.40E-01	4.80E-01
4,4'-DDE	50%	--	-	3.40E-01	6.80E-01
4,4'-DDT	50%	5.00E-04	2.50E-04	3.40E-01	6.80E-01
alpha-Chlordane	50%	6.00E-05	3.00E-05	1.30E+00	2.60E+00
gamma-Chlordane	50%	6.00E-05	3.00E-05	1.30E+00	2.60E+00
METALS					
Aluminum	20%	1.00E+00	2.00E-01	--	-
Arsenic	20%	3.00E-04	6.00E-05	1.50E+00	7.50E+00
Barium	20%	7.00E-02	1.40E-02	--	--
Cadmium (water)	20%	5.00E-04	1.00E-04	--	--
Cadmium (soil/sediment)	20%	1.00E-03	2.00E-04	--	--
Chromium	20%	5.00E-03	1.00E-03	--	--
Cobalt	20%	6.00E-02	1.20E-02	--	--
Copper	20%	3.70E-02	7.40E-03	--	--
Iron	20%	3.00E-01	6.00E-02	--	--
Lead	20%	--	--	--	--
Manganese	20%	1.40E-01	2.80E-02	--	--
Mercury	20%	3.00E-04	6.00E-05	--	--
Nickel	20%	2.00E-02	4.00E-03	--	--
Selenium	20%	5.00E-03	1.00E-03	--	--

TABLE 6-11 (Continued)

SUMMARY OF DERMALLY-ADJUSTED HEALTH-BASED CRITERIA*
 SITE 43-AGAN STREET DUMP
 REMEDIAL INVESTIGATION, CTO-0303
 MCB, CAMP LEJEUNE, NORTH CAROLINA

COPCs	Percent Absorbed ⁽¹⁾	Oral RfD mg/kg/d	Oral RfD (Dermally-Adjusted) mg/kg/d	Oral CSF (mg/kg/d) ⁻¹	Oral CSF (Dermally-Adjusted) (mg/kg/d) ⁻¹
Silver	20%	5.00E-03	1.00E-03	--	--
Vanadium	20%	7.00E-03	1.40E-03	--	--
Zinc	20%	3.00E-01	6.00E-02	--	--

Notes:

- ⁽¹⁾ Region IV recommended values (i.e., 80% for VOCs, 50% for SVOCs/Pesticides, and 20% for Inorganics)
 - = Not Applicable
 * = Only oral toxicity values were dermally adjusted; inhalation toxicity values were not adjusted.

Dermally-adjusted RfD = oral RfD*percent absorbed
 Dermally-adjusted CSF = oral CSF/percent absorbed

References:

IRIS, 1995
 HEAST, 1994
 Region III RBC Table, March, 1995

TABLE 6-12

**SUMMARY OF RISKS FOR THE
MILITARY RECEPTOR
SITE 43-AGAN STREET DUMP
REMEDIAL INVESTIGATION, CTO-0303
MCB, CAMP LEJEUNE, NORTH CAROLINA**

Exposure Pathway	Noncarcinogenic Risk	Carcinogenic Risk
Surface Soil		
Ingestion	2.4E-02	9.6E-07
Dermal Contact	5.1E-03	8.2E-07
Inhalation	7.1E-05	1.3E-08
Total Risk	2.9E-02	1.8E-06

TABLE 6-13
SUMMARY OF RISKS FOR THE
CHILD TRESPASSER
SITE 43-AGAN STREET DUMP
REMEDIAL INVESTIGATION, CTO-0303
MCB, CAMP LEJEUNE, NORTH CAROLINA

Exposure Pathway	Noncarcinogenic Risk	Carcinogenic Risk
Surface Soil		
Ingestion	5.8E-02	3.5E-06
Dermal Contact	5.8E-03	1.4E-06
Inhalation	2.3E-04	6.3E-08
total	6.4E-02	4.9E-06
Surface Water		
Ingestion	2.6E-03	3.4E-08
Dermal Contact	6.4E-03	3.8E-06
total	9.0E-03	3.8E-06
Sediment		
Ingestion	2.3E-01	4.5E-06
Dermal Contact	1.2E-02	7.1E-07
total	2.5E-01	5.2E-06
Current Risk	3.2E-01	1.4E-05

TABLE 6-14

**SUMMARY OF RISKS FOR THE
FUTURE CHILD RESIDENT
SITE 43-AGAN STREET DUMP
REMEDIAL INVESTIGATION, CTO-0303
MCB, CAMP LEJEUNE, NORTH CAROLINA**

Exposure Pathway	Noncarcinogenic Risk	Carcinogenic Risk
Surface Soil		
Ingestion	3.1E-01	1.9E-05
Dermal Contact	1.8E-02	4.3E-06
Inhalation	8.6E-05	2.3E-08
total	3.3E-01	2.3E-05
Groundwater		
Ingestion	8.8E+00	--
Dermal Contact	1.1E-01	--
Inhalation	--	--
total	8.9E+00	--
Surface Water		
Ingestion	3.0E-03	3.4E-08
Dermal Contact	6.0E-03	5.0E-07
total	9.0E-03	5.4E-07
Sediment		
Ingestion	2.4E-01	4.5E-06
Dermal Contact	1.4E-02	8.1E-07
total	2.5E-01	5.3E-06
Current Risk	5.9E-01	2.9E-05
Future Risk	9.5E+00	5.8E-06

Notes:

-- = Not Applicable

Bolded values indicate risk values that exceed the acceptable risk value of 1.0 for noncarcinogenic effects.

TABLE 6-15

**SUMMARY OF RISKS FOR THE
ADULT TRESPASSER
SITE 43-AGAN STREET DUMP
REMEDIAL INVESTIGATION, CTO-0303
MCB, CAMP LEJEUNE, NORTH CAROLINA**

Exposure Pathway	Noncarcinogenic Risk	Carcinogenic Risk
Surface Soil		
Ingestion	2.1E-03	6.2E-07
Dermal Contact	1.0E-03	1.2E-06
Inhalation	8.1E-06	1.1E-08
total	3.1E-03	1.9E-06
Surface Water		
Ingestion	5.6E-04	3.6E-08
Dermal Contact	3.4E-03	1.0E-05
total	4.0E-03	1.0E-05
Sediment		
Ingestion	2.5E-02	2.4E-06
Dermal Contact	6.6E-03	1.9E-06
total	3.2E-02	4.3E-06
Current Risk	3.9E-02	1.6E-05

TABLE 6-16

**SUMMARY OF RISKS FOR THE
FUTURE ADULT RESIDENT
SITE 43-AGAN STREET DUMP
REMEDIAL INVESTIGATION, CTO-0303
MCB, CAMP LEJEUNE, NORTH CAROLINA**

Exposure Pathway	Noncarcinogenic Risk	Carcinogenic Risk
Surface Soil		
Ingestion	3.3E-02	1.0E-05
Dermal Contact	9.7E-03	1.2E-05
Inhalation	6.6E-05	9.0E-08
total	4.3E-02	2.2E-05
Groundwater		
Ingestion	3.8E+00	--
Dermal Contact	5.4E-02	--
Inhalation	--	--
total	3.8E+00	--
Surface Water		
Ingestion	5.6E-04	3.6E-08
Dermal Contact	3.3E-03	1.4E-06
total	3.9E-03	1.4E-06
Sediment		
Ingestion	2.5E-02	2.4E-06
Dermal Contact	7.7E-03	2.2E-06
total	3.3E-02	4.6E-06
Current Risk	8.0E-02	2.8E-05
Future Risk	3.9E+00	6.0E-06

Notes:

-- = Not Applicable

Bolded values indicate risk values that exceed the acceptable risk value of 1.0 for noncarcinogenic effects.

TABLE 6-17

**SUMMARY OF RISKS FOR THE
FUTURE CONSTRUCTION WORKER
SITE 43-AGAN STREET DUMP
REMEDIAL INVESTIGATION, CTO-0303
MCB, CAMP LEJEUNE, NORTH CAROLINA**

Exposure Pathway	Noncarcinogenic Risk	Carcinogenic Risk
Subsurface Soil		
Ingestion	1.3E-02	7.6E-08
Dermal Contact	5.8E-04	1.4E-08
Inhalation	--	2.0E-12
Total Risk	1.4E-02	9.0E-08

Notes:

-- = Not applicable

TABLE 6-18

SUMMARY OF UNCERTAINTIES IN THE RESULTS OF THE
HUMAN HEALTH RISK ASSESSMENT
SITE 43-AGAN STREET DUMP
REMEDIAL INVESTIGATION, CTO-0303
MCB, CAMP LEJEUNE, NORTH CAROLINA

	Potential Magnitude for Over-Estimation of Risks	Potential Magnitude for Under-Estimation of Risks	Potential Magnitude for Over or Under-Estimation of Risks
<u>Environmental Sampling and Analysis</u>			
Sufficient samples may not have been taken to characterize the media being evaluated.			Low
Systematic or random errors in the chemical analysis may yield erroneous data.			Low
<u>Selection of COPCs</u>			
The use of USEPA Region III COPC screening concentrations in selecting COPCs in soil and groundwater.			Low
<u>Exposure Assessment</u>			
The standard assumptions regarding body weight, exposure period, life expectancy, population characteristics, and lifestyle may not be representative of the actual exposure situations.			Moderate
The use of the 95th percentile upper confidence level data of the lognormal distribution in the estimation of the RME.			Low
Assessing future residential property use when the likelihood of residential development is low.	High		
The amount of media intake is assumed to be constant and representative of any actual exposure.			Low
<u>Toxicological Assessment</u>			
Toxicological indices derived from high dose animal studies, extrapolated to low dose human exposure.	Moderate		
Lack of promulgated toxicological indices for inhalation pathway.		Low	
<u>Risk Characterization</u>			
Assumption of additivity in the quantitation of cancer risks without consideration of synergism, antagonism, promotion and initiation.			Moderate

TABLE 6-18 (Continued)

**SUMMARY OF UNCERTAINTIES IN THE RESULTS OF THE
HUMAN HEALTH RISK ASSESSMENT
SITE 43-AGAN STREET DUMP
REMEDIAL INVESTIGATION, CTO-0303
MCB, CAMP LEJEUNE, NORTH CAROLINA**

	Potential Magnitude for Over-Estimation of Risks	Potential Magnitude for Under-Estimation of Risks	Potential Magnitude for Over or Under-Estimation of Risks
Assumption of additivity in the estimation of systemic health effects without consideration of synergism, antagonism, etc.			Moderate
Additivity of risks by individual exposure pathways (dermal and ingestion and inhalation).	Low		Low
Compounds not quantitatively evaluated.		Low	

Notes:

- Low = Assumptions categorized as "low" may effect risk estimates by less than one order of magnitude.
- Moderate = Assumptions categorized as "moderate" may effect estimates of risk by between one and two orders of magnitude.
- High = Assumptions categorized as "high" may effect estimates of risk by more than two orders of magnitude.

Source: Risk Assessment Guidance for Superfund, Volume 1, Part A: Human Health Evaluation Manual. USEPA, 1989a.

TABLE 6-19

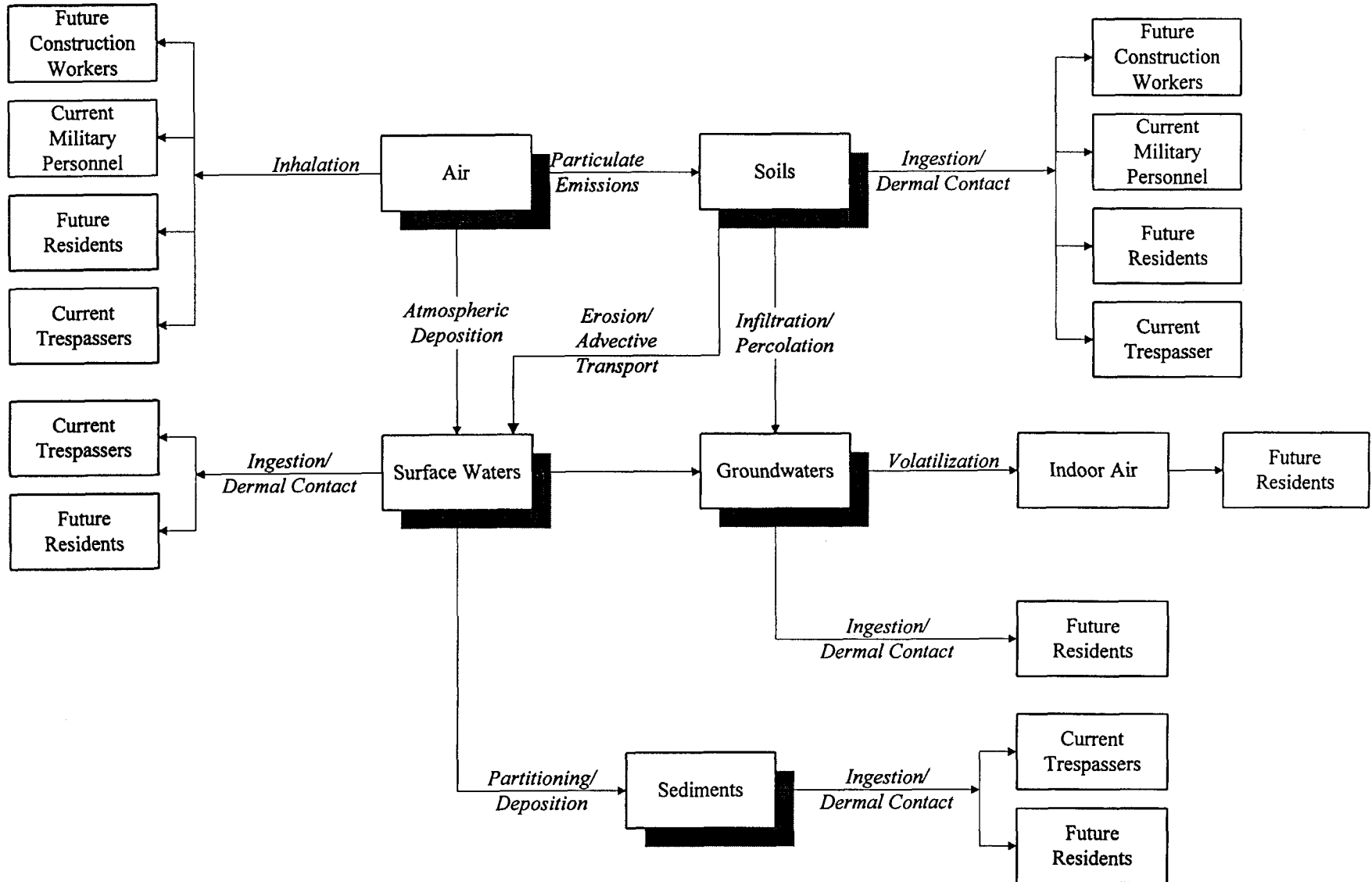
SUMMARY OF CONTAMINANTS CONTRIBUTING TO SITE RISKS
SITE 43-AGAN STREET DUMP
REMEDIAL INVESTIGATION, CTO-0303
MCB, CAMP LEJEUNE, NORTH CAROLINA

Site and Exposure Medium	Contaminant	Concentration
Site 43 Groundwater	Aluminum Iron	25.1 mg/L (<i>max</i>) 33.8 mg/L (<i>95% UCL</i>)

SECTION 6.0 FIGURES

FIGURE 6-1

FLOWCHART OF POTENTIAL EXPOSURE PATHWAYS AND RECEPTORS
SITE 43: AGAN STREET DUMP



7.0 ECOLOGICAL RISK ASSESSMENT

The Comprehensive Environmental Response, Compensation, and Liability Act of 1980 (CERCLA) as amended by the Superfund Amendments and Reauthorization Act (SARA) of 1986, directs USEPA to protect human health and the environment with respect to releases or potential releases of contaminants from abandoned hazardous waste sites (USEPA, 1989a). This section of the report presents the ecological risk assessment (ERA) conducted at Operable Unit No. 6, Site 43 that assesses the potential impacts to ecological receptors from contaminants detected at this site.

7.1 Objectives, Scope, and Organization of the Ecological Risk Assessment

The objective of this ERA is to evaluate if past reported disposal practices at Site 43 are potentially adversely impacting the terrestrial and aquatic communities on, or adjacent to, the site. This assessment also evaluates the potential effects of contaminants related to Site 43 on sensitive environments including wetlands, protected species, and fish nursery areas. The conclusions of the ERA are used in conjunction with the human health risk assessment to evaluate the appropriate remedial action for this site for the overall protection of public health and the environment. If potential risks are characterized for the ecological receptors, further ecological evaluation of the site and surrounding areas may be warranted.

This ERA evaluates and analyzes the results from the Remedial Investigation (RI) including chemical analysis of the soil, groundwater, surface water, and sediment. In addition, surface water and sediment bioassays were conducted at one station. The media of concern for this ERA are the surface soil, surface water, and sediment. Information used to evaluate sensitive environments is obtained from historical data and previous studies obtained in the literature, or through conversations with appropriate state, federal, and local personnel.

The risk assessment methodologies used in this evaluation are consistent with those outlined in the Ecological Risk Assessment Guidance for Superfund: Process for Designing and Conducting Ecological Risk Assessments (USEPA, 1994a) and Framework for Ecological Risk Assessment (USEPA, 1992). In addition, information found in the following documents was used to supplement the USEPA guidance document:

- USEPA Supplemental Risk Assessment Guidance for Superfund, Volume II, Environmental Evaluation Manual (USEPA, 1989a)
- Ecological Assessment of Hazardous Waste Sites: A Field and Laboratory Reference (USEPA, 1989b)

Based on the USEPA Framework for Ecological Risk Assessment, an ERA consists of three main components: 1) Problem Formulation; 2) Analysis; and, 3) Risk Characterization (USEPA, 1992). The problem formulation section includes a preliminary characterization of exposure and effects of the stressors to the ecological receptors. During the analysis, the data is evaluated to determine the exposure and potential effects on the ecological receptors from the stressors. Finally, in the risk characterization, the likelihood of adverse effects occurring as a result of exposure to a stressor is evaluated. This section also evaluates the potential impact on the ecological integrity at the site from the contaminants detected in the media. This ERA is organized to parallel these three components.

7.2 Problem Formulation

Problem formulation is the first step of an ERA and includes a preliminary characterization of exposure and effects (USEPA, 1992a). Chemical analyses were performed on samples collected from the soil, groundwater, surface water, and sediment to evaluate the presence, concentrations, and variabilities of the contaminants. A habitat characterization also was conducted as part of the field activities. Based on these observations, potential ecological receptors were identified. Finally, toxicological information for the contaminants detected in the media was obtained from available references and literature and used to evaluate the potential adverse ecological effects to the ecological receptors.

The components of the problem formulation include identifying the stressors and their potential ecological effects, identification of ecosystems potentially at risk, defining ecological endpoints and presenting a conceptual model. The following sections discuss each of these components, and how they are evaluated in this ERA.

7.3 Contaminants of Potential Concern

One of the initial steps in the problem formulation stage of an ERA is identifying the stressors and their potential ecological effects. For this ERA, the stressors that are evaluated include contaminants detected in the surface soil, surface water, and sediment.

Contaminants in the subsurface soil and groundwater are not evaluated in this ERA. Some terrestrial species burrow in the subsurface soil, and microorganisms most likely exist in the groundwater. However, current guidance does not provide sufficient information to evaluate risk to these receptors.

The nature and extent of contaminants detected in the environmental media at Site 43 are presented in Section 4.0 of this report. Sample locations are based on available historical site information and a site visit to evaluate potential ecosystems and ecological receptors.

7.3.1 Criteria for Selecting Contaminants of Potential Concern

Quantifying risk for all positively identified contaminants may distract from the dominant risk-driving contaminants at the site. Therefore, the data set was reduced to a list of contaminants of potential concern (COPCs). COPCs are site-related contaminants used to quantitatively estimate ecological exposures and associated potential ecological effects.

The criteria used in selecting the COPCs from the contaminants detected during the field sampling and analytical phase of the investigation are:

- Historical information
- Prevalence
- Toxicity
- Comparison to federal and state criteria and standards
- Comparison to investigation associated field and laboratory blank data
- Comparison to background or naturally occurring levels
- Comparison to anthropogenic levels

7.3.1.1 Historical Information

Using historical information to associate contaminants with site activities, when combined with the following selection procedures, helps determine contaminant retention or elimination. To be conservative, contaminants detected in the media that may not have been historically used at a site are retained as COPCs to evaluate risk, but may be eliminated in the ecological significance section as not being site-related.

7.3.1.2 Prevalence

The frequency of positive detections in sample sets and the level at which a contaminant is detected in a given medium are factors that determine a chemical's prevalence. Contaminants that were detected infrequently are not retained as COPCs.

7.3.1.3 Toxicity

The potential toxicity of a contaminant is an important consideration when selecting COPCs for further evaluation in the ERA. Several of the contaminants detected in the media at Site 43 are prevalent, however, their inherent toxicity to aquatic and terrestrial receptors is low (e.g., calcium, magnesium, potassium, and sodium). Therefore, they are not retained as COPCs. In addition, several contaminants have not been adequately studied to develop published toxicity values, or even accepted toxicological data with which to assess the contaminants. Contaminants that fall into this category are retained as COPCs (if they are not eliminated due to other criteria), however, they are not quantitatively evaluated in the ERA.

7.3.1.4 State and Federal Criteria and Standards

Water Quality Standards (WQS) for surface water have been developed for North Carolina (NC DEHNR, 1994). These are the only enforceable surface water standards. In addition to the WQS, Water Quality Screening Values (WQSVs) have been developed by USEPA Region IV (USEPA, 1995a), USEPA Region III (USEPA, 1995b), and Oak Ridge National Laboratory (ORNL) (Suter and Mabrey, 1994). The WQS and WQSVs will be herein referred to as Surface Water Screening Values (SWSVs).

Sediment quality standards have not been developed for North Carolina. However, Sediment Screening Values (SSVs) are available for many contaminants. These SSVs include the following: Sediment Screening Levels (SSLs) (Long et. al, 1995; Long and Morgan, 1991; and, USEPA, 1995b), calculated sediment quality criteria (SQC) (USEPA, 1993a), Apparent Effect Threshold values (AET) (Tetra-Tech, Inc., 1986), and Wisconsin Department of Natural Resources interim guidance criteria for in-water disposal of dredged sediments (Sullivan, et. al., 1985).

The SWSVs and SSVs are used for comparative purposes to infer potential ecological risks. Contaminants that were detected at concentrations less than these screening values are not retained as COPCs for aquatic receptors since contaminants detected at concentrations less than these values are not expected to pose a significant risk to the aquatic receptor population. However, these contaminants may be retained as COPCs for the terrestrial receptors.

There are no state or federal soil screening values that can be used to evaluate potential ecological risks to terrestrial receptors (other than plants or invertebrates). Therefore, toxicity of contaminants

in the surface soil to terrestrial receptors is not used as criteria for retaining COPCs except for calcium, magnesium, potassium, and sodium, which are not retained as COPCs in any of the media.

A brief explanation of the standards, criteria, and screening values used for the evaluation of the COPCs is presented below.

North Carolina Water Quality Standards (Surface Water) - WQS are the concentrations of toxic substances that will not result in chronic toxicity to aquatic life (NCDEHNR, 1994). WQS are provided for both freshwater and saltwater aquatic systems.

USEPA Water Quality Screening Values - WQSVs are non-enforceable regulatory guidelines and are of primary utility in assessing acute and chronic toxic effects in aquatic systems. WQSVs are provided for both freshwater and saltwater aquatic systems, and are reported as acute and/or chronic values (USEPA, 1995a,b). Most of the WQSVs are the same as the USEPA Ambient Water Quality Criteria (AWQC), however, some of the WQSVs are based on more current studies.

Oak Ridge National Laboratory Aquatic Benchmarks - ORNL Aquatic Benchmarks are developed for many contaminants, including those that do not have WQS or WQSVs (Suter and Mabrey, 1994). The ORNL aquatic benchmarks include secondary acute values and secondary chronic values that are calculated using the Tier II method described in the EPA's Proposed Water Quality Guidance for the Great Lakes System (USEPA, 1993b). Tier II values are developed so that aquatic benchmarks could be established with fewer data than are required for the USEPA AWQC. The benchmarks are limited to contaminants in freshwater.

Sediment Screening Levels - Sediment Screening Levels (SSLs) have been compiled to evaluate the potential for contaminants in sediments to cause adverse biological effects (Long, et. al, 1995; Long and Morgan 1991; and, USEPA, 1995b). The lower ten percentile (Effects Range-Low [ER-L]) and the median percentile (Effects Range-Median [ER-M]) of biological effects have been developed for several contaminants. The concentration below the ER-L represents a minimal-effects range (adverse effects would be rarely observed). The concentration above the ER-L but below the ER-M represents a possible-effects range (adverse effects would occasionally occur). Finally, the concentration above the ER-M represents a probable-effects range (adverse effects would probably occur).

In addition to the SSLs, Apparent Effects Threshold (AET) Sediment Quality Values have been developed by Tetra Tech Inc., (1986) for the Puget Sound. AETs are the concentrations of contaminants above which statistically significant biological effects would always be expected. Finally, the Wisconsin Department of Natural Resources has developed interim criteria for in-water disposal of dredged sediments (Sullivan, et. al., 1985). However, these criteria are established using background data and are not based on aquatic toxicity.

Sediment Quality Criteria - Currently, promulgated sediment quality criteria (SQC) only exist for a few contaminants. However, SQC for nonionic organic compounds can be calculated using the procedures in the Technical Basis for Deriving Sediment Quality Criteria for Nonionic Organic Contaminants for the Protection of Benthic Organisms by using Equilibrium Partitioning (USEPA, 1993a) as follows:

$$SQC = (Foc)(Koc)(FCV)/1,000,000$$

Where:

SQC = sediment quality criteria ($\mu\text{g}/\text{kg}$)

Foc = sediment organic carbon content (mg/kg)

Koc = chemical organic carbon partition coefficient (mL/g)

FCV = final chronic water quality value ($\mu\text{g}/\text{L}$)

7.3.1.5 Field and Laboratory Blank Data

Associating contaminants detected in field related blanks (i.e., trip blanks, equipment rinsates and/or field blanks) or laboratory method blanks with the same contaminants detected in analytical samples can eliminate non-site-related contaminants from the list of COPCs. Blank data should be compared to sample results with which the blanks are associated. However, for this data set it is difficult to associate specific blanks with specific environmental samples. Thus, in order to evaluate detection levels, maximum contaminant concentrations reported in a given set of blanks are applied to a corresponding set of samples.

In accordance with the National Functional Guidelines for Organics, common lab contaminants (i.e., acetone, 2-butanone, methylene chloride, toluene, and phthalate esters) should be regarded as a direct result of site activities only when sample concentrations exceed 10 times the maximum blank concentration. For other contaminants not considered common in a lab, concentrations exceeding 5 times the maximum blank concentration indicates contamination resulting from site activities (USEPA, 1991a).

Contract Required Quantitation Limits (CRQLs) and percent moisture are employed when evaluating contaminant concentrations in soil, in order to correlate solid and aqueous detection limits. For example, the CRQL for semivolatiles in soil is 33 to 66 times that of aqueous samples, depending on the contaminant. In order to assess semivolatile contaminant levels in soil using aqueous blanks, the blank concentration must then also be multiplied by 33 or 66 to account for variance from the CRQL (common lab contaminants must first be multiplied by 5 or 10, as explained in the paragraph above). The final value is divided by the sample percent moisture.

Eliminating a sample result correlates directly to a reduction in the contaminant prevalence in that medium. Consequently, if elimination due to blank concentration reduces the prevalence of a contaminant to less than 5 percent, a contaminant that may have been included according to its prevalence is eliminated as a COPC.

Maximum concentrations of common laboratory contaminants detected in blanks are presented in Section 6.0, Table 6-1. Blanks containing organic constituents that are not considered common laboratory contaminants (i.e., all other TCL compounds) are regarded as positive results only when observed concentrations exceed 5 times the maximum concentration detected in any blank (USEPA, 1989a). All TCL compounds at less than 5 times the maximum level of contamination noted in any blank are considered not detected in that sample.

7.3.1.6 Background or Naturally Occurring Levels

Contaminants that were detected in the surface soil at concentrations less than two-times the average Base background concentration are not retained as COPCs. Off-site surface water and sediment samples were collected from several waterbodies in the White Oak River water basin (see Appendix T). The contaminant concentrations in the site samples and the off-site background samples are

compared to each other to determine if contaminant concentrations in the site stations are below naturally occurring regional levels.

The two water bodies sampled at Site 43 are Edwards Creek and Strawhorn Creek. The majority of the samples are tidally influenced. Therefore, the mid-stream saltwater off-site background surface water and sediment samples are compared to the Site 43 samples to determine if contaminant concentrations are within background concentrations. Contaminants that were detected in the surface water or sediment at concentrations less than the average background concentration are not retained as COPCs.

7.3.1.7 Anthropogenic Levels

Ubiquitous anthropogenic background concentrations result from non-site related sources such as combustion of fossil fuels (i.e., automobiles), plant synthesis, natural fires and factories. Examples of ubiquitous, anthropogenic chemicals are polycyclic aromatic hydrocarbons (PAHs). Anthropogenic chemicals are typically not eliminated as COPCs without considering other selection criteria. It is difficult to determine that such chemicals are present at the site due to operations not related to the site or the surrounding area. Omitting anthropogenic background chemicals from the risk assessment may result in the loss of important information for those potentially exposed.

The following sections apply the aforementioned selection criteria beginning with the prevalence of detected analytical results in each medium of interest to establish a preliminary list of COPCs for Site 43. Once this task has been completed, a final list of media-specific COPCs will be selected based on the remaining criteria.

7.3.2 **Selection of Contaminants of Potential Concern**

The following sections present an overview of the analytical data obtained for each medium during the RI and the subsequent retention or elimination of COPCs using the aforementioned selection criteria. Contaminants that are not eliminated due to the above criteria are retained as COPCs. The primary reasons for retaining contaminants as COPCs include, but may not be limited to the following: (1) frequently detected, (2) detected at concentrations above the screening values (if available) and/or (3) detected at concentrations above background (if available). In addition, some common laboratory contaminants (i.e., phthalates, acetone) are retained as COPCs because they were detected frequently and were not detected in the blank samples. Finally, calcium, magnesium, potassium, and sodium are not retained as COPCs in any of the media because they are common naturally occurring chemicals, are not related to the site, and no published toxicity data was identified to assess potential impacts to aquatic or terrestrial life.

Tables 7-1 and 7-2 present the comparison of the total and dissolved surface water contaminant concentrations to the SWSVs and the off-site background sample contaminant concentrations, respectively. Table 7-3 presents the comparison of the sediment contaminant concentrations to applicable SSVs and the off-site background sample contaminant concentrations. A comparison of the surface soil contaminant concentrations to base-background concentrations is presented in Section 6.0, Table 6-3. A summary of the COPCs retained in each media is presented in Table 7-4.

7.3.2.1 Surface Soil

Twenty-eight surface soil samples were collected at Site 43. All twenty-eight samples were analyzed for TCL VOCs and SVOCs, twenty-one samples were analyzed for TAL metals, and seven samples were analyzed for TCL pesticides/PCBs.

No VOCs were detected in the surface soil. Twenty-one SVOCs were detected in the surface soil. Acenaphthylene, 2-methylnaphthalene, and 4-methylphenol are not retained as COPCs because they were detected infrequently (1/28). The remaining eighteen SVOCs [acenaphthene, anthracene, benzo(a)anthracene, benzo(a)pyrene, benzo(b)fluoranthene, benzo(g,h,i)perylene, benzo(k)-fluoranthene, bis(2-ethylhexyl)phthalate, butylbenzylphthalate, carbazole, chrysene, dibenzo(a,h)-anthracene, dibenzofuran, fluoranthene, fluorene, indeno(1,2,3-cd)pyrene, phenanthrene, and pyrene] are retained as COPCs.

Five pesticides were detected in the surface soil. The pesticides 4,4'-DDD, 4,4'-DDE, 4,4'-DDT, endrin aldehyde, and heptachlor epoxide, are retained as COPCs.

Nineteen metals were detected in the surface soil. Arsenic and selenium are not retained as COPCs because they were detected at concentrations of less than two times the base-background concentration. As presented above, calcium, magnesium, potassium, and sodium are not retained as COPCs. The remaining thirteen metals (aluminum, barium, cadmium, chromium, cobalt, copper, iron, lead, manganese, mercury, nickel, vanadium, and zinc) are retained as COPCs.

7.3.2.2 Surface Water

Six surface water samples were collected at Site 43 in Edwards Creek and Strawhorn Creek. All the samples were analyzed for TCL VOCs, SVOCs, pesticides/PCBs, and TAL metals (total and dissolved).

Most of the surface water and sediment sample stations at Site 43 are tidally influenced and are classified as saltwaters by the state of North Carolina. Therefore, the contaminant concentrations in the surface water and sediment samples are compared to the saltwater screening values.

One VOC (total 1,2-dichloroethene) and one SVOC [bis(2-ethylhexyl)phthalate] were detected in the surface water. The VOC 1,2-dichloroethene is not retained as a COPC for the aquatic receptors because it was detected at a concentration below the SWSV. Bis(2-ethylhexyl)phthalate is not retained as a COPC for the aquatic or terrestrial receptors because it was detected at a concentration less than ten times the concentration in the blank sample. Two pesticides (4,4'-DDD and 4,4'-DDE) were detected and retained as COPCs in the surface water for both the aquatic and terrestrial receptors.

Twelve metals (total) were detected in the surface water. Arsenic, lead, and vanadium are not retained as COPCs for the aquatic receptors because they were detected at concentrations below the SWSVs. As presented above, calcium, magnesium, potassium, and sodium are not retained as COPCs for either the aquatic or terrestrial receptors. The remaining five metals (aluminum, barium, copper, iron, and manganese) are retained as COPCs for both the aquatic and terrestrial receptors.

Nine metals (dissolved) were detected in the surface water. Vanadium and copper are not retained as COPCs because they were detected at concentrations below the SWSVs. As presented above,

calcium, magnesium, potassium, and sodium are not retained as COPCs. The remaining three metals (barium, iron, and manganese) are retained as COPCs.

7.3.2.3 Sediment

Twelve sediment samples were collected at Site 43 in Edwards Creek and Strawhorn Creek. At each sediment station, samples were collected from two depths, 0 to 6 inches and 6 to 12 inches. All the samples were analyzed for TCL VOCs, SVOCs, pesticides/PCBs, and TAL metals, while selected samples were analyzed for total organic carbon (TOC). The lowest TOC value was used to calculate the SQC screening values, since this is the most conservative approach for the initial screening. Appendix U contains the SQC calculations.

Two VOCs (acetone and carbon disulfide) were detected in the sediment. Both VOCs are retained as COPCs. Four SVOCs were detected in the sediment. The SVOCs 4-methylphenol and pyrene are not retained as COPCs because they did not exceed the SSVs. Benzo(a)pyrene and bis(2-ethylhexyl)phthalate are the only SVOCs retained as COPCs. Six pesticides (4,4'-DDD, 4,4'-DDE, 4,4'-DDT, alpha-chlordane, gamma-chlordane, and endrin) were detected and retained as COPCs in the sediment.

Twenty-one metals were detected in the sediment. Arsenic, barium, beryllium, chromium, iron, manganese, and nickel are not retained as COPCs because they do not exceed their respective SSVs. As presented above, calcium, magnesium, potassium, and sodium are not retained as COPCs. The remaining ten metals (aluminum, cadmium, cobalt, copper, lead, mercury, selenium, silver, vanadium, and zinc) are retained as COPCs.

7.3.3 Physical/Chemical Characteristics of COPCs

Physical and chemical characteristics of contaminants may affect their mobility, transport, and bioavailability in the environment. These characteristics include bioconcentration factors (BCFs), organic carbon partition coefficient (K_{oc}), octanol water partition coefficient (K_{ow}), and biotransfer factors (B_v, B_b, B_r). Table 7-5 summarizes these values for the COPCs detected in the surface soil, surface water and sediment. Information from these tables is used to assess the fate and transport of the contaminants and the potential risks to the environmental receptors at Site 43. The following paragraphs present the significance of each parameter included in the table.

Bioconcentration factors measure the tendency for a chemical to partition from the water column or sediment and concentrate in aquatic organisms. Bioconcentration factors are important for ecological receptors because chemicals with high BCFs could accumulate in lower-order species and subsequently accumulate to toxic levels in species higher up the food chain. The BCF is the concentration of the chemical in the organism at equilibrium divided by the concentration of the chemical in the water. Therefore, the BCF is unitless. The bioconcentration factor is used in the terrestrial intake model to estimate the COPC concentration in fish that may be ingested by the raccoon.

The organic carbon partition coefficient (K_{oc}) measures the tendency for a chemical to partition between soil or sediment particles containing organic carbon and water. This coefficient is important in the ecological environment because it determines how strongly an organic chemical will be bound to the organics in the sediments. The K_{oc} is used to calculate sediment quality criteria.

The octanol/water partition coefficient (K_{ow}) is the ratio of a chemical concentration in octanol divided by the concentration in water. The octanol/water partition coefficient has been shown to correlate well with bioconcentration factors in aquatic organisms and with adsorption to soil or sediment. The K_{ow} is used to calculate the plant and beef biotransfer factors (for organics) that are used to estimate the COPC concentration in plants and the small mammal that may be ingested by the terrestrial receptors in the intake model.

The plant biotransfer factors (B_v or B_r) measure the potential for a chemical to accumulate in a plant. These factors are used to calculate the concentration of the COPCs in the leafy part of the plant (B_v) or the fruit of the plant (B_r). The factors for inorganics are obtained from Baes et. al, (1984), while the factors for organics are calculated according to Travis and Arms (1988). The B_v and B_r values for the organics are assumed to be same value.

Finally, the beef biotransfer factor (B_b) measures the potential for a chemical to accumulate in an animal. This factor is used to calculate the COPC concentration in the small mammal that is ingested by the red fox. The factors for inorganics are obtained from Baes et. al, (1984), while the factors for organics are calculated according to Travis and Arms (1988).

7.4 Ecosystems Potentially at Risk

Ecological receptors that might be potentially at risk from contaminants at Site 43 were identified during the field investigations and the habitat evaluation. The regional ecology is presented in Section 1.0 of this RI, while the site specific ecology is presented in Section 2.0. Based on the results of the field investigations and the habitat evaluation, potential receptors of contaminants in surface water and sediment include the following: fish, benthic macroinvertebrates, other aquatic flora and fauna and some terrestrial faunal species. Potential receptors of contaminants in soil include the following: deer, rabbits, foxes, raccoons, birds and other terrestrial flora and fauna.

7.5 Ecological Endpoints

The information compiled during the first stage of problem formulation (stressor characteristics and ecosystems potentially at risk) is used to select the ecological endpoints for this ERA. There are two primary types of ecological endpoints: assessment endpoints and measurement endpoints. Assessment endpoints are environmental characteristics, which, if they are found to be significantly affected, may indicate a need for remediation (e.g., decrease in sports/fisheries). Measurement endpoints are quantitative expressions of an observed or measured effect of the contamination of concern. Measurement endpoints may be identical to assessment endpoints (e.g., measurement of abundance of fish), or they may be used as surrogates for assessment endpoints (e.g., toxicity test endpoints). Both types of endpoints are used in the ecological risk evaluation and are presented in the following sections.

A measurement endpoint, or "ecological effects indicator" as it is sometimes referred, is used to evaluate the assessment endpoint. Therefore, measurement endpoints must correspond to, or be predictive of, assessment endpoints. In addition, they must be readily measurable, preferably quickly and inexpensively, using existing techniques. Measurement endpoints must take into consideration the magnitude of the contamination and the exposure pathway. The measurement endpoint should be an indicator of effects that are temporally distributed. Low natural variability in the endpoint is preferred to aid in attributing the variability in the endpoint to the contaminant. Measurement endpoints should be diagnostic of the pollutants of interest, as well as broadly

applicable to allow comparison between sites and regions. Also, measurement endpoints should be standardized (e.g., standard procedures for toxicity tests). Finally, it is desirable to use endpoints that already are being measured (if they exist) to determine baseline conditions.

7.5.1 Aquatic Endpoints

The assessment endpoints for the aquatic receptors are potential decreases in the survival, growth, and/or reproduction of the aquatic receptor population or subpopulation that is attributable to site-related contaminants. The first measurement endpoint for the aquatic assessment endpoint includes decreased survival and growth of Pimephales promelas and Chironomus tentans, decreased survival and reproduction of Ceriodaphnia dubia, and decreased survival of Hyalella azteca as compared to controls. The second measurement endpoint is the exceedance of contaminant-specific surface water and sediment effect concentrations (i.e., SWSVs, and SSVs).

7.5.2 Terrestrial Endpoints

The assessment endpoint for the terrestrial receptors is the potential reduction of a receptor population or subpopulation that is attributable to contaminants from the site. The measurement endpoints for the terrestrial ERA include exceedances of contaminant-specific soil effect concentrations (i.e., SSSVs) and contaminant-specific effect doses (TRVs).

7.6 Conceptual Model

This section of the ERA presents each potential exposure pathway via soil, groundwater, surface water, sediment, and air, and the likelihood that an exposure will occur through these pathways. Figure 7-1 presents the flowchart of potential exposure pathways and ecological receptors.

To determine if ecological exposure via these pathways may occur in the absence of remedial actions, an analysis is conducted including the identification and characterization of the exposure pathways. The following four elements are examined to determine if a complete exposure pathway is present:

- A source and mechanism of chemical release
- An environmental transport medium
- A feasible receptor exposure route
- A receptor exposure point

7.6.1 Soil Exposure Pathway

Potential release sources to be considered in evaluating the soil pathway are surface or buried wastes and contaminated soil. The release mechanisms to be considered are fugitive dust, leaching, tracking, and surface runoff. The transport medium is the soil. The potential routes to be considered for ecological exposure to the contaminated soil are ingestion and dermal contact. Potential exposure points for ecological receptors include species living in, or coming in contact with, the soil. COPCs were detected in the surface soil demonstrating a release from a source to the surface soil transport medium. Potential receptors that may be exposed to contaminants in surface soil at/or around surface soil in the areas of detected COPCs include the following: deer, fox, raccoon, rabbits, birds, plants, and other terrestrial life.

Terrestrial receptors potentially are exposed to contaminants in the soil through ingestion, dermal contact, and/or direct uptake (for flora). The magnitude of the exposure depends on their feeding habits and the amount of time they reside in the contaminated soil. In addition, terrestrial species may ingest organisms that have bioconcentrated contaminants from the soil. This exposure pathway is likely to occur at Site 43 and will be retained for further analysis.

7.6.2 Groundwater Exposure Pathway

The potential release source to be considered in evaluating the groundwater pathway is contaminated soil. The release mechanism to be considered is leaching. The routes to be considered for ecological exposure to the contaminated groundwater are ingestion and dermal contact. Groundwater discharge to area surface waters may represent a pathway for contaminant migration.

Sub-surface biota (i.e., microorganisms) are the only ecological receptors expected to be directly exposed to groundwater. Potential impacts to these biota are not assessed in this ERA because current guidance does not provide sufficient information to evaluate risk. In addition, since the receptors of concern are not directly exposed to groundwater at Site 43, the groundwater to surface water exposure is accounted for in the surface water section of the ERA.

7.6.3 Surface Water and Sediment Exposure Pathway

Potential release sources to be considered in evaluating the surface water and sediment pathways are contaminated surface soil and groundwater. The release mechanisms to be considered are groundwater seepage and surface runoff. The potential routes to be considered for ecological exposure to the contaminated surface water/sediment are ingestion and dermal contact. Potential exposure points for ecological receptors include species living in, or coming in contact with, the surface water/sediment on-site or downgradient of the site. COPCs were detected in the surface water and sediment demonstrating a release from a source to the surface water or sediment transport medium. Potential receptors that may be exposed to contaminants in surface water and sediment include the following: fish, benthic macroinvertebrates, deer, birds, and other aquatic and terrestrial life.

Aquatic receptors are exposed to contaminants in the surface water and sediment by ingesting water while feeding and by direct contact while feeding or swimming. This exposure pathway is likely to occur at Site 43 and will be evaluated in the ERA. In addition, aquatic organisms may ingest other aquatic flora and fauna that have bioaccumulated chemicals from the surface water and sediment. This potential exposure pathway will not be evaluated in the ERA because current guidance does not provide sufficient information to evaluate risk.

Terrestrial faunal receptors potentially are exposed to contaminants in the surface water and sediment through ingestion and dermal contact. The magnitude of the exposure depends on their feeding habits and the amount of time they reside in the contaminated waters. In addition, terrestrial species may ingest organisms (e.g., fish, small mammals, invertebrates, and plants) that have bioconcentrated contaminants from the surface water and sediment. These exposure pathways are likely to occur at Site 43. However, only the surface water and surface soil ingestion pathway will be evaluated in the ERA. Current guidance does not exist to evaluate the sediment pathway or dermal contact pathway for terrestrial receptors, therefore, these pathways will not be evaluated in the ERA.

7.6.4 Air Exposure Pathway

There are two potential release mechanisms to be considered in evaluating the atmospheric pathway: release of contaminated particulates and volatilization from surface soil, groundwater and surface water. The potential exposure points for receptors are areas on or adjacent to the site. The air exposure pathway is not evaluated in this ERA because air sampling was not conducted, and current guidance does not provide sufficient information to evaluate risk

7.7 Exposure Assessment

The next phase after the problem formulation is the exposure assessment that consists of quantifying the potential exposure of the stressors (COPCs) to the ecological receptors.

The RI included collecting samples for analytical analysis from four media; soil, groundwater, surface water, and sediment. As presented earlier in the ERA, contaminants in the subsurface soil and groundwater are not evaluated. The analytical results for the data used in ERA are presented in Section 4.0 of this report.

The regional ecology, site ecology, and habitat characterization in the areas surrounding Site 43 are presented in Sections 1.0 and 2.0 of this report. Information on sensitive environments and endangered species also is included in this section. Exposure of contaminants in the surface soil to terrestrial flora and fauna (invertebrates and microorganisms) are assumed to be equal to the contaminant concentration in the surface soil. It is noted in the uncertainty section of this ERA that all the contaminants in the surface soil may not be bioavailable to the terrestrial flora or fauna. Exposure of contaminants in the surface water and sediment to aquatic receptors are assumed to be equal to the contaminant concentration in the surface water and sediment. Exposure of contaminants in the surface soil and surface water to other terrestrial fauna (mammals, birds) is estimated using chronic daily intake models (see Section 7.8.5 of this report).

The following sections present the results of the ecosystem characterization including the biological sampling, abiotic habitat, and biotic habitat.

7.7.1 Surface Water, Sediment, and Bioassay Sampling

Water quality measurements were collected during the surface water, sediment, and bioassay sampling event prior to the sample collection. These measurements consisted of temperature, pH, specific conductance, salinity, and dissolved oxygen. Site specific descriptions, and field water quality measurements were recorded on field data sheets (see Appendix S). The station locations and sampling procedures for collecting each of the environmental media are presented in Section 2.0 of this report.

7.7.1.1 Abiotic Habitat

The abiotic habitat consists of the description of the stations with regard to size of the creek, depth of the water, substrate type, water chemistry and other such non-biological descriptors. The following sections present the abiotic habitat for the sampling stations at Site 43.

Table 7-6 presents the sampling station characterization summary that includes the stream width and depth, canopy cover, sediment type, and sediment odor of the Site 43 stations and the upstream

stations. The stream width ranged from 5 to 50 feet, while the stream depth ranged from 0.5 to 1 feet. The canopy cover ranged from shaded to open. Finally, the sediment ranged from a medium to fine sand, to a silty muck with organic material. Sediment odors ranged from normal to strong anaerobic.

Table 7-7 presents the results of the field chemistry including the temperature, pH, dissolved oxygen concentration, conductivity, and salinity. The temperature ranged from 18.3 to 22 °C, the pH ranged from 6.53 to 8.67 S.U., the dissolved oxygen ranged from 3.6 to 13.7 mg/L, the conductivity ranged from 788 to 10,600 umhos/cm, and the salinity ranged from 0.3 to 7.0 ppt. The field chemistry at these stations appears to be typical of surface waters at MCB, Camp Lejeune based on Baker's previous sampling experience.

7.7.1.2 Bioassay Procedures

Baker Environmental, Inc. (Baker) contracted with RMC Environmental Services, Inc. (RMC) to conduct surface water and sediment bioassays for one sample collected in Strawhorn Creek. Appendix V contains the laboratory methods used to conduct the bioassays.

RMC conducted 7-day survival and growth bioassays using the fathead minnow (Pimephales promelas), and survival and reproduction bioassays using the cladoceran (Ceriodaphnia dubia) with the surface water sample. The tests were conducted following procedures outlined in the following documents: Methods for Measuring the Acute Toxicity of Effluents to Freshwater and Marine Organisms, Fourth Edition (USEPA, 1990) and Short-Term Methods for Estimating the Chronic Toxicity of Effluents and Receiving Waters to Freshwater Organisms (USEPA, 1989d).

Fathead minnow larvae and young C. dubia (<24 hr old at test initiation) were exposed to the surface water samples for 7 days under static renewal conditions (i.e., the test solution was replaced daily with freshly prepared solution). The tests were conducted with 100 percent sample, along with sample dilutions of 50 percent, 25 percent, 12.5 percent, and 6.25 percent. A control sample consisting of 100 percent dilution water also was tested. Survival of the minnows was recorded daily while the growth of the minnows (as weight gain/loss) was recorded at the end of 7 days. Survival and reproduction of the C. dubia were recorded daily.

RMC conducted 10-day chronic survival bioassays using the amphipod Hyaella azteca, and growth and survival bioassays using the midge Chironomus tentans with the sediment sample. The tests were conducted in accordance with the Methods for Measuring the Toxicity and Bioaccumulation of Sediment Associated Contaminants with Freshwater Invertebrates, (USEPA, 1994b).

Ten day old H. azteca and third instar C. tentans were exposed to the sediment samples for ten days under static renewal conditions. The overlying water was replaced twice daily, however, the sediment was not replaced or diluted. Survival of the H. azteca, and survival and growth (as weight gain/loss) of the C. tentans were recorded at the end of 10 days.

RMC used moderately hard reconstituted water for the surface water control, dilution water, and the overlying water for the sediment samples. Baker provided RMC with a sediment sample from Frenchs Creek (assumed to be uncontaminated) that was used as the control sediment. The bioassay results of the Site 43 samples were statistically compared to the bioassay results of the control samples to determine if there was a statistically significant difference in effects (i.e., survival, growth, reproduction) between the samples.

7.7.1.3 Bioassay Results

The three measurement endpoints for the surface water bioassays are the No Observed Effect Concentration (NOEC), the Lowest Observed Effect Concentration (LOEC), and the Lethal Concentration for 50 percent of the test organisms (LC₅₀). The NOEC is the highest sample concentration that does not show a significant difference in effects between the site sample and the control sample. For example, a NOEC of 100 percent sample indicates that the survival or growth of fathead minnow is not significantly different between the undiluted (100 percent) site sample and the control sample. The LOEC is the lowest sample concentration that shows a statistical difference in effects between the site sample and the control sample. For example, a LOEC of 50 percent sample for the fathead minnow indicates that there is a significant difference in growth or survival between the site sample (diluted by 50 percent) and the control sample. Finally, the LC₅₀ is the sample concentration that is expected to be lethal to half of the test organisms in a given time period. The LC₅₀ is calculated using on the survival data. The table below summarizes the results of the surface water bioassays.

Species	Survival		Growth		Reproductive		LC50
	NOEC	LOEC	NOEC	LOEC	NOEC	LOEC	
<u>P. promelas</u>	100%	100%	100%	100%	NM	NM	100%
<u>C. dubia</u>	50%	100%	NM	NM	25%	50%	53.6%

Note: All values in percentage of sample

NM = Not Measured

NOEC = No Observed Effects Concentration

LOEC = Lowest Observed Effects Concentration

LC₅₀ = Lethal Concentration of 50% of the test organisms over a given time period

The results of the bioassays indicate that survival and growth of the P. promelas is not significantly different from the control in undiluted sample. However, there is a significant difference in survival of C. dubia between the control sample and the diluted (100 percent) Site 43 sample (LOEC), while no significant survival effect is observed between the control sample and the diluted (50 percent) Site 43 sample (NOEC). There is a significant difference in reproduction of C. dubia between the control sample and the diluted (50 percent) Site 43 sample, while no significant reproductive effect is observed between the control sample and the diluted (25 percent) Site 43 sample (NOEC). The 100 percent site sample was not included in the reproduction evaluation since there was a significant survival effect in this sample. Finally, the 48 hr LC₅₀ is 53.6 percent sample for P. promelas and the C. dubia.

Current procedures for sediment bioassays do not allow for the dilution of sediment with clean sediment to test the effects of different sediment concentrations. Therefore, it is not possible to calculate a NOEC, LOEC or LC₅₀. The sediment bioassay revealed a significant difference in survival of H. azteca between the control sample and the Site 43 sample, however, no significant difference was observed in the survival or growth of C. tentans between the control sample and the Site 43.

7.8 Ecological Effects Characterization

The ecological effects data that were used to assess potential risks to aquatic and/or terrestrial receptors in this ERA include aquatic and terrestrial screening values as presented in Section 7.3.2 to aid in the selection of the COPCs. The following sections present a summary of the ecological effects comparison.

7.8.1 Surface Water

Contaminant concentrations detected in the surface water at Site 43 were compared to the saltwater SWSVs to determine if there were any exceedances of the published values (see Tables 7-1 and 7-2).

In summary, copper (total), manganese (total and dissolved), 4,4'-DDD and 4,4'-DDE were the only contaminants that exceeded any of the SWSVs. No saltwater SWSVs were available for aluminum, barium, or iron.

In the Quality Criteria for Water-1986, it is reported that soluble barium concentrations in marine waters generally would have to exceed 50,000 µg/L before toxicity to aquatic life would be expected (USEPA, 1987). Therefore, the maximum barium concentrations in the surface water samples (36.5 µg/L-total, and 35.2 µg/L-dissolved), are below the concentrations that are expected to cause adverse impacts to aquatic life.

The source for the SWSV for manganese of 10 µg/L is not known. However, AQUIRE reports that 10 µg/L caused decreased growth in the pacific oyster (*Crassostrea gigas*). This study, which did not meet the criteria for reliability, may be the data source for the Region III value. Other toxicity values for manganese from AQUIRE listed adverse effects at 20,000 µg/L which is higher than the maximum sample concentration collected at Site 43 (57.1 µg/L). These studies also were conducted with mollusk species.

The concentrations of total iron (670J-4,280J µg/L) and dissolved iron (942J-1,330J µg/L) in the surface water are above the concentrations that caused adverse impacts to aquatic life of some of the studies obtained from the Aquatic Information Retrieval Database (AQUIRE) (100 to 330,000 µg/L). However, the majority of the effect concentrations from the studies on AQUIRE are several orders of magnitude above the maximum iron concentration detected in the surface water. Most of the studies on iron in AQUIRE were conducted with various marine phytoplankton cultures.

Finally, it should be noted that the concentration of dissolved copper did not exceed the SWSVs in any of the samples, and aluminum was not detected in the dissolved samples. This is significant in that it is generally regarded among the scientific community that dissolved metal more closely approximates the bioavailable fraction of metal in the water column than does total recoverable metal (USEPA, 1993g).

7.8.2 Sediment

Contaminant concentrations detected in the sediment at Site 43 were compared to SSVs to determine if there were any exceedances of the published values (see Table 7-3). Benzo(a)pyrene, and bis(2-ethylhexyl)phthalate are the only SVOCs that exceeded a SSV. Alpha-chlordane, gamma-chlordane, 4,4'-DDD, 4,4'-DDE, 4,4'-DDT, and endrin are the only pesticides that exceeded a SSV. Cadmium,

copper, lead, mercury, selenium, silver, and zinc are the only inorganics that exceeded a SSV. No SSVs are available for acetone, carbon disulfide, aluminum, cobalt, or vanadium.

7.8.4 Surface Soil

Although promulgated standards do not exist, Surface Soil Screening Values (SSSVs) that can be used to evaluate potential ecological risks to terrestrial flora and fauna have been developed by USEPA Region III (USEPA, 1995b) and Oak Ridge National Laboratory (Will and Suter, 1994a, 1994b). The contaminant concentrations in the surface soils are compared to the SSSVs to determine if potential impacts to terrestrial flora and fauna invertebrates may be expected (see Table 7-8).

Several SVOCs, pesticides, and inorganics were detected in the surface soil at concentrations exceeding the SSSVs. Much of the study area at Site 43 is heavily vegetated with dense understory and trees greater than three inches in diameter. Therefore, ecological receptors have a high potential for becoming exposed to contaminants in the surface soil.

7.8.5 Terrestrial Chronic Daily Intake Model

In addition to comparing the soil concentrations to toxicity values for terrestrial invertebrates and plants, a terrestrial Chronic Daily Intake (CDI) Model is used to estimate the exposure of the COPCs to terrestrial receptors. The following describes the procedures used to evaluate the potential soil exposure to terrestrial fauna at Site 43 by both direct and indirect exposure to COPCs via surface soil, surface water, and foodchain transfer.

Based on the regional ecology and potential habitat at the site, the indicator species used in this analysis are the white-tailed deer, cottontail rabbit, red fox, raccoon, and the bobwhite quail. The exposure points for these receptors are the surface soil, surface water, and biota. The routes for terrestrial exposure to the COPCs in the soil and water are incidental soil ingestion, drinking water, vegetation (leafy plants, seeds and berries) ingestion, fish ingestion, and ingestion of small mammals.

7.8.5.1 Derivation of Terrestrial Reference Value

Total exposure of the terrestrial receptors to the COPCs in the soil and surface waters is determined by estimating the CDI dose and comparing this dose to Terrestrial Reference Values (TRVs) representing acceptable daily doses in mg/kg/day. The TRVs were developed from No-Observed-Adverse-Effect-Levels (NOAELs) or Lowest-Observed-Adverse-Effect-Levels (LOAELs) obtained from the Integrated Risk Information System (IRIS), Agency for Toxic Substances and Disease Registry Toxicological Profiles, mineral tolerance levels of domestic animals (NAS, 1992) or other toxicological data in the literature. Appendix W presents the methodology used in deriving the TRVs and the animals that were used to derive each TRV.

7.8.5.2 Calculation of Chronic Daily Intake

Potential impacts of the terrestrial receptors to the COPCs in the soil and surface water are determined by estimating the CDI dose and comparing this dose to TRVs representing acceptable daily doses in mg/kg/day. The CDI equations were adapted from those used in Scarano et. al.,

(1993). The estimated CDI dose of the bobwhite quail, cottontail rabbit, white-tailed deer and small mammal, to soil, surface water, and vegetation is determined using the following equation:

$$CDI = \frac{(C_w)(I_w) + [(C_s)(B_v)(I_v) + (C_s)(I_s)][H]}{BW}$$

Where:

CDI	=	Chronic Daily Intake, mg/kg/d
C _w	=	Contaminant concentration in the surface water, mg/L
I _w	=	Rate of drinking water ingestion, L/d
C _s	=	Contaminant concentration in soil, mg/kg
B _v	=	Soil to plant transfer coefficient (leaves, stems, straw, etc.), unitless
I _v	=	Rate of vegetation ingestion, kg/d
I _s	=	Incidental soil ingestion, kg/d
H	=	Contaminated area/Home area range area ratio, unitless
BW	=	Body weight, kg

To calculate the contaminant concentration in the small mammal, the resulting CDI from the above equation is multiplied by the biotransfer factor for beef (B_b) for organics (Travis and Arms, 1988) and metals (Baes, et. al., 1984).

The estimated CDI dose of the raccoon is determined using the following equation.

$$CDI = \frac{(C_w)(I_w) + (C_f)(I_f) + [(C_s)(B_r)(I_v) + (C_s)(I_s)][H]}{BW}$$

Where:

CDI	=	Chronic Daily Intake, mg/kg/d
C _w	=	Contaminant concentration in the surface water, mg/L
I _w	=	Rate of drinking water ingestion, L/d
C _f	=	Contaminant concentration in the fish, mg/kg
I _f	=	Rate of fish ingestion, kg/d
C _s	=	Contaminant concentration in soil, mg/kg
B _r	=	Soil to plant transfer coefficient (fruit, seeds, tubers, etc.), unitless
I _v	=	Rate of vegetation ingestion, kg/d
I _s	=	Incidental soil ingestion, kg/d
H	=	Contaminated area/Home area range area ratio, unitless
BW	=	Body weight, kg

The contaminant concentration in the fish is calculated by multiplying the bioconcentration factor by the surface water concentration.

The estimated CDI dose of the red fox is determined using the following equation:

$$CDI = \frac{(C_w)(I_w) + [(C_s)(B_v)(I_v) + (C_s)(I_s) + (C_m)(I_m)][H]}{BW}$$

Where:

CDI	=	Chronic Daily Intake, mg/kg/d
Cw	=	Contaminant concentration in the surface water, mg/L
Iw	=	Rate of drinking water ingestion, L/d
Cs	=	Contaminant concentration in soil, mg/kg
Bv	=	Soil to plant transfer coefficient (leaves, stems, straw, etc.), unitless
Iv	=	Rate of vegetation ingestion, kg/d
Is	=	Incidental soil ingestion, kg/d
Cm	=	Contaminant concentrations in small mammals, mg/kg
Im	=	Rate of small mammal ingestion, kg/d
H	=	Contaminated area/Home area range area ratio, unitless
BW	=	Body weight, kg

Bioconcentration of the COPCs to plants is calculated using the soil to plant transfer coefficient (Bv or Br) for organics (Travis and Arms, 1988) and metals (Baes et. al., 1984). The concentrations of the COPCs used in the models are the lower of the upper 95 percent confidence limit or the maximum concentration detected of each COPC. The exposure parameters used in the CDI calculations are presented in Table 7-9.

7.9 Risk Characterization

The risk characterization is the final phase of a risk assessment. It is at this phase that the likelihood of adverse effects occurring as a result of exposure to a stressor is evaluated. This section evaluates the potential decrease in aquatic and terrestrial populations at Site 43 from contaminants identified at the site.

A Quotient Index (QI) approach is used to characterize the risk to aquatic receptors from exposure to contaminants in the surface water and sediment and terrestrial receptors from exposure to contaminants in the surface soil, surface water, and biota. This approach characterizes the potential effects by comparing exposure levels of COPCs in the surface water and sediments to the aquatic reference values presented in Section 7.8, Ecological Effects Characterization. The QI is calculated as follows:

$$QI = \frac{(EC \text{ or } CDI)}{(SWSV, SSV, \text{ or } TRV)}$$

Where:

Quotient Index

EC = Exposure Concentration, $\mu\text{g/L}$, $\mu\text{g/kg}$ or mg/kg

CDI = Chronic Daily Intake, mg/kg/day

SWSV = Surface Water Screening Value, $\mu\text{g/L}$

SSV = Sediment Screening Value, $\mu\text{g/kg}$ or mg/kg

TRV = Terrestrial Reference Value, mg/kg/day

A QI of greater than "unity" is considered to be indicative of potential risk. Such values do not necessarily indicate that an effect will occur but only that a lower threshold has been exceeded. It is important to determine which contaminants are posing the highest risks, in order to evaluate the significance of those contaminants to the site. Therefore, the evaluation of the significance of the QI has been judged as follows: (Menzie et. al., 1993)

- QI exceeds "1" but less than "10": some small potential for environmental effects
- QI exceeds "10": significant potential that greater exposures could result in effects based on experimental evidence
- QI exceeds "100": effects may be expected since this represents an exposure level at which effects have been observed in other species

The risks characterized above provide insight into general effects upon animals and plants in the local population. However, depending on the endpoint selected, they may not indicate if population-level effects will occur.

7.9.1 Surface Water

Table 7-10 presents the surface water QIs. Figure 7-2 graphically displays the QIs that exceed "1". See Appendix U for the QI calculations. In summary, copper (total), manganese (total and dissolved), 4,4'-DDD and 4,4'-DDE were the only surface water COPCs with QIs greater than "1". The copper and manganese QIs were less than "10". The QIs for the two pesticides ranged from "95 to 640".

7.9.2 Sediment

Table 7-11 presents the surface water QIs. Figure 7-2 graphically displays the QIs that exceed "1". See Appendix U for the QI calculations. The SQC QIs for the organics are calculated on a per-station basis using the sample-specific TOC values. When TOC was not collected in a specific sample, the lowest TOC value in that waterbody was used to calculate the SQC. Benzo(a)pyrene, and bis(2-ethylhexyl)phthalate were the only SVOCs with QIs that exceeded "1". All the QIs were less than "5". Therefore, only a slight risk to aquatic receptors are expected from the concentration of SVOCs in the sediment.

Alpha-chlordane, gamma-chlordane, 4,4'-DDD, 4,4'-DDE, 4,4'-DDT, and endrin were the only pesticides detected in the sediment samples with QIs that exceeded "1". Most of the samples had ER-M and SQC QIs that were less than "10". However, several samples had QIs that exceeded "1,000", with a maximum QI of "18,500". The highest areas of contamination are located at Stations 43-EC-SD01, 43-EC-SD02, 43-SHC-SD03, and 43-SHC-SD04. Therefore, the risk to aquatic receptors from concentrations of pesticides are expected to be high.

Cadmium, copper, lead, mercury, selenium, silver, and zinc are the only inorganics detected in the sediment samples with QIs that exceed "1". All the ER-L QIs were less than "5", while the ER-M QIs were all less than "1". Therefore, only a slight risk to aquatic receptors are expected from the concentration of inorganics in the sediment.

7.9.3 Terrestrial Chronic Daily Intake Model

Table 7-12 presents the QI for the terrestrial CDI model. Appendix W contains the CDI spreadsheets. The bobwhite quail (QI=1.3), cottontail rabbit (QI=11.7) and the raccoon (QI=25.1) are the only species with QIs that exceeded "1". Aluminum (QI=14.8), bis(2-ethylhexyl)phthalate (QI=6.6), and 4,4'-DDD (QI=2.6) are the COPCs that account for the majority of the QI value in the raccoon. Aluminum (QI=2.1), barium (QI=1.3), cadmium (QI=1.9) and zinc (QI=2.1) are the

COPCs that account for the majority of the QI value in the rabbit. No other COPCs for any of the species had individual QIs that exceeded "1".

7.10 Ecological Significance

This section essentially summarizes the overall risks to the ecology at the site. It addresses impacts to the ecological integrity at Site 43 from the COPCs detected in the media, and determines which COPCs are impacting the site to the greatest degree, and what site-related contaminants are "significant". This information, to be used in conjunction with the human health risk assessment, supports the selection of remedial action(s) for Site 43 that are protective of public health and the environment.

7.10.1 Aquatic Endpoints

The concentration of total and dissolved iron are above the concentrations reported to cause adverse impacts to marine phytoplankton. However, there is not enough toxicological data to determine if the detected concentration of iron in the surface water are expected to cause a decrease in the aquatic receptor population. Total copper just slightly exceeded the SWSVs, however, it was not detected in the dissolved surface water samples. Therefore, copper is not expected to cause a decrease in the aquatic receptor population.

Manganese was the only inorganic COPC detected in the dissolved surface water samples that exceeded a SWSV. The source of the screening value appears to come from a study causing decreased growth in the pacific oyster. Other studies conducted with mollusks determined adverse effects to occur at significantly higher manganese levels than were detected at Site 43. In addition, manganese reportedly was not disposed, stored, or used at Site 43. Therefore, although manganese potentially may cause a decrease in the aquatic receptor population, it's presence in the surface water does not appear to be site-related.

The pesticides 4,4'-DDD and 4,4'-DDE were the only organics detected in the surface water samples that exceeded a SWSV. The samples were collected at locations where the highest concentrations of these pesticides were detected in the sediment (43-EC-SW/SD01, 43-SHC-SW/SD03, and 43-SHC-SW/SD04). Therefore, there is a high probability for a decrease in the aquatic receptor population from pesticides in the surface water and sediment. The source of the pesticides is not known since pesticides reportedly were not stored or disposed at Site 43. The high pesticide concentration in the surface water and sediment may be due to disposal of excess materials during the periodic pesticide spraying that occurred on the base.

Several inorganics were detected in the sediments at concentrations that exceeded the ER-L. However, none of the inorganics exceeded the ER-M. All the ER-L QIs were less than "5". Therefore, there only is a slight potential for a decrease in the aquatic receptor population from inorganics in the sediment.

The bioassay samples were collected at station 43-SHC-SW/SD04. This station had the highest concentration of pesticides in the sediment, and a relatively high pesticide concentration in the surface water. For the surface water bioassay, adverse survival and reproductive effects were observed in the *C. dubia* bioassay. However, no adverse survival or growth effects were observed in the fathead minnow bioassay. The difference in results between the two samples may be due to interspecies differences in sensitivities to the contaminants in the surface water. In addition, it was

reported in a personal communication with Region IV USEPA, that USEPA had determined that salinities above 2 parts per thousand (ppt) cause reproductive effects in the C. dubia. The C. dubia also has an LC50 of 8 ppt salinity. Therefore, it is likely that at least part of the adverse effects in the surface water sample collected at Site 43 were due to the salinity, which ranged from 5 to 6 ppt. The fathead minnow is not as sensitive to salinity as the C. dubia.

For the sediment bioassay, decreased survival of H. azteca was observed in the Site 43 sample; however, no decrease in survival or growth of C. tentans was observed in the Site 43 sample. The decrease in survival of H. azteca may be caused by the high pesticide concentrations detected in the sediment

7.10.2 Terrestrial Endpoints

Several SVOCs, pesticides, and metals were detected in the surface soil at concentrations that exceed the SSSVs. No SSSVs were available for some of the COPCs, therefore, potential adverse impacts to terrestrial invertebrates and plants from these contaminants could not be evaluated. Much of the study area at Site 43 is heavily vegetated with dense understory and trees greater than three inches in diameter. Therefore, ecological receptors have a high potential for becoming exposed to contaminants in the surface soil.

The bobwhite quail (QI=1.3), cottontail rabbit (QI=11.7), and the raccoon (QI=25.1) are the only terrestrial species with estimated CDI values that exceeded the TRV values. Aluminum and 4,4'-DDD in the raccoon model, and aluminum, barium, cadmium, and zinc in the cottontail rabbit model, contributed the majority of the exceedences in these models. With the exception of aluminum in the raccoon model, all the individual COPC QIs are less than "3", indicating that risk to terrestrial species from these contaminants is expected to be low. The high aluminum QI for the raccoon is due the high BCF value of aluminum, and the assumption that the raccoon will eat all of it's fish from Site 43. This is a very conservative assumption. Therefore, probable risk to the raccoon from aluminum is expected to be low.

7.10.3 Threatened and Endangered Species

No threatened or endangered species are present at Site 43.

7.10.4 Wetlands

As presented on the Biohabitat Map in Section 2.0, several wetland areas are present at Site 43. The wetlands border Edwards Creek and the Unnamed Tributary on both sides. The only samples collected in the wetlands were collected in the surface water and sediment in the waterbodies adjacent to the wetlands. Potential impacts to aquatic and terrestrial receptors exposed to contaminants in these media are evaluated in other sections of this ERA.

7.11 Uncertainty Analysis

The procedures used in this evaluation to assess risks to ecological receptors, as in all such assessments, are subject to uncertainties. The following discusses some of the uncertainty in this ERA.

The chemical sampling program at Site 43 consisted of six surface water samples, and twelve saltwater sediment samples. Because there were less than twenty samples, contaminants could not be eliminated because of infrequency. Therefore, contaminants not related to the site may have been retained as COPCs and thus carried through the ERA.

There is uncertainty in the ecological endpoint comparison. The SWSVs (WQS and AWQC) are established to be protective of a majority of the potential receptors. However, some species may not be protected by the values because of their increased sensitivity to the chemicals. In addition, most of the values are established using laboratory tests, where the concentrations of certain water quality parameters (pH, hardness, total organic carbon) that may influence toxicity are most likely at different concentrations in the site water.

Potential adverse impacts to aquatic receptors from contaminants in the sediments were evaluated by comparing the COPC concentration in the sediments to SSVs. These SSVs have more uncertainty associated with them than do the SWSVs, since the procedures for developing them are not as established as those used in developing SWSLs. In addition, sediment type (pH, acid volatile sulfide, total organic carbon) also has a significant impact on the bioavailability and toxicity of contaminants.

Potential adverse impacts to terrestrial invertebrates and plants were evaluated by comparing the COPC concentration in the soil to SSSVs. Most of these studies do not account for the soil type, which may have a large influence on the toxicity of the contaminants. For example, soil with high organic carbon content will tend to sorb many of the organic COPCs, thus making them less bioavailable to terrestrial receptors. In addition, most of the SSSVs are based on one or two studies, which greatly adds to their uncertainty.

There are some differences of opinion found in the literature as to the effectiveness of using models to predict concentrations of contaminants found in terrestrial species. According to one source, the food chain models currently used incorporate simplistic assumptions that may not represent actual site conditions, bioavailability of contaminants, or site-specific behavior of the receptors. Simple food chain models can provide an effective means of initial characterization of risk, however, residue analyses, toxicity tests, and the use of biomarkers provide a better approach for assessing exposure (Menzie et. al., 1993).

There are several sources of uncertainty when using these models. First, most of the terrestrial reference values are based on toxicity data from another species, which is then extrapolated to the species of concern using a body-size scaling equation. Since the toxicity of all contaminants may not be proportional to body size, the calculated TRVs may not accurately predict risk to the species of concern. Another source of uncertainty with the models is that many of the input parameters are based on default values (i.e., ingestion rate) that may or may not adequately represent the actual values of the parameters. In addition, there is uncertainty in the amount that the indicator species will represent other species potentially exposed to COPCs at the site. There is uncertainty in use of the bioconcentration and biotransfer factors. Bioconcentration and biotransfer factors can vary widely from species to species. The species used in the calculation of the bioconcentration and biotransfer factors are different than the species that actually occur at the site. Therefore, use of the factors will tend to either overestimate or underestimate actual bioaccumulation of contaminants. Finally, terrestrial receptors also may be exposed to contaminants in the sediments. However, currently, there is no guidance in the literature that can be used to evaluate this potential exposure pathway.

The toxicity of chemical mixtures is not well understood. All the toxicity information used in the ERA for evaluating risk to the ecological receptors is for individual chemicals. Chemical mixtures can affect the organisms very differently than the individual chemicals due to synergistic or antagonistic effects. In addition, the species that were used to develop the toxicity data may not be present at the site, or have the potential to exist at the site. Depending on the sensitivity of the tested species to the species at the site use of the toxicity values may overestimate or underestimate risk. Many chemicals are not acutely toxic, however, they have the potential to bioaccumulate in ecological receptors through food chain transfer. This bioaccumulation potential typically is not taken into account when comparing contaminant concentrations to screening values.

Finally, toxicological data for several of the COPCs were limited or do not exist. Therefore, there is uncertainty in any conclusions involving the potential impacts to aquatic receptors from these contaminants

7.12 Conclusions

7.12.1 Aquatic Ecosystem

As presented earlier in the ERA, the assessment endpoints for the aquatic receptors are potential decreases in the survival, growth, and/or reproduction of the aquatic receptor population or subpopulation that is attributable to site-related contaminants. These assessment endpoints are evaluated using a series of measurement endpoints. This section of the ERA examines each of the measurement endpoints to determine if the assessment endpoints are impacted.

The first measurement endpoint is decreased survival and growth of P. promelas and C. tentans, decreased survival and reproduction of C. dubia, and decreased survival of H. azteca, all as compared to controls. The bioassay samples were collected at station 43-SHC-SW/SD04 in an area of the highest pesticide concentrations in the sediment, and a relatively high pesticide concentration in the surface water. Concentrations of manganese slightly exceeded the SWSVs at this station. For the surface water bioassay, adverse survival and reproductive effects were observed in the C. dubia bioassay. However, no adverse survival or growth effects were observed in the fathead minnow bioassay. It was reported in a personal communication with Region IV USEPA, that salinities above 2 parts per thousand (ppt) cause reproductive effects in the C. dubia and that it has an LC50 of 8 ppt salinity. Therefore, it is likely that at least part of the adverse effects in the surface water sample collected at Site 43 were due to the salinity (which ranged from 5 to 6 ppt), the pesticides and/or manganese. The fathead minnow is not as sensitive to salinity as the C. dubia. For the sediment bioassay, decreased survival of H. azteca was observed in the Site 43 sample. However, no decrease in survival or growth of C. tentans was observed in the Site 43 sample. The pesticide concentrations in the sediment may be causing the decrease in survival of H. azteca.

The second measurement endpoint is determining if the contaminant concentrations in the surface water and sediment exceed the contaminant-specific surface water and sediment effect concentrations (i.e., SWSVs, and SSVs). Several metals, SVOCs, and pesticides were detected in the surface water and/or sediment at concentrations above the SWSVs or SSVs. Based on the screening value comparison, there is a high potential for a decrease in the population of aquatic receptors from pesticides in the surface water and sediment. There is only a low potential for a decrease in the population of aquatic receptors from metals in the surface water and sediment and SVOCs in the sediment. The source of the pesticides is not known since pesticides reportedly were

not stored or disposed at Site 43. The pesticides may be associated with the base-wide spraying that occurred in the past.

7.12.2 Terrestrial Ecosystem

As presented earlier in the ERA, the assessment endpoints for the terrestrial receptors is the potential reduction of a receptor population or subpopulation that is attributable to contaminants from the site. This section evaluates this assessment endpoint using the measurement endpoints.

The first measurement endpoint is determining if there is an exceedance of contaminant-specific soil effect concentrations (i.e., SSSVs). Several SVOCs, pesticides, and metals were detected in the surface soil at concentrations that exceed the SSSVs. Much of the study area at Site 43 is heavily vegetated with dense understory and trees greater than three inches in diameter. Therefore, ecological receptors have a high potential for becoming exposed to contaminants in the surface soil.

The second measurement endpoint is determining if the terrestrial CDI exceeds the TRVs. The bobwhite quail, cottontail rabbit and the raccoon are the only terrestrial species with estimated CDI values that exceeded the TRV values. The individual COPCs QIs are relatively low (with the exception of aluminum in the raccoon model), indicating that risk to terrestrial species from these contaminants is expected to be low. The actual risk to the raccoon from aluminum is expected to be low, based on the conservative assumption in the model that the raccoon will eat all of its fish from Site 43.

Overall, some potential impacts to soil invertebrates and plants may occur as a result of site-related contaminants. It should be noted that there is much uncertainty in the SSSVs. A potential decrease in the terrestrial vertebrate population from site-related contaminants is not expected based on the terrestrial intake model.

7.13 References

Arthur and Alldredge. 1979. Public Health Evaluation and Ecological Assessment. Martin Marrietta Astronautics Group, Waterton Facility, Vol. II of III, Appendix A and B. Cited in Scarano, 1993.

Baes, C.F., Sharp, A.L., and R.W. Shor. September 1984. "Review and Analysis of Parameters for Assessing Transport of Environmentally Released Radionuclides through Agriculture." Oak Ridge National Laboratory.

Beyer, N., E. Connor, and S. Gerould. 1993. "Estimates of Soil Ingestion by Wildlife". Patuxent Wildlife Research Center, Laurel, MD.

Dee, J.C. November, 1991. "Methodology For Assessing Potential Risks To Deer Populations: A Case Study at a Superfund Site". Paper presented at the 1991 Annual Meeting of the Society of Environmental Toxicology and Chemistry. Abstract No. 426.

Fitchko, J. 1989. Criteria for Contaminated Soil/Sediment Cleanup. Pudvan Publishing Company, Northbrook, Illinois.

Long, E.W., D.D. Macdonald, S.L. Smith, and F.D. Calder. 1995. "Incidence of Adverse Biological Effects within Ranges of Chemical Concentrations in Marine and Estuarine Sediments." *Environmental Management* Vol. 19, No.1, pp. 81-97.

Long, E.R and Morgan, L.G. 1991. The Potential for Biological Effects of Sediment-Sorbed Contaminants Tested in the National Status and Trends Program. National Oceanic and Atmospheric Administration Technical Memorandum NOS OMA 52.

Menzie, C.A., Cura J. and J. Freshman. January 1993. Evaluating Ecological Risks and Developing Remedial Objectives at Forested Wetland Systems in New England. Paper contained in: Application of Ecological Risk Assessment To Hazardous Waste Site Remediation. Water Environmental Federation.

Montgomery, J.H. and L.M. Welton. 1990. Groundwater Chemicals Desk Reference. Lewis Publishers, Inc. Chelsea, Michigan.

Nagy, Kenneth. 1987. "Field Metabolic Rate and Food Requirement Scaling in Mammals and Birds. *Ecological Monographs*." 57(2). pp. 111-128.

NAS. 1992. Subcommittee on Mineral Toxicity in Animals. Mineral Tolerance of Domestic Animals. National Academy of Sciences. Washington, D.C. pp 5-7.

NC DEHNR. 1994. 15A NCAC 2b.0200 - Classifications and Water Quality Standards Applicable to Surface Waters of North Carolina. State of North Carolina Department of Health and Natural Resources. June 1, 1994.

Opresko, D.M., B.E. Sample, and G.W. Suter II. 1994. Toxicological Benchmarks for Wildlife, 1994 Revisions. Prepared for the US Department of Energy, Office of Environmental Restoration and Waste Management. September, 1994. ES/ER/TM-86/R1.

SCDM. 1991. Superfund Chemical Data Matrix. United States Environmental Protection Agency Hazardous Site Evaluation Division. December 1991.

Scarano, Louis, J. Ph.D. and Daniel M. Woltering, Ph.D. January 1993. "Terrestrial and Aquatic Eco-Assessment for A RCRA Hazardous Waste Site". Paper contained in: Application of Ecological Risk Assessment To Hazardous Waste Site Remediation. Cited in WEF, 1993.

Sullivan, J., J. Ball, E. Brick, S. Hausmann, G., G. Pilarski, and D. Sopcich. 1985 Report of the Technical Subcommittee on Determination of Dredge Material Suitability for In-Water Disposal. Wisconsin Department of Natural Resources, Madison, WI. November, 1985.

Suter, G.W. II. and J.B. Mabrey. 1994. Toxicological Benchmarks for Screening Potential Contaminants of Concern for Effects on Aquatic Biota: 1994 Revision. Environmental Sciences Division, Oak Ridge National Laboratory.

Tetra Tech, Inc. 1986. Development of Sediment Quality Values for Puget Sound, Volume I, Puget Sound Dredged Disposal Analysis Report. Cited in Fitchko, 1989.

Travis, Curtis C. and Angela Arms. 1988. Bioconcentration of Organics in Beef, Milk, and Vegetation. Environmental Science Technology. Vol. 22, No. 3.

USEPA, U.S. Environmental Protection Agency. January 26, 1995a. "Toxic Substance Spreadsheet". Region IV, Atlanta, Georgia.

USEPA, U.S. Environmental Protection Agency. January 19, 1995b. "Region III BTAG Screening Levels". Region III, Philadelphia, PA.

USEPA, U.S. Environmental Protection Agency. September 26, 1994a. Ecological Risk Assessment Guidance for Superfund: Process for Designing and Conducting Ecological Risk Assessments. Review Draft Environmental Response Team, Edison NJ

USEPA, U.S. Environmental Protection Agency. June 1994b. Methods for Measuring the Toxicity and Bioaccumulation of Sediment-Associated Contaminants with Freshwater Invertebrates. Office of Research and Development, Washington, DC. EPA/600/R-94/024.

USEPA, U.S. Environmental Protection Agency. September 1993a. Technical Basis for Deriving Sediment Quality Criteria for Nonionic Organic Contaminants for the Protection of Benthic Organisms by using Equilibrium Partitioning. Office of Science and Technology, Health and Ecological Criteria Division. EPA-822-R-93-011.

USEPA, U.S. Environmental Protection Agency. 1993b. "Water Quality Guidance for the Great Lakes System and Correction: Proposed Rules". Federal Register. 58(72) 20802-21047. Cited in Suter and Mabrey, 1994.

USEPA, U.S. Environmental Protection Agency. September 1993c. Sediment Quality Criteria for the Protection of Benthic Organisms: Acenaphthene. Office of Science and Technology, Health and Ecological Criteria Division. EPA-822-R-93-013.

USEPA, U.S. Environmental Protection Agency. September 1993d: Sediment Quality Criteria for the Protection of Benthic Organisms: Fluoranthene. Office of Science and Technology, Health and Ecological Criteria Division. EPA-822-R-93-012.

USEPA, U.S. Environmental Protection Agency. September 1993e. Sediment Quality Criteria for the Protection of Benthic Organisms: Phenanthrene. Office of Science and Technology, Health and Ecological Criteria Division. EPA-822-R-93-014.

USEPA, U.S. Environmental Protection Agency. September 1993f. Sediment Quality Criteria for the Protection of Benthic Organisms: Endrin. Office of Science and Technology, Health and Ecological Criteria Division. EPA-822-R-93-016.

USEPA, U.S. Environmental Protection Agency. October 1, 1993g. Office of Water Policy and Technical Guidance on Interpretation and Implementation of Aquatic Life Metals Criteria. Office of Water.

USEPA, U.S. Environmental Protection Agency. December 1993f. Wildlife Exposure Factors Handbook. Office of Research and Development. Washington, D.C. EPA/600/R-93/187a.

USEPA. U.S. Environmental Protection Agency. February 1992. Framework for Ecological Risk Assessment. United States Environmental Protection Agency. Risk Assessment Forum. EPA/630/R-92/001.

USEPA, U.S. Environmental Protection Agency. June 1991a. National Functional Guidelines for Organic Data Review. Draft. USEPA Contract Laboratory Program.

USEPA, U.S. Environmental Protection Agency. May 1, 1991b. "Water Quality Criteria Summary" (Wall Chart). Office of Science and Technology. Health and Ecological Criteria Section. Washington, D.C.

USEPA, U.S. Environmental Protection Agency. March 1990. Methods for Measuring the Acute Toxicity of Effluents to Freshwater and Marine Organisms. Fourth Edition, Environmental Monitoring Systems Laboratory, Cincinnati, OH. EPA/600/4-90/027F.

USEPA. U.S. Environmental Protection Agency. March 1989a. Risk Assessment Guidance for Superfund Volume II. Environmental Evaluation Manual Interim Final. Office of Solid Waste and Emergency Response. Washington, D.C. EPA/540/1-89-001.

USEPA. U.S. Environmental Protection Agency. March 1989b. Ecological Assessment of Hazardous Waste Sites: A Field and Laboratory Reference. Environmental Research Laboratory, Corvallis, OR. EPA/600/3-89/013.

USEPA. U.S. Environmental Protection Agency. December 1989c. Risk Assessment Guidance for Superfund, Volume I, Human Health Evaluation Manual (Part A). Interim Final EPA/540/1-89/002.

USEPA, U.S. Environmental Protection Agency. 1989d. Short-Term Methods for Estimating the Chronic Toxicity of Effluents and Receiving Waters to Freshwater Organisms. Second Edition, Environmental Monitoring Systems Laboratory, Cincinnati, OH. EPA/600/4-89/001 March 1989.

USEPA. U.S. Environmental Protection Agency. May 1987. Quality Criteria for Water-1986. Office of Water Regulations.

USEPA. U.S. Environmental Protection Agency. October 1986. Chemical, Physical, and Biological Properties of Compounds Present at Hazardous Waste Sites. Office of Solid Waste and Remedial Response. Washington D.C. EPA/540/1-86/060.

Water Environment Federation (WEF). 1989. Application of Ecological Risk Assessment to Hazardous Waste Site Remediation. Based on a January 10, 1993 Workshop., 601 Wythe Street, Alexandria, VA 22314-1994.

Will, M.E. and Suter, G.W. II. 1994a. Toxicological Benchmarks for Screening Potential Contaminants of Concern for Effects on Soil and Litter Invertebrates and Heterotrophic Process. Environmental Sciences Division, Oak Ridge National Laboratory.

Will, M.E. and Suter, G.W. II. 1994b. Toxicological Benchmarks for Screening Potential Contaminants of Concern for Effects on Terrestrial Plants. Environmental Sciences Division, Oak Ridge National Laboratory.

SECTION 7.0 TABLES

TABLE 7-1

**FREQUENCY AND RANGE OF CONTAMINANT DETECTIONS
 COMPARED TO SALTWATER SURFACE WATER SCREENING VALUES
 SITE 43, AGAN STREET DUMP
 REMEDIAL INVESTIGATION CTO-0303
 MCAS, NEW RIVER, NORTH CAROLINA**

Contaminant	Surface Water Screening Values (SWSV)			Average Reference Station Concentration	Contaminant Frequency/Range		No. of Positive Detects Above Lowest SWSV	No. of Positive Detects Above the Average Reference Station Concentration
	North Carolina Water Quality Standards (WQS) ⁽¹⁾	USEPA Region IV Water Quality Screening Values (WQSV) ⁽²⁾			No. of Positive Detects/No. of Samples	Range of Positive Detection		
		Acute	Chronic					
Volatiles (µg/L) 1,2-Dichloroethene (total)	NE	224,000 ⁽³⁾	NE	ND	2/6	2J	0	2
Semivolatiles (µg/L) Bis(2-ethylhexyl)phthlate	NE	NE	360 ⁽³⁾	ND	1/6	200	0	1
Pesticides (µg/L) 4,4'-DDD	0.001 ⁽⁴⁾	0.68 ⁽³⁾	0.001 ⁽⁵⁾	ND	3/6	0.12J-0.64J	3	3
4,4'-DDE	0.001 ⁽⁴⁾	14 ⁽³⁾	0.001 ⁽⁵⁾	ND	2/6	0.095J-0.097J	2	2
Inorganics (µg/L) Aluminum	NE	NE	NE	271	4/6	478-717	NA	4
Arsenic	50	69	36	ND	2/6	1.8J-2.5	0	2
Barium	NE	NE	NE	29	6/6	28.8-36.5	NA	5
Calcium	NE	NE	NE	41,233	6/6	37,200-91,900	NA	5
Copper	3	2.9	2.9	ND	3/6	1.8-3.2	1	3
Iron	NE	NE	NE	582	6/6	675J-4,280J	NA	6
Lead	25	220	8.5	ND	5/6	0.87J-2.8J	0	5
Magnesium	NE	NE	NE	60,933	6/6	8,360-165,000	NA	4
Manganese	NE	NE	10 ⁽³⁾	ND	6/6	38-57.1	6	6
Potassium	NE	NE	NE	22,167	6/6	3,480J-55,200J	NA	4
Sodium	NE	NE	NE	441,333	6/6	67,600-1,370,000	NA	4
Vanadium	NE	NE	10,000 ⁽³⁾	ND	3/6	2.7-3.4	0	3

TABLE 7-1 (Contineud)

**FREQUENCY AND RANGE OF CONTAMINANT DETECTIONS
COMPARED TO SALTWATER SURFACE WATER SCREENING VALUES
SITE 43, AGAN STREET DUMP
REMEDIAL INVESTIGATION CTO-0303
MCAS, NEW RIVER, NORTH CAROLINA**

Notes:

NE = Not Established

NA = Not Applicable

ND = Not Detected

(1) NC DEHNR, 1994 (North Carolina Water Quality Standards)

(2) USEPA, 1995a (Region IV Toxic Substance Spreadsheet)

(3) USEPA, 1995b (Region III BTAG Screening Levels)

(4) Based on 4,4'-DDT

(5) USEPA, 1991b (Wall Chart, based on 4,4'-DDT)

TABLE 7-2

FREQUENCY AND RANGE OF DISSOLVED METALS CONTAMINANT DETECTIONS
 COMPARED TO SALTWATER SURFACE WATER SCREENING VALUES
 SITE 43, AGAN STREET DUMP
 REMEDIAL INVESTIGATION CTO-0303
 MCAS, NEW RIVER, NORTH CAROLINA

Contaminant	Surface Water Screening Values (SWSV)			Contaminant Frequency/Range		No. of Positive Detects Above Lowest SWSV
	North Carolina Water Quality Standards (WQS) ⁽¹⁾	USEPA Region IV Water Quality Screening Values (WQSV) ⁽²⁾		No. of Positive Detects/No. of Samples	Range of Positive Detection	
		Acute	Chronic			
Inorganics (µg/L)						
Barium	NE	NE	NE	6/6	25.3-35.2	NA
Calcium	NE	NE	NE	6/6	36,500-88,900	NA
Copper	3	2.9	2.9	1/6	2.5	0
Iron	NE	NE	NE	2/6	942J-1,330J	NA
Magnesium	NE	NE	NE	6/6	8,610-160,000	NA
Manganese	NE	NE	10 ⁽³⁾	6/6	23.1-53.6	6
Potassium	NE	NE	NE	6/6	3,620J-53,100J	NA
Sodium	NE	NE	NE	6/6	70,200-1,340,000	NA
Vanadium	NE	NE	10,000 ⁽³⁾	2/6	2.2-2.9	0

Notes:

NE = Not Established

NA = Not Applicable

⁽¹⁾ NC DEHNR, 1994 (North Carolina Water Quality Standards)

⁽²⁾ USEPA, 1995a (Region IV Toxic Substance Spreadsheet)

⁽³⁾ USEPA, 1995b (Region III BTAG Screening Levels)

TABLE 7-3

**FREQUENCY AND RANGE OF CONTAMINANT DETECTIONS
 COMPARED TO SALTWATER SEDIMENT SCREENING VALUES
 SITE 43, AGAN STREET DUMP
 REMEDIAL INVESTIGATION CTO-0303
 MCAS, NEW RIVER, NORTH CAROLINA**

Contaminant	Sediment Screening Values (SSV)			Average Reference Station Concentration (midstream)	Contaminant Frequency/Range		No. of Positive Detects Above Lowest SSV	No. of Positive Detect Above the Average Reference Concentration
	ER-L	ER-M	SQC ⁽³⁾		No. of Positive Detects/No. of Samples	Range of Positive Detections		
Volatiles (µg/kg)								
Acetone	NE	NE	NE	ND	3/12	10J-140J	NA	3
Carbon disulfide	NE	NE	NE	ND	3/12	3J-26	NA	3
Semivolatiles (µg/kg)								
Benzo(a)pyrene	430 ⁽¹⁾	1,600 ⁽¹⁾	5,544	ND	4/12	290J-1,900	3	4
Bis(2-ethylhexyl)phthalate	1,900 ⁽⁵⁾	NE	1,632	ND	10/12	280J-2,500	2	10
4-Methylphenol	670 ⁽⁴⁾	NE	NE	ND	1/12	210J	0	1
Pyrene	665 ⁽¹⁾	2,600 ⁽¹⁾	54,720	ND	1/12	200J	0	1
Pesticides (µg/kg)								
4,4'-DDD	2 ⁽²⁾	20 ⁽²⁾	3.7	4.84	11/12	5.6J-37,000	11	11
4,4'-DDE	2.2 ⁽¹⁾	27 ⁽¹⁾	21.12	6.15	10/12	12J-8,900	10	10
4,4'-DDT	1 ⁽²⁾	7 ⁽²⁾	1.17	3.48	6/12	9.3J-180J	6	6
Alpha-chlordane	0.5 ⁽²⁾	6 ⁽²⁾	2.69	ND	8/12	7.2J-49J	8	8
Gamma-chlordane	0.5 ⁽²⁾	6 ⁽²⁾	2.69	ND	9/12	9.6J-74J	9	9
Endrin	0.02 ⁽²⁾	45 ⁽²⁾	0.66	ND	2/12	12J-16J	2	2
Inorganics (mg/kg)								
Aluminum	NE	NE	NE	10,728	12/12	878-16,400	NA	4
Arsenic	8.2 ⁽¹⁾	70 ⁽¹⁾	NE	3.12	6/12	2.1-5.7	0	4
Barium	500 ⁽⁶⁾	NE	NE	15.30	12/12	4.4-46.1	0	8
Beryllium	0.5 ⁽⁵⁾	NE	NE	0.29	1/12	0.1	0	0

TABLE 7-3 (Continued)

FREQUENCY AND RANGE OF CONTAMINANT DETECTIONS
 COMPARED TO SALTWATER SEDIMENT SCREENING VALUES
 SITE 43, AGAN STREET DUMP
 REMEDIAL INVESTIGATION CTO-0303
 MCAS, NEW RIVER, NORTH CAROLINA

Contaminant	Sediment Screening Values (SSV)			Average Reference Station Concentration (midstream)	Contaminant Frequency/Range		No. of Positive Detects Above Lowest SSV	No. of Positive Detect Above the Average Reference Concentration
	ER-L	ER-M	SQC ⁽³⁾		No. of Positive Detects/No. of Samples	Range of Positive Detections		
Cadmium	1.2 ⁽¹⁾	9.6 ⁽¹⁾	NE	0.11	1/12	4.8	1	1
Calcium	NE	NE	NE	3,945	12/12	1,080-13,900	NA	8
Chromium	81 ⁽¹⁾	370 ⁽¹⁾	NE	17.55	12/12	1.8-27.2	0	4
Cobalt	NE	NE	NE	2.18	6/12	0.66-3.1	NA	2
Copper	34 ⁽¹⁾	270 ⁽¹⁾	NE	2.24	9/12	1.7-53	2	8
Iron	27,000 ⁽⁶⁾	NE	NE	13,202	12/12	763-23,800	0	5
Lead	46.7 ⁽¹⁾	218 ⁽¹⁾	NE	10.50	12/12	6.1-206	6	10
Magnesium	NE	NE	NE	2,123	12/12	82.5-6,440	NA	8
Manganese	230 ⁽⁶⁾	NE	NE	33.40	12/12	2.7-78.5	0	6
Mercury	0.15 ⁽¹⁾	0.71 ⁽¹⁾	NE	0.34	2/12	0.44-0.66	2	2
Nickel	20.9 ⁽¹⁾	51.6 ⁽¹⁾	NE	5.58	6/12	1.7-15.5	0	5
Potassium	NE	NE	NE	759	12/12	60.3-1,660	NA	7
Selenium	1.0 ⁽⁶⁾	NE	NE	0.44	5/12	1.5J-2.6	5	5
Silver	1.0 ⁽¹⁾	3.7 ⁽¹⁾	NE	ND	2/12	1.9-2.8	2	2
Sodium	NE	NE	NE	2,190	12/12	52.7-14,800	NA	8
Vanadium	NE	NE	NE	17.57	12/12	2.1-63.9	NA	7
Zinc	150 ⁽¹⁾	410 ⁽¹⁾	NE	27.38	12/12	1.5-338	4	10

TABLE 7-3 (Continued)

FREQUENCY AND RANGE OF CONTAMINANT DETECTIONS
COMPARED TO SALTWATER SEDIMENT SCREENING VALUES
SITE 43, AGAN STREET DUMP
REMEDIAL INVESTIGATION CTO-0303
MCAS, NEW RIVER, NORTH CAROLINA

Notes:

NE = Not Established
NA = Not Applicable
ER-L = Effects Range Low
ER-M = Effects Range Median
SQC = Sediment Quality Criteria

(1) Long *et al.*, 1995

(2) Long and Morgan, 1991

(3) Values were calculated using the following equation: $SQC = Foc * Koc * FCV / 1000000$

Where:

Foc = Fraction of organic carbon in the sediments (used 4,800 mg/kg)

Koc = Organic carbon partition coefficient (chemical specific)

FCV = Final water chronic value (chemical specific)

(4) USEPA, 1995a (Region III BTAG Screening Levels)

(5) Tetra Tech Inc., 1986 (Apparent Effects Threshold Sediment Quality Values)

(6) Sullivan *et al.*, 1985

TABLE 7-4

**CONTAMINANTS OF POTENTIAL CONCERN IN EACH MEDIA
SITE 43, AGAN STREET DUMP
REMEDIAL INVESTIGATION CTO-0303
MCAS, NEW RIVER, NORTH CAROLINA**

Contaminant	Surface Water		Sediment	Surface Soil
	Aquatic receptors	Terrestrial receptors		
Volatiles				
Acetone			X	
Carbon disulfide			X	
1,2-Dichloroethene		X		
Semivolatiles				
Acenaphthene				X
Anthracene				X
Benzo(a)anthracene				X
Benzo(b)fluoranthene				X
Benzo(k)fluoranthene				X
Benzo(g,h,i)perylene				X
Benzo(a)pyrene			X	X
Bis(2-ethylhexyl)phthalate			X	X
Butylbenzylphthalate				X
Carbazole				X
Chrysene				X
Dibenzo(a,h)anthracene				X
Dibenzofuran				X
Fluoranthene				X
Fluorene				X
Indeno(1,2,3-cd)pyrene				X
Phenanthrene				X
Pyrene				X
Pesticides/PCBs				
Alpha-chlordane			X	
Gamma-chlordane			X	
4,4'-DDE	X	X	X	X
4,4'-DDD	X	X	X	X
4,4'-DDT			X	X
Endrin			X	
Endrin aldehyde				X
Heptachlor epoxide				X

TABLE 7-4 (Continued)

CONTAMINANTS OF POTENTIAL CONCERN IN EACH MEDIA
 SITE 43, AGAN STREET DUMP
 REMEDIAL INVESTIGATION CTO-0303
 MCAS, NEW RIVER, NORTH CAROLINA

Contaminant	Surface Water		Sediment	Surface Soil
	Aquatic receptors	Terrestrial receptors		
Inorganics				
Aluminum	X	X	X	X
Arsenic		X		
Barium	X	X		X
Cadmium			X	X
Chromium				X
Cobalt			X	X
Copper	X	X	X	X
Iron	X	X		X
Lead		X	X	X
Manganese	X	X		X
Mercury			X	X
Nickel				X
Selenium			X	
Silver			X	
Vanadium		X	X	X
Zinc			X	X

TABLE 7-5

**PHYSICAL/CHEMICAL CHARACTERISTICS OF THE COPCS
SITE 43, AGAN STREET DUMP
REMEDIAL INVESTIGATION CTO-0303
MCAS, NEW RIVER, NORTH CAROLINA**

Contaminant of Potential Concern	BCF	Organic Carbon Partition Coefficient (mL/g)	Log Octanol/Water Coefficient	Biotransfer Factors		
				Bv ⁽¹⁾⁽²⁾	Br ⁽¹⁾⁽²⁾	Bb ⁽¹⁾⁽²⁾
Volatiles						
Acetone	0.69 ⁽⁴⁾	2.2 ⁽⁵⁾	-0.24 ⁽⁶⁾	5.30e+01	5.30e+01	1.45e-08
Carbon disulfide	ND	54 ⁽⁵⁾	0 ⁽⁶⁾	3.90e+01	3.90e+01	2.51e-08
1,2-Dichloroethene	5.6 ⁽³⁾	54 ⁽⁵⁾	2 ⁽⁶⁾	2.70e+00	2.70e+00	2.51e-06
Semivolatiles						
Acenaphthene	242 ⁽³⁾	5,754 ⁽⁹⁾	3.8 ⁽⁹⁾	2.46e-01	2.46e-01	1.58e-04
Anthracene	30 ⁽³⁾	14,000 ⁽⁵⁾	4.5 ⁽⁶⁾	9.70e-02	9.70e-02	7.94e-04
Benzo(a)anthracene	30 ⁽³⁾	1,380,000 ⁽⁵⁾	5.7 ⁽⁶⁾	2.00e-02	2.00e-02	1.26e-02
Benzo(a)pyrene	30 ⁽³⁾	5,500,000 ⁽⁵⁾	6.0 ⁽⁶⁾	1.30e-02	1.30e-02	2.51e-02
Benzo(b)fluoranthene	30 ⁽³⁾	550,000 ⁽⁵⁾	6.6 ⁽⁶⁾	6.00e-03	6.00e-03	1.00e-01
Benzo(k)fluoranthene	30 ⁽³⁾	550000	6.1 ⁽⁵⁾	1.20e-02	1.20e-02	3.16e-02
Benzo(g,h,i)perylene	30 ⁽³⁾	1,600,000 ⁽⁵⁾	6.5 ⁽⁵⁾	7.00e-03	7.00e-03	7.94e-02
Bis(2-ethylhexyl)phthalate	130 ⁽³⁾	100,000 ⁽⁷⁾	5.1 ⁽⁶⁾	4.40e-02	4.40e-02	3.16e-03
Butylbenzylphthalate	414 ⁽³⁾	ND	4.9 ⁽⁶⁾	5.70e-02	5.70e-02	2.00e-03
Carbazole	ND	ND	6 ⁽⁸⁾	1.30e-02	1.30e-02	2.51e-02
Chrysene	30 ⁽³⁾	200,000 ⁽⁵⁾	5.7 ⁽⁶⁾	2.00e-02	2.00e-02	1.26e-02
Dibenz(a,h)anthracene	30 ⁽³⁾	3,300,000 ⁽⁵⁾	6.5 ⁽⁶⁾	7.00e-03	7.00e-03	7.94e-02
Dibenzofuran	ND	ND	6 ⁽⁸⁾	1.30e-02	1.30e-02	2.51e-02
Fluoranthene	1,150 ⁽³⁾	100,000 ⁽¹⁰⁾	5.1 ⁽¹⁰⁾	4.40e-02	4.40e-02	3.90e-03
Fluorene	30 ⁽³⁾	7,300 ⁽⁵⁾	4.2 ⁽⁶⁾	1.45e-01	1.45e-01	3.98e-04
Indeno(1,2,3-cd)pyrene	30 ⁽³⁾	1,600,000 ⁽⁵⁾	6.5 ⁽⁵⁾	7.00e-03	7.00e-03	8.13e-02
Phenanthrene	30 ⁽³⁾	28,840 ⁽¹¹⁾	4.5 ⁽¹¹⁾	9.70e-02	9.70e-02	7.94e-04
Pyrene	30 ⁽³⁾	38,000 ⁽⁵⁾	5.3 ⁽⁶⁾	3.30e-02	3.30e-02	5.01e-03
Pesticides						
Alpha-chlordane	14,100 ⁽³⁾	140,000 ⁽⁵⁾	5.5 ⁽⁶⁾	2.60e-02	2.60e-02	7.94e-03
Gamma-chlordane	14,100 ⁽³⁾	140,000 ⁽⁵⁾	5.5 ⁽⁶⁾	2.60e-02	2.60e-02	7.94e-03
4,4'-DDD	53,600 ⁽³⁾	770,000 ⁽⁵⁾	6 ⁽⁶⁾	1.32e-02	1.32e-02	2.51e-02
4,4'-DDE	53,600 ⁽³⁾	4,400,000 ⁽⁵⁾	5.7 ⁽⁶⁾	2.00e-02	2.00e-02	1.26e-02
4,4'-DDT	53,600 ⁽³⁾	243,000 ⁽⁵⁾	6.4 ⁽⁶⁾	8.00e-03	8.00e-03	6.31e-02
Endrin	3,970 ⁽³⁾	69,183 ⁽¹²⁾	4.9 ⁽¹²⁾	5.50e-01	5.50e-01	2.09e-03
Endrin aldehyde	3,970 ⁽¹³⁾	69,183 ⁽¹³⁾	4.9 ⁽¹³⁾	5.50e-01	5.50e-01	2.09e-03
Heptachlor epoxide	11,200 ⁽³⁾	220 ⁽⁵⁾	4.3 ⁽⁶⁾	1.27e-01	1.27e-01	5.01e-04

TABLE 7-5 (Continued)

PHYSICAL/CHEMICAL CHARACTERISTICS OF THE COPCS
 SITE 43, AGAN STREET DUMP
 REMEDIAL INVESTIGATION CTO-0303
 MCAS, NEW RIVER, NORTH CAROLINA

Contaminant of Potential Concern	BCF	Organic Carbon Partition Coefficient (mL/g)	Log Octanol/Water Coefficient	Biotransfer Factors		
				Bv ⁽¹⁾⁽²⁾	Br ⁽¹⁾⁽²⁾	Bb ⁽¹⁾⁽²⁾
Inorganics						
Aluminum	231 ⁽⁴⁾	ND	ND	4.00e-03	6.50e-04	1.50e-03
Arsenic	44 ⁽³⁾	ND	ND	4.00e-02	6.00e-03	2.00e-03
Barium	8 ⁽⁴⁾	ND	ND	1.50e-01	1.50e-02	1.50e-04
Cadmium	64 ⁽³⁾	ND	ND	5.50e-01	1.50e-01	5.50e-04
Chromium	16 ⁽³⁾	ND	ND	7.50e-03	4.50e-03	5.50e-03
Cobalt	40 ⁽⁴⁾	ND	ND	2.00e-02	7.00e-03	2.00e-02
Copper	36 ⁽³⁾	ND	ND	4.00e-01	2.50e-01	1.00e-02
Iron	ND	ND	ND	4.00e-03	1.00e-03	2.00e-02
Lead	49 ⁽³⁾	ND	ND	4.50e-02	9.00e-03	3.00e-04
Manganese	35 ⁽⁴⁾	ND	ND	2.50e-01	5.00e-02	4.00e-04
Mercury	5,500 ⁽³⁾	ND	ND	9.00e-01	2.00e-01	2.50e-01
Nickel	47 ⁽³⁾	ND	ND	6.00e-02	6.00e-02	6.00e-03
Selenium	6 ⁽³⁾	ND	ND	2.50e-02	2.50e-02	1.50e-02
Silver	0.5 ⁽³⁾	ND	ND	4.00e-01	1.00e-01	3.00e-03
Vanadium	ND	ND	ND	5.50e-03	3.00e-03	2.50e-03
Zinc	47 ⁽³⁾	ND	ND	1.50e+00	9.00e-01	1.00e-01

Notes:

- (1) Baes, 1984 for the inorganics
- (2) The organics were calculated using Travis, 1988
- (3) USEPA, 1995a (Region IV)
- (4) USEPA, 1995b (Region III)
- (5) USEPA, 1986
- (6) SCDM, 1991
- (7) Montgomery and Welton, 1990
- (8) Used benzo(a)pyrene Kow
- (9) USEPA, 1993c (Sediment Quality Criteria for Acenaphthene)
- (10) USEPA, 1993d (Sediment Quality Criteria for Fluoranthene)
- (11) USEPA, 1993e (Sediment Quality Criteria for Phenanthrene)
- (12) USEPA, 1993f (Sediment Quality Criteria for Endrin)
- (13) Used Endrin Value

BCF = Bioconcentration Factor

ND = No Data

Bv = Biotransfer factor for vegetation (stems, leaves)

Br = Biotransfer factor for vegetation (berries, fruits)

Bb = Biotransfer factor for beef

TABLE 7-6

**SAMPLING STATION CHARACTERIZATION SUMMARY
SITE 43, AGAN STREET DUMP
REMEDIAL INVESTIGATION CTO-0303
MCAS, NEW RIVER, NORTH CAROLINA**

Station	Stream Width (ft)	Stream Depth (ft)	Canopy Cover	Sediment Description	Sediment Odor
43-SHC-SW/SD01	5	0.5	Partly Open	Medium to fine sand (gray/black)	Normal
43-SHC-SW/SD02	10	1	Shaded	Medium to fine sand (gray/black)	Normal
43-SHC-SW/SD03	20	0.5	Partly Shaded	Silty muck with organic material (brown)	Strong Anaerobic
43-SHC-SW/SD04	15	0.5-1	Partly Open	Silty muck with organic material (brown)	Strong Anaerobic
43-EC-SW/SD01	50	NM	Open	Silty muck with organic material (brown)	Strong Anaerobic
43-EC-SW/SD02	35	NM	Open	Silty muck with organic material (brown)	Anaerobic

Notes:

- NM = Not Measured (Creek bed was too soft to walk)
- SW = Surface Water Sample
- SD = Sediment Sample
- EC = Edwards Creek
- SHC = Strawhorn Creek

TABLE 7-7

FIELD CHEMISTRY DATA
 SITE 43, AGAN STREET DUMP
 REMEDIAL INVESTIGATION CTO-0303
 MCAS, NEW RIVER, NORTH CAROLINA

Station	Temperature (°C)	pH (S.U.)	Dissolved Oxygen (mg/L)	Conductivity (umhos/cm)	Salinity (ppt)
43-SHC-SW/SD01	20.1	6.53	3.6	788	0.3
43-SHC-SW/SD02	18.3	6.71	3.7	5,750	3
43-SHC-SW/SD03	18.5-19.5	6.78-6.96	4.2-4.9	6,220-6,610	4-4.8
43-SHC-SW/SD04	20.0-20.3	6.85-7.82	4.6-7.7	10,100-10,600	5.8-7.0
43-EC-SW/SD01	19.9-22	8.19	9.9	8,100-9,600	4.6-5.4
43-EC-SW/SD02	21.3-22	8.67	13.7	7,500-9,900	4.8-5.0

Notes:

- °C = Degrees Centigrade
- mg/L = Milligrams per Liter
- S.U. = Standard Units
- umhos/cm = Micromhos per centimeter
- ppt = Parts Per Thousand
- EC = Edwards Creek
- SHC = Strawhorn Creek
- SW = Surface Water Sample
- SD = Sediment Sample

TABLE 7-8

**FREQUENCY AND RANGE OF CONTAMINANT DETECTIONS
 COMPARED TO SOIL FLORA AND FAUNA SCREENING VALUES
 SITE 43, AGAN STREET DUMP
 REMEDIAL INVESTIGATION CTO-0303
 MCAS, NEW RIVER, NORTH CAROLINA**

Contaminant	Soil Flora and Fauna Screening Values ⁽¹⁾				Contaminant Frequency/Range		No. of Positive Detects Above Lowest Screening Value
	Plant	Earthworm	Invertebrate	Microorganisms and Microbial Processes	No. of Positive Detects/No. of Samples	Range of Positive Detections	
Semivolatiles (µg/kg)							
Acenaphthene	NE	100 ⁽²⁾	100 ⁽²⁾	NE	3/28	45J-2,900	1
Anthracene	NE	100 ⁽²⁾	100 ⁽²⁾	NE	3/28	44J-820	2
Benzo(a)anthracene	NE	100 ⁽²⁾	100 ⁽²⁾	NE	9/28	51J-41,000	7
Benzo(b)fluoranthene	NE	100 ⁽²⁾	100 ⁽²⁾	NE	10/28	44J-52,000	9
Benzo(k)fluoranthene	NE	100 ⁽²⁾	100 ⁽²⁾	NE	9/28	57J-20,000	8
Benzo(g,h,i)perylene	NE	100 ⁽²⁾	100 ⁽²⁾	NE	9/28	87J-24,000	8
Benzo(a)pyrene	NE	20,000 ⁽²⁾	25,000	NE	9/28	79J-39,000	1
Bis(2-ethylhexyl)phthalate	NE	NE	NE	NE	10/28	43J-430J	NA
Butylbenzylphthalate	NE	NE	NE	NE	3/28	50J-420J	NA
Carbazole	NE	NE	NE	NE	5/28	99J-350J	NA
Chrysene	NE	100 ⁽²⁾	100 ⁽²⁾	NE	9/28	110J-46,000	9
Dibenzo(a,h)anthracene	NE	100 ⁽²⁾	100 ⁽²⁾	NE	8/28	47J-1,200	6
Dibenzofuran	NE	NE	NE	NE	2/28	35J-870	NA
Fluoranthene	NE	100 ⁽²⁾	100 ⁽²⁾	NE	10/28	49J-60,000	9
Fluorene	NE	30,000	100 ⁽²⁾	NE	3/28	53J-1,700	1
Indeno(1,2,3-cd)pyrene	NE	100 ⁽²⁾	100 ⁽²⁾	NE	10/28	42J-27,000	8
Phenanthrene	NE	100 ⁽²⁾	100 ⁽²⁾	NE	8/28	54J-5,900J	6
Pyrene	NE	100 ⁽²⁾	100 ⁽²⁾	NE	10/28	49J-64,000	9

TABLE 7-8 (Continued)

FREQUENCY AND RANGE OF CONTAMINANT DETECTIONS
 COMPARED TO SOIL FLORA AND FAUNA SCREENING VALUES
 SITE 43, AGAN STREET DUMP
 REMEDIAL INVESTIGATION CTO-0303
 MCAS, NEW RIVER, NORTH CAROLINA

Contaminant	Soil Flora and Fauna Screening Values ⁽¹⁾				Contaminant Frequency/Range		No. of Positive Detects Above Lowest Screening Value
	Plant	Earthworm	Invertebrate	Microorganisms and Microbial Processes	No. of Positive Detects/No. of Samples	Range of Positive Detections	
Pesticides (µg/kg)							
4,4'-DDD	NE	100 ⁽²⁾	100 ⁽²⁾	NE	1/7	3,000	1
4,4'-DDE	NE	100 ⁽²⁾	100 ⁽²⁾	NE	5/7	5.7J-1,000J	1
4,4'-DDT	NE	4 ⁽²⁾	4 ⁽²⁾	NE	4/7	10-1,000J	4
Endrin aldehyde	NE	<100 ⁽²⁾	<100 ⁽²⁾	NE	1/7	5.4J	0
Heptachlor epoxide	NE	<100 ⁽²⁾	<100 ⁽²⁾	NE	1/7	2J	0
Inorganics (mg/kg)							
Aluminum	50	NE	NE	600	21/21	1,060J-8,890	21
Barium	500	440 ⁽²⁾	440 ⁽²⁾	3,000	21/21	3.2-551	1
Cadmium	3	20	3	20	2/21	0.74-1.7	0
Chromium	1	0.4	0.0075 ⁽²⁾	10	21/21	1.1-106	21
Cobalt	20	1,500 ⁽²⁾	1,500 ⁽²⁾	1,000	5/21	0.78-4.1	0
Copper	100	50	20	100	17/21	0.47-55.7	2
Iron	100 ⁽²⁾	NE	3,515	200	21/21	844-21,100	21
Lead	50	500	300	900	20/21	4.3-246	3
Manganese	500	330 ⁽²⁾	330 ⁽²⁾	100	21/21	2.8-189	1
Mercury	0.3	0.1	300	30	3/21	0.12-0.51	3
Nickel	30	200	NE	90	8/21	1.1-5	0
Vanadium	2	58 ⁽²⁾	58 ⁽²⁾	20	21/21	3.1-17.3	21
Zinc	50	200	500	100	21/21	1.5-595	3

TABLE 7-8 (Continued)

**FREQUENCY AND RANGE OF CONTAMINANT DETECTIONS
COMPARED TO SOIL FLORA AND FAUNA SCREENING VALUES
SITE 43, AGAN STREET DUMP
REMEDIAL INVESTIGATION CTO-0303
MCAS, NEW RIVER, NORTH CAROLINA**

Notes:

- (1) Will and Suter, 1994a and 1994b unless indicated otherwise (Values presented for plants, earthworms, and microorganisms and microbial processes are benchmarks below which adverse impacts to these species are not expected. Values for invertebrates are No Observed Effects Concentrations, however, they are based on less data than the benchmarks)
- (2) USEPA, 1995 (Region III BTAG Soil Screening Values for Soil Fauna)

TABLE 7-9

EXPOSURE PARAMETERS FOR CHRONIC DAILY INTAKE MODEL
 SITE 43, AGAN STREET DUMP
 REMEDIAL INVESTIGATION CTO-0303
 MCAS, NEW RIVER, NORTH CAROLINA

Exposure Parameter	Units	White-Tailed Deer	Eastern Cottontail Rabbit	Bobwhite Quail	Red Fox	Raccoon	Small Mammal (Meadow Vole)
Food Source Ingestion	NA	Vegetation 100%	Vegetation 100%	Vegetation 100%	Small Mammals 80% Vegetation 20%	Vegetation 40% Fish 60%	Vegetation 100%
Feeding Rate	kg/day	1.6 ⁽²⁾	0.237 ⁽⁴⁾	0.0135 ⁽³⁾	0.601 ⁽³⁾	0.214 ⁽⁶⁾	0.112 ⁽³⁾
Incident Soil Ingestion	kg/day	0.0185 ⁽¹⁾	0.0057 ⁽⁵⁾	0.0011 ⁽⁵⁾	0.0168 ⁽⁵⁾	0.0201 ⁽⁵⁾	0.00269 ⁽⁵⁾
Rate of Drinking Water Ingestion	L/day	1.1 ⁽²⁾	0.119 ⁽³⁾	0.0191 ⁽³⁾	0.385 ⁽³⁾	0.422 ⁽³⁾	0.0652 ⁽³⁾
Rate of Vegetation Ingestion	kg/day	1.6	0.237	0.0135	0.12	0.086	0.112
Body Weight	kg	45.4 ⁽²⁾	1.229 ⁽³⁾	0.174 ⁽³⁾	4.54 ⁽³⁾	5.12 ⁽³⁾	0.3725 ⁽³⁾
Rate of Small Mammal Ingestion	kg/day	NA	NA	NA	0.48	NA	NA
Rate of Fish Ingestion	kg/day	NA	NA	NA	NA	0.128	NA
Home Range Size	acres	454 ⁽²⁾	9.30 ⁽³⁾	26.24 ⁽³⁾	1,245 ⁽³⁾	257 ⁽³⁾	0.032 ⁽³⁾

Notes:

NA = Not Applicable

⁽¹⁾ Arthur and Alldridge, 1979

⁽²⁾ Dee, 1991

⁽³⁾ USEPA, 1993g

⁽⁴⁾ Opresko, et.al., 1994

⁽⁵⁾ Beyer, 1993

⁽⁶⁾ Nagy, 1987

TABLE 7-10

SURFACE WATER QUOTIENT INDEX
 SITE 43, AGAN STREET DUMP
 REMEDIAL INVESTIGATION CTO-0303
 MCAS, NEW RIVER, NORTH CAROLINA

Contaminant	Station	Concentration (µg/L)	Quotient Index		
			North Carolina WQS	USEPA SWSV	
				Acute	Chronic
Pesticides					
4,4'-DDD	43-EC-SW01	1J	640	0.9	640
	43-SHC-SW03	0.23	230	0.3	230
	43-SHC-SW04	0.0000J	120	0.2	120
4,4'-DDE	43-EC-SW01	0.0000J	97	0.0	97
	43-SHC-SW03	0.0000J	95	0.0	95
Total Inorganics					
Copper	43-EC-SW02	3.2	1.1	1.1	1.1
Manganese	43-EC-SW01	48.9	NA	NA	4.9
	43-EC-SW02	51.5	NA	NA	5.2
	43-SHC-SW01	38	NA	NA	3.8
	43-SHC-SW02	51.9	NA	NA	5.2
	43-SHC-SW03	57.1	NA	NA	5.7
	43-SHC-SW04	38.7	NA	NA	3.9
Dissolved Inorganics					
Manganese	43-EC-DSW01	27.3	NA	NA	2.7
	43-EC-DSW02	23.1	NA	NA	2.3
	43-SHC-DSW01	36.9	NA	NA	3.7
	43-SHC-DSW02	53.6	NA	NA	5.4
	43-SHC-DSW03	48.3	NA	NA	4.8
	43-SHC-DSW04	27.4	NA	NA	2.7

Notes:

Shaded Samples are Quotient Indices That Exceed "1"

NE = Not Established

WQS = Water Quality Standard

SWSV = Surface Water Screening Value

TABLE 7-11

FREQUENCY AND RANGE OF CONTAMINANT DETECTIONS
 COMPARED TO SALTWATER SEDIMENT SCREENING VALUES
 SITE 43, AGAN STREET DUMP
 REMEDIAL INVESTIGATION CTO-0303
 MCAS, NEW RIVER, NORTH CAROLINA

Contaminant	Sediment Screening Values (SSV)			Average Reference Station Concentration (midstream)	Contaminant Frequency/Range		No. of Positive Detects Above Lowest SSV	No. of Positive Detect Above the Average Reference Concentration
	ER-L	ER-M	SQC ⁽³⁾		No. of Positive Detects/No. of Samples	Range of Positive Detections		
Volatiles (µg/kg)								
Acetone	NE	NE	NE	ND	3/12	10J-140J	NA	3
Carbon disulfide	NE	NE	NE	ND	3/12	3J-26	NA	3
Semivolatiles (µg/kg)								
Benzo(a)pyrene	430 ⁽¹⁾	1,600 ⁽¹⁾	5,544	ND	4/12	290J-1,900	3	4
Bis(2-ethylhexyl)phthalate	1,900 ⁽⁵⁾	NE	1,632	ND	10/12	280J-2,500	2	10
4-Methylphenol	670 ⁽⁴⁾	NE	NE	ND	1/12	210J	0	1
Pyrene	665 ⁽¹⁾	2,600 ⁽¹⁾	54,720	ND	1/12	200J	0	1
Pesticides (µg/kg)								
4,4'-DDD	2 ⁽²⁾	20 ⁽²⁾	3.7	4.84	11/12	5.6J-37,000	11	11
4,4'-DDE	2.2 ⁽¹⁾	27 ⁽¹⁾	21.12	6.15	10/12	12J-8,900	10	10
4,4'-DDT	1 ⁽²⁾	7 ⁽²⁾	1.17	3.48	6/12	9.3J-180J	6	6
Alpha-chlordane	0.5 ⁽²⁾	6 ⁽²⁾	2.69	ND	8/12	7.2J-49J	8	8
Gamma-chlordane	0.5 ⁽²⁾	6 ⁽²⁾	2.69	ND	9/12	9.6J-74J	9	9
Endrin	0.02 ⁽²⁾	45 ⁽²⁾	0.66	ND	2/12	12J-16J	2	2
Inorganics (mg/kg)								
Aluminum	NE	NE	NE	10,728	12/12	878-16,400	NA	4
Arsenic	8.2 ⁽¹⁾	70 ⁽¹⁾	NE	3.12	6/12	2.1-5.7	0	4
Barium	500 ⁽⁶⁾	NE	NE	15.30	12/12	4.4-46.1	0	8
Beryllium	0.5 ⁽⁵⁾	NE	NE	0.29	1/12	0.1	0	0

TABLE 7-11 (Continued)

FREQUENCY AND RANGE OF CONTAMINANT DETECTIONS
 COMPARED TO SALTWATER SEDIMENT SCREENING VALUES
 SITE 43, AGAN STREET DUMP
 REMEDIAL INVESTIGATION CTO-0303
 MCAS, NEW RIVER, NORTH CAROLINA

Contaminant	Sediment Screening Values (SSV)			Average Reference Station Concentration (midstream)	Contaminant Frequency/Range		No. of Positive Detects Above Lowest SSV	No. of Positive Detect Above the Average Reference Concentration
	ER-L	ER-M	SQC ⁽³⁾		No. of Positive Detects/No. of Samples	Range of Positive Detects		
Cadmium	1.2 ⁽¹⁾	9.6 ⁽¹⁾	NE	0.11	1/12	4.8	1	1
Calcium	NE	NE	NE	3,945	12/12	1,080-13,900	NA	8
Chromium	81 ⁽¹⁾	370 ⁽¹⁾	NE	17.55	12/12	1.8-27.2	0	4
Cobalt	NE	NE	NE	2.18	6/12	0.66-3.1	NA	2
Copper	34 ⁽¹⁾	270 ⁽¹⁾	NE	2.24	9/12	1.7-53	2	8
Iron	27,000 ⁽⁵⁾	NE	NE	13,202	12/12	763-23,800	0	5
Lead	46.7 ⁽¹⁾	218 ⁽¹⁾	NE	10.50	12/12	6.1-206	6	10
Magnesium	NE	NE	NE	2,123	12/12	82.5-6,440	NA	8
Manganese	230 ⁽⁵⁾	NE	NE	33.40	12/12	2.7-78.5	0	6
Mercury	0.15 ⁽¹⁾	0.71 ⁽¹⁾	NE	0.34	2/12	0.44-0.66	2	2
Nickel	20.9 ⁽¹⁾	51.6 ⁽¹⁾	NE	5.58	6/12	1.7-15.5	0	5
Potassium	NE	NE	NE	759	12/12	60.3-1,660	NA	7
Selenium	1.0 ⁽⁵⁾	NE	NE	0.44	5/12	1.5J-2.6	5	5
Silver	1.0 ⁽¹⁾	3.7 ⁽¹⁾	NE	ND	2/12	1.9-2.8	2	2
Sodium	NE	NE	NE	2,190	12/12	52.7-14,800	NA	8
Vanadium	NE	NE	NE	17.57	12/12	2.1-63.9	NA	7
Zinc	150 ⁽¹⁾	410 ⁽¹⁾	NE	27.38	12/12	1.5-338	4	10

TABLE 7-11 (Continued)

FREQUENCY AND RANGE OF CONTAMINANT DETECTIONS
COMPARED TO SALTWATER SEDIMENT SCREENING VALUES
SITE 43, AGAN STREET DUMP
REMEDIAL INVESTIGATION CTO-0303
MCAS, NEW RIVER, NORTH CAROLINA

Notes:

NE = Not Established

NA = Not Applicable

ER-L = Effects Range Low

ER-M = Effects Range Median

SQC = Sediment Quality Criteria

(1) Long *et al.*, 1995

(2) Long and Morgan, 1991

(3) Values were calculated using the following equation: $SQC = Foc * Koc * FCV / 1000000$

Where:

Foc = Fraction of organic carbon in the sediments (used 4,800 mg/kg)

Koc = Organic carbon partition coefficient (chemical specific)

FCV = Final water chronic value (chemical specific)

(4) USEPA, 1995a (Region III BTAG Screening Levels)

(5) Tetra Tech Inc., 1986 (Apparent Effects Threshold Sediment Quality Values)

(6) Sullivan *et al.*, 1985

TABLE 7-12

TERRESTRIAL INTAKE MODEL QUOTIENT INDICES
 SITE 43, AGAN STREET DUMP
 REMEDIAL INVESTIGATION, CTO-0303
 MCAS, NEW RIVER, NORTH CAROLINA

Contaminant of Potential Concern	Red Fox	Bobwhite Quail	Cottontail Rabbit	Raccoon	Whitetail Deer
1,2-Dichloroethene (total)	7.99e-05	1.62e-05	5.90e-05	2.18e-04	4.91e-05
Acenaphthene	5.17e-06	9.57e-05	1.54e-03	2.05e-05	2.71e-05
Anthracene	9.95e-07	1.64e-05	2.17e-04	4.44e-06	3.58e-06
Benzo(a)anthracene	3.09e-04	4.28e-03	3.59e-02	1.57e-03	4.74e-04
Benzo(b)fluoranthene	5.33e-04	6.83e-03	4.55e-02	2.74e-03	4.90e-04
Benzo(k)fluoranthene	1.83e-04	2.44e-03	1.81e-02	9.40e-04	2.17e-04
Benzo(g,h,i)perylene	2.50e-04	3.24e-03	2.20e-02	1.29e-03	2.41e-04
Benzo(a)pyrene	3.49e-04	4.69e-03	3.59e-02	1.79e-03	4.40e-04
Bis(2-ethylhexyl)phthalate	1.62e-01	1.01e-02	1.39e-01	6.62e+00	9.95e-02
Butylbenzylphthalate	2.07e-06	3.18e-05	3.63e-04	9.78e-06	5.67e-06
Carbazole	2.64e-04	5.14e-03	9.13e-02	9.33e-04	1.65e-03
Chrysene	3.74e-04	5.17e-03	4.35e-02	1.90e-03	5.73e-04
Dibenz(a,h)anthracene	7.31e-05	9.45e-04	6.41e-03	3.77e-04	7.04e-05
Dibenzofuran	3.04e-04	5.92e-03	1.05e-01	1.08e-03	1.90e-03
Fluoranthene	5.31e-05	7.92e-04	8.38e-03	2.56e-04	1.26e-04
Fluorene	4.74e-06	8.23e-05	1.20e-03	2.02e-05	2.05e-05
Indeno(1,2,3-cd)pyrene	2.92e-04	3.76e-03	2.55e-02	1.50e-03	2.79e-04
Phenanthrene	2.44e-06	4.02e-05	5.32e-04	1.09e-05	8.80e-06
Pyrene	8.07e-05	1.17e-03	1.14e-02	3.97e-04	1.64e-04
4,4'-DDD	5.57e-04	1.33e-01	4.10e-02	2.64e+00	5.99e-04
4,4'-DDE	1.62e-04	4.72e-02	1.60e-02	4.00e-01	2.26e-04
4,4'-DDT	1.29e-04	4.15e-02	1.16e-02	6.65e-04	1.30e-04
Endrin aldehyde	6.58e-06	1.81e-05	3.49e-04	9.52e-06	5.42e-06
Heptachlor epoxide	7.68e-04	1.31e-02	1.85e-01	3.32e-03	3.13e-03
Aluminum	1.28e-02	5.17e-01	2.09e+00	1.48e+01	1.41e-02
Arsenic	9.93e-03	1.89e-04	3.06e-03	1.28e-01	2.92e-04
Barium	6.53e-02	1.42e-01	1.32e+00	2.01e-01	6.70e-02
Cadmium	1.03e-03	2.30e-03	1.91e+00	1.05e-01	9.21e-02
Chromium	1.00e-03	5.68e-04	2.50e-03	5.19e-03	7.46e-05
Cobalt	1.47e-04	3.18e-03	1.71e-02	7.03e-04	6.06e-04
Copper	3.59e-04	6.80e-03	1.12e-01	1.34e-03	1.08e-02
Iron	2.92e-02	1.03e-01	8.23e-01	7.05e-02	2.70e-02
Lead	1.15e-03	4.67e-02	5.19e-01	5.65e-03	2.13e-02
Manganese	2.38e-03	1.63e-03	8.32e-02	1.75e-02	8.86e-03
Mercury	3.11e-04	1.44e-02	1.63e-01	3.28e-04	8.23e-03

TABLE 7-12 (Continued)

TERRESTRIAL INTAKE MODEL QUOTIENT INDICES
 SITE 43, AGAN STREET DUMP
 REMEDIAL INVESTIGATION, CTO-0303
 MCAS, NEW RIVER, NORTH CAROLINA

Contaminant of Potential Concern	Red Fox	Bobwhite Quail	Cottontail Rabbit	Raccoon	Whitetail Deer
Nickel	3.99e-06	2.79e-04	1.23e-02	2.85e-04	5.19e-04
Vanadium	2.45e-03	7.51e-04	9.02e-01	8.38e-03	7.64e-04
Zinc	1.16e-01	1.19e-01	2.87e+00	4.40e-03	1.40e-01
Total Quotient Index	4.08e-01	1.25e+00	1.17e+01	2.51e+01	5.03e-01

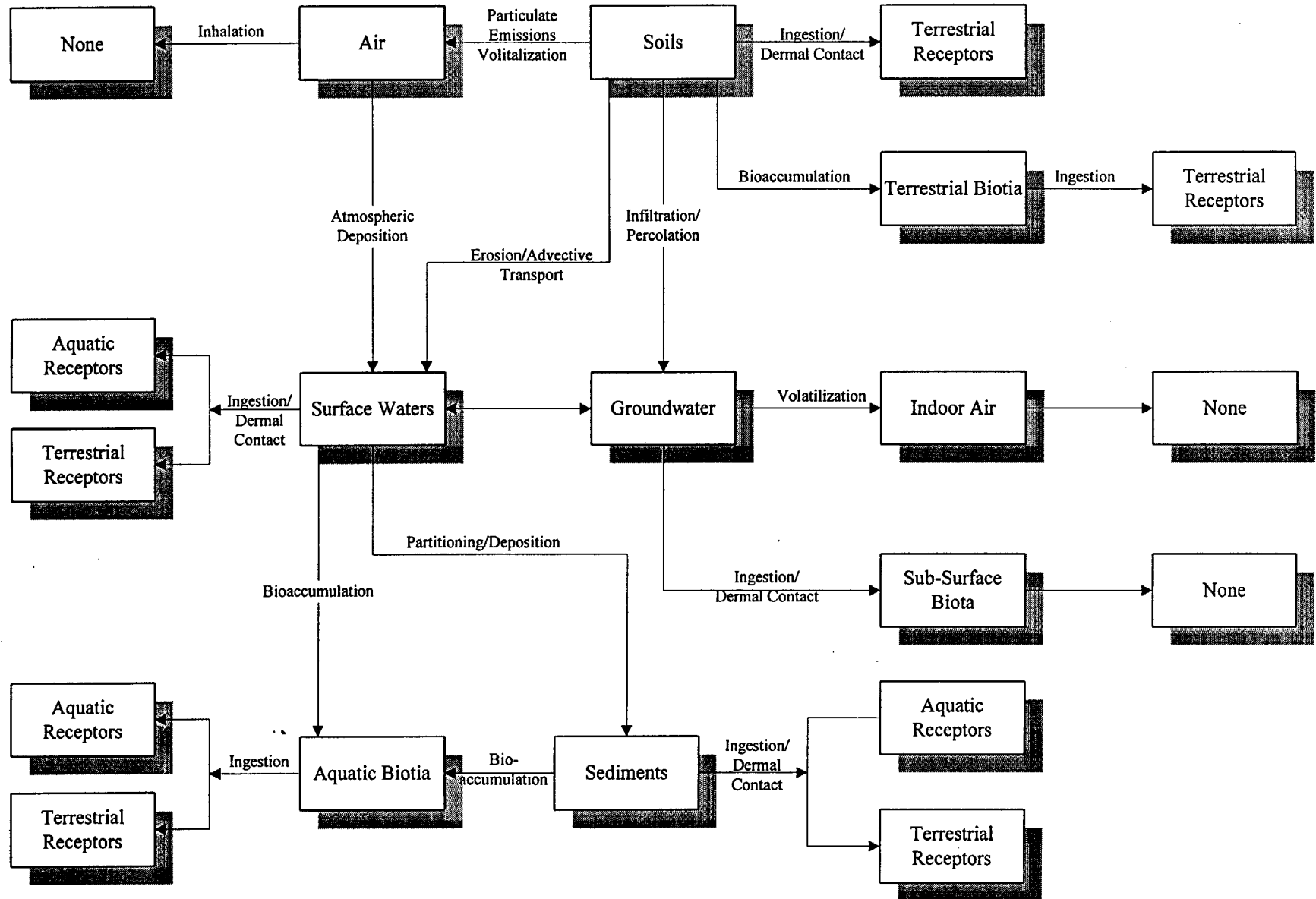
Notes:

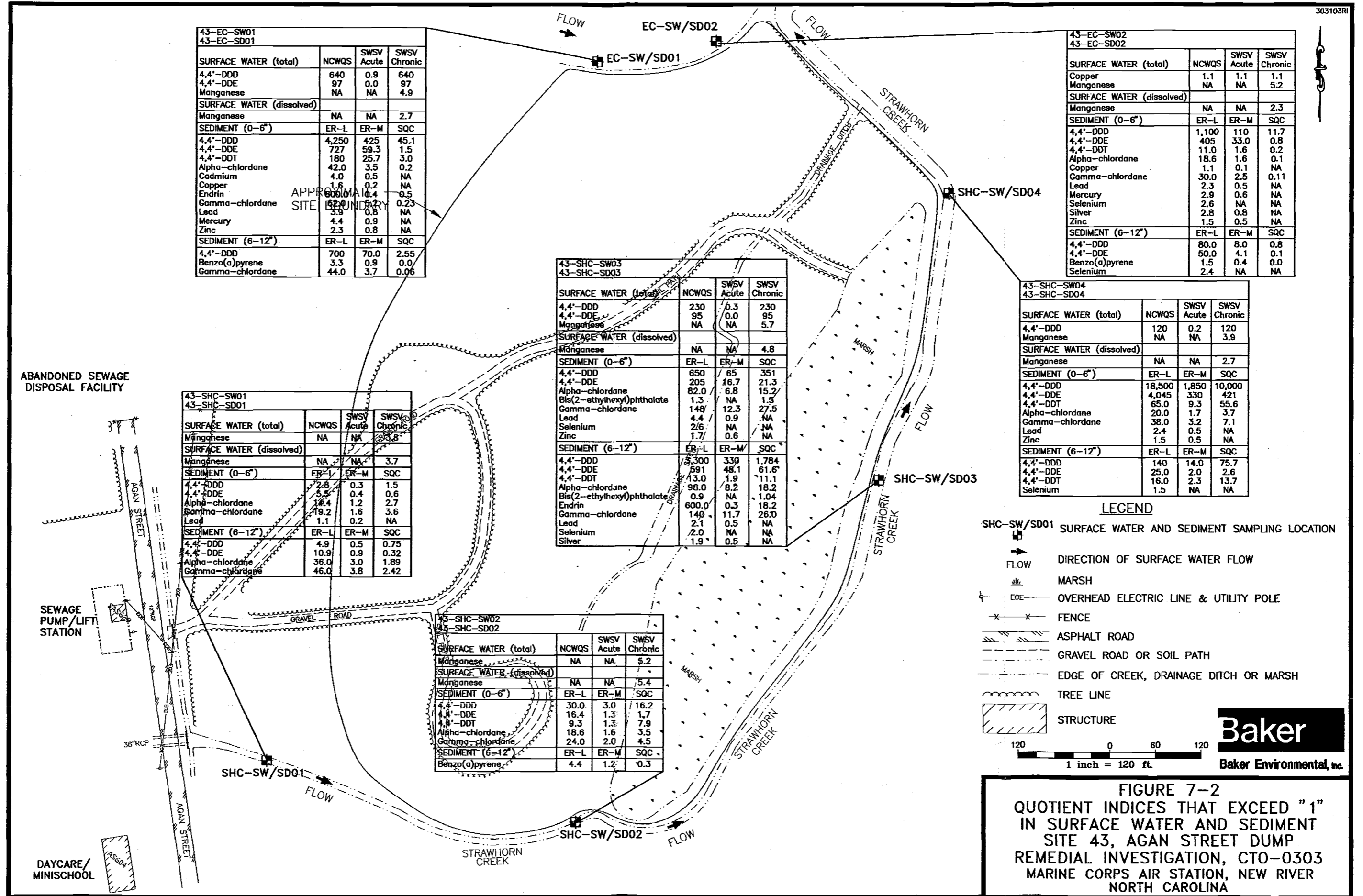
Shaded boxes are Quotient Indices that exceed "1"

SECTION 7.0 FIGURES

FIGURE 7-1

CONCEPTUAL EXPOSURE MODEL FOR ECOLOGICAL RECEPTORS
SITE 43, AGAN STREET DUMP





43-EC-SW01
43-EC-SD01

SURFACE WATER (total)	NCWQS	SWSV Acute	SWSV Chronic
4,4'-DDD	640	0.9	640
4,4'-DDE	97	0.0	97
Manganese	NA	NA	4.9
SURFACE WATER (dissolved)			
Manganese	NA	NA	2.7
SEDIMENT (0-6")			
4,4'-DDD	4,250	425	45.1
4,4'-DDE	727	59.3	1.5
4,4'-DDT	180	25.7	3.0
Alpha-chlordane	42.0	3.5	0.2
Cadmium	4.0	0.5	NA
Copper	1.6	0.2	NA
Endrin	0.6	0.4	0.5
Gamma-chlordane	52.0	5.2	0.23
Lead	3.9	0.8	NA
Mercury	4.4	0.9	NA
Zinc	2.3	0.8	NA
SEDIMENT (6-12")			
4,4'-DDD	700	70.0	2.55
Benzo(a)pyrene	3.3	0.9	0.0
Gamma-chlordane	44.0	3.7	0.06

43-EC-SW02
43-EC-SD02

SURFACE WATER (total)	NCWQS	SWSV Acute	SWSV Chronic
Copper	NA	NA	1.1
Manganese	NA	NA	5.2
SURFACE WATER (dissolved)			
Manganese	NA	NA	2.3
SEDIMENT (0-6")			
4,4'-DDD	1,100	110	11.7
4,4'-DDE	405	33.0	0.8
4,4'-DDT	11.0	1.6	0.2
Alpha-chlordane	18.6	1.6	0.1
Copper	1.1	0.1	NA
Gamma-chlordane	30.0	2.5	0.11
Lead	2.3	0.5	NA
Mercury	2.9	0.6	NA
Selenium	2.6	NA	NA
Silver	2.8	0.8	NA
Zinc	1.5	0.5	NA
SEDIMENT (6-12")			
4,4'-DDD	80.0	8.0	0.8
4,4'-DDE	50.0	4.1	0.1
Benzo(a)pyrene	1.5	0.4	0.0
Selenium	2.4	NA	NA

43-SHC-SW03
43-SHC-SD03

SURFACE WATER (total)	NCWQS	SWSV Acute	SWSV Chronic
4,4'-DDD	230	0.3	230
4,4'-DDE	95	0.0	95
Manganese	NA	NA	5.7
SURFACE WATER (dissolved)			
Manganese	NA	NA	4.8
SEDIMENT (0-6")			
4,4'-DDD	650	65	351
4,4'-DDE	205	16.7	21.3
Alpha-chlordane	82.0	6.8	15.2
Bis(2-ethylhexyl)phthalate	1.3	NA	1.5
Gamma-chlordane	148	12.3	27.5
Lead	4.4	0.9	NA
Selenium	2.6	NA	NA
Zinc	1.7	0.6	NA
SEDIMENT (6-12")			
4,4'-DDD	5,300	339	1,784
4,4'-DDE	591	48.1	61.6
4,4'-DDT	13.0	1.9	11.1
Alpha-chlordane	98.0	8.2	18.2
Bis(2-ethylhexyl)phthalate	0.9	NA	1.04
Endrin	600.0	0.3	18.2
Gamma-chlordane	149	11.7	26.0
Lead	2.1	0.5	NA
Selenium	2.0	NA	NA
Silver	1.9	0.5	NA

43-SHC-SW04
43-SHC-SD04

SURFACE WATER (total)	NCWQS	SWSV Acute	SWSV Chronic
4,4'-DDD	120	0.2	120
Manganese	NA	NA	3.9
SURFACE WATER (dissolved)			
Manganese	NA	NA	2.7
SEDIMENT (0-6")			
4,4'-DDD	18,500	1,850	10,000
4,4'-DDE	4,045	330	421
4,4'-DDT	65.0	9.3	55.6
Alpha-chlordane	20.0	1.7	3.7
Gamma-chlordane	38.0	3.2	7.1
Lead	2.4	0.5	NA
Zinc	1.5	0.5	NA
SEDIMENT (6-12")			
4,4'-DDD	140	14.0	75.7
4,4'-DDE	25.0	2.0	2.6
4,4'-DDT	16.0	2.3	13.7
Selenium	1.5	NA	NA

43-SHC-SW01
43-SHC-SD01

SURFACE WATER (total)	NCWQS	SWSV Acute	SWSV Chronic
Manganese	NA	NA	3.8
SURFACE WATER (dissolved)			
Manganese	NA	NA	3.7
SEDIMENT (0-6")			
4,4'-DDD	2.8	0.3	1.5
4,4'-DDE	5.5	0.4	0.6
Alpha-chlordane	14.4	1.2	2.7
Gamma-chlordane	19.2	1.6	3.6
Lead	1.1	0.2	NA
SEDIMENT (6-12")			
4,4'-DDD	4.9	0.5	0.75
4,4'-DDE	10.9	0.9	0.32
Alpha-chlordane	36.0	3.0	1.89
Gamma-chlordane	46.0	3.8	2.42

43-SHC-SW02
43-SHC-SD02

SURFACE WATER (total)	NCWQS	SWSV Acute	SWSV Chronic
Manganese	NA	NA	5.2
SURFACE WATER (dissolved)			
Manganese	NA	NA	5.4
SEDIMENT (0-6")			
4,4'-DDD	30.0	3.0	16.2
4,4'-DDE	16.4	1.3	1.7
4,4'-DDT	9.3	1.3	7.9
Alpha-chlordane	18.6	1.6	3.5
Gamma-chlordane	24.0	2.0	4.5
SEDIMENT (6-12")			
Benzo(a)pyrene	4.4	1.2	0.3

LEGEND

- SHC-SW/SD01 SURFACE WATER AND SEDIMENT SAMPLING LOCATION
- FLOW DIRECTION OF SURFACE WATER FLOW
- ▨ MARSH
- OEE OVERHEAD ELECTRIC LINE & UTILITY POLE
- x-x FENCE
- ▨ ASPHALT ROAD
- ▨ GRAVEL ROAD OR SOIL PATH
- ▨ EDGE OF CREEK, DRAINAGE DITCH OR MARSH
- ▨ TREE LINE
- ▨ STRUCTURE

120 0 60 120
1 inch = 120 ft

Baker
Baker Environmental, Inc.

FIGURE 7-2
QUOTIENT INDICES THAT EXCEED "1"
IN SURFACE WATER AND SEDIMENT
SITE 43, AGAN STREET DUMP
REMEDIAL INVESTIGATION, CTO-0303
MARINE CORPS AIR STATION, NEW RIVER
NORTH CAROLINA

017134072

8.0 CONCLUSIONS AND RECOMMENDATIONS

8.1 Conclusions

The following conclusions were derived from the RI conducted at Site 43:

- SVOCs, predominantly PAHs, were detected in soil samples obtained at Site 43. The observed PAHs were almost exclusively detected in samples obtained from a cleared area along the site access road. The same samples are believed to contain spiractor grit material from the former sewage disposal facility that was located adjacent to Site 43. Groundwater samples collected from monitoring wells within the same area did not exhibit PAHs. These compounds were evaluated for potential human health risk in soil and did not indicate unacceptable risks. Moreover, the PAHs in soil may generate a potential adverse risk to plant and soil invertebrate receptors.
- Metals present in soil corresponded to areas with buried containers, fill, and graded soil. Metals in soil pose a slight ecological risk to terrestrial receptors. No unacceptable human health risks were calculated from exposure to metals in soil.
- Iron and manganese were found in site groundwater at concentrations above state drinking water standards throughout the site. Of these two constituents, only exposure to iron and aluminum in groundwater generated unacceptable human health risks. As noted in the report, iron and manganese are very common constituents in all media at MCB, Camp Lejeune. Accordingly, their presence is not likely associated with disposal activities at the site.
- Exposure to pesticides in surface water and sediment posed a potential adverse ecological risk. The pesticides are attributed to routine applications which occurred throughout the base and are not due to disposal at the site. The level of copper in surface water also indicated a slight potential risk to ecological receptors.

8.2 Recommendations

The following recommendations are provided based on the RI findings:

- A No Action Record of Decision should be prepared as the preferred remedial alternative.
- All site monitoring wells should be abandoned in accordance with state and federal procedures.